

SOSTEGNI PENISOLE

PENINSULAS SUPPORTS

2021

SOSTEGNI PENISOLA MODERNI

Modern peninsula supports

■ Brix vetro	pag. 4
■ Quadro	pag. 5
■ Wud	pag. 6
■ Shape	pag. 7
■ Cross	pag. 12
■ Swit	pag. 13
■ Vet	pag. 14
■ Torn	pag. 15
■ Tilc	pag. 16
■ Ram	pag. 17
■ Stand	pag. 18
■ Loom	pag. 19
■ Eddy	pag. 20
■ Zed	pag. 21
■ Quod	pag. 22
■ Sten	pag. 23
■ Ong	pag. 24
■ Elementi di fissaggio	pag. 25
Mounting hardware	

SOSTEGNI PENISOLA CLASSICI

Classic peninsula supports

■ Circle.....	pag. 28
■ Bens.....	pag. 29
■ Reil.....	pag. 30
■ Kalim.....	pag. 31
■ Contempo.....	pag. 32
■ Ilan.....	pag. 33
■ Most.....	pag. 34



GAMBONE "BRIX" VETRO

"BRIX" GLASS FINISH SUPPORT



FOTO VETRO EXTRACHIARO

Gambone "BRIX" vetro
"BRIX" glass finish support

Finitura Vetro
Glass finish

CODICE / CODE No.

CODICE / CODE No.

CODICE / CODE No.

Extrachiaro
Extra-clear

Fumè grigio
Smoky grey

Bronzo
Bronze

L 40 H 48	W 40 H 48
L 40 H 49	W 40 H 49
L 40 H 50,5	W 40 H 50,5
L 40 H 54	W 40 H 54
L 40 H 73	W 40 H 73
L 40 H 75	W 40 H 75
L 40 H 76	W 40 H 76
L 40 H 78	W 40 H 78
L 40 H 85	W 40 H 85
L 40 H 87	W 40 H 87
L 40 H 88	W 40 H 88
L 40 H 90	W 40 H 90

08790549
08790551
08790553
08790555
08790559
08790561
08790563
08790567
08790565
08790571
08790573
08790577

08790549F
08790551F
08790553F
08790555F
08790559F
08790561F
08790563F
08790567F
08790565F
08790571F
08790573F
08790577F

08790549B
08790551B
08790553B
08790555B
08790559B
08790561B
08790563B
08790567B
08790565B
08790571B
08790573B
08790577B

L 60 H 48	W 60 H 48
L 60 H 49	W 60 H 49
L 60 H 50,5	W 60 H 50,5
L 60 H 54	W 60 H 54
L 60 H 73	W 60 H 73
L 60 H 75	W 60 H 75
L 60 H 76	W 60 H 76
L 60 H 78	W 60 H 78
L 60 H 85	W 60 H 85
L 60 H 87	W 60 H 87
L 60 H 88	W 60 H 88
L 60 H 90	W 60 H 90

08790550
08790552
08790554
08790556
08790560
08790562
08790564
08790568
08790575
08790572
08790574
08790578

08790550F
08790552F
08790554F
08790556F
08790560F
08790562F
08790564F
08790568F
08790575F
08790572F
08790574F
08790578F

08790550B
08790552B
08790554B
08790556B
08790560B
08790562B
08790564B
08790568B
08790575B
08790572B
08790574B
08790578B

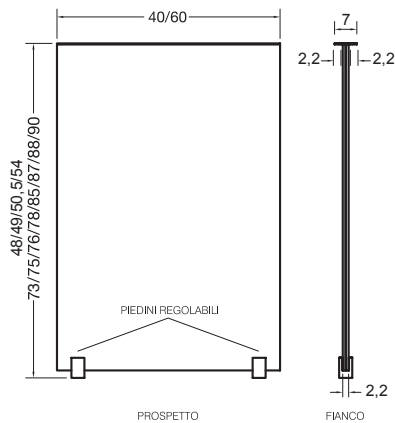

Schema foratura per fissaggio
Drilling diagram for fixing

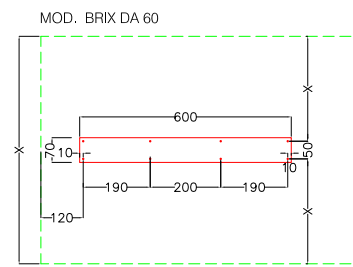
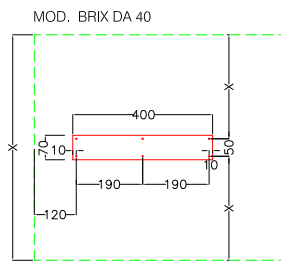

GAMBONE "QUADRO" "QUADRO" SUPPORT



FOTO NERO

Gambone "QUADRO. Colori disponibili telaio vedi pag.11
"QUADRO" support. See available colours frame at pages 11

CODICE / CODE No.

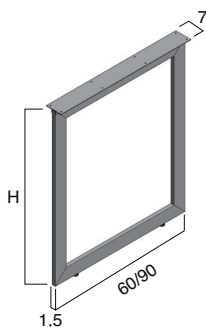

L 60 H 73	W 60 H 73
L 60 H 75	W 60 H 75
L 60 H 76	W 60 H 76
L 60 H 78	W 60 H 78
L 60 H 85	W 60 H 85
L 60 H 88	W 60 H 88
L 60 H 90	W 60 H 90

08790601
08790603
08790605
08790607
08790609
08790611
08790613

L 90 H 73	W 90 H 73
L 90 H 75	W 90 H 75
L 90 H 76	W 90 H 76
L 90 H 78	W 90 H 78
L 90 H 85	W 90 H 85
L 90 H 88	W 90 H 88
L 90 H 90	W 90 H 90

08790602
08790604
08790606
08790608
08790610
08790612
08790614

Schemi foratura per fissaggio
Drilling diagrams for fixing

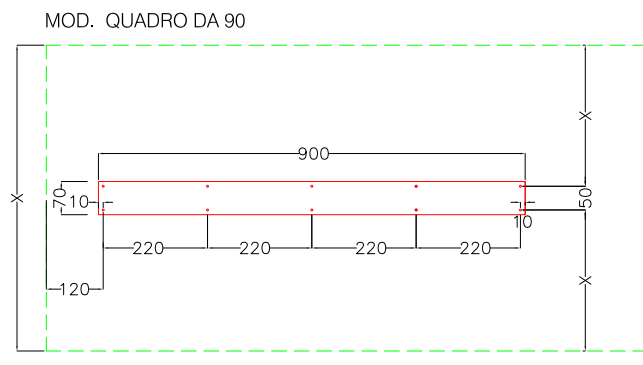
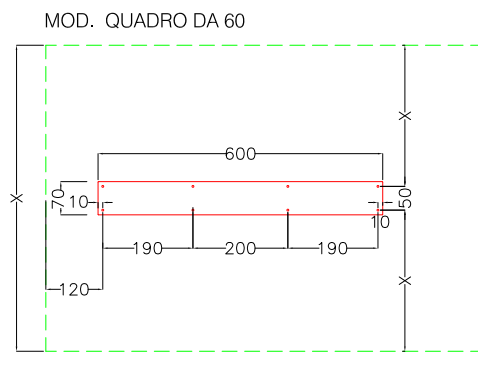

GAMBONE "WUD"

"WUD" SUPPORT



Gambone impiallacciato "WUD" con fiamma verticale o orizzontale (in base alla finitura).

Colori disponibili vedi pag.8-9

"WUD" support veneered with vertical or horizontal grain, (depending on the finish).

See available colours at pages 8-9

CODICE / CODE No.

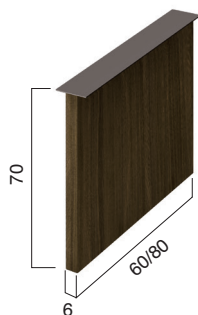

H 70 L 60 H 70 W 60
H 70 L 80 H 70 W 80

08790930
08790940

Schemi foratura per fissaggio

Drilling diagrams for fixing

MOD. WUD DA 60

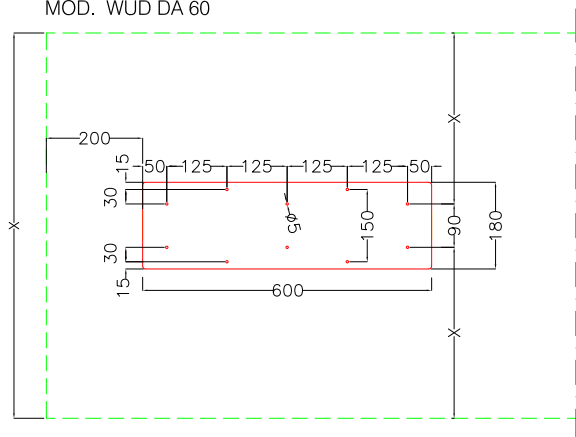

MOD. WUD DA 80

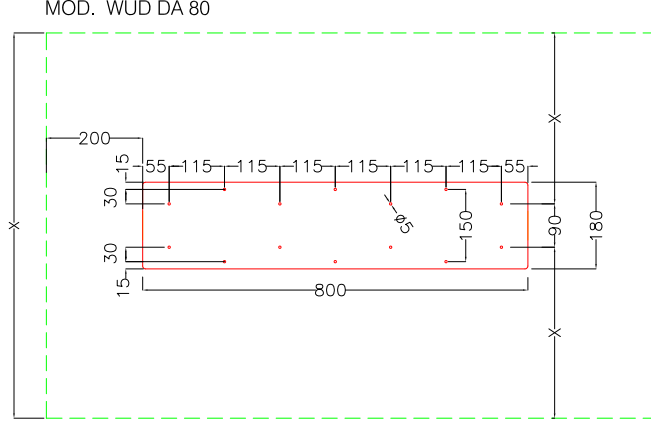

GAMBONE "SHAPE"

"SHAPE" SUPPORT



Gambone "SHAPE" con fiamma verticale o orizzontale (in base alla finitura).
 Colori disponibili pannello vedi pag.8-11. Colori disponibili telaio vedi pag.11
 "SHAPE" support veneered with vertical or horizontal grain, (depending on the finish).
 See available colours panel at pages 8-11. See available colours frame at pages 11

CODICE / CODE No.

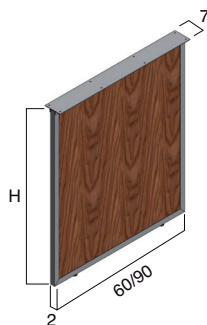

L 60 H 73	W 60 H 73
L 60 H 75	W 60 H 75
L 60 H 76	W 60 H 76
L 60 H 78	W 60 H 78
L 60 H 85	W 60 H 85
L 60 H 88	W 60 H 88
L 60 H 90	W 60 H 90

0879SH01
0879SH03
0879SH05
0879SH07
0879SH09
0879SH11
0879SH13

L 90 H 73	W 90 H 73
L 90 H 75	W 90 H 75
L 90 H 76	W 90 H 76
L 90 H 78	W 90 H 78
L 90 H 85	W 90 H 85
L 90 H 88	W 90 H 88
L 90 H 90	W 90 H 90

0879SH02
0879SH04
0879SH06
0879SH08
0879SH10
0879SH12
0879SH14

Schemi foratura per fissaggio
 Drilling diagrams for fixing

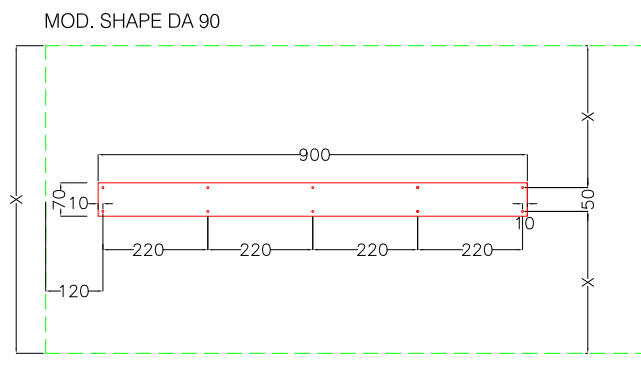
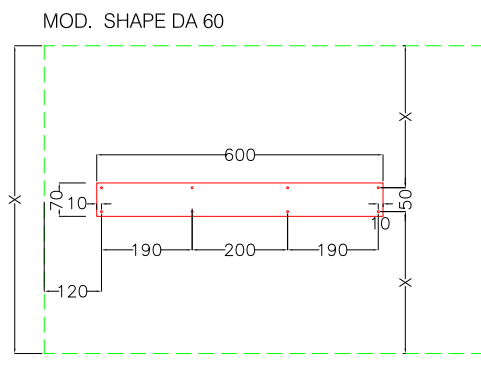

FINITURE IMPIALLACCiate PER SOSTEGNI "WUD" E "SHAPE" VENEERED FINISHES FOR "WUD" AND "SHAPE" SUPPORTS

MODELLO CLOVER CLOVER MODEL



rovere grigio nebbia (opz.5401), fiamma verticale
 mist grey oak (opt.5401), vertical grain

rovere polvere (opz.5402), fiamma verticale
 dust oak (opt.5402), vertical grain

rovere grafite (opz.5403), fiamma verticale
 graphite oak (opt.5403), vertical grain

rovere naturale (opz.5404), fiamma verticale
 natural oak (opt.5404), vertical grain

rovere sahara (opz.5416), fiamma orizzontale
 sahara oak (opt.5416), horizontal grain

rovere visone (opz.5417), fiamma orizzontale
 mink oak (opt.5417), horizontal grain

rovere grigio cenere (opz.5418), fiamma orizzontale
 ash grey oak (opt.5418), horizontal grain

rovere lavagna (opz.5419), fiamma orizzontale
 slate grey oak (opt.5419), horizontal grain

rovere tabacco (opz.5405), fiamma verticale
 tobacco oak (opt.5405), vertical grain

rovere bianco (opz.5415), fiamma orizzontale
 white oak (opt.5415), horizontal grain

rovere nero (opz.5420), fiamma orizzontale
 black oak (opt.5420), horizontal grain

rovere tan (opz.5408) fiamma verticale, senza nodo
 tan oak (opt.5408), vertical grain, without knots

rovere cenere (opz.5409) fiamma verticale, senza nodo
 ash oak (opt.5409), vertical grain, without knots

noce canaletto (opz.1324), fiamma verticale
 canaletto walnut (opt.1324), vertical grain

rovere termocotto (opz.5410), fiamma verticale
 thermo-treated oak (opt.5410), vertical grain

MODELLO LUNA LUNA MODEL



rovere bianco (opz.5429), fiamma orizzontale
 white oak (opt.5429), horizontal grain

rovere grigio reale (opz.5432), fiamma orizzontale
 royal grey oak (opt.5432), horizontal grain

rovere grigio traffico (opz.5431), fiamma orizzontale
 traffic grey oak (opt.5431), horizontal grain

rovere carbon (opz.5434) fiamma orizzontale
 carbon oak (opt.5434), horizontal grain

rovere lino (opz.5430) fiamma orizzontale
 linen oak (opt.5430), horizontal grain

rovere moresco (opz.5433) fiamma orizzontale
 moresco oak (opt.5433), horizontal grain

rovere natur (opz.5440) fiamma orizzontale
 natur oak (opt.5440), horizontal grain

noce canaletto (opz.1331) fiamma orizzontale
 canaletto walnut (opt.1331), horizontal grain

FINITURE IMPIALLACCiate PER SOSTEGNI "WUD" E "SHAPE" VENEERED FINISHES FOR "WUD" AND "SHAPE" SUPPORTS

MODELLO OLTRE OLTRE MODEL



rovere bianco invecchiato
 (opz.5380)
 white aged oak (opt.5380)



rovere juta invecchiato
 (opz.5381)
 jute aged oak (opt.5381)



rovere corteccia invecchiato
 (opz.5382)
 bark aged oak (opt.5382)



rovere mielato invecchiato
 (opz.5383)
 honey aged oak (opt.5383)

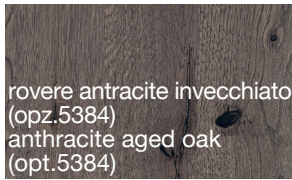

rovere antracite invecchiato
 (opz.5384)
 anthracite aged oak
 (opt.5384)



rovere argilla invecchiato
 (opz.5385)
 clay aged oak (opt.5385)



rovere moro invecchiato
 (opz.5386)
 dark aged oak (opt.5386)

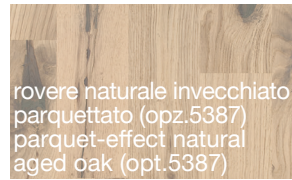

rovere naturale invecchiato
 parquetto (opz.5387)
 parquet-effect natural
 aged oak (opt.5387)

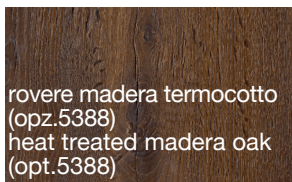

rovere maderia termocotto
 (opz.5388)
 heat treated maderia oak
 (opt.5388)



rovere grigio terra
 (opz.5389)
 grey earth oak (opt.5389)

MODELLO FLAVOUR FLAVOUR MODEL



frassino grigio reale
 (opz.2450)
 royal grey ash (opt.2450)

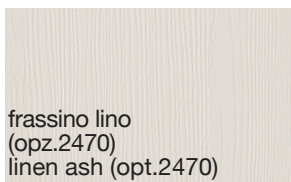

frassino lino
 (opz.2470)
 linen ash (opt.2470)

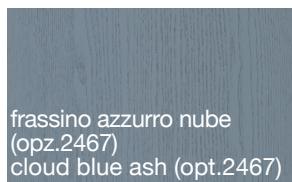

frassino azzurro nube
 (opz.2467)
 cloud blue ash (opt.2467)

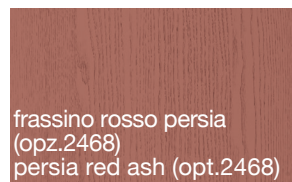

frassino rosso persia
 (opz.2468)
 persia red ash (opt.2468)



rovere cuoio (opz.5379)
 leather oak (opt.5379)



rovere mielato (opz.5377)
 honey oak (opt.5377)

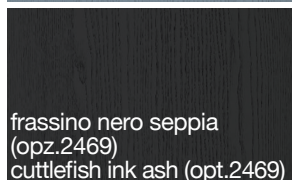

frassino nero seppia
 (opz.2469)
 cuttlefish ink ash (opt.2469)

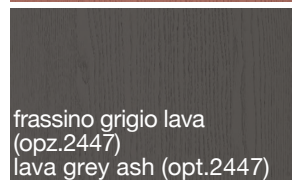

frassino grigio lava
 (opz.2447)
 lava grey ash (opt.2447)

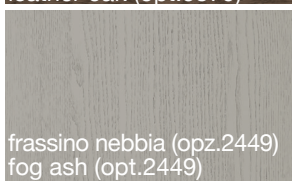

frassino nebbia (opz.2449)
 fog ash (opt.2449)

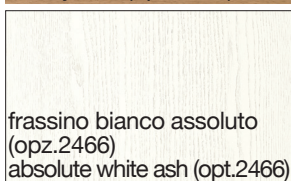

frassino bianco assoluto
 (opz.2466)
 absolute white ash (opt.2466)



rovere nuvola (opz.5375)
 cloud oak (opt.5375)

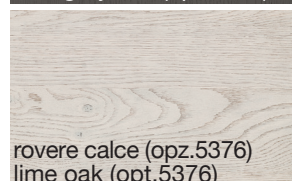

rovere calce (opz.5376)
 lime oak (opt.5376)



rovere asfalto (opz.5378)
 asphalt oak (opt.5378)

FINITURE MELAMINICHE PER SOSTEGNO "SHAPE" MELAMINE FINISHES FOR "SHAPE" SUPPORT

MODELLO IMMAGINA PLUS IMMAGINA PLUS MODEL

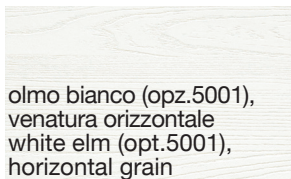

olmo bianco (opz.5001),
venatura orizzontale
white elm (opt.5001),
horizontal grain

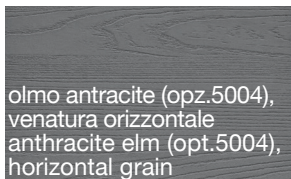

olmo antracite (opz.5004),
venatura orizzontale
anthracite elm (opt.5004),
horizontal grain



abete bianco
(opz.4401)
white fir (opt.4401)



larice baglia
(opz.1826)
baglia larch (opt.1826)



oak miele
(opz.1361)
honey oak (opt.1361)

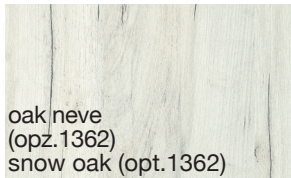

oak neve
(opz.1362)
snow oak (opt.1362)



oak cognac
(opz.1363)
cognac oak (opt.1363)



cansiglio bianco
(opz.1561)
cansiglio white (opt.1561)



cansiglio terra
bruciata (opz.1562)
cansiglio scorched earth
(opt.1562)



cansiglio grigio
fumo (opz.1563)
cansiglio smoke grey
(opt.1563)



cansiglio sabbia
(opz.1564)
cansiglio sand (opt.1564)

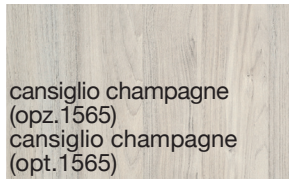

cansiglio champagne
(opz.1565)
cansiglio champagne
(opt.1565)

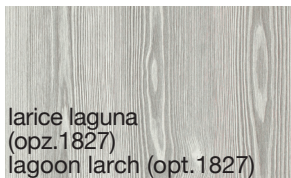

larice laguna
(opz.1827)
lagoon larch (opt.1827)



larice vulcano
(opz.1828)
volcano larch (opt.1828)



larice terra
(opz.1829)
earth larch (opt.1829)

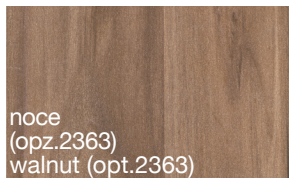

noce
(opz.2363)
walnut (opt.2363)

MODELLO TABLET TABLET MODEL



rovere luna
(opz.5316)
moon oak (opt.5316)

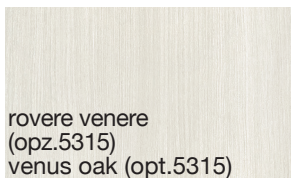

rovere venere
(opz.5315)
venus oak (opt.5315)

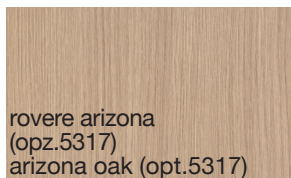

rovere arizona
(opz.5317)
arizona oak (opt.5317)

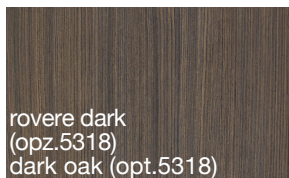

rovere dark
(opz.5318)
dark oak (opt.5318)

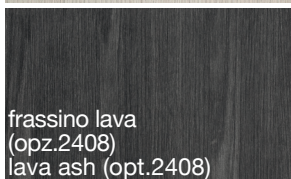

frassino lava
(opz.2408)
lava ash (opt.2408)



frassino sabbia
(opz.2406)
sand ash (opt.2406)

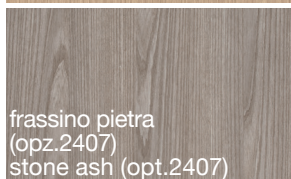

frassino pietra
(opz.2407)
stone ash (opt.2407)

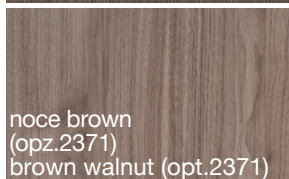

noce brown
(opz.2371)
brown walnut (opt.2371)

MODELLO JEY FEEL JEY FEEL MODEL

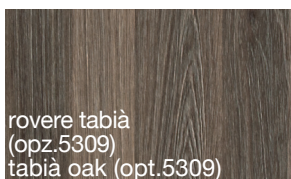

rovere tabià
(opz.5309)
tabià oak (opt.5309)



rovere ortisei
(opz.5305)
ortisei oak (opt.5305)



rovere silver
(opz.5306)
silver oak (opt.5306)



rovere diamond
(opz.5307)
diamond oak (opt.5307)

FINITURE ALKORCELL PER SOSTEGNO "SHAPE" ALKORCELL FINISHES FOR "SHAPE" SUPPORT

MODELLO SMART SMART MODEL

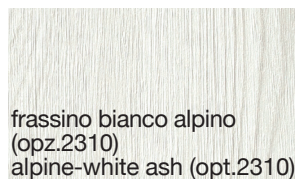

frassino bianco alpino
(opz.2310)
alpine-white ash (opt.2310)



betulla (opz.2311)
birch (opt.2311)



rovere greige (opz.2320)
greige oak (opt.2320)

FINITURE TELAIO PER SOSTEGNO "SHAPE" E "QUADRO" FRAME FINISHES FOR "SHAPE" AND "QUADRO" SUPPORTS

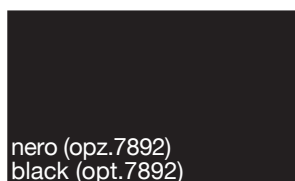

nero (opz.7892)
black (opt.7892)

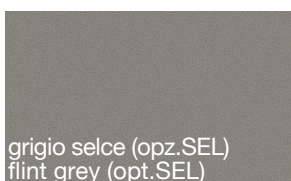

grigio selce (opz.SEL)
flint grey (opt.SEL)

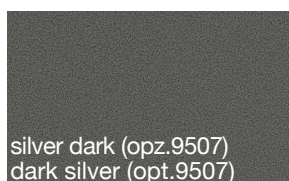

silver dark (opz.9507)
dark silver (opt.9507)

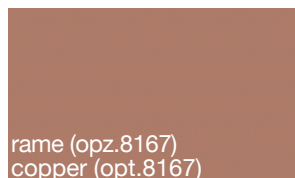

rame (opz.8167)
copper (opt.8167)

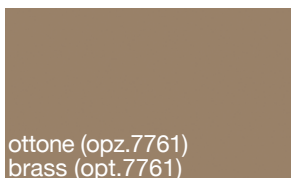

ottone (opz.7761)
brass (opt.7761)

GAMBONE "CROSS"

"CROSS" SUPPORT



FOTO GRIGIO SELCE

Gambone "CROSS". Colori disponibili vedi pag.26
 "CROSS" support. See available colours at page 26

CODICE / CODE No.

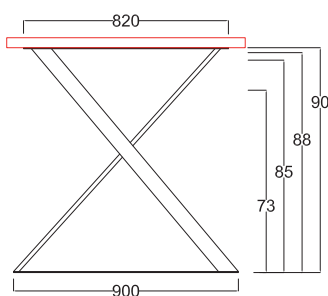
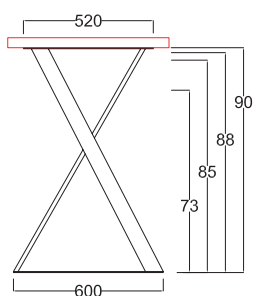

L 60 H 73 W 60 H 73
 L 60 H 85 W 60 H 85
 L 60 H 88 W 60 H 88
 L 60 H 90 W 60 H 90

L 90 H 73 W 90 H 73
 L 90 H 85 W 90 H 85
 L 90 H 88 W 90 H 88
 L 90 H 90 W 90 H 90

08791282
08791284
08791288
08791290

08791283
08791285
08791289
08791291

Schemi foratura per fissaggio
 Drilling diagrams for fixing

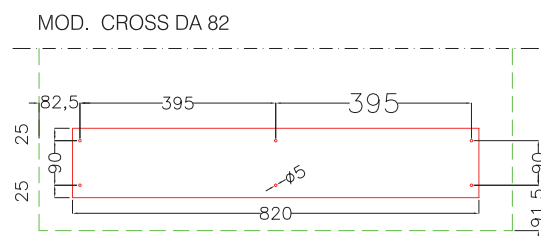
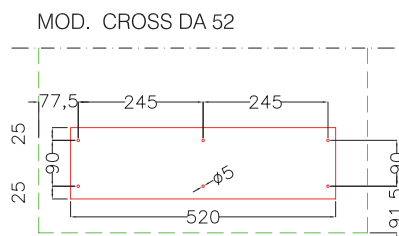

GAMBONE "SWIT"

"SWIT" SUPPORT



FOTO TITANIO

Gambone "SWIT" finitura laccata opaca verniciata a polvere. Colori vedi pag.27
 "SWIT" support, matt powder coated finish. See colours at page 27

CODICE / CODE No.

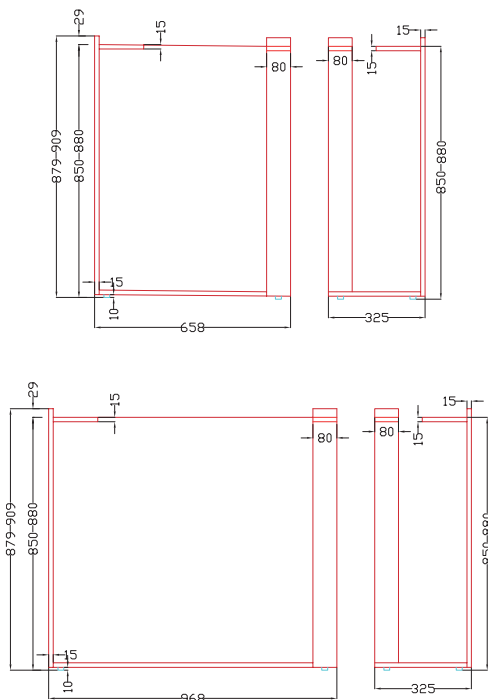

Finiture colori:
 grigio selce/silver dark/nero/
 titanio/bianco assoluto

Colours finishes:
 flint grey/dark silver/black/
 absolute white/titanium

- | | | |
|-------------|-------------|-----------------|
| L 65,8 H 85 | W 65,8 H 85 | 08790951 |
| L 65,8 H 88 | W 65,8 H 88 | 08790956 |
| L 65,8 H 90 | W 65,8 H 90 | 08790958 |
| L 96,8 H 85 | W 96,8 H 85 | 08790950 |
| L 96,8 H 88 | W 96,8 H 88 | 08790955 |
| L 96,8 H 90 | W 96,8 H 90 | 08790957 |

Schemi foratura per fissaggio
 Drilling diagrams for fixing

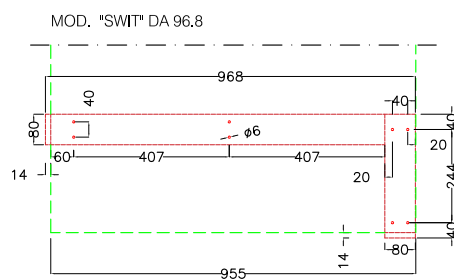
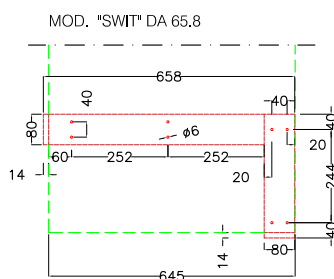

GAMBONE "VET"

"VET" SUPPORT



FOTO BIANCO ASSOLUTO

Gambone "VET" finitura laccata opaca verniciata a polvere. Colori vedi pag.27
 "VET" support, painted powder matt lacquered finish. See colours at page 27

CODICE / CODE No.

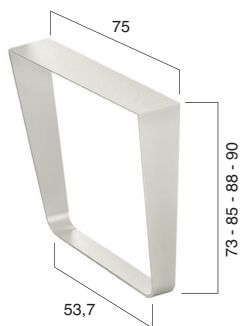

Finiture colori:
 grigio selce/silver dark/nero/
 titanio/bianco assoluto

Colours finishes:
 flint grey/dark silver/black/
 absolute white/titanium

H 73
 H 85
 H 88
 H 90

08790300
08790304
08790306
08790307

Schema foratura per fissaggio
 Drilling diagram for fixing

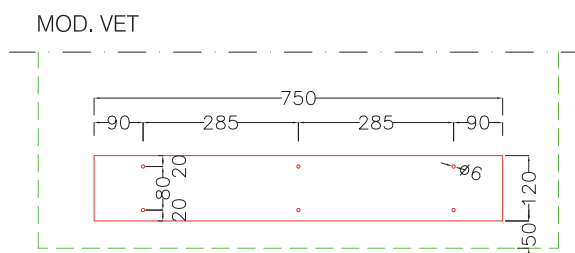

GAMBONE "TORN"

"TORN" SUPPORT



FOTO NERO

Gambone regolabile "TORN" finitura laccata opaca verniciata a polvere. Colori vedi pag.27
 "TORN" adjustable support painted powder matt lacquered finish. See colours at page 27

CODICE / CODE No.

<p>min.73 - max.78 min.85 - max.95</p> <p>PROSPETTO</p> <p>FIANCO</p>	<p>Finitura orione Orion finish</p> <p>L 59 H 73 min. - H 78 max W 59 H 73 min. - H 78 max.</p> <p>L 80 H 73 min. - H 78 max W 80 H 73 min. - H 78 max.</p> <p>08790804R 08790904R</p>
	<p>L 59 H 85 min. - H 95 max W 59 H 85 min. - H 95 max.</p> <p>L 80 H 85 min. - H 95 max W 80 H 85 min. - H 95 max.</p> <p>08790801R 08790901R</p>
	<p>Finitura grigio selce Flint grey finish</p> <p>L 59 H 73 min. - H 78 max W 59 H 73 min. - H 78 max.</p> <p>L 80 H 73 min. - H 78 max W 80 H 73 min. - H 78 max.</p> <p>08790804S 08790904S</p>
	<p>L 59 H 85 min. - H 95 max W 59 H 85 min. - H 95 max.</p> <p>L 80 H 85 min. - H 95 max W 80 H 85 min. - H 95 max.</p> <p>08790801S 08790901S</p>
	<p>Finitura nero Black finish</p> <p>L 59 H 73 min. - H 78 max W 59 H 73 min. - H 78 max.</p> <p>L 80 H 73 min. - H 78 max W 80 H 73 min. - H 78 max.</p> <p>08790804 08790904</p>
	<p>L 59 H 85 min. - H 95 max W 59 H 85 min. - H 95 max.</p> <p>L 80 H 85 min. - H 95 max W 80 H 85 min. - H 95 max.</p> <p>08790801 08790901</p>

Schemi foratura per fissaggio

Drilling diagrams for fixing

MOD. TORN DA 59

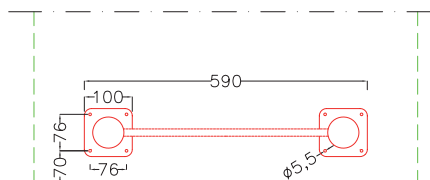

MOD. TORN DA 80

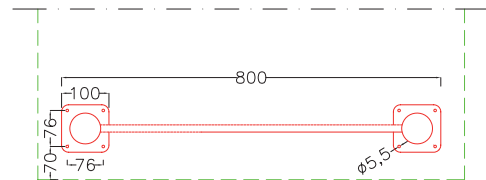

GAMBONE "TILC"

"TILC" SUPPORT



FOTO GRIGIO SELCE

Gambone "TILC" finitura laccata opaca verniciata a polvere. Colori vedi pag.27
 "TILC" support, painted powder matt lacquered finish. See colours at page 27

CODICE / CODE No.

Finitura nero	Black finish
L 70 H 71 min. - H 85 max	W 70 H 71 min. - H 85 max.
L 80 H 71 min. - H 85 max	W 80 H 71 min. - H 85 max.
L 90 H 71 min. - H 85 max	W 90 H 71 min. - H 85 max.
L 70 H 85 min. - H 95 max	W 70 H 85 min. - H 95 max.
L 80 H 85 min. - H 95 max	W 80 H 85 min. - H 95 max.
L 90 H 85 min. - H 95 max	W 90 H 85 min. - H 95 max.

08791103
08791113
08791123

08791153
08791163
08791173

Finitura grigio selce	Flint grey finish
L 70 H 71 min. - H 85 max	W 70 H 71 min. - H 85 max.
L 80 H 71 min. - H 85 max	W 80 H 71 min. - H 85 max.
L 90 H 71 min. - H 85 max	W 90 H 71 min. - H 85 max.
L 70 H 85 min. - H 95 max	W 70 H 85 min. - H 95 max.
L 80 H 85 min. - H 95 max	W 80 H 85 min. - H 95 max.
L 90 H 85 min. - H 95 max	W 90 H 85 min. - H 95 max.

08791102
08791112
08791122

08791152
08791162
08791172

Finitura bronzo titanio	Titanium bronze finish
L 70 H 71 min. - H 85 max	W 70 H 71 min. - H 85 max.
L 80 H 71 min. - H 85 max	W 80 H 71 min. - H 85 max.
L 90 H 71 min. - H 85 max	W 90 H 71 min. - H 85 max.
L 70 H 85 min. - H 95 max	W 70 H 85 min. - H 95 max.
L 80 H 85 min. - H 95 max	W 80 H 85 min. - H 95 max.
L 90 H 85 min. - H 95 max	W 90 H 85 min. - H 95 max.

08791104
08791114
08791124

08791154
08791164
08791174

Finitura silver dark	Dark silver finish
L 70 H 71 min. - H 85 max	W 70 H 71 min. - H 85 max.
L 80 H 71 min. - H 85 max	W 80 H 71 min. - H 85 max.
L 90 H 71 min. - H 85 max	W 90 H 71 min. - H 85 max.
L 70 H 85 min. - H 95 max	W 70 H 85 min. - H 95 max.
L 80 H 85 min. - H 95 max	W 80 H 85 min. - H 95 max.
L 90 H 85 min. - H 95 max	W 90 H 85 min. - H 95 max.

08791105
08791115
08791125

08791155
08791165
08791175

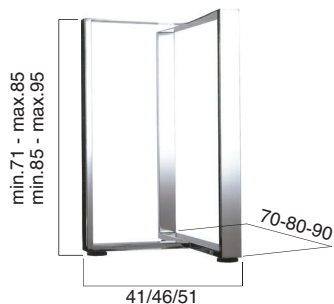

Schemi foratura per fissaggio

Drilling diagrams for fixing

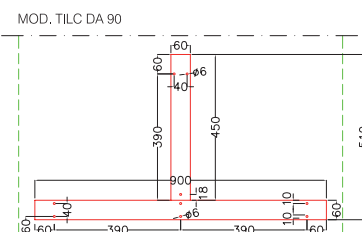
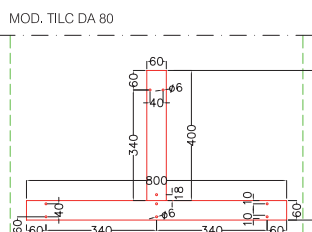
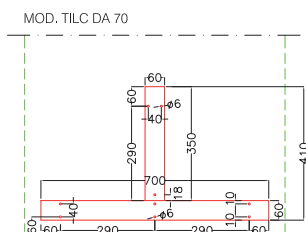

GAMBONE "RAM"

"RAM" SUPPORT



FOTO TITANIO OSSIDATO

Gambone "RAM". Colori vedi pag.27
"RAM" support. See colours at page 27

CODICE / CODE No.

Finitura alluminio brill lucido Glossy brill aluminium finish
 L 63 H 71 min. - H 85 max W 63 H 71 min. - H 85 max.
 L 79 H 71 min. - H 85 max W 79 H 71 min. - H 85 max.
 L 121 H 71 min. - H 85 max W 121 H 71 min. - H 85 max.

08791000
08791010
08791020

L 63 H 85 min. - H 95 max W 63 H 85 min. - H 95 max.
 L 79 H 85 min. - H 95 max W 79 H 85 min. - H 95 max.
 L 121 H 85 min. - H 95 max W 121 H 85 min. - H 95 max.

08791050
08791060
08791070

Finitura titanio ossidato Titanium oxidized finish
 L 63 H 71 min. - H 85 max W 63 H 71 min. - H 85 max.
 L 79 H 71 min. - H 85 max W 79 H 71 min. - H 85 max.
 L 121 H 71 min. - H 85 max W 121 H 71 min. - H 85 max.

08791001
08791011
08791021

L 63 H 85 min. - H 95 max W 63 H 85 min. - H 95 max.
 L 79 H 85 min. - H 95 max W 79 H 85 min. - H 95 max.
 L 121 H 85 min. - H 95 max W 121 H 85 min. - H 95 max.

08791051
08791061
08791071

Finitura grigio selce Flint grey finish
 L 63 H 71 min. - H 85 max W 63 H 71 min. - H 85 max.
 L 79 H 71 min. - H 85 max W 79 H 71 min. - H 85 max.
 L 121 H 71 min. - H 85 max W 121 H 71 min. - H 85 max.

08791004
08791014
08791024

L 63 H 85 min. - H 95 max W 63 H 85 min. - H 95 max.
 L 79 H 85 min. - H 95 max W 79 H 85 min. - H 95 max.
 L 121 H 85 min. - H 95 max W 121 H 85 min. - H 95 max.

08791054
08791064
08791074

Finitura silver dark Dark silver finish
 L 63 H 71 min. - H 85 max W 63 H 71 min. - H 85 max.
 L 79 H 71 min. - H 85 max W 79 H 71 min. - H 85 max.
 L 121 H 71 min. - H 85 max W 121 H 71 min. - H 85 max.

08791005
08791015
08791025

L 63 H 85 min. - H 95 max W 63 H 85 min. - H 95 max.
 L 79 H 85 min. - H 95 max W 79 H 85 min. - H 95 max.
 L 121 H 85 min. - H 95 max W 121 H 85 min. - H 95 max.

08791055
08791065
08791075

Finitura nero Black finish
 L 63 H 71 min. - H 85 max W 63 H 71 min. - H 85 max.
 L 79 H 71 min. - H 85 max W 79 H 71 min. - H 85 max.
 L 121 H 71 min. - H 85 max W 121 H 71 min. - H 85 max.

08791003
08791013
08791023

L 63 H 85 min. - H 95 max W 63 H 85 min. - H 95 max.
 L 79 H 85 min. - H 95 max W 79 H 85 min. - H 95 max.
 L 121 H 85 min. - H 95 max W 121 H 85 min. - H 95 max.

08791053
08791063
08791073



min.71 - max.85
min.85 - max.95

Schemi foratura per fissaggio
Drilling diagrams for fixing

MOD. RAM DA 63

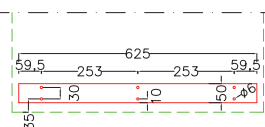

MOD. RAM DA 79

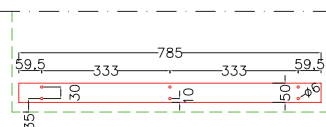

MOD. RAM DA 121

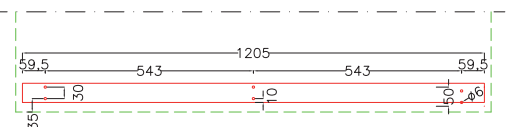

GAMBONE "STAND"

"STAND" SUPPORT



FOTO NERO

Gambone "STAND" finitura laccata opaca verniciata a polvere. Colori vedi pag.27
 "STAND" support, painted powder matt lacquered finish. See colours at page 27

CODICE / CODE No.

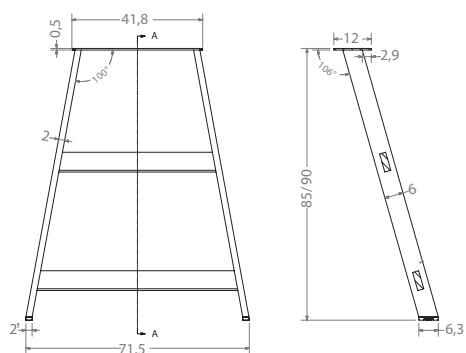

bronzo titanio titanium bronze
 da H 85 a 90 from H 85 to 90

08790242

nero black
 da H 85 a 90 from H 85 to 90

08790246

grigio selce flint grey
 da H 85 a 90 from H 85 to 90

08790243

silver dark dark silver
 da H 85 a 90 from H 85 to 90

08790247

Schema foratura per fissaggio
 Drilling diagram for fixing

MOD. STAND

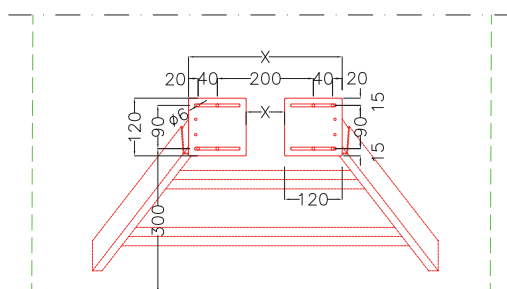

GAMBONE "LOOM"

"LOOM" SUPPORT



FOTO SILVER DARK

Gambone regolabile "LOOM" finitura laccata opaca verniciata a polvere.
 Colori disponibili vedi pag.26-27
 "LOOM" adjustable support powder painted matt lacquered finish.
 See available colours at page 26-27

CODICE / CODE No.

**NERO
 GRIGIO SELCE
 SILVER DARK
 E VERNICIATI
 COLORI FREDDI
 FASCIA "A"**

**COLORI
 LACCATI E
 VERNICIATI A
 POLVERE
 CALDI
 FASCIA "B"**

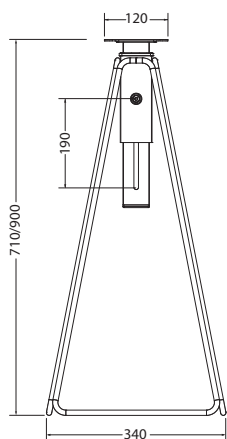

da H 71 a 90 from H 71 to 90

08791320

Schema foratura per fissaggio
 Drilling diagram for fixing

MOD. LOOM

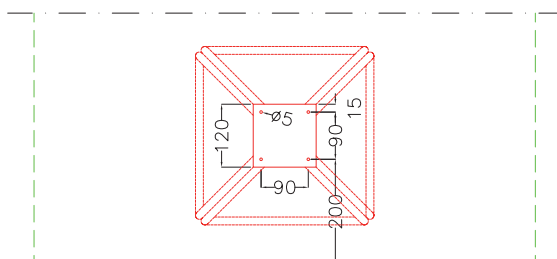

GAMBONE "EDDY" PER BANCONE SNACK

"EDDY" SNACK COUNTER SUPPORT



FOTO SILVER DARK

Gambone "EDDY" per bancone snack. Colori vedi pag.27
 "EDDY" support for snack counter. See colours at page 27

CODICE / CODE No.

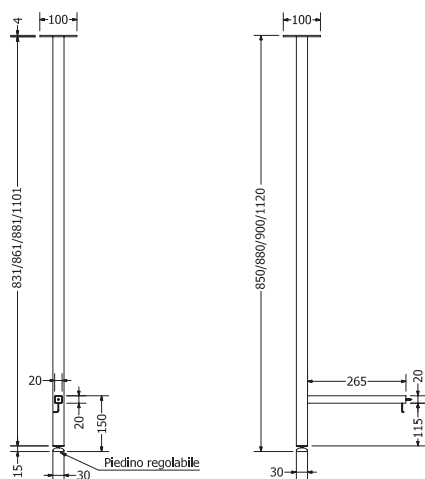

Finitura verniciato alluminio
 Painted aluminium finish

H 85 **08790218**
 H 88 **08790219**
 H 90 **08790221**
 H 112 **08790220**

Finiture verniciati a polvere:
 grigio selce/silver dark/nero/
 bianco assoluto/titanio

Painted powder finishes:
 flint grey/dark silver/black/
 absolute white/titanium

H 85 **08790215**
 H 88 **08790216**
 H 90 **08790214**
 H 112 **08790217**

Schemi foratura per fissaggio
 Drilling diagrams for fixing

MOD. EDDY



GAMBONE "ZED"

"ZED" SUPPORT



FOTO CROMO

Gambone regolabile "ZED". Colori vedi pag.27
 "ZED" adjustable support. See colours at page 27

CODICE / CODE No.



da H 73 a 88
 bianco assoluto
 orione
 grigio selce
 acciaio soft

from H 73 to 88
 absolute white
 orion
 flint grey
 soft steel

08800096
0880096R
0880096S
08800099

Schema foratura per fissaggio
 Drilling diagram for fixing

MOD. ZED

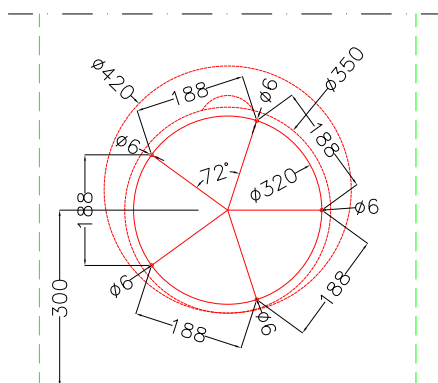

GAMBONE "QUOD"

"QUOD" SUPPORT



FOTO TITANIO OSSIDATO

Gambone "QUOD". Colori vedi pag.27
"QUOD" support. See colours at page 27

CODICE / CODE No.

Finitura titanio ossidato Titanium oxidized finish
L 59 H 73 min. - H 78 max W 59 H 73 min. - H 78 max.
L 80 H 73 min. - H 78 max W 80 H 73 min. - H 78 max.

08791201
08791211

L 59 H 85 min. - H 95 max W 59 H 85 min. - H 95 max.
L 80 H 85 min. - H 95 max W 80 H 85 min. - H 95 max.

08791251
08791261

Finitura grigio selce Flint grey finish
L 59 H 73 min. - H 78 max W 59 H 73 min. - H 78 max.
L 80 H 73 min. - H 78 max W 80 H 73 min. - H 78 max.

08791202
08791212

L 59 H 85 min. - H 95 max W 59 H 85 min. - H 95 max.
L 80 H 85 min. - H 95 max W 80 H 85 min. - H 95 max.

08791252
08791262

Finitura silver dark Dark silver finish
L 59 H 73 min. - H 78 max W 59 H 73 min. - H 78 max.
L 80 H 73 min. - H 78 max W 80 H 73 min. - H 78 max.

08791204
08791214

L 59 H 85 min. - H 95 max W 59 H 85 min. - H 95 max.
L 80 H 85 min. - H 95 max W 80 H 85 min. - H 95 max.

08791254
08791264

Finitura nero Black finish
L 59 H 73 min. - H 78 max W 59 H 73 min. - H 78 max.
L 80 H 73 min. - H 78 max W 80 H 73 min. - H 78 max.

08791203
08791213

L 59 H 85 min. - H 95 max W 59 H 85 min. - H 95 max.
L 80 H 85 min. - H 95 max W 80 H 85 min. - H 95 max.

08791253
08791263

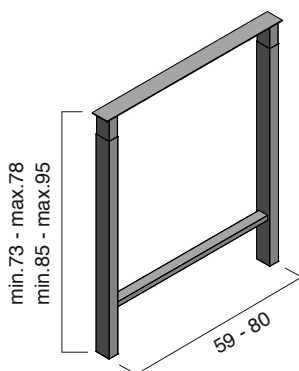

Schemi foratura per fissaggio
Drilling diagrams for fixing

MOD. QUAD DA 59

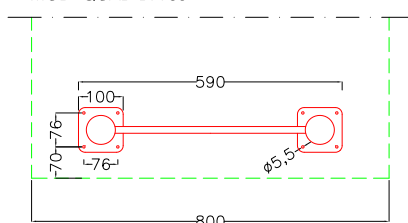

MOD. QUAD DA 80

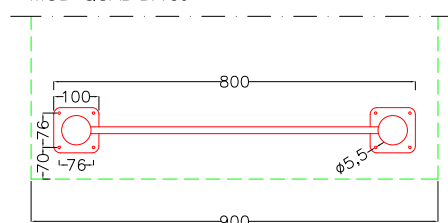

GAMBONE "STEN"

"STEN" SUPPORT



FOTO GRIGIO SELCE

Gambone regolabile "STEN". Colori vedi pag.27
 "STEN" adjustable support. See colours at page 27

CODICE / CODE No.

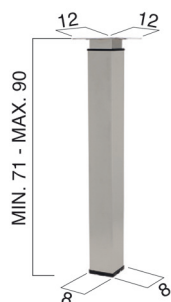

bianco assoluto
 nero
 silver dark
 grigio selce

absolute white
 black
 dark silver
 flint grey

08790182
08790183
08790187
08790188

Schema foratura per fissaggio
 Drilling diagram for fixing

MOD. STEN

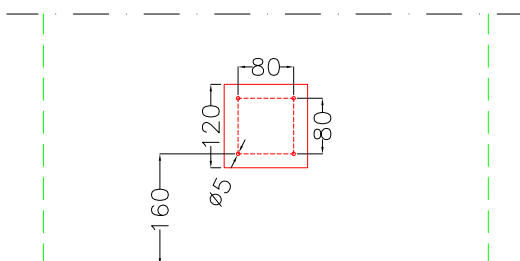

GAMBONE "ONG"

"ONG" SUPPORT



FOTO GRIGIO SELCE

Gambone regolabile "ONG". Colori vedi pag.27
 "ONG" adjustable support. See colours at page 27

CODICE / CODE No.

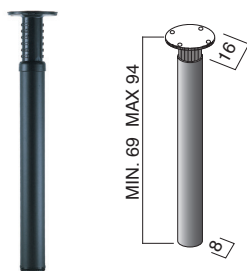

alluminio brill lucido	glossy brill aluminum
nero	black
rame	copper
ottone	brass
grigio selce	flint grey
silver dark	dark silver

08800251
08800100
08800261
08800264
08800262
08800263

Schema foratura per fissaggio
 Drilling diagram for fixing

MOD. ONG

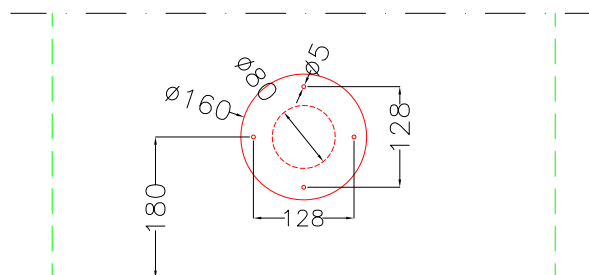

ELEMENTI DI FISSAGGIO

MOUNTING HARDWARE



Piastra per fissaggio a parete
Wall mounting plate

CODICE / CODE No.

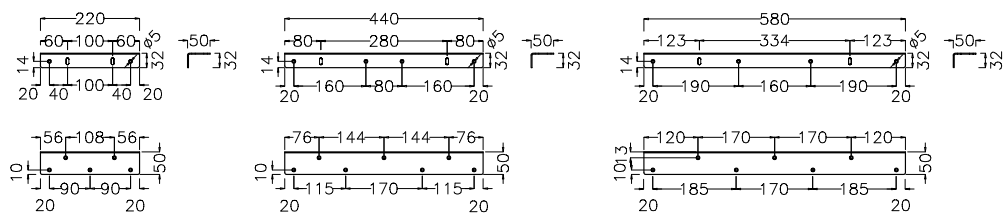
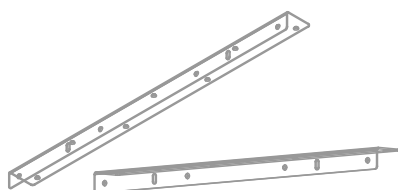

L 22 W 22
L 44 W 44
L 58 W 58

099108
099109
099110

FINITURE PER SOSTEGNO “CROSS” E “LOOM”

FINISHES FOR “CROSS” AND “LOOM” SUPPORTS

COLORI A POLVERE DUST COLOURS



nero (opz.7892) black
 grigio selce (opz.SEL) flint grey
 silver dark (opz.9507) dark silver

COLORI FREDDI OPACHI SOFT SOFT MATT COLD COLOURS



bianco assoluto (opz.740S) absolute white
 cenere (opz.9547) ash
 argilla (opz.9503) clay
 grigio bromo (opz.9533) bromine grey
 nero seppia (opz.7897) cuttlefish ink

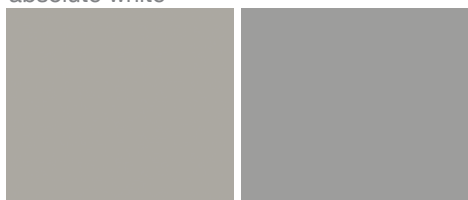

nebbia (opz.95F5) fog
 grigio traffico (opz.9511) traffic grey

COLORI CALDI OPACHI SOFT SOFT MATT HOT COLOURS



bianco caldo (opz.7401) warm white
 grigio kenya (opz.9501) kenya grey
 bistro (opz.9535) bistro
 blu cristal (opz.8381) crystal blue
 cannella (opz.8893) cinnamon
 fumo (opz.9531) smoke

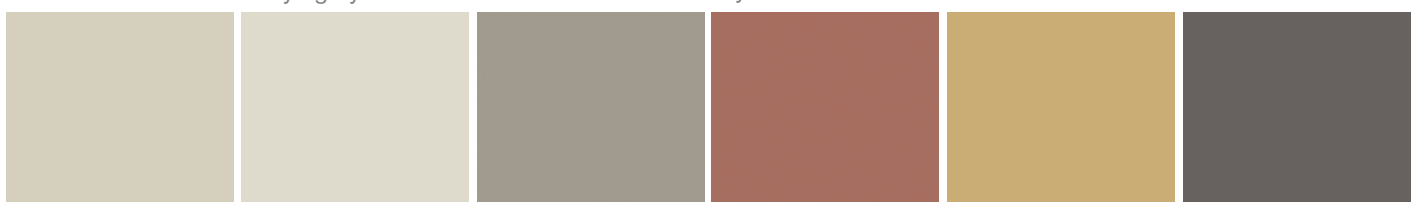

conchiglia (opz.7403) seashell
 lino (opz.9513) linen
 creta (opz.9515) clay
 rosso persia (opz.8165) persia red
 giallo zafferano (opz.8253) saffron yellow
 grigio piombo (opz.9537) lead grey

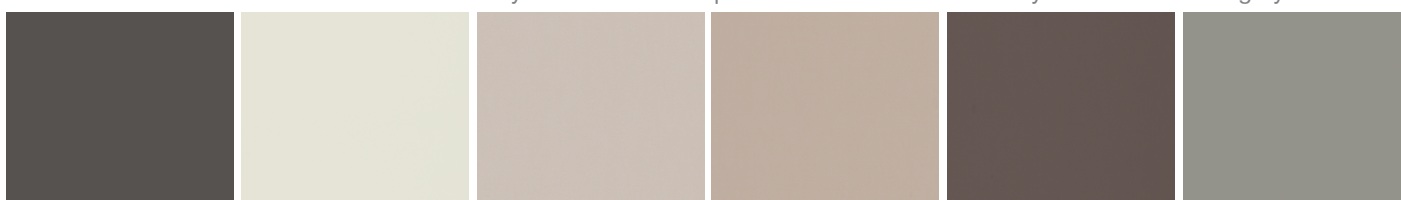

grigio lava (opz.95F1) lava grey
 polvere (opz.9539) dust
 platino (opz.7773) platinum
 nocciola (opz.7775) walnut
 cuoio (opz.8897) leather
 grigio reale (opz.95F3) royal grey

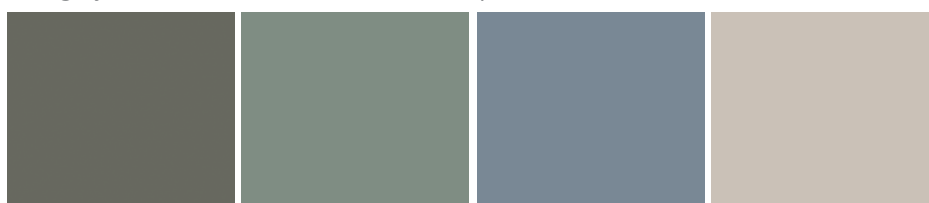

grigio quarzo (opz.95F7) quartz grey
 verde bosco (opz.8468) forest green
 azzurro nube (opz.8379) cloud blue
 tortora (opz.8993) dove grey

FINITURE PER SOSTEGNI

SUPPORTS FINISHES



titanio ossidato (opz.414)
titanium oxidized

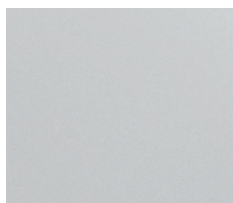

verniciato alluminio
painted aluminium



alluminio brill lucido
glossy brill aluminium

COLORI A POLVERE DUST COLOURS



nero (opz.7892)
black



grigio selce (opz.SEL)
flint grey



silver dark (opz.9507)
dark silver

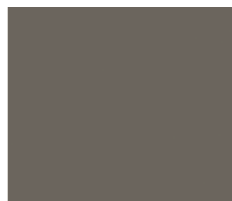

titanio (opz.414V)
titanium

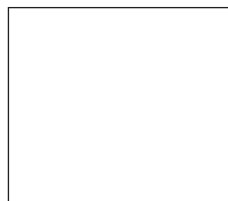

bianco assoluto
(opz.740S)
absolute white

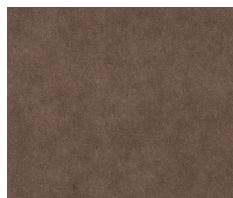

bronzo titanio
(opz.9552T)
titanium bronze

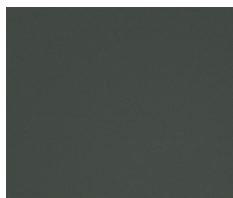

orione (opz.7022)
orion



rame (opz.8167)
copper



ottone (opz.7761)
brass

GAMBONE "CIRCLE"

"CIRCLE" SUPPORT



Gambone "CIRCLE" con piantana in metallo laccato nero o colore in abbinamento alle ante. Colori vedi pag.35
 "CIRCLE" support with base available in black lacquered metal or colour matching the doors.
 See colours at page 35

CODICE / CODE No.

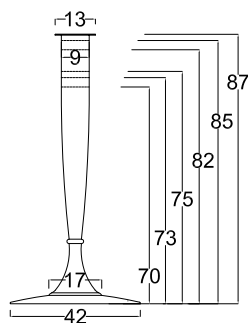

Piantana in abbinamento alle ante

- H 70
- H 73
- H 75
- H 82
- H 85
- H 87

Matching floor lamp with the doors

- H 70
- H 73
- H 75
- H 82
- H 85
- H 87

- 08800554**
- 08800552**
- 08800556**
- 08800557**
- 08800553**
- 08800559**

Piantana nera per le finiture noce

- H 70
- H 73
- H 75
- H 82
- H 85
- H 87

Black floor lamp for walnut finishes

- H 70
- H 73
- H 75
- H 82
- H 85
- H 87

- 08800544**
- 08800542**
- 08800546**
- 08800547**
- 08800543**
- 08800549**

Schema foratura per fissaggio
 Drilling diagram for fixing

MOD. CIRCLE

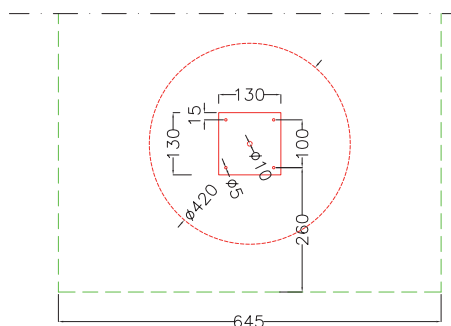

GAMBONE "BENS"

"BENS" SUPPORT



Gambone "BENS". Colori vedi pag.35
 "BENS" support. See colours at page 35

CODICE / CODE No.

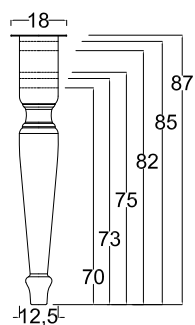

H 70	H 70
H 73	H 73
H 75	H 75
H 82	H 82
H 85	H 85
H 87	H 87

08800307
08800308
08800311
08800309
08800314
08800313

Schema foratura per fissaggio
 Drilling diagram for fixing

MOD. BENS

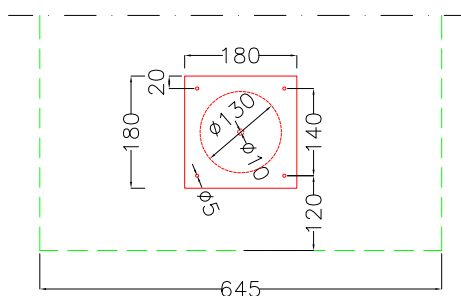

GAMBONE "REIL"

"REIL" SUPPORT



Gambone "REIL". Colori vedi pag.35
 "REIL" support. See colours at page 35

CODICE / CODE No.

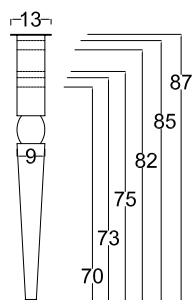

H 70	H 70
H 73	H 73
H 75	H 75
H 82	H 82
H 85	H 85
H 87	H 87

08800320
08800323
08800316
08800325
08800326
08800318

Schema foratura per fissaggio
 Drilling diagram for fixing

MOD. REIL

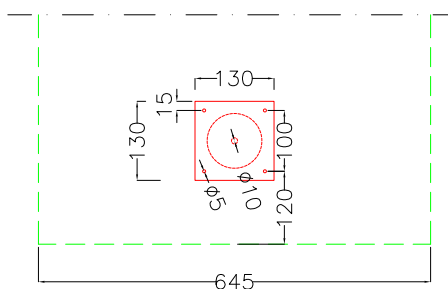

GAMBONE "KALIM"

"KALIM" SUPPORT



Gambone "KALIM". Colori vedi pag.35
 "KALIM" support. See colours at page 35

CODICE / CODE No.

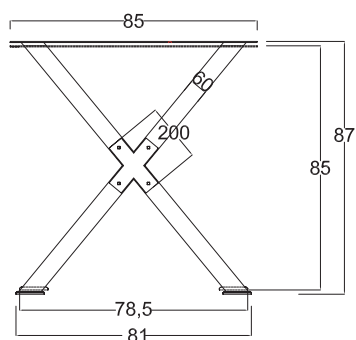

H 85
 H 87

H 85
 H 87

08800301
08800305

Schema foratura per fissaggio
 Drilling diagram for fixing

MOD. KALIM

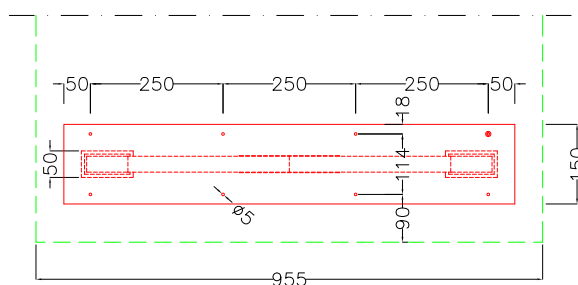

GAMBONE "CONTEMPO"

"CONTEMPO" SUPPORT



Gambone "CONTEMPO"
"CONTEMPO" support

CODICE / CODE No.

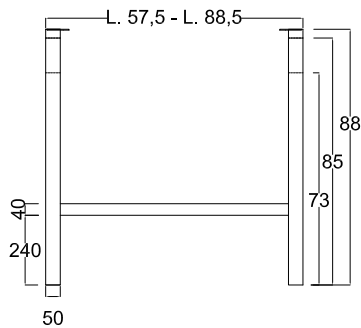

Colori
Colours

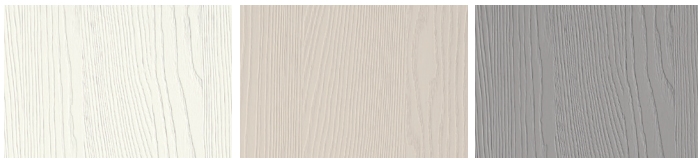

laccato bianco
(opz.2455)
white lacquered
(opt.2455)

laccato tortora
(opz.2456)
dove grey lacquered
(opt.2456)

laccato argilla
(opz.2457)
clay lacquered
(opt.2457)

H 73 L 57,5 H 73 W 57,5
H 85 L 57,5 H 85 W 57,5
H 88 L 57,5 H 88 W 57,5

H 73 L 88,5 H 73 W 88,5
H 85 L 88,5 H 85 W 88,5
H 88 L 88,5 H 88 W 88,5

08800332
08800336
08800340

08800334
08800338
08800342

Schema foratura per fissaggio
Drilling diagram for fixing

MOD. CONTEMPO DA 57.5

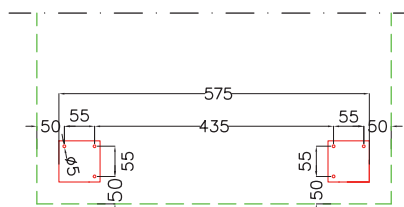

MOD. CONTEMPO DA 88.5

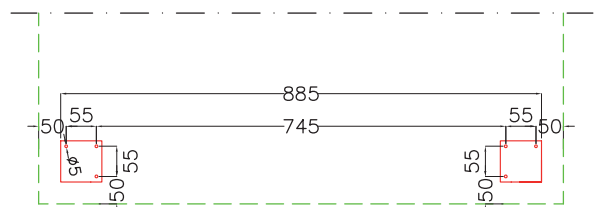

SOSTEGNO PENISOLA "ILAN" CON BARRA MULTIUSO ACCIAIO

"ILAN" PENINSULA SUPPORT WITH MULTIPORPOSE STEEL BAR



Sostegno penisola "ILAN" con barra multiuso in acciaio, laccato nei colori: bianco conchiglia (opt.W720), mandorla (opt.W820), lino (opt.W770), carbon (opt.W920), coloniale (opt.W870)
 "ILAN" peninsula support with multipurpose steel bar, available in the following lacquer colours: shell white (opt.W720), almond (opt.W820), linen (opt.W770), carbon (opt.W920), colonial (opt.W870)

CODICE / CODE No.

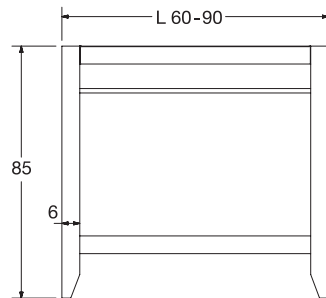

Colori laccati
Lacquered colours



carbon (opt.W920) carbon (opt.W920) mandorla (opt.W820) almond (opt.W820) lino (opt.W770) linen (opt.W770) bianco conchiglia (opt.W720) shell white (opt.W720)



coloniale (opt.W870) colonial (opt.W870)

L 60 W 60

0879094N

L 90 W 90

0879094P

Schema foratura per fissaggio
Drilling diagram for fixing

MOD. ILAN DA 60

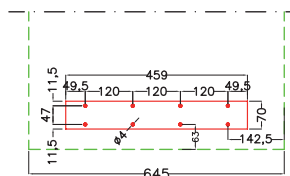

MOD. ILAN DA 90

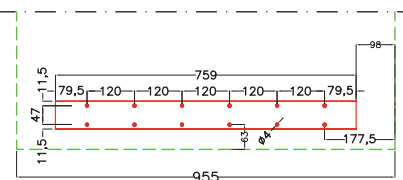

SOSTEGNO PENISOLA "MOST" LACCATO CON INSERTI IN FERRO GRAFITE

"MOST" LACQUERED PENINSULA SUPPORT WITH GRAPHITE IRON INSERTS



Sostegno penisola "MOST" laccato con inserti in ferro color grafite, regolabile in larghezza min.L 600 - max. L 900, laccato nei colori: bianco conchiglia (opz.W720), mandorla (opz.W820), lino (opz.W770), carbon (opz.W920), coloniale (opz.W870)
 "MOST" lacquered peninsula support with graphite iron insert, adjustable width (min.W 600-max.W900).
 Available in the following colours: shell white (opt.W720), almond (opt.W820), linen (opt.W770), carbon (opt.W920), colonial (opt.W870)

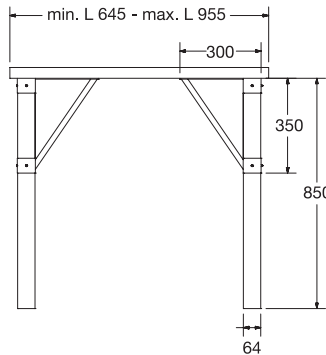

CODICE / CODE No.

Colori laccati
Lacquered colours



carbon (opz.W920) carbon (opt.W920)
 mandorla (opz.W820) almond (opt.W820)
 lino (opz.W770) linen (opt.W770)

bianco conchiglia (opz.W720) shell white (opt.W720)



coloniale (opz.W870) colonial (opt.W870)

min. L 600 - max. L 900
min.W 600 - max.W 900

0879094B

Schema foratura per fissaggio
Drilling diagram for fixing

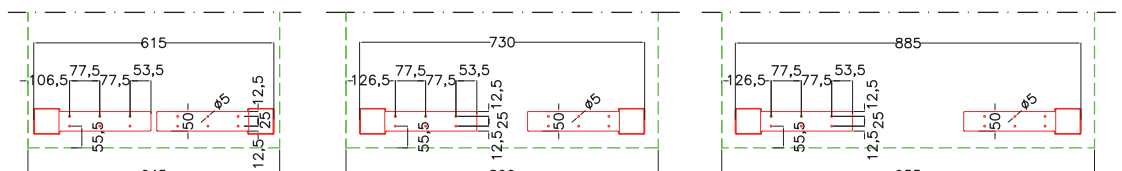

COLORI MODELLO AGNESE MODEL AGNESE COLOURS



bianco camelia
a poro aperto
(opz.606)
open pore camellia
white

argilla decapè
grigio a poro aperto
(opz.599)
open pore pickled
clay grey

grigio fumo
decapè bianco a poro
aperto (opz.603)
open pore pickled
white smoke grey

celeste decapè a poro
aperto (opz.607)
open pore pickled
sky blue

bianco assoluto
a poro aperto
(opz.609)
open pore absolute
white

COLORI MODELLO CLAUDIA MODEL CLAUDIA COLOURS

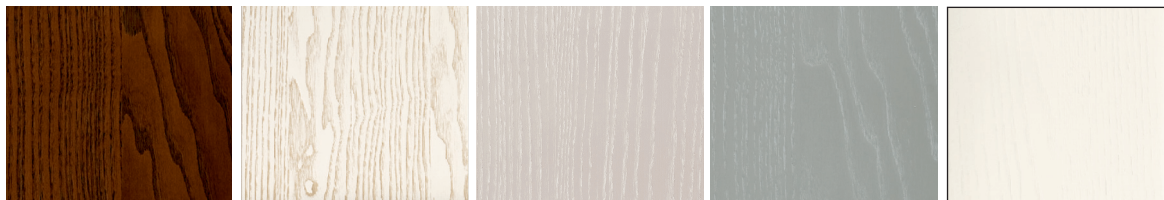

tinto noce spazzolato
(opz.561)
brushed
walnut-stained

panna decapè
spazzolato (opz.564)
brushed
pickled cream

corda decapè
spazzolato (opz.566)
brushed
pickled jute

argilla decapè
spazzolato (opz.567)
brushed
pickled clay

spazzolato laccato
bianco (opz.569)
brushed
white lacquered

COLORI MODELLO LAURA MODEL LAURA COLOURS



tinto noce
(opz.616)
walnut-stained

avorio decapè
(opz.617)
pickled ivory

grigio fumo decapè
bianco (opz.621)
white pickled
smoke grey

bianco decapè
(opz.F614)
pickled white

bianco camelia
vintage (opz.619)
vintage camellia
white

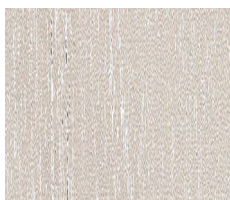

corda decapè
(opz.623)
pickled jute grey

COLORI MODELLO VERONICA MODEL VERONICA COLOURS

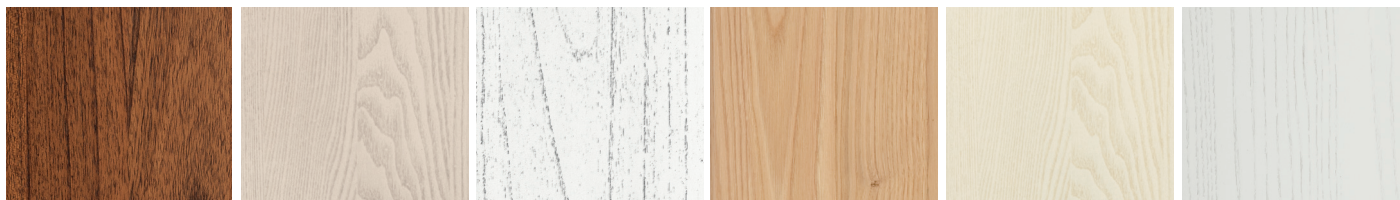

indica tinto noce
(opz.589)
walnut-stained
indica

argilla decapè grigio
(opz.587)
pickled clay grey

bianco assoluto
decapè grigio
(opz.588)
absolute white
pickled grey

castagno naturale
(opz.584)
natural chestnut

bianco decapè (opz.583)
pickled white

grigio luce (opz.593)
light grey



bianco artico (opz.590)
arctic white

cammello (opz.592)
camel

grigio fumo (opz.594)
smoke grey

sahara (opz.591)
sahara

piombo (opz.598)
lead

grigio reale (opz.595)
royal grey



LUBE INDUSTRIES SRL

Via dell'Industria, 4 - 62010 Treia (MC) Italia
Tel. centralino 0733 8401 (r.a.)
Fax 0733 840222 - 0733 840333
info@cucinelube.it - www.cucinelube.it
info@creokitchens.it - www.creokitchens.it

Lube Industries srl è dotata di Sistemi di Gestione per l'Efficienza Ambientale, per la Qualità e per la Salute e la Sicurezza sul Lavoro, in conformità alle norme: UNI EN ISO 14001, UNI EN ISO 9001 e UNI EN ISO 45001. Per maggiori informazioni visita il nostro sito www.cucinelube.it