

clover



CLOVER | MODERNO







clover

NATURALMENTE AUTENTICA
NATURALLY AUTHENTIC

LA CUCINA È L'AMBIENTE CHE DA SEMPRE STA AL CENTRO DELLA CASA E CHE È DESTINATA A DURARE NEL TEMPO E AD ACCOGLIERE LA PARTE PIÙ VERA ED EMOZIONALE DELLA NOSTRA VITA DOMESTICA.

CLOVER È STATA CREATA PER DURARE NEL TEMPO, GRAZIE AI MATERIALI CON I QUALI POTRETE VESTIRLA. LA NATURALE BELLEZZA DELLE ESSENZE MATERICHE, I LEGNI, ABBINATI AI COLORI ED AI MATERIALI CHE PIÙ RACCONTANO IL MONDO DELLA NATURA. CLOVER È FATTA DI QUESTO. AUTENTICA E NATURALE DECLINABILE IN MILLE FORME, DALLA PIÙ RAZIONALE, SQUADRATA ED ESSENZIALE, ALLA PIÙ SINUOSA, STONDATA ED ECLETTICA, È UNA CUCINA CHE SAPRÀ RISPONDERE ALLE PIÙ DIVERSE ESIGENZE ARREDATIVE.

THE KITCHEN IS A SPACE THAT HAS ALWAYS BEEN THE HEART OF ANY HOME. IT SHOULD BE BUILT TO LAST AND IS THE SETTING FOR THE MOST AUTHENTIC AND EMOTIONAL PARTS OF OUR DOMESTIC LIVES.

CLOVER IS DESIGNED TO LAST, THANKS TO THE MATERIALS YOU CAN USE TO CLOTHE IT. THE NATURAL BEAUTY OF TACTILE WOOD FINISHES IS COMBINED WITH COLOURS AND MATERIALS THAT EVOKE THE WORLD OF NATURE. THIS IS CLOVER. AUTHENTIC, NATURAL AND AVAILABLE IN A THOUSAND DIFFERENT SHAPES, FROM THE MOST RATIONAL, SQUARE AND MINIMALIST, TO THE MOST SINUOUS, ROUNDED AND ECLECTIC. THIS IS A KITCHEN THAT CAN ADAPT TO THE MOST DIVERSE FURNISHING REQUIREMENTS.

INDEX

DA PAG. 04

Lux

ANTA CON PROFILO PER APERTURE CON GOLA
DOOR WITH PROFILE FOR OPENINGS WITH FINGER RAIL

DA PAG. 56

Neck

ANTA SENZA PROFILO PER APERTURA CON GOLA
DOOR WITHOUT PROFILE FOR FINGER RAIL OPENING

DA PAG.116

Bridge

ANTA SQUADRATA CON MANIGLIA
SQUARE DOOR WITH HANDLE

DA PAG.242

INFORMAZIONI TECNICHE & FINITURE

TECHNICAL INFORMATION &
FINISHES



LUX

ANTA CON PROFILO PER APERTURE CON GOLA
DOOR WITH PROFILE FOR OPENINGS WITH FINGER RAIL

LA TIPOLOGIA LUX OFFRE ANTE ARRICCHITE DA UN PROFILO
IN METALLO, CURVO OPPURE AD "ELLE", CHE HA LA CARATTERISTICA
DI PRESERVARE IL BORDO DELL'ANTA STESSA.

ALLE ANTE BORDATE SONO POI ABBINATE DUE DIVERSE TIPOLOGIE
DI GOLA, DA POTER SCEGLIERE PER PERSONALIZZARE UNA CUCINA
PENSATA PER DURARE NEL TEMPO.

THE LUX RANGE OFFERS DOORS EMBELLISHED WITH METAL EDGES THAT ARE EITHER
CURVED OR "L" TYPE. THESE PROTECT THE EDGES OF THE DOOR ITSELF. THESE EDGED
DOORS ARE COMBINED WITH TWO DIFFERENT TYPES OF FINGER RAIL TO ALLOW YOU
ADD A PERSONAL TOUCH TO A KITCHEN THAT IS DESIGNED TO LAST.





Lux 01

IMPIALLACCIATO PORO SEMIAPERTO SENZA NODO ROVERE TERMOCOTTO FIAMMA VERTICALE
GRES LAMINAM TERRA FINITURA FOKOS TELAIO ALLUMINIO LACCATO OPACO CASTORO
TELAIO ALLUMINIO TITANIO CON VETRO BRONZO

SEMI-OPEN PORE VENEERED THERMO-TREATED OAK VERTICAL GRAIN WITHOUT KNOTS
FOKOS FINISH EARTH GRES LAMINAM, BEAVER MATT LACQUERED ALUMINIUM FRAME
TITANIUM ALUMINIUM FRAME WITH BRONZE GLASS





UNA COMPOSIZIONE ELEGANTE CHE PUÒ AVERE MOLTEPLICI INTERPRETAZIONI, GRAZIE AL CONTENIMENTO CHE OFFRE ED AI GIOCHI DI RIFLESSI E TRASPARENZE DELLE ANTE IN VETRO BRONZATO. LE MENSOLE CON LUCI INSERITE ILLUMINANO IL ROVERE TERMOCOTTO CREANDO UN'ATMOSFERA CALDA ED AVVOLGENTE.

AN ELEGANT COMPOSITION WITH MANY POSSIBLE INTERPRETATIONS THANKS TO THE STORAGE SPACE IT OFFERS AS WELL AS THE PLAY OF REFLECTION AND TRANSPARENCY OF THE BRONZED GLASS DOORS. THE SHELVES WITH BUILT-IN LIGHTS ILLUMINATE THE HEAT-TREATED OAK TO CREATE A WARM AND WELCOMING ENVIRONMENT.







OPZ. CG71C

GRES LAMINAM TERRA FINITURA FOKOS
TELAIO ALLUMINIO LACCATO OPACO CASTORO
FOKOS FINISH EARTH GRES LAMINAM,
BEAVER MATT LACQUERED ALUMINIUM FRAME



OPZ. 5410

IMPIALLACCIATO PORO SEMIAPERTO SENZA NODO ROVERE TERMOCOTTO FIAMMA VERTICALE
SEMI-OPEN PORE VENEERED THERMO-TREATED OAK VERTICAL GRAIN WITHOUT KNOTS

OPZ. 414

ZOCCOLO E GOLA / PLINTH AND FINGER RAIL
ALLUMINIO FINITURA TITANIO OSSIDATO
ALUMINIUM TITANIUM OXIDIZED FINISH



OPZ. TCBRZ

TELAIO ALLUMINIO TITANIO CON VETRO BRONZO
TITANIUM ALUMINIUM FRAME WITH BRONZE GLASS



LUX 02

ANTA "DUNE" LACCATA OPACA ARGILLA
 LACCATO OPACO CENERE
 LACCATO OPACO GRIGIO PIOMBO
 LACCATO OPACO FUMO

"DUNE" MATT LACQUERED CLAY DOOR
 ASH MATT LACQUERED
 LEAD GREY MATT LACQUERED
 SMOKE MATT LACQUERED



UN AMBIENTE RESO UNICO DALLA PRESENZA SCENICA DELLA NUOVA ANTA DUNE, IL CUI DISEGNO CORRE OMOGENEO SU TUTTA LA LUNGHEZZA DEI MODULI, SENZA SOLUZIONE DI CONTINUITÀ. I MODULI DELLA LIBRERIA CREANO UN PONTE CHE UNISCE L'AREA CUCINA A QUELLA LIVING.

AN ENVIRONMENT MADE UNIQUE BY THE SCENIC PRESENCE OF THE NEW DUNE DOOR. THE DESIGN OF THIS DOOR RUNS EVENLY THROUGH THE ENTIRE LENGTH OF THE MODULES WITHOUT ANY CONTINUITY SOLUTIONS. BOOKSHELF MODULES CREATE A BRIDGE THAT UNITES THE KITCHEN AND LIVING ROOM AREAS.







OPZ. 9503

ANTA "DUNE" LACCATA OPACA ARGILLA
"DUNE" MATT LACQUERED CLAY DOOR

OPZ. 9537

LACCATO OPACO GRIGIO PIOMBO
LEAD GREY MATT LACQUERED

OPZ. LM12

TOP / WORKTOP
LAMINATO OLD GREY FINITURA URBAN
OLD GREY LAMINATE WITH URBAN FINISH

OPZ. 9547

LACCATO OPACO CENERE
ASH MATT LACQUERED

OPZ. 9531

LACCATO OPACO FUMO
SMOKE MATT LACQUERED

OPZ.9531

GOLA E ZOCCOLO / FINGER RAIL AND PLINTH
FUMO
SMOKE



Lux 03

IMPIALLACCIATO SPAZZOLATO MATERICO CON NODO ROVERE TABACCO FIAMMA VERTICALE
GRES LAMINAM SALE FINITURA FOKOS TELAIO ALLUMINIO LACCATO OPACO FUMO

BRUSHED VENEERED TOBACCO OAK WITH VERTICAL GRAIN AND KNOTS, TEXTURED FINISH
FOKOS FINISH SALE GRES LAMINAM, SMOKE MATT LACQUERED ALUMINIUM FRAME







LA PENISOLA SI CARATTERIZZA PER LA PRESENZA DEI FUOCHI PIT-COOKING E PER LA VASCA DEL LAVELLO RICAVATA DIRETTAMENTE NEL PIANO DI LAVORO. QUESTA SOLUZIONE OFFRE, OLTRE AD UN'ESTETICA ACCATTIVANTE, UN'ESTREMA SEMPLICITÀ NELLE OPERAZIONI DI PULIZIA NECESSARIE IN CUCINA.

THIS PENINSULA UNIT IS CHARACTERISED BY THE PRESENCE OF PIT-COOKING BURNERS AND A SINK BUILT DIRECTLY INTO THE WORKTOP. THIS SOLUTION OFFERS EXTREMELY EASY CLEANING AS WELL AS A CAPTIVATING DESIGN.





UN LIVING SEMPLICE, CHE RIPRENDE I TONI DELLA CUCINA E SI CARATTERIZZA PER LA PRESENZA DEL PANNELLO A PARETE, A CUI È AFFIDATA LA DOPPIA FUNZIONE DI PORTA OGGETTI ED ELEMENTO DECORATIVO.

A SIMPLE LIVING ROOM THAT REPEATS THE COLOURS OF THE KITCHEN AND IS CHARACTERISED BY THE PRESENCE OF A WALL PANEL. THIS WALL PANEL FUNCTIONS BOTH AS A DECORATIVE FEATURE AND STORAGE SHELVING.

OPZ. LG70F

GRES LAMINAM SALE FINITURA FOKOS TELAIO ALLUMINIO LACCATO OPACO FUMO
FOKOS FINISH SALE GRES LAMINAM, SMOKE MATT LACQUERED ALUMINIUM FRAME

OPZ. 414

GOLA E ZOCCOLO / FINGER RAIL AND PLINTH
ALLUMINIO FINITURA TITANIO OSSIDATO
ALUMINIUM TITANIUM OXIDIZED FINISH

OPZ. 5405

IMPIALLACCIATO SPAZZOLATO MATERICO CON NODO ROVERE TABACCO FIAMMA VERTICALE
BRUSHED VENEERED TOBACCO OAK WITH VERTICAL GRAIN AND KNOTS, TEXTURED FINISH

OPZ. 1452

TOP / WORKTOP

STRATIFICATO "HPL" BORDO FOLDING, RESINA FINITURA CLIMB
LAYERED "HPL" FOLDING EDGE, RESIN WITH CLIMB FINISH



Lux 04

IMPIALLACCIATO SPAZZOLATO MATERICO CON NODO ROVERE GRAFITE FIAMMA VERTICALE
LACCATO OPACO FINITURA MALTA CON FONDO CEMENTO LIGHT GREY

BRUSHED VENEERED GRAPHITE OAK WITH VERTICAL GRAIN AND KNOTS, TEXTURED FINISH
MATT LACQUERED MORTAR FINISH WITH LIGHT GREY CEMENT SURFACE







IL CONTRASTO TRA IL ROVERE GRAFITE E LA MALTA LIGHT GREY È IL PROTAGONISTA DELLA COMPOSIZIONE QUI PRESENTATA. IL CARATTERE DECISO DELLE FINITURE ED IL LORO PONDERATO ACCOSTAMENTO CONFERISCONO PERSONALITÀ A TUTTI GLI ELEMENTI PRESENTI.

THE CONTRAST BETWEEN GRAPHITE OAK AND LIGHT GREY MORTAR IS THE STAR OF THIS COMPOSITION. THE STRONG CHARACTER OF THE FINISHES AND THEIR CAREFULLY CONSIDERED PLACEMENT GIVE CHARACTER TO EACH ELEMENT.







OPZ. 5403

IMPIALLACCIATO SPAZZOLATO MATERICO CON NODO
ROVERE GRAFITE FIAMMA VERTICALE
BRUSHED VENEERED GRAPHITE OAK WITH VERTICAL GRAIN AND KNOTS,
TEXTURED FINISH

GOLA E ZOCCOLO / FINGER RAIL AND PLINTH
GRIGIO BROMO OPZ. 9533 / CENERE OPZ. 9547
BROMINE GREY / ASH



OPZ. LM14

LACCATO OPACO FINITURA MALTA CON FONDO CEMENTO LIGHT GREY
MATT LACQUERED MORTAR FINISH WITH LIGHT GREY CEMENT SURFACE

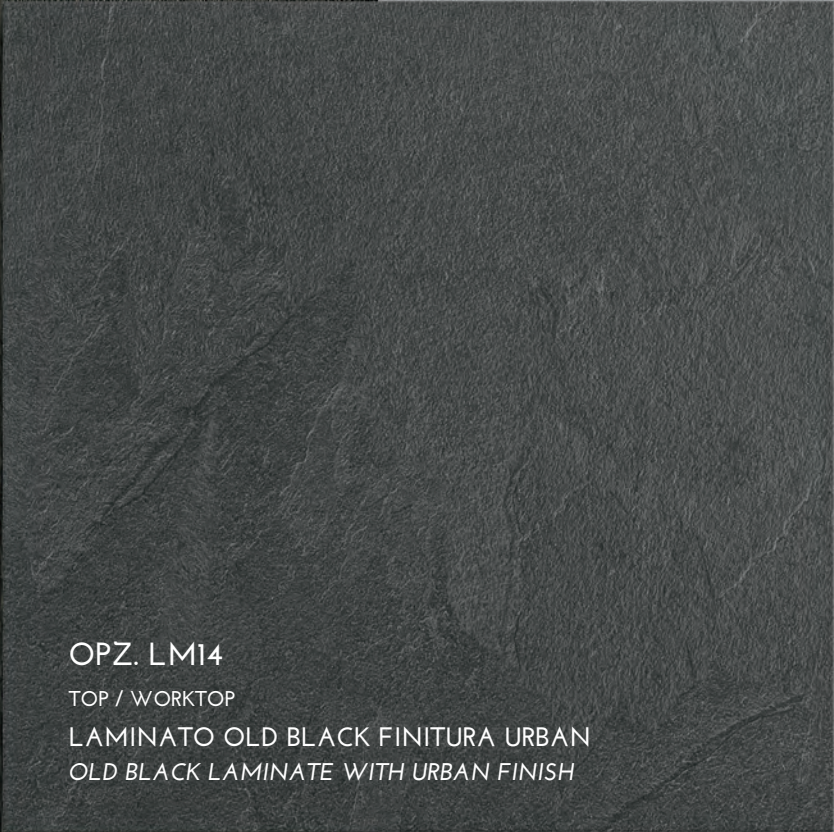

OPZ. LM14

TOP / WORKTOP
LAMINATO OLD BLACK FINITURA URBAN
OLD BLACK LAMINATE WITH URBAN FINISH

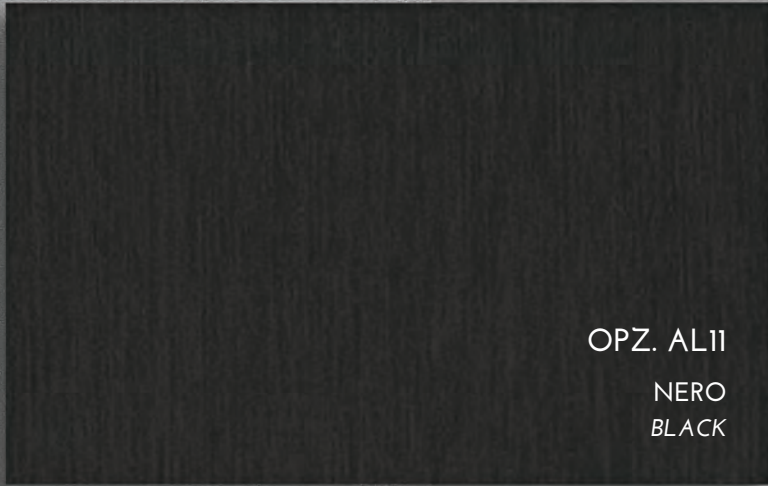

OPZ. AL11
NERO
BLACK



Neck

ANTA SENZA PROFILO PER APERTURA CON GOLA
DOOR WITHOUT PROFILE FOR FINGER RAIL OPENING

UN'APERTURA LINEARE, UNICA, SENZA PROFILI
SAGOMATI, PER CHI AMA LA SEMPLICITÀ,
CONSIDERANDOLA FONDAMENTO DI UNO STILE
SOBRIO ED ELEGANTE.

*A UNIQUE LINEAR OPENING, WITHOUT SHAPED PROFILES,
FOR THOSE THAT LOVE SIMPLICITY AS THE FOUNDATION
FOR A SOBER AND ELEGANT DESIGN.*





Neck 05

LACCATO OPACO GRIGIO KENIA
LACCATO OPACO FUMO

KENYA GREY MATT LACQUERED
SMOKE MATT LACQUERED



IL PIANO DI LAVORO IN ACCIAIO DIALOGA PERFETTAMENTE CON LA CAPPA SOSPESA, SIA NELLA FORMA CHE NEL MATERIALE. IL MOTIVO STONDATA DEGLI ANGOLARI RICORRE IN TUTTA LA COMPOSIZIONE, DANDO MORBIDEZZA ALL'INTERO AMBIENTE.

NEL BLOCCO COLONNE DUE FORNI E CAPACI RIPIANI SONO NASCOSTI DALL'ANTA SCORREVOLE.

THE STEEL WORKTOP DIALOGUES PERFECTLY WITH THE SUSPENDED EXTRACTION HOOD, BOTH IN TERMS OF FORM AND MATERIAL. THE ROUNDED MOTIF OF THE CORNER UNITS RUNS THROUGH THE ENTIRE COMPOSITION, BRINGING A SOFT FEEL TO THE ENTIRE SPACE. THE COLUMN UNIT CONTAINS TWO OVENS AND SPACIOUS SHELVES ARE CONCEALED BEHIND THE SLIDING DOOR.





OPZ. 9531

LACCATO OPACO FUMO
SMOKE MATT LACQUERED

OPZ. 9501

LACCATO OPACO GRIGIO KENIA
KENYA GREY MATT LACQUERED

OPZ. 5401

PIANO SNACK / SNACK BAR
IMPIALLACCIATO SPAZZOLATO MATERICO CON NODO GRIGIO NEBBIA
BRUSHED VENEERED MIST GREY OAK WITH KNOTS, TEXTURED FINISH

TOP / WORKTOP
ACCIAIO INOX
STAINLESS STEEL

OPZ. 9531

GOLA E ZOCCOLO / FINGER RAIL AND PLINTH
FUMO
SMOKE



Neck 06

VETRO LUCIDO BIANCO CALDO TELAIO ALLUMINIO OPACO IN TINTA
VETRO LUCIDO VERDE POSITANO TELAIO ALLUMINIO OPACO IN TINTA

WARM WHITE GLOSSY GLASS WITH MATCHING ALUMINIUM FRAME MATT FINISH
POSITANO GREEN GLOSSY GLASS WITH MATCHING ALUMINIUM FRAME MATT FINISH





UNA COMPOSIZIONE CARATTERIZZATA DA UN EQUILIBRATO MIX DI PIENI E VUOTI, GRAZIE ALLA PRESENZA DEI PANNELLI CON MENSOLE E SOSTEGNI IN TITANIO CHE CONTRASTANO CON LA LINEARITÀ DELLE ANTE IN VETRO.

A COMPOSITION CHARACTERISED BY A BALANCED BLEND OF PRESENCE AND ABSENCE CREATED BY PANELS WITH SHELVES AND TITANIUM SUPPORTS THAT CONTRAST WITH THE LINEARITY OF THE GLASS DOORS.





VARIANTE CROMATICA CON VETRO FUMO LUCIDO / COLOUR VARIANT WITH SMOKE GLOSSY GLASS

OPZ. 0032

TOP / WORKTOP
FENIX BIANCO CALDO
PROFILO "PP"
WARM WHITE FENIX
WITH "PP" PROFILE

OPZ. V8472

VETRO LUCIDO VERDE POSITANO
TELAIO ALLUMINIO OPACO IN TINTA
POSITANO GREEN GLOSSY GLASS WITH
MATCHING ALUMINIUM FRAME MATT FINISH

OPZ. 7401

FIANCHI DI FINITURA / STRUCTURAL SIDES SAME FINISH AS DOOR
LACCATO OPACO BIANCO CALDO
WARM WHITE MATT LACQUERED

OPZ. V7402

VETRO LUCIDO BIANCO CALDO TELAIIO ALLUMINIO OPACO IN TINTA
WARM WHITE GLOSSY GLASS WITH MATCHING ALUMINIUM FRAME MATT FINISH

OPZ. 0718

TOP / WORKTOP
FENIX FUMO PROFILO "PP"
SMOKE FENIX WITH "PP" PROFILE

OPZ. 9531

GOLA E ZOCCOLO / FINGER RAIL AND PLINTH
FUMO
SMOKE



Neck 07

LACCATO OPACO GRIGIO BROMO
LACCATO LUCIDO BIANCO ASSOLUTO
LACCATO BIANCO ASSOLUTO CON DECORO ASTRATTO A RILIEVO CENERE

*BROMINE GREY MATT LACQUERED
ABSOLUTE WHITE GLOSSY LACQUERED
ABSOLUTE WHITE LACQUERED WITH ASH ABSTRACT DECORATION IN RELIEF*





LA CUCINA È CARATTERIZZATA DAI TERMINALI STONDATI DELLE BASI E DEI PENSILI CHE, UNITI ALLA PENISOLA DALLA FORMA UNICA, TRASMETTONO UN SENSO DI AVVOLGENZA E MORBIDEZZA CHE DOMINA L'INTERA COMPOSIZIONE. I TONI LACCATI OPACHI E LUCIDI CREANO UN CONTRASTO SOBRIO MA NON BANALE.

THIS KITCHEN IS CHARACTERISED BY ROUNDED END UNITS FOR THE BASE AND WALL UNITS. TOGETHER WITH THE UNIQUE SHELF, THESE PROVIDE A SOFT AND WELCOMING FEEL THAT DOMINATES THE ENTIRE COMPOSITION. THE MATT AND GLOSSY LACQUER COLOURS CREATE A SOBER AND UNUSUAL CONTRAST







OPZ. 740SD

LACCATO BIANCO ASSOLUTO CON
DECORO ASTRATTO A RILIEVO CENERE
ABSOLUTE WHITE LACQUERED WITH
ASH ABSTRACT DECORATION IN RELIEF

*materiale non disponibile

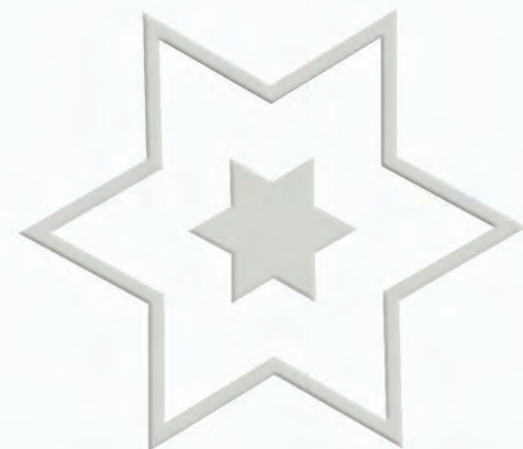

OPZ. 741

LACCATO LUCIDO BIANCO ASSOLUTO
ABSOLUTE WHITE GLOSSY LACQUERED

OPZ. 9533

GOLA E ZOCCOLO / FINGER RAIL AND PLINTH
GRIGIO BROMO
BROMINE GREY

OPZ. 301

TOP / WORKTOP
CORIAN GLACIER WHITE
GLACIER WHITE CORIAN

OPZ. 9533

LACCATO OPACO GRIGIO BROMO
BROMINE GREY MATT LACQUERED



Neck 08

IMPIALLACCIATO SPAZZOLATO MATERICO CON NODO ROVERE NATURALE FIAMMA VERTICALE
LACCATO OPACO FINITURA MALTA CON FONDO CEMENTO WHITE
LACCATO BIANCO CALDO CON DECORO ASTRATTO A RILIEVO CASTORO
*BRUSHED VENEERED NATURAL OAK WITH VERTICAL GRAIN AND KNOTS, TEXTURED FINISH
MATT LACQUERED MORTAR FINISH WITH WHITE CEMENT SURFACE
WARM WHITE LACQUERED WITH BEAVER ABSTRACT DECORATION IN RELIEF*





L'ANTA LACCATA CON DECORO ASTRATTO A RILIEVO, QUI PRESENTATA IN BIANCO CALDO CON DISEGNI IN CASTORO, ARRICCHISCE LA COMPOSIZIONE CUCINA DONANDOLE VALENZA ESTETICA E DECORATIVA.

THE LACQUERED DOOR WITH AN ABSTRACT DECORATION IN RELIEF IS SHOWN HERE IN WARM WHITE WITH DESIGNS IN BEAVER BROWN. THIS FEATURE ENHANCES THE COMPOSITION, GIVEN IT AN AESTHETIC AND DECORATIVE FEEL.





LE COLONNE CON ANTE RIENTRANTI SONO LA SOLUZIONE OTTIMALE PER FORNIRE SPAZIO DI CONTENIMENTO VISIBILE SOLO QUANDO SERVE. L'ASPETTO DELL'AMBIENTE RISULTA PULITO, ESSENZIALE E LIBERO DA OGNI INGOMBRO, MENTRE ALL'INTERNO DELLE COLONNE SI TROVANO SCOMPARTI, RIPIANI ESTRAIBILI, CASSETTI, FORNI E TUTTO QUELLO CHE PUÒ SERVIRE AD UN COMODO UTILIZZO DELLA CUCINA.

THESE COLUMNS WITH RECESSED DOORS ARE THE IDEAL SOLUTION FOR STORAGE SPACES THAT ONLY BECOME VISIBLE WHEN NEEDED. THE SPACE LOOKS CLEAN, MINIMALIST AND FREE OF ANY CLUTTER. THE INSIDES OF THE COLUMNS FEATURE COMPARTMENTS, REMOVABLE SHELVES, DRAWERS, AN OVEN AND EVERYTHING ELSE YOU NEED TO MAKE EASY USE OF THE KITCHEN.





OPZ. 0032
 TOP / WORKTOP
 FENIX BIANCO CALDO PROFILO "PP"
 WARM WHITE FENIX WITH "PP" PROFILE

OPZ. 5404
 IMPIALLACCIATO SPAZZOLATO MATERICO CON NODO
 ROVERE NATURALE FIAMMA VERTICALE
 BRUSHED VENEERED NATURAL OAK WITH VERTICAL GRAIN
 AND KNOTS, TEXTURED FINISH

OPZ. 7401D
 LACCATO BIANCO CALDO CON
 DECORO ASTRATTO A RILIEVO CASTORO
 WARM WHITE LACQUERED WITH
 BEAVER ABSTRACT DECORATION IN RELIEF
 *materiale non disponibile

OPZ. LM11
 LACCATO OPACO FINITURA MALTA CON FONDO CEMENTO WHITE
 MATT LACQUERED MORTAR FINISH WITH WHITE CEMENT SURFACE

OPZ. 414
 ZOCCOLO E GOLA / PLINTH AND FINGER RAIL
 ALLUMINIO FINITURA TITANIO OSSIDATO
 ALUMINIUM TITANIUM OXIDIZED FINISH



Neck 09

LACCATO FUMO OPACO E LUCIDO
LACCATO LUCIDO BIANCO ASSOLUTO

SMOKE MATT AND GLOSSY LACQUERED
ABSOLUTE WHITE GLOSSY LACQUERED







LE CUCINE CARATTERIZZATE DALLE BASI E DALLE COLONNE CON LA FORMA STONDATA SONO, PER LORO NATURA E DISEGNO, LE PIU' ADATTE AD ESSERE INSERITE IN SPAZI APERTI, SENZA UN VERO E PROPRIO CONFINE DI PASSAGGIO CON IL LIVING O LA ZONA PRANZO. QUESTA COMPOSIZIONE RAPPRESENTA L'ESSENZA DELLA CUCINA STONDATA, IN UN GIUSTO EQUILIBRIO FRA FORMA, STILE E FUNZIONE, IN UN AVVOLGENTE ED ERGONOMICO ABBRACCIO.

BY THEIR NATURE AND DESIGN, KITCHENS CHARACTERISED BY ROUNDED BASE UNITS AND COLUMN UNITS ARE THE MOST SUITABLE FOR OPEN SPACES WITHOUT CLEAR BOUNDARIES BETWEEN THE LIVING OR DINING AREA. THIS COMPOSITION REPRESENTS THE ESSENCE OF A ROUNDED KITCHEN, STRIKING THE RIGHT BALANCE BETWEEN FORM, STYLE AND FUNCTION TO CREATE A WARM AND ERGONOMIC EMBRACE.



LA LIBRERIA, NELLE STESS E FINITURE DELLA CUCINA, CONTIENE LA ZONA TV, PENSILI E TANTO SPAZIO PER I LIBRI E GLI OGGETTI.

THE BOOKCASE, AVAILABLE IN THE SAME FINISHES AS THE KITCHEN, CONTAINS THE TV AREA, SHELVES AND SPACE FOR BOOKS AND ORNAMENTS.

OPZ. 0718
TOP / WORKTOP
FENIX FUMO PROFILO "PP"
SMOKE FENIX WITH "PP" PROFILE

OPZ. 741
LACCATO LUCIDO BIANCO ASSOLUTO
ABSOLUTE WHITE GLOSSY LACQUERED

OPZ. 412
GOLA E ZOCCOLO / FINGER RAIL AND PLINTH
ALLUMINIO FINITURA BRILL
ALUMINIUM BRILL FINISH

OPZ. 9531 - OPZ. 9532
LACCATO FUMO OPACO E LUCIDO
SMOKE MATT AND GLOSSY LACQUERED



Bridge

ANTA SQUADRATA CON MANIGLIA
SQUARE DOOR WITH HANDLE

MANIGLIA FRONTALE, APPLICATA IN TESTA O AD INCASSO, OPPURE TECNOLOGIA PUSH/PULL PER GLI AMANTI DELLO STILE MINIMAL. LA TIPOLOGIA DI APERTURA BRIDGE, CON LE SUE VARIANTI ESTETICHE E FUNZIONALI, SAPRÀ FORNIRE LA GIUSTA SOLUZIONE AD OGNI ESIGENZA.

FRONT HANDLE, APPLIED AT THE END OR RECESSED, OR WITH PUSH-PULL TECHNOLOGY FOR THOSE THAT LOVE THE MINIMALIST LOOK. THE BRIDGE OPENING WITH ITS AESTHETIC AND FUNCTIONAL VARIANTS IS ABLE TO OFFER THE RIGHT SOLUTION FOR ANY REQUIREMENT.





Bridge 10

IMPIALLACCIATO SPAZZOLATO MATERICO CON NODO ROVERE TABACCO FIAMMA VERTICALE
LACCATO OPACO FINITURA MALTA CON FONDO CEMENTO WHITE
TELAIO ALLUMINIO TITANIO CON VETRO BRONZO

*BRUSHED VENEERED TOBACCO OAK WITH VERTICAL GRAIN AND KNOTS, TEXTURED FINISH
MATT LACQUERED MORTAR FINISH WITH WHITE CEMENT SURFACE
TITANIUM ALUMINIUM FRAME WITH BRONZE GLASS*







LE MENSOLE ED I PENSILI CON ANTE A VETRO SONO DOTATI DI LUCE INTERNA A LED, CHE AMPLIFICANO I TONI CALDI DEL ROVERE TABACCO, E ACCENDONO LA COMPOSIZIONE DI RIFLESSI E GIOCHI DI LUCE.

THE GLASS SHELVES AND WALL UNITS ARE FITTED WITH INTERNAL LED LIGHTS. THESE AMPLIFY THE WARM COLOURS OF THE TOBACCO OAK AND LIGHT UP THE COMPOSITION WITH REFLECTIONS AND PLAYS OF LIGHT.





OPZ. 5405
IMPIALLACCIATO SPAZZOLATO MATERICO CON NODO ROVERE TABACCO FIAMMA VERTICALE
BRUSHED VENEERED TOBACCO OAK WITH VERTICAL GRAIN AND KNOTS, TEXTURED FINISH

OPZ. TCBRZ
TELAIO ALLUMINIO TITANIO CON VETRO BRONZO
TITANIUM ALUMINIUM FRAME WITH BRONZE GLASS

OPZ. LM13
TOP / WORKTOP
LAMINATO OLD DARK FINITURA URBAN ABS 1
OLD DARK LAMINATE WITH URBAN FINISH ABS 1

OPZ. LM11
LACCATO OPACO FINITURA MALTA CON FONDO CEMENTO WHITE
MATT LACQUERED MORTAR FINISH WITH WHITE CEMENT SURFACE

OPZ. 414
ZOCOLO / PLINTH
ALLUMINIO FINITURA TITANIO OSSIDATO
ALUMINIUM TITANIUM OXIDIZED FINISH



Bridge 11

IMPIALLACCIATO SPAZZOLATO MATERICO CON NODO ROVERE POLVERE FIAMMA VERTICALE
LACCATO FUMO CON DECORO ASTRATTO A RILIEVO CANAPA
LACCATO OPACO FINITURA MALTA CON FONDO CEMENTO BLACKBOARD
BRUSHED VENEERED DUST OAK WITH VERTICAL GRAIN AND KNOTS, TEXTURED FINISH
SMOKE LACQUERED WITH HEMP ABSTRACT DECORATION IN RELIEF
MATT LACQUERED MORTAR FINISH WITH BLACKBOARD CEMENT SURFACE







L'ANTA LACCATA CON DECORO ASTRATTO IN RILIEVO, QUI PRESENTATA NELLA FINITURA FUMO CON DISEGNI CANAPA, DIVENTA ELEMENTO SCORREVOLE CHE FILTRA L'ACCESSO AI DUE FORNI AD INCASSO E AD UN'AREA ATTREZZATA DI RIPIANI E VANI DEDICATI AL CONTENIMENTO.

THE LACQUERED DOOR WITH AN ABSTRACT DECORATION IN RELIEF IS SHOWN HERE IN SMOKE FINISH WITH DESIGNS IN HEMP. IT FUNCTIONS AS A SLIDING ELEMENT THAT GIVES ACCESS TO THE TWO RECESS-FITTED OVENS AND ANOTHER EQUIPPED AREA AND STORAGE COMPARTMENTS.



LA ZONA LIVING È ARREDATA CON UNA COMPOSIZIONE CARATTERIZZATA DALL'UNIONE DI BASI SOPPESE, LIBRERIA E DAL NUOVO PANNELLO PORTA TV, IN GRADO DI NASCONDERE L'ATTREZZATURA TECNICA.

THE LIVING AREA IS FURNISHED WITH A COMPOSITION CHARACTERISED BY THE COMBINATION OF SUSPENDED BASE UNITS, A BOOKSHELF AND A NEW TV HOLDER PANEL THAT CONCEALS ALL THE TECHNICAL EQUIPMENT.





L'ELEGANTE MOBILE LIVING LINEA "PLAN" VALORIZZATO DA MATERIALI E DETTAGLI ESCLUSIVI, È VERSATILE ED ADATTABILE AD OGNI SPAZIO DELLA CASA, OLTRE AD OFFRIRE SPAZIO CONTENITIVO E DI APPOGGIO.

THE ELEGANT "PLAN" LIVING CABINET MAKES USE OF EXCLUSIVE MATERIALS AND DETAILS, IT'S VERSATILE AND CAN BE ADAPTED TO ANY SPACE IN THE HOME. IT ALSO PROVIDES STORAGE SPACE AND A USABLE TOP.



OPZ. 9531D

LACCATO FUMO CON
DECORO ASTRATTO A RILIEVO CANAPA
SMOKE LACQUERED WITH
HEMP ABSTRACT DECORATION IN RELIEF
**materiale non disponibile*



OPZ. 5402

IMPIALLACCIATO SPAZZOLATO MATERICO CON NODO
ROVERE POLVERE FIAMMA VERTICALE
BRUSHED VENEERED DUST OAK WITH VERTICAL GRAIN AND KNOTS, TEXTURED FINISH



OPZ. LM12

TOP / WORKTOP

LAMINATO OLD GREY FINITURA URBAN ABS 1
OLD GREY LAMINATE WITH URBAN FINISH ABS 1

OPZ. LM13

LACCATO OPACO FINITURA MALTA
CON FONDO CEMENTO BLACKBOARD
MATT LACQUERED MORTAR FINISH WITH
BLACKBOARD CEMENT SURFACE

OPZ. 9531

LACCATO OPACO FUMO
SMOKE MATT LACQUERED

OPZ. 414

ZOCCOLO / PLINTH
ALLUMINIO FINITURA TITANIO OSSIDATO
ALUMINIUM TITANIUM OXIDIZED FINISH



Bridge 12

IMPIALLACCIATO PORO SEMIAPERTO SENZA NODO ROVERE TERMOCOTTO FIAMMA VERTICALE
LACCATO OPACO FINITURA MALTA CON FONDO CEMENTO DARK GREY
TELAIO ALLUMINIO NERO CON VETRO SATINATO

SEMI-OPEN PORE VENEERED THERMO-TREATED OAK VERTICAL GRAIN WITHOUT KNOTS
MATT LACQUERED MORTAR FINISH WITH DARK GREY CEMENT SURFACE
BLACK ALUMINIUM FRAME WITH SATIN GLASS









LA ZONA PRANZO, SEPPUR SEPARATA DALLA CUCINA, È UNITA ALLA STESSA DALLO STILE E DAI MATERIALI DEGLI ARREDI PRESENTI. IL TONO CALDO DEL ROVERE TERMOCOTTO SI ACCENDE GRAZIE AGLI ELEMENTI LUMINOSI INTERNI, CREANDO UNA SOLUZIONE SUGGERITIVA E MOLTO ELEGANTE.

DESPITE BEING PHYSICALLY SEPARATE FROM THE KITCHEN, THE LUNCH AREA IS UNITED WITH IT STYLISTICALLY IN TERMS OF MATERIALS AND FURNISHINGS. THE WARM COLOURS OF THE HEAT-TREATED OAK ARE LIT UP BY INTERNAL LIGHTS, CREATING A SUGGESTIVE AND VERY ELEGANT SOLUTION.



OPZ. LM12

LACCATO OPACO FINITURA MALTA
CON FONDO CEMENTO DARK GREY
MATT LACQUERED MORTAR FINISH
WITH DARK GREY CEMENT SURFACE

OPZ. NCSAT

TELAIO ALLUMINIO NERO CON VETRO SATINATO
BLACK ALUMINIUM FRAME WITH SATIN GLASS

OPZ. 5410

IMPIALLACCIATO PORO SEMIAPERTO SENZA NODO
ROVERE TERMOCOTTO FIAMMA VERTICALE
SEMI-OPEN PORE VENEERED THERMO-TREATED OAK
VERTICAL GRAIN WITHOUT KNOTS

OPZ. NU

ZOCCOLO / PLINTH
ALLUMINIO FINITURA URBAN OSSIDATO
ALUMINIUM URBAN OXIDIZED FINISH

OPZ. LM13

TOP / WORKTOP

LAMINATO OLD DARK FINITURA URBAN ABS 1
OLD DARK LAMINATE WITH URBAN FINISH ABS 1



Bridge 13

IMPIALLACCIATO PORO SEMIAPERTO SENZA NODO NOCE CANALETTO FIAMMA VERTICALE
LACCATO CANAPA CON DECORO ASTRATTO A RILIEVO CASTORO
LACCATO OPACO FINITURA MALTA CON FONDO CEMENTO DARK GREY
TELAIO ALLUMINIO TITANIO CON VETRO BRONZO

SEMI-OPEN PORE VENEERED CANALETTO WALNUT VERTICAL GRAIN WITHOUT KNOTS
HEMP LACQUERED WITH BEAVER ABSTRACT DECORATION IN RELIEF
MATT LACQUERED MORTAR FINISH WITH DARK GREY CEMENT SURFACE
TITANIUM ALUMINIUM FRAME WITH BRONZE GLASS





L'ANTA A TUTTA ALTEZZA IN VETRO BRONZO E TELAIO TITANIO CELA UN VANO CHE PUÒ CONTENERE UTILI ELETTRODOMESTICI, O PIÙ SEMPLICEMENTE ESSERE UN COMODO SPAZIO ADIBITO A DISPENSA O RIPOSTIGLIO.

THE FULL-HEIGHT DOOR IN BRONZE GLASS WITH TITANIUM FRAME CONCEALS A COMPARTMENT THAT CAN CONTAIN USEFUL APPLIANCES OR BE USED SIMPLY AS A USEFUL LARDER OR STORAGE SPACE.







L'ESTETICA DELLA COMPOSIZIONE È CARATTERIZZATA DALL'ANTA LACCATATA CON DECORO ASTRATTO IN RILIEVO, NELLA FINITURA CANAPA CON DISEGNI CASTORO. I TOCCHI DI LACCATO VERDE POSITANO DEL MOBILE E DEI PENSILI A GIORNO CREANO PIACEVOLI CONTRASTI CON I TONI CALDI DELL'AMBIENTE.

THE LOOK OF THIS COMPOSITION IS CHARACTERISED BY THE LACQUERED DOOR WITH AN ABSTRACT DECORATION IN RELIEF, SHOWN HERE IN HEMP FINISH WITH DESIGNS IN BEAVER BROWN. THE TOUCHES OF POSITANO GREEN LACQUER ON THE SIDEBOARD AND OPEN WALL UNITS CREATE A PLEASANT CONTRAST WITH THE WARM COLOURS OF THE SPACE.





QUESTA SOLUZIONE OFFRE UN VALIDO APPOGGIO PER LA TV, IN UN LIVING CREATO GRAZIE ALL'UNIONE DEL MOBILE LIVING LINEA "PLAN" CON LA LIBRERIA A SVILUPPO VERTICALE.

THIS SOLUTION OFFERS A VALID SOLUTION FOR HOUSING THE TV IN A LIVING AREA CREATED BY COMBINING THE "PLAN" LIVING CABINET AND TALL BOOKSHELF.

OPZ. 8531D

LACCATO CANAPA CON
DECORO ASTRATTO A RILIEVO CASTORO

HEMP LACQUERED WITH BEAVER ABSTRACT DECORATION IN RELIEF

*materiale non disponibile



OPZ. 5558

TOP / WORKTOP

UNICOLOR CARNICO PROFILO "U3"

UNICOLOR CARNICO "U3" PROFILE

OPZ. TCBRZ

TELAIO ALLUMINIO TITANIO
CON VETRO BRONZO

TITANIUM ALUMINIUM FRAME
WITH BRONZE GLASS

OPZ. 1324

IMPIALLACCIATO PORO SEMIAPERTO SENZA NODO NOCE CANALETTO FIAMMA VERTICALE
SEMI-OPEN PORE VENEERED CANALETTO WALNUT VERTICAL GRAIN WITHOUT KNOTS

OPZ. 414

ZOCCOLO / PLINTH

ALLUMINIO FINITURA TITANIO OSSIDATO

ALUMINIUM TITANIUM OXIDIZED FINISH

OPZ. 9531

LACCATO OPACO FUMO
SMOKE MATT LACQUERED

OPZ. 8471

LACCATO OPACO VERDE POSITANO
POSITANO GREEN MATT LACQUERED

OPZ. LM12

LACCATO OPACO FINITURA MALTA CON FONDO CEMENTO DARK GREY
MATT LACQUERED MORTAR FINISH WITH DARK GREY CEMENT SURFACE



Bridge 14

IMPIALLACCIATO SPAZZOLATO MATERICO CON NODO ROVERE GRAFITE FIAMMA VERTICALE
LACCATO OPACO FINITURA MALTA CON FONDO CEMENTO MINK
TELAIO ALLUMINIO NERO CON VETRO SATINATO

BRUSHED VENEERED GRAPHITE OAK WITH VERTICAL GRAIN AND KNOTS, TEXTURED FINISH
MATT LACQUERED MORTAR FINISH WITH MINK CEMENT SURFACE
BLACK ALUMINIUM FRAME WITH SATIN GLASS







IL BLOCCO PENISOLA E LE ANTE DEL MOBILE LIVING LINEA "PLAN" SONO LACCATE EFFETTO MALTA MINK IL CUI TONO DELICATO CONTRASTA CON LA PRESENZA SCENICA DEL ROVERE GRAFITE, VERO PROTAGONISTA DELLA COMPOSIZIONE.

THE PENINSULA BLOCK AND DOORS OF "PLAN" LIVING CABINET ARE MADE FROM MINK MORTAR. THIS DELICATE COLOUR CONTRASTS WITH THE SCENIC GRAPHITE OAK, WHICH IS THE REAL STAR OF THE COMPOSITION.





IL LIVING È FORMATO DA DUE BLOCCHI, SEPARATI FISICAMENTE MA UNITI STILISTICAMENTE. LE LIBRERIE, CON I MONTANTI IN METALLO ED I RIPIANI IN ROVERE GRAFITE, SI ADATTANO PERFETTAMENTE ALLA FUNZIONE DI FILTRO E SEPARAZIONE DELL'AMBIENTE CUCINA DA QUELLO LIVING.

THE LIVING AREA IS FORMED OF TWO BLOCKS THAT ARE PHYSICALLY SEPARATE BUT STYLISTICALLY UNITED. THE BOOKSHELVES, WITH UPRIGHTS IN METAL AND GRAPHITE OAK SHELVES, ARE PERFECTLY SUITED TO THE TASK OF SEPARATING THE KITCHEN AND LIVING AREA.

OPZ. LM15

LACCATO OPACO FINITURA MALTA
CON FONDO CEMENTO MINK
MATT LACQUERED MORTAR FINISH
WITH MINK CEMENT SURFACE

OPZ. NU

ZOCCOLO / PLINTH
ALLUMINIO FINITURA URBAN OSSIDATO
ALUMINIUM URBAN OXIDIZED FINISH

OPZ. NCSAT

TELAIO ALLUMINIO NERO CON VETRO SATINATO
BLACK ALUMINIUM FRAME WITH SATIN GLASS

OPZ. 5403

IMPIALLACCIATO SPAZZOLATO MATERICO CON NODO
ROVERE GRAFITE FIAMMA VERTICALE
BRUSHED VENEERED GRAPHITE OAK WITH VERTICAL GRAIN AND KNOTS,
TEXTURED FINISH

OPZ. 8471

LACCATO OPACOVERDE POSITANO
POSITANO GREEN MATT LACQUERED

OPZ. 0717

TOP / WORKTOP
FENIX CASTORO PROFILO "PP"
BEAVER FENIX WITH "PP" PROFILE



Bridge 15

IMPIALLACCIATO ROVERE LACCATO A PORO APERTO OPACO GRIGIO CENERE FIAMMA ORIZZONTALE
LACCATO LUCIDO FUMO
TELAIO ALLUMINIO TITANIO CON VETRO BRONZO
OPEN PORE MATT LACQUERED ASH GREY OAK VENEERED WITH HORIZONTAL GRAIN
SMOKE GLOSSY LACQUERED
TITANIUM ALUMINIUM FRAME WITH BRONZE GLASS





LA SUPERFICIE DEL PIANO SCORREVOLE IN LAMINATO OLD DARK, CELA ALLO SGUARDO LA PRESENZA DELL'AREA FUOCHI E DEL LAVABO. UNA PENISOLA/MONOLITE TRASFORMABILE A SECONDA DELLE PROPRIE ESIGENZE, CHE SA UNIRE ESTETICA MINIMALE E FUNZIONALITÀ IN UN UNICO, ORIGINALE ED ELEGANTE, ELEMENTO DI ARREDO.

THE SURFACE OF THE OF THE SLIDING TOP IN OLD DARK LAMINATE CONCEALS THE HOB AREA AND SINK. A PENINSULA/MONOLITH THAT CAN BE TRANSFORMED TO SUIT DIFFERENT REQUIREMENTS. IT COMBINES MINIMAL LOOKS AND FUNCTIONALITY IN A UNIQUE, ORIGINAL AND ELEGANT PIECE OF FURNITURE.





OPZ. LM13

TOP / WORKTOP

LAMINATO OLD DARK FINITURA URBAN ABS 1

OLD DARK LAMINATE WITH URBAN FINISH ABS 1

OPZ. TCBRZ

TELAIO ALLUMINIO TITANIO CON VETRO BRONZO
TITANIUM ALUMINIUM FRAME WITH BRONZE GLASS

OPZ. 9532

LACCATO LUCIDO FUMO
SMOKE GLOSSY LACQUERED

OPZ. 5418

IMPIALLACCIATO ROVERE LACCATO A PORO APERTO OPACO
GRIGIO CENERE FIAMMA ORIZZONTALE
OPEN PORE MATT LACQUERED ASH GREY OAK VENEERED WITH HORIZONTAL GRAIN

OPZ. 9531

ZOCCOLO / PLINTH

FUMO

SMOKE



Bridge 16

GRES LAMINAM NERO FINITURA BLEND TELAIO ALLUMINIO LACCATO OPACO BISTRO
TELAIO ALLUMINIO TITANIO CON VETRO BRONZO

BLEND FINISH BLACK GRES LAMINAM, BISTRO MATT LACQUERED ALUMINIUM FRAME
TITANIUM ALUMINIUM FRAME WITH BRONZE GLASS



IL TOP SAGOMATO IN LAMINATO OLD WHITE È IN GRADO DI SLITTARE IN DIAGONALE SUL PIANO DELLE BASI RIBASSATE, IN MODO TALE DA POTER ESSERE UTILIZZATO COMODAMENTE COME ALTERNATIVA AL TAVOLO PRESENTE NELLA ZONA PRANZO.

THE SHAPED TOP IN OLD WHITE LAMINATE CAN SLIDE DIAGONALLY ON THE TOPS OF THE LOWERED BASE UNITS. THIS MEANS THAT IT CAN BE USED AS A TABLE IN THE LUNCH AREA.







OPZ. G43B

GRES LAMINAM NERO FINITURA BLEND TELAIO ALLUMINIO LACCATO OPACO BISTRO
BLEND FINISH BLACK GRES LAMINAM, BISTRO MATT LACQUERED ALUMINIUM FRAME

OPZ. 5418

IMPIALLACCIATO ROVERE LACCATO A PORO APERTO OPACO
GRIGIO CENERE FIAMMA ORIZZONTALE
OPEN PORE MATT LACQUERED ASH GREY OAK VENEERED WITH HORIZONTAL GRAIN

OPZ. LM11

LAMINATO OLD WHITE FINITURA URBAN ABS 1
OLD WHITE LAMINATE WITH URBAN FINISH ABS 1

OPZ. TCBRZ

TELAIO ALLUMINIO TITANIO
CON VETRO BRONZO
TITANIUM ALUMINIUM FRAME
WITH BRONZE GLASS

OPZ. L933

TOP / WORKTOP
LAMINATO FERRO BORDO ABS 1
IRON LAMINATE ABS 1 EDGE

OPZ. 414

ZOCCOLO / PLINTH
ALLUMINIO FINITURA TITANIO OSSIDATO
ALUMINIUM TITANIUM OXIDIZED FINISH



Bridge 17

IMPIALLACCIATO SPAZZOLATO MATERICO CON NODO ROVERE NATURALE FIAMMA VERTICALE
LACCATO OPACO CASTORO

BRUSHED VENEERED NATURAL OAK WITH VERTICAL GRAIN AND KNOTS, TEXTURED FINISH
BEAVER MATT LACQUERED







OPZ. 831

TOP / WORKTOP

LAMINATO CAFFÈ FINITURA CRISTAL ABS 1
COFFEE LAMINATE WITH CRYSTAL FINISH ABS 1

OPZ. 8157

LACCATO OPACO ROSSO TOSCANO
TUSCAN RED MATT LACQUERED

OPZ. 8907 - OPZ. 8908

LACCATO CASTORO OPACO E LUCIDO
BEAVER GLOSSY AND MATT LACQUERED

OPZ. 5404

IMPIALLACCIATO SPAZZOLATO MATERICO CON NODO
ROVERE NATURALE FIAMMA VERTICALE
BRUSHED VENEERED NATURAL OAK WITH VERTICAL GRAIN AND KNOTS,
TEXTURED FINISH

OPZ. 414

ZOCCOLO / PLINTH

ALLUMINIO FINITURA TITANIO OSSIDATO
ALUMINIUM TITANIUM OXIDIZED FINISH



Bridge 18

IMPIALLACCIATO SPAZZOLATO MATERICO CON NODO ROVERE POLVERE FIAMMA VERTICALE

LACCATO OPACO GRIGIO PIOMBO

VETRO SATINATO GRIGIO PIOMBO TELAIO ALLUMINIO OPACO IN TINTA

BRUSHED VENEERED DUST OAK WITH VERTICAL GRAIN AND KNOTS, TEXTURED FINISH

LEAD GREY MATT LACQUERED

LEAD GREY PAINTED SATIN GLASS WITH MATCHING ALUMINIUM FRAME MATT FINISH







VOGLIA DI RELAX, IN UNA ZONA LIVING SEMPLICE E LINEARE, CARATTERIZZATA DALL'INTENSO GRIGIO PIOMBO E DALL'ELEGANTE BOISERIE IN ROVERE POLVERE CON NODINI. GLI ELEMENTI A GIORNO SONO IN METALLO ED IN FINITURA COORDINATA.

RELAX IN A SIMPLE AND LINEAR LIVING AREA CHARACTERISED BY INTENSE LEAD GREY AND ELEGANT WOOD PANELLING IN DUST OAK VENEER. THE OPEN ELEMENTS ARE MADE FROM METAL WITH A COORDINATED FINISH.



OPZ. V9537

VETRO VERNICIATO SATINATO GRIGIO PIOMBO TELAIO ALLUMINIO OPACO IN TINTA
LEAD GREY PAINTED SATIN GLASS WITH MATCHING ALUMINIUM FRAME MATT FINISH

OPZ. 5402

IMPIALLACCIATO SPAZZOLATO MATERICO CON NODO
ROVERE POLVERE FIAMMA VERTICALE
BRUSHED VENEERED DUST OAK WITH VERTICAL GRAIN AND KNOTS, TEXTURED FINISH

OPZ. 0718

TOP / WORKTOP
FENIX FUMO PROFILO "PP"
SMOKE FENIX WITH "PP" PROFILE

OPZ. 8907

LACCATO OPACO CASTORO
BEAVER MATT LACQUERED

OPZ. 9537

LACCATO OPACO GRIGIO PIOMBO
LEAD GREY MATT LACQUERED

OPZ. 9531

ZOCCOLO / PLINTH
FUMO
SMOKE



Bridge 19

LACCATO VINTAGE EFFETTO METALLO FERRO
IMPIALLACCIATO SPAZZOLATO MATERICO CON NODO ROVERE GRIGIO NEBBIA FIAMMA VERTICALE

VINTAGE LACQUERED METAL EFFECT, IRON COLOUR
BRUSHED VENEERED MIST GREY OAK WITH VERTICAL GRAIN AND KNOTS, TEXTURED FINISH





UNA CUCINA UNICA CARATTERIZZATA DALLA PRESENZA DI DIVERSI MATERIALI, CHE SI ABBINANO PERFETTAMENTE IN UNA SCALATURA DI NUANCES CHIARE MA NON BANALI. IL PIANO SCORREVOLE SAGOMATO AGGIUNGE ALL'OCCORRENZA UN PRATICO TAVOLO ALL'ISOLA CENTRALE.

A UNIQUE KITCHEN CRAFTED FROM DIFFERENT MATERIALS WHICH BLEND TO PERFECTION IN A BALANCED SEQUENCE OF MUTED, YET FRESH, NUANCES. WHENEVER YOU NEED, THE CONTOURED TOP SLIDES OUT TO BECOME A HANDY TABLE SURFACE IN THE CENTRAL ISLAND.



GLI ACCESSORI INTERNI ALLE BASI E ALLE COLONNE AIUTANO A RAZIONALIZZARE LO SPAZIO DI CONTENIMENTO, E SONO REALIZZATI CON MATERIALI RESISTENTI ED ESTETICAMENTE ACCATTIVANTI.

MADE FROM RESILIENT YET AESTHETICALLY PLEASING MATERIALS, THE BASE UNITS AND COLUMNS FEATURE A CLEVER DESIGN WHICH SAVES ON STORAGE SPACE.



OPZ. 5401

IMPIALLACCIATO SPAZZOLATO MATERICO CON NODO
ROVERE GRIGIO NEBBIA FIAMMA VERTICALE
*BRUSHED VENEERED MIST GREY OAK WITH VERTICAL GRAIN AND KNOTS,
TEXTURED FINISH*

OPZ. LM12

TOP / WORKTOP

LAMINATO OLD GREY FINITURA URBAN ABS 1
OLD GREY LAMINATE WITH URBAN FINISH ABS 1

OPZ. 9506

LACCATO VINTAGE EFFETTO METALLO FERRO
VINTAGE LACQUERED METAL EFFECT, IRON COLOUR

OPZ. 414

ZOCCOLO / PLINTH
ALLUMINIO FINITURA TITANIO OSSIDATO
ALUMINIUM TITANIUM OXIDIZED FINISH

VETRINE E MOBILI LIVING LINEA "PLAN"

SHOWCASE CABINETS AND "PLAN" LIVING CABINETS





MOBILE CON ANTE A VETRO SATINATO,
TELAIO E STRUTTURA IMPIALLACCIATO SPAZZOLATO MATERICO CON NODO
ROVERE NATURALE FIAMMA VERTICALE (OPZ. 5404)

CABINET WITH SATIN GLASS DOORS
FRAME AND STRUCTURE: BRUSHED VENEERED NATURAL OAK WITH VERTICAL GRAIN AND KNOTS, TEXTURED FINISH (OPT. 5404)

L/W 2000 - A/H 2060 - P/D 480



MOBILE CON ANTE A VETRO SATINATO E CASSETTI,
TELAIO E STRUTTURA IMPIALLACCIATO SPAZZOLATO MATERICO CON NODO
ROVERE GRAFITE FIAMMA VERTICALE (OPZ. 5403)

*CABINET WITH SATIN GLASS DOORS AND DRAWERS
FRAME AND STRUCTURE: BRUSHED VENEERED GRAPHITE OAK WITH KNOTS, TEXTURED FINISH (OPT. 5403)*

L/W 2000 - A/H 930 - P/D 480



MOBILE CON ANTE A VETRO SATINATO,
TELAIO E STRUTTURA LACCATO VINTAGE
EFFETTO METALLO URBAN (OPZ.7894)

*CABINET WITH SATIN GLASS DOORS
FRAME AND STRUCTURE: VINTAGE LACQUERED METAL EFFECT, URBAN COLOUR (OPT.7894)*

L/W 2000 - A/H 1410 - P/D 480



ANTE E STRUTTURA
IMPIALLACCIATO SPAZZOLATO
MATERICO CON NODO
ROVERE GRAFITE FIAMMA VERTICALE
(OPZ. 5403)

ELEMENTI A GIORNO
LACCATO OPACO CASTORO
(OPZ. 8907)

DOORS AND STRUCTURE
BRUSHED VENEERED GRAPHITE OAK WITH
VERTICAL GRAIN AND KNOTS, TEXTURED FINISH
(OPT. 5403)

OPEN UNITS
BEAVER MATT LACQUERED (OPT. 8907)

L/W 2144 - A/H 604 - P/D 504



ANTE E STRUTTURA
IMPIALLACCIATO PORO SEMIAPERTO
SENZA NODO NOCE CANALETTO
FIAMMA VERTICALE (OPZ. 1324)

ELEMENTI A GIORNO
LACCATO OPACO FUMO (OPZ. 9531)

DOORS AND STRUCTURE
SEMI-OPEN PORE VENEERED CANALETTO WALNUT
VERTICAL GRAIN WITHOUT KNOTS (OPT. 1324)

OPEN UNITS
SMOKE MATT LACQUERED (OPT. 9531)

L/W 2444 - A/H 534 - P/D 504



ANTE
GRES LAMINAM SALE FINITURA FOCOS
TELAIO ALLUMINIO LACCATO OPACO
FUMO (OPZ. LG70F)

STRUTTURA ED ELEMENTI A GIORNO
LACCATO OPACO FUMO (OPZ. 9531)
IMPIALLACCIATO SPAZZOLATO
MATERICO ROVERE TABACCO
(OPZ. 5405)

DOORS
FOKOS FINISH SALE GRES LAMINAM, SMOKE MATT
LACQUERED ALUMINIUM FRAME (OPT. LG70F)

STRUCTURE AND OPEN UNITS
SMOKE MATT LACQUERED AND BRUSHED VENEERED
TOBACCO OAK WITH KNOTS, TEXTURED FINISH
(OPT. 5405)

L/W 3344 - A/H 1134 - P/D 504



ANTE
GRES LAMINAM NERO FINITURA BLEND
TELAIO ALLUMINIO LACCATO
OPACO BISTRO (OPZ. G43B)

STRUTTURA ED ELEMENTI A GIORNO
LACCATO OPACO
GRIGIO BROMO (OPZ. 9553)

DOORS
BLEND FINISH BLACKGRES LAMINAM, BISTRO MATT
LACQUERED ALUMINIUM FRAME (OPT. G43B)

STRUCTURE AND OPEN UNITS
BROMINE GREY MATT LACQUERED (OPT. 9553)

L/W 1844 - A/H 894 - P/D 504



ANTE
LACCATO OPACO FINITURA MALTA
CON FONDO CEMENTO DARK GREY
(OPZ. LM12)

STRUTTURA
IMPIALLACCIATO PORO SEMIAPERTO
SENZA NODO NOCE CANALETTO
FIAMMA VERTICALE (OPZ. 1324)

ELEMENTI A GIORNO E CASSETTO
LACCATO OPACO VERDE POSITANO
(OPZ. 8471)

DOORS
MATT LACQUERED MORTAR FINISH WITH DARK GREY
CEMENT SURFACE (OPT. LM12)

STRUCTURE
SEMI-OPEN PORE VENEERED CANALETTO WALNUT
VERTICAL GRAIN WITHOUT KNOTS (OPT. 1324)

OPEN UNITS AND DRAWER
POSITANO GREEN MATT LACQUERED (OPT. 8471)

L/W 1844 - A/H 964 - P/D 504



ANTE E STRUTTURA
IMPIALLACCIATO SPAZZOLATO
MATERICO CON NODO
ROVERE POLVERE
FIAMMA VERTICALE (OPZ. 5402)

ELEMENTI A GIORNO
LACCATO OPACO FUMO (OPZ. 9531)

DOORS AND STRUCTURE
BRUSHED VENEERED DUST OAK WITH VERTICAL
GRAIN AND KNOTS, TEXTURED FINISH (OPT. 5402)

OPEN UNITS
SMOKE MATT LACQUERED (OPT. 9531)

L/W 2144 - A/H 964 - P/D 504

ANTE
LACCATO OPACO FINITURA MALTA
CON FONDO CEMENTO DARK GREY
(OPZ. LM12)

STRUTTURA E CASSETTI
IMPIALLACCIATO PORO SEMIAPERTO
SENZA NODO ROVERE TERMOCOTTO
FIAMMA VERTICALE
(OPZ. 5410)

DOORS
MATT LACQUERED MORTAR FINISH WITH DARK GREY
CEMENT SURFACE (OPT. LM12)

STRUCTURE AND DRAWER
SEMI-OPEN PORE VENEERED THERMO-TREATED OAK
VERTICAL GRAIN WITHOUT KNOTS (OPT. 5410)

L/W 1244 - A/H 1494 - P/D 504



ANTE
LACCATO OPACO FINITURA MALTA
CON FONDO CEMENTO MINK
(OPZ. LM15)

STRUTTURA
IMPIALLACCIATO SPAZZOLATO
MATERICO CON NODO
ROVERE GRAFITE FIAMMA VERTICALE
(OPZ. 5403)

ELEMENTI A GIORNO
LACCATO OPACO VERDE POSITANO
(OPZ. 8471)

DOORS
MATT LACQUERED MORTAR FINISH
WITH MINK CEMENT SURFACE (OPT. LM15)

STRUCTURE
BRUSHED VENEERED GRAPHITE OAK WITH VERTICAL
GRAIN AND KNOTS, TEXTURED FINISH (OPT. 5403)

OPEN UNITS
POSITANO GREEN MATT LACQUERED (OPT. 8471)

L/W 1244 - A/H 1374 - P/D 504

FINITURE & COLORI

FINISHES & COLOURS

UNA AMPIA GAMMA DI COLORI DI TENDENZA
E FINITURE INNOVATIVE ARRICCHISCONO E
COMPLETANO IL PROGRAMMA PER CONSENTIRE LA
MASSIMA PERSONALIZZAZIONE DI OGNI AMBIENTE.

*A WIDE RANGE OF TREND COLOURS AND INNOVATIVE FINISHES
ENRICHES AND COMPLETES THE PROGRAMME ENSURING MAXIMUM
CUSTOMISATION FOR EACH SETTING.*



ANTE IMPIALLACCIATE
ROVERE SPAZZOLATE
MATERICHE CON NODO

BRUSHED VENEERED DOORS
IN OAK WITH KNOTS TEXTURED FINISH

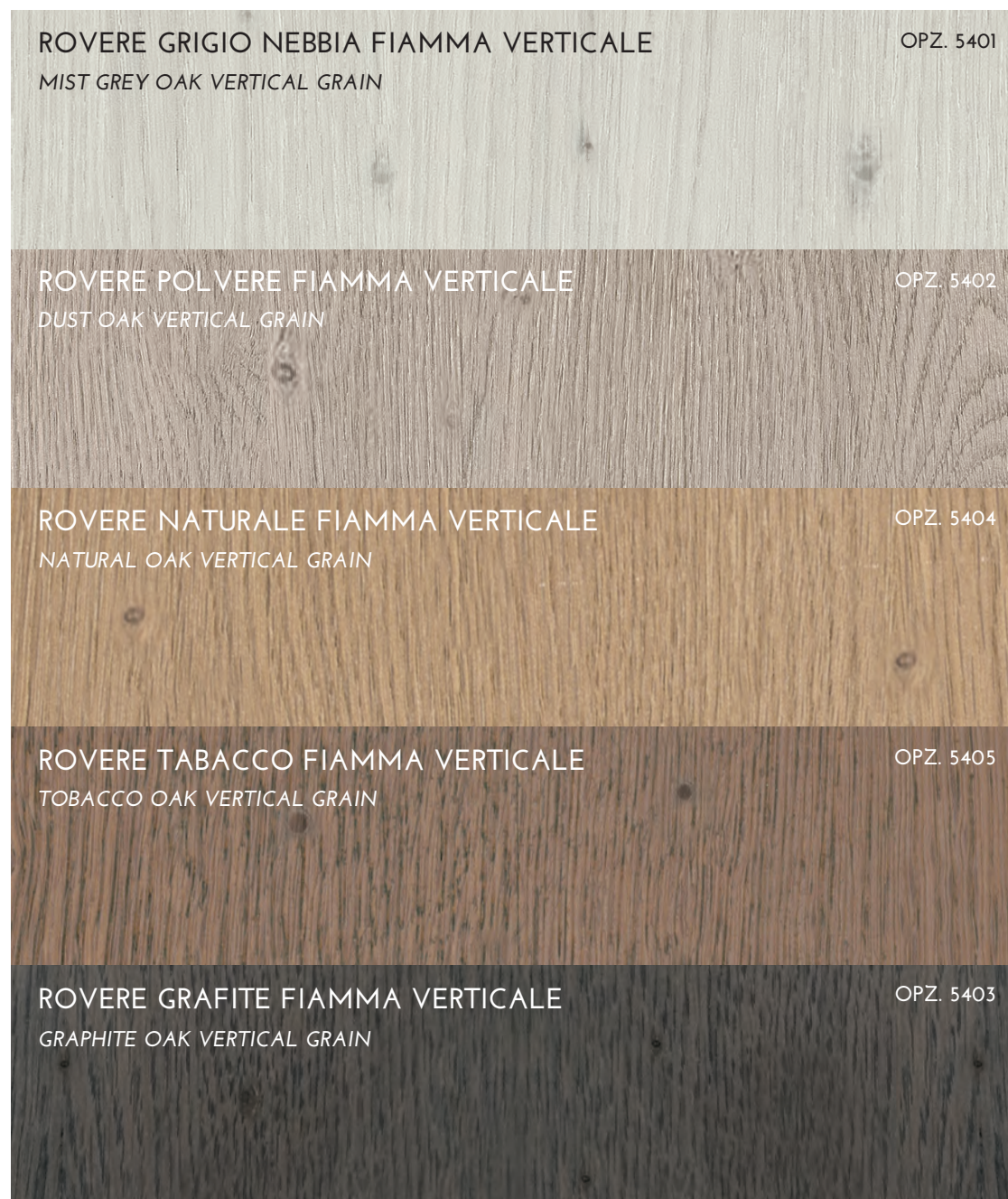

ANTE IMPIALLACCIATE
PORO SEMIAPERTO
SENZA NODO

SEMI-OPEN PORE VENEERED DOORS
WITHOUT KNOTS



ANTE IMPIALLACCIATE
ROVERE LACCATO
A PORO APERTO OPACO

OPEN-PORE VENEERED DOORS
MATT LACQUERED OAK

ANTE LACCATE OPACHE
FINITURA MALTA
CON FONDO CEMENTO

MATT LACQUERED MORTAR FINISH DOORS
WITH CEMENT SURFACE

WHITE	OPZ. LM11
MINK	OPZ. LM15
DARK GREY	OPZ. LM12
LIGHT GREY	OPZ. LM14
BLACK BOARD	OPZ. LM13

AVORIO FINITURA BLEND
TELAIO ALLUMINIO LACCATO OPACO CASTORO
*BLEND FINISH IVORY,
BEAVER MATT LACQUERED ALUMINIUM FRAME*

SALE FINITURA FOKOS
TELAIO ALLUMINIO LACCATO OPACO FUMO
*FOKOS FINISH SALE,
SMOKE MATT LACQUERED ALUMINIUM FRAME*

TERRA FINITURA FOKOS
TELAIO ALLUMINIO LACCATO OPACO CASTORO
*FOKOS FINISH EARTH,
BEAVER MATT LACQUERED ALUMINIUM FRAME*

PIETRA DI SAVOIA FINITURA NATURALE
TELAIO ALLUMINIO LACCATO OPACO ARGILLA
*NATURALE FINISH STONE OF SAVOIA,
CLAY MATT LACQUERED ALUMINIUM FRAME*

NERO FINITURA BLEND
TELAIO ALLUMINIO LACCATO OPACO BISTRO
*BLEND FINISH BLACK,
BISTRO MATT LACQUERED ALUMINIUM FRAME*

ANTE
GRES LAMINAM
GRES LAMINAM DOORS

PER I CODICI CONSULTARE IL LISTINO
E FARE RIFERIMENTO ALLE DIVERSE
TIPOLOGIA DI ANTE ED APERTURE

CONSULT THE PRICE LIST FOR THE CODES
AND REFER TO THE VARIOUS TYPES OF
DOORS AND OPENING SYSTEMS.



ANTE LACCATE VINTAGE
EFFETTO METALLO

VINTAGE LACQUERED DOORS
METAL EFFECT

PELTRO PEWTER	OPZ. 9549
BRONZO BRONZE	OPZ. 8904
FERRO IRON	OPZ. 9506
URBAN URBAN	OPZ. 7894

ANTE LACCATE
LUCIDE E OPACHE

GLOSSY AND MATT
LACQUERED DOORS

-  [CLICCA QUI PER LA GAMMA COLORI DISPONIBILI](#)
-  [CLICK HERE FOR THE RANGE OF AVAILABLE COLORS](#)
-  [ZUR FARBAUSWAHL HIER KLICKEN](#)

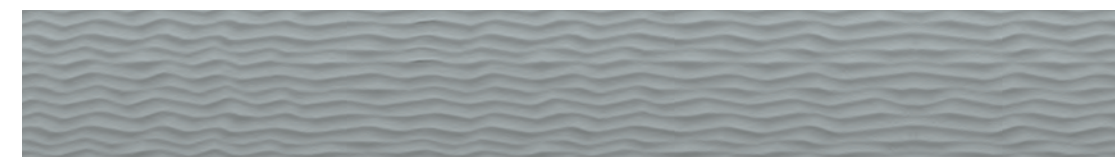

ANTE 'DUNE'
LACCATE OPACHE

'DUNE' MATT LACQUERED DOORS

DISPONIBILI NEI COLORI LACCATI:

AVAILABLE IN LACQUERED COLOURS:

VETRO VERNICIATO
SATINATO E LUCIDO
TELAIO ALLUMINIO
OPACO IN TINTA

PAINTED SATIN AND GLOSSY GLASS
WITH MATCHING ALUMINIUM FRAME
MATT FINISH

TONI CALDI
WARM COLOURS

BIANCO CALDO WARM WHITE
CANAPA HEMP
BRONZO BRONZE
CASTORO BEAVER
FUMO SMOKE
GIALLO AMBRA AMBER YELLOW
ROSSO TOSCANO TUSCAN RED
GRIGIO PIOMBO LEAD GREY
BISTRO BISTRO

PER I CODICI CONSULTARE IL LISTINO
E FARE RIFERIMENTO ALLE DIVERSE
TIPOLOGIA DI ANTE ED APERTURE
CONSULT THE PRICE LIST FOR THE CODES
AND REFER TO THE VARIOUS TYPES OF
DOORS AND OPENING SYSTEMS.

BIANCO ASSOLUTO
ABSOLUTE WHITE

CENERE
ASH

VERDE LICHENE
LICHEN GREEN

VERDE POSITANO
POSITANO GREEN

GRIGIO BROMO
BROMINE GREY

NERO
BLACK

VETRO VERNICIATO
SATINATO E LUCIDO
TELAIO ALLUMINIO
OPACO IN TINTA

PAINTED SATIN AND GLOSSY GLASS
WITH MATCHING ALUMINIUM FRAME MATT FINISH

TONI FREDDI
COLD COLOURS

PER I CODICI CONSULTARE IL LISTINO
E FARE RIFERIMENTO ALLE DIVERSE
TIPOLOGIA DI ANTE ED APERTURE

CONSULT THE PRICE LIST FOR THE CODES
AND REFER TO THE VARIOUS TYPES OF
DOORS AND OPENING SYSTEMS.



TELAIO
TITANIO
CON VETRO
SATINATO
TITANIUM FRAME
WITH SATIN GLASS
OPZ. TCSAT



TELAIO
TITANIO
CON VETRO
BRONZO
TITANIUM FRAME
WITH BRONZE GLASS
OPZ. TCBRZ

TELAIO ALLUMINIO TITANIO
VETRO SATINATO O BRONZO

TITANIUM ALUMINIUM FRAME
SATIN OR BRONZE GLASS



TELAIO
NERO
CON VETRO
SATINATO
BLACK FRAME
WITH SATIN GLASS
OPZ. NCSAT



TELAIO
NERO
CON VETRO
BRONZO
BLACK FRAME
WITH BRONZE GLASS
OPZ. NCBRZ

TELAIO ALLUMINIO NERO
VETRO SATINATO O BRONZO

BLACK ALUMINIUM FRAME
SATIN OR BRONZE GLASS

ANTE LACCATE OPACHE CON
DECORO ASTRATTO A RILIEVO

MATT LACQUERED DOORS WITH
ABSTRACT DECORATION IN RELIEF

* materiale non disponibile



[CLICCA QUI PER LA GAMMA COLORI DISPONIBILI](#)

[CLICK HERE FOR THE RANGE OF AVAILABLE COLORS](#)

[ZUR FARBAUSWAHL HIER KLICKEN](#)

* opz 9547 cenere non disponibile

TITANIO OSSIDATO TITANIUM OXIDIZED	OPZ. 414	FINITURE GOLE, ZOCCOLI E PROFILI SPAZZOLATI FINGER RAILS, PROFILES AND PLINTHS BRUSHED FINISHES
URBAN OSSIDATO URBAN OXIDIZED	OPZ. NU	BRILL * BRILL

* opz. 412 brill non disponibile per profili

BIANCO ASSOLUTO ABSOLUTE WHITE	OPZ. 740S	FINITURE GOLE, ZOCCOLI E PROFILI VERNICIATI A POLVERE OPACHI MATT FINGER RAILS, PROFILES AND PLINTHS POWDER COATED FINISHES
CENERE ASH	OPZ. 9547	BIANCO CALDO WARM WHITE
ROSA QUARZO QUARTZ PINK	OPZ. 8171	GIALLO AMBRA AMBER YELLOW
SALVIA SAGE	OPZ. 8443	ROSSO TOSCANO TUSCAN RED
ACQUAMARINA AQUAMARINE	OPZ. 8323	CASTORO BEAVER
VERDE ACQUA WATER GREEN	OPZ. 8473	VERDE LICHENE LICHEN GREEN
BLU FIORDALISO CORNFLOWER BLUE	OPZ. 8377	FUMO SMOKE
VERDE POSITANO POSITANO GREEN	OPZ. 8471	GRIGIO BROMO BROMINE GREY
BLU CADETTO CADET BLUE	OPZ. 8373	ARGILLA CLAY
NERO BLACK	OPZ. 7892	BISTRO BISTRO

TIPOLOGIA DI APERTURA DELLE ANTE DI CLOVER

OPENING SYSTEM VERSIONS FOR CLOVER DOORS

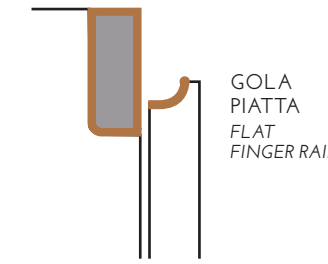

GOLA PIATTA
FLAT
FINGER RAIL

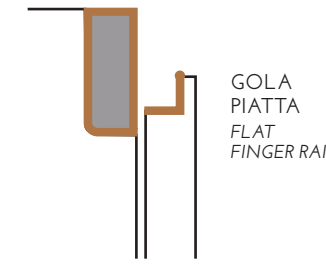

GOLA PIATTA
FLAT
FINGER RAIL

LUX

ANTA CON PROFILO PER APERTURE CON GOLA
DOOR WITH PROFILE FOR OPENINGS WITH FINGER RAIL

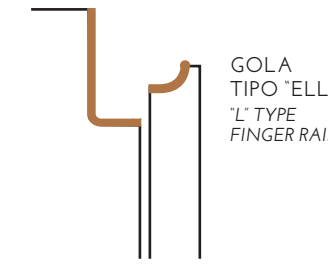

GOLA TIPO "ELLE"
"L" TYPE
FINGER RAIL

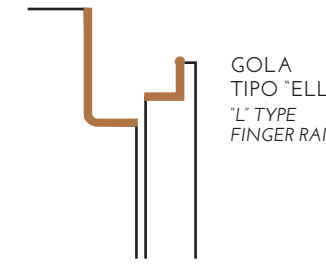

GOLA TIPO "ELLE"
"L" TYPE
FINGER RAIL

ANTA CON PROFILO CURVO
DOOR WITH CURVED PROFILE

ANTA CON PROFILO AD "ELLE"
DOOR WITH "L-SHAPED" PROFILE

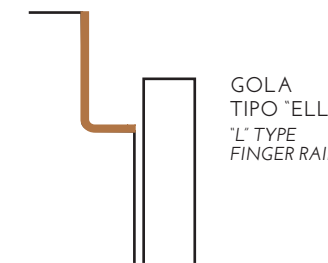

GOLA TIPO "ELLE"
"L" TYPE
FINGER RAIL

Neck

ANTA SENZA PROFILO PER APERTURA CON GOLA
DOOR WITHOUT PROFILE FOR FINGER RAIL OPENING

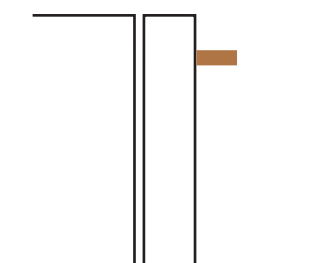

FRONTALE

ANTA CON MANIGLIA FRONTALE
FRONTAL / DOOR WITH FRONT HANDLE

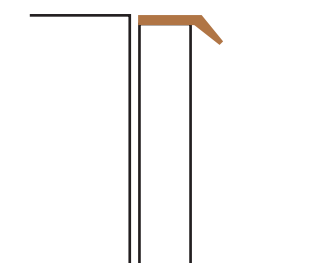

IN TESTA

ANTA CON MANIGLIA IN TESTA
TOP-MOUNTED DOOR WITH TOP-MOUNTED HANDLE

Bridge

ANTA QUADRATA CON MANIGLIA
SQUARE DOOR WITH HANDLE

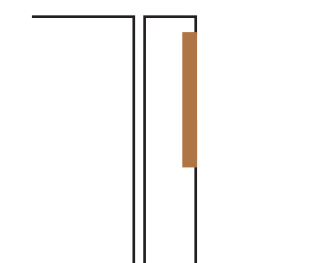

AD INCASSO

ANTA CON MANIGLIA INCASSATA
DOOR WITH RECESSED HANDLE

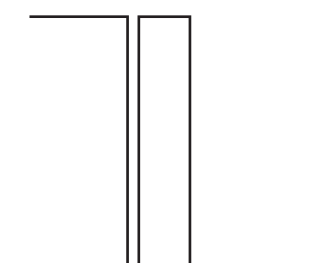

PUSH PULL

ANTA CON APERTURA PUSH PULL
DOOR WITH PUSH-PULL OPENING



INFORMAZIONI TECNICHE

TECHNICAL INFORMATION

| 01 | Lux | ANTA CON PROFILO CURVO |

DIMENSIONI / DIMENSIONS

ISOLA - COLONNE / ISLAND - COLUMNS

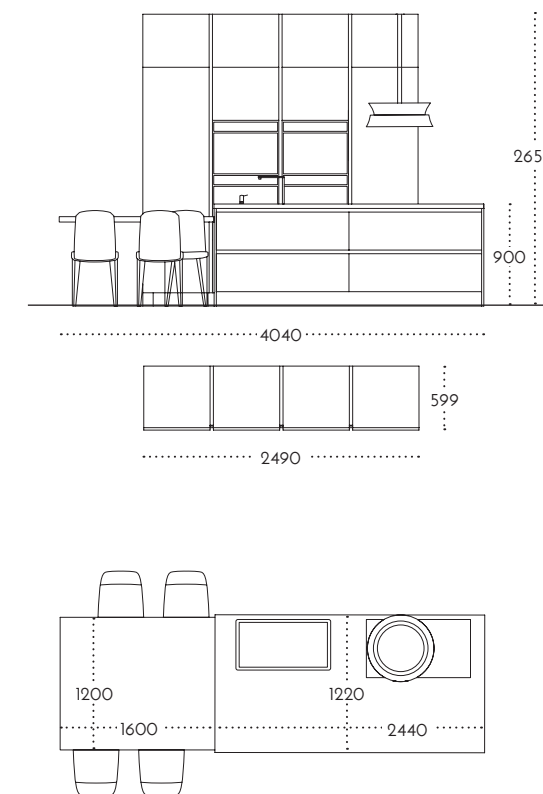

LIVING

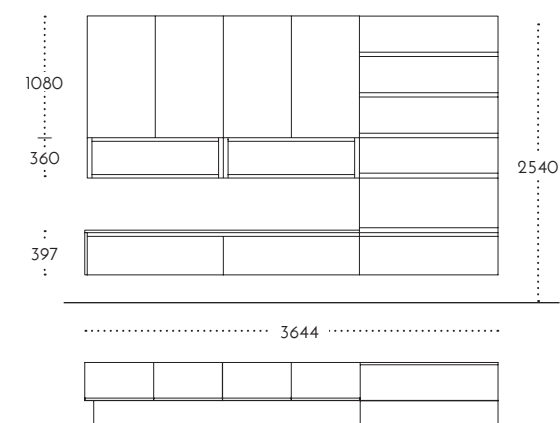

FINITURE / FINISHES

ANTA E TOP / DOORS AND WORKTOP

OPZ. 5410

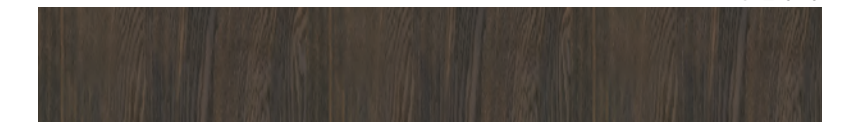

IMPIALLACCIATO PORO SEMIAPERTO SENZA NODO
ROVERE TERMOCOTTO FIAMMA VERTICALE
SEMI-OPEN PORE VENEERED THERMO-TREATED OAK VERTICAL GRAIN WITHOUT KNOTS

OPZ. CG71C



GRES LAMINAM TERRA FINITURA FOKOS
TELAIO ALLUMINIO LACCATO OPACO CASTORO
FOKOS FINISH EARTH GRES LAMINAM, BEAVER MATT LACQUERED ALUMINIUM FRAME

OPZ. TCBRZ



TELAIO ALLUMINIO TITANIO CON VETRO BRONZO
TITANIUM ALUMINIUM FRAME WITH BRONZE GLASS

GOLA E ZOCCOLO / FINGER RAIL AND PLINTH

OPZ. 414



ALLUMINIO FINITURA TITANIO OSSIDATO
ALUMINIUM TITANIUM OXIDIZED FINISH

SEDIA / CHAIR

GHIM

STRUTTURA METALLO VERNICIATO
MARRONE OPACO OPZ.MAO,
SEDUTA CRAZY 1006

MATT BROWN COATED
METAL STRUCTURE OPT. MAO,
CRAZY 1006 SEAT



DIMENSIONI / DIMENSIONS

BASI - COLONNE / BASE UNITS - COLUMNS

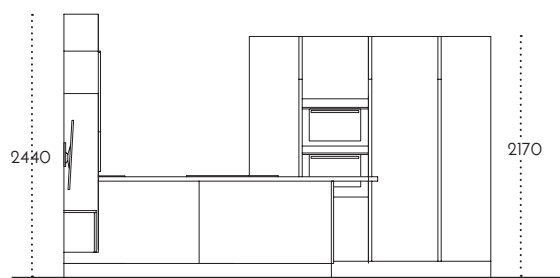

BASI - PENSILI - LIVING / BASE UNITS - WALL UNITS - LIVING

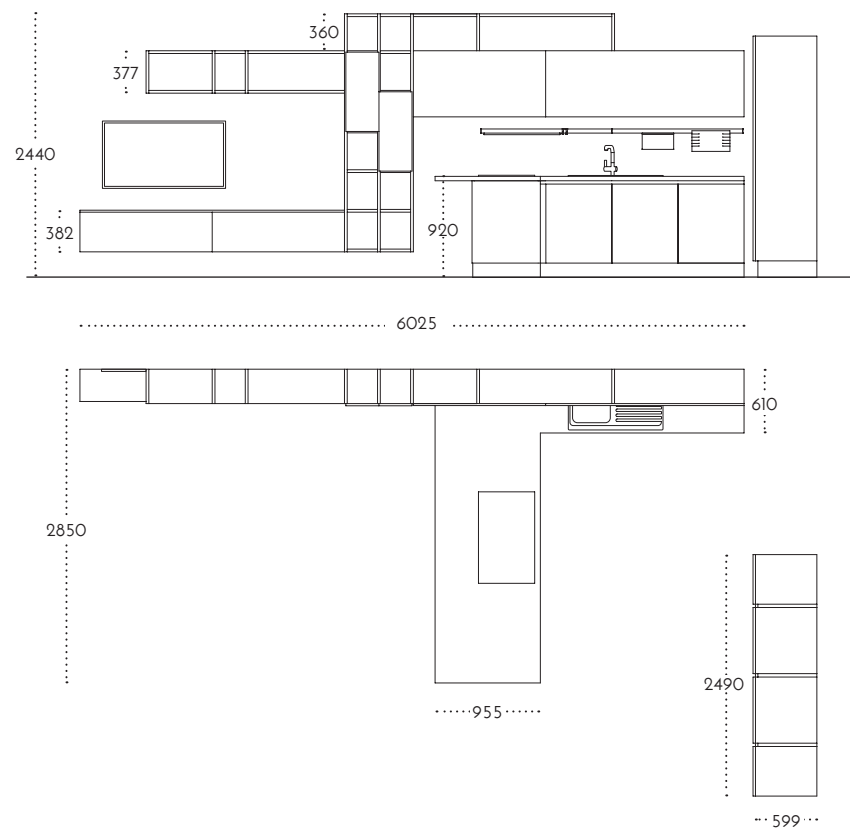

FINITURE / FINISHES

ANTE / DOORS



ANTA 'DUNE' LACCATA OPACA ARGILLA
'DUNE' MATT LACQUERED CLAY DOOR

OPZ. 9503



LACCATO OPACO CENERE
ASH MATT LACQUERED

OPZ. 9547



LACCATO OPACO GRIGIO PIOMBO
LEAD GREY MATT LACQUERED

OPZ. 9537



LAMINATO OLD GREY FINITURA URBAN
OLD GREY LAMINATE WITH URBAN FINISH

OPZ. LM12



GOLA, ZOCCOLO E LIBRERIA SOSPESA /
FINGER RAIL, PLINTH AND SUSPENDED BOOKSHELF

OPZ. 9531



FUMO
SMOKE

SGABELLO / STOOL

LIVIEN

STRUTTURA METALLO VERNICIATO
BISTRO G,
SEDUTA E SCHIENALE CUIO
RIGENERATO BIANCO Z05
BISTRO G-COATED METAL STRUCTURE,
WHITE REGENERATED LEATHER SEAT
AND BACKREST Z05



DIMENSIONI / DIMENSIONS

BASI / BASE UNITS

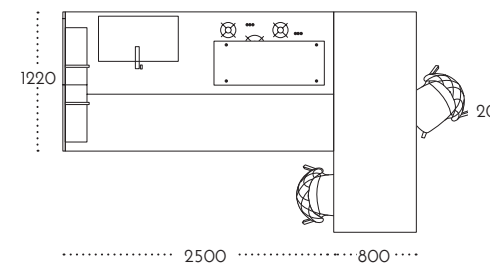
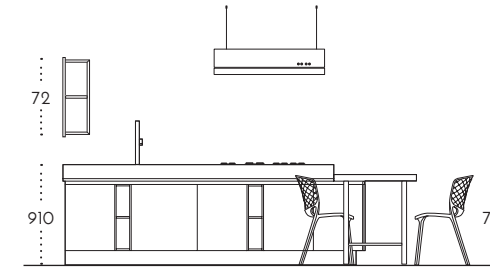

COLONNE / COLUMNS

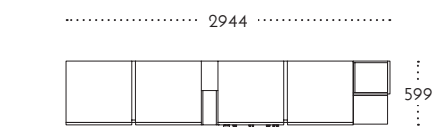
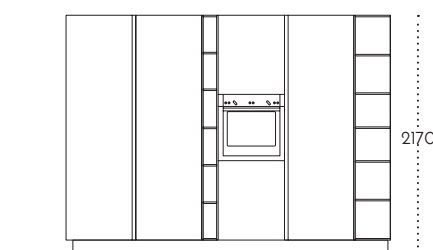

MOBILE LIVING LINEA 'PLAN' /
'PLAN' LIVING CABINET

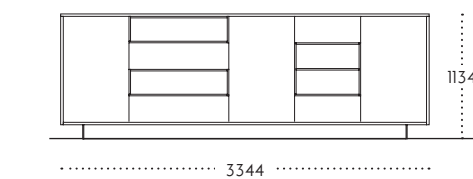

LIVING

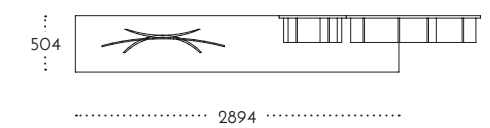
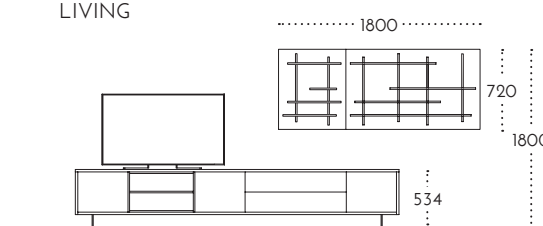

FINITURE / FINISHES

ANTE / DOORS



GRES LAMINAM SALE FINITURA FOKOS
TELAIO ALLUMINIO LACCATO OPACO FUMO
FOKOS FINISH SALE GRES LAMINAM, SMOKE MATT LACQUERED ALUMINIUM FRAME

OPZ. LG70F

ANTE, ELEMENTI A GIORNO E LIVING /
DOORS, OPEN UNITS AND LIVING

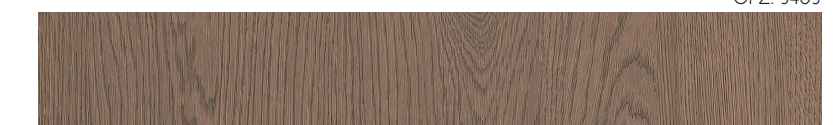

IMPIALLACCIATO SPAZZOLATO MATERICO CON NODO
ROVERE TABACCO FIAMMA VERTICALE
BRUSHED VENEERED TOBACCO OAK WITH VERTICAL GRAIN AND KNOTS,
TEXTURED FINISH

OPZ. 5405

ELEMENTI A GIORNO LIVING / LIVING OPEN UNITS

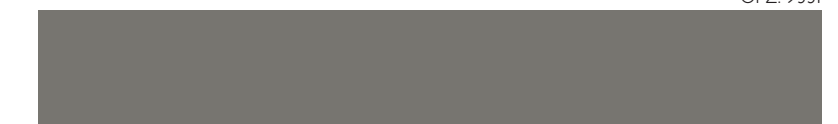

LACCATO OPACO FUMO
SMOKE MATT LACQUERED

OPZ. 9531

TOP / WORKTOP



STRATIFICATO 'HPL' BORDO FOLDING, RESINA FINITURA CLIMB OPZ. 1452
LAYERED 'HPL' FOLDING EDGE, RESIN WITH CLIMB FINISH OPZ. 1452

OPZ. 1452

GOLA E ZOCCOLO / FINGER RAIL AND PLINTH



ALLUMINIO FINITURA TITANIO OSSIDATO
ALUMINIUM TITANIUM OXIDIZED FINISH

OPZ. 414

SEDIA / CHAIR

GAMY

POLIPROPILENE TORTORA P 328
P 328 DOVE GREY POLYPROPYLENE



DIMENSIONI / DIMENSIONS

BASI - INTERPARETE - LIBRERIA / BASE UNITS - ROOM DIVIDER - BOOKCASE

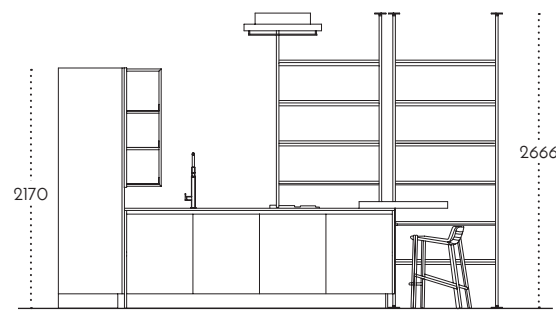

ISOLA - COLONNE / ISLAND - COLUMNS

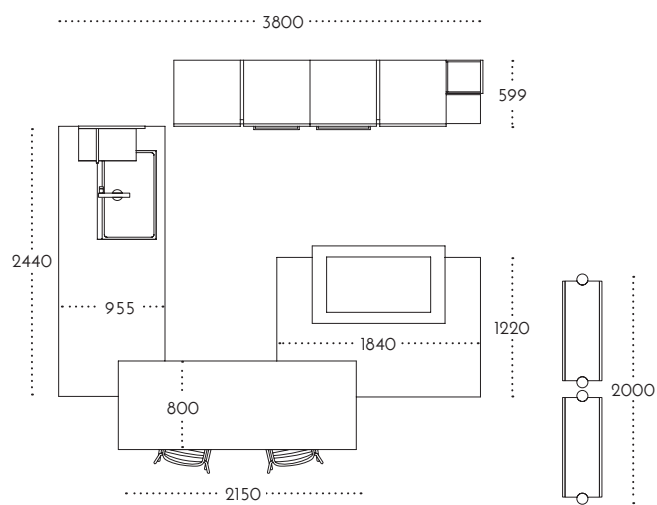
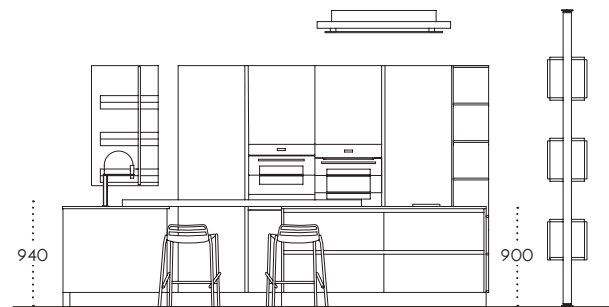

SEDIA E SGABELLO / CHAIR AND STOOL

SAW

METALLO VERNICIATO NERO FN
CUSCINI IN TESSUTO IMBOTTITO
PIX PEPE 29A

FN BLACK COATED METAL
PIX PEPPER 29A PADDED FABRIC CUSHIONS



FINITURE / FINISHES

ANTE / DOORS

OPZ. 5403



IMPIALLACCIATO SPAZZOLATO MATERICO CON NODO
ROVERE GRAFITE FIAMMA VERTICALE
BRUSHED VENEERED GRAPHITE OAK WITH VERTICAL GRAIN AND KNOTS,
TEXTURED FINISH

OPZ. LM14

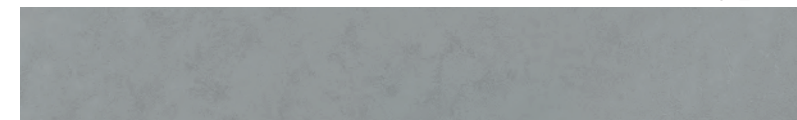

LACCATO OPACO FINITURA MALTA CON FONDO CEMENTO LIGHT GREY
MATT LACQUERED MORTAR FINISH WITH LIGHT GREY CEMENT SURFACE

TOP / WORKTOP

OPZ. LM14

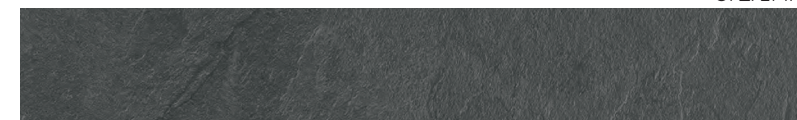

LAMINATO OLD BLACK FINITURA URBAN
OLD BLACK LAMINATE WITH URBAN FINISH

GOLA E ZOCCOLO / FINGER RAIL AND PLINTH

OPZ. 9533



GRIGIO BROMO
BROMINE GREY

OPZ. 9547



CENERE * opz 9547 cenere non disponibile
ASH

TAVOLO / TABLE

LEND

STRUTTURA NERO 08
PIANA IN VETRO
SATINATO NERO 7892

BLACK 08 STRUCTURE
SURFACE IN BLACK 7892 SATIN GLASS



DIMENSIONI / DIMENSIONS

ISOLA - COLONNE / ISLAND - COLUMNS

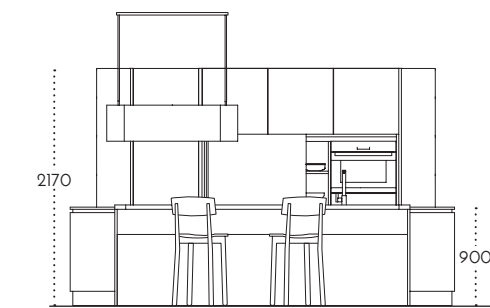

3158



3238

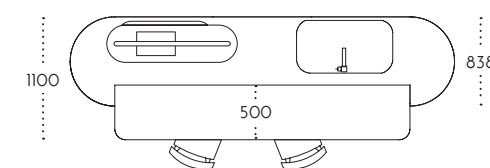

LIVING

2168

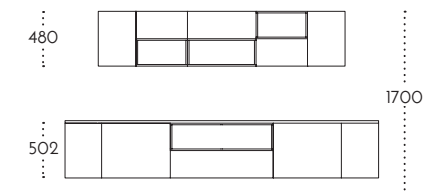

2768

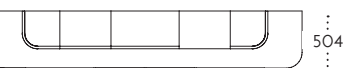

FINITURE / FINISHES

ANTE ED ELEMENTI A GIORNO / DOORS AND OPEN UNITS

OPZ. 9501



LACCATO OPACO GRIGIO KENIA
KENYA GREY MATT LACQUERED

OPZ. 9531



LACCATO OPACO FUMO
SMOKE MATT LACQUERED

ELEMENTI A GIORNO E PIANO SNACK /
OPEN UNITS AND SNACK BAR

OPZ. 5401



IMPIALLACCIATO SPAZZOLATO MATERICO CON NODO
ROVERE GRIGIO NEBBIA
BRUSHED VENEERED MIST GREY OAK WITH KNOTS, TEXTURED FINISH

TOP / WORKTOP



ACCIAIO INOX
STAINLESS STEEL

GOLA E ZOCCOLO / FINGER RAIL AND PLINTH

OPZ. 9531



FUMO
SMOKE

SGABELLO / STOOL

GERNIS

BASAMENTO CROMATO
SEDUTA E TELAIO TECNOPOLIMERO
NOCCIOLA 52-GRAFITE 21

CHROMED BASE
HAZELNUT 52 - GRAPHITE 21
TECHNO-POLYMER SEAT AND FRAME



DIMENSIONI / DIMENSIONS

ISOLA - COLONNE / ISLAND - COLUMNS

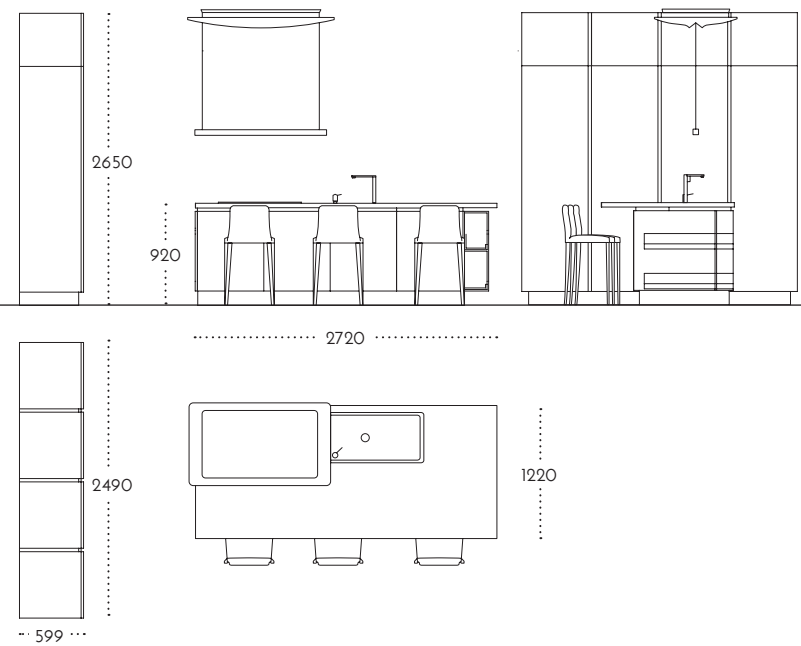

LIVING

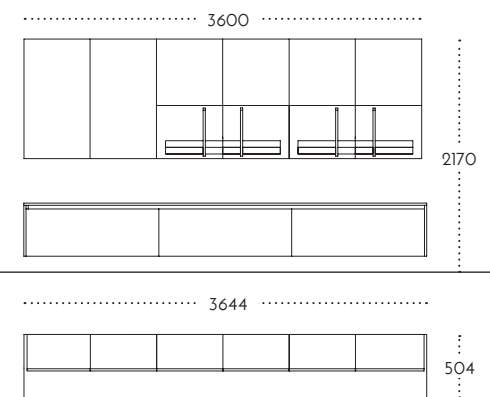

SEDIA E SGABELLO / CHAIR AND STOOL

BASAD

STRUTTURA METALLO
VERNICIATO FUMO
SCHIENALE E SEDUTA CUOIO
RIGENERATO FUMO D03
SMOKE-COATED METAL
STRUCTURE SMOKE
REGENERATED LEATHER BACKREST
AND SEAT D03



FINITURE / FINISHES

ANTE / DOORS

OPZ. V7402



VETRO LUCIDO BIANCO CALDO TELAIO ALLUMINIO OPACO IN TINTA
WARM WHITE GLOSSY GLASS WITH MATCHING ALUMINIUM FRAME MATT FINISH

OPZ. V8472



VETRO LUCIDO VERDE POSITANO TELAIO ALLUMINIO OPACO IN TINTA
POSITANO GREEN GLOSSY GLASS WITH MATCHING ALUMINIUM FRAME MATT FINISH

FIANCHI DI FINITURA / STRUCTURAL SIDES SAME FINISH AS DOOR

OPZ. 7401



LACCATO OPACO BIANCO CALDO
WARM WHITE MATT LACQUERED

TOP / WORKTOP

OPZ. 0032

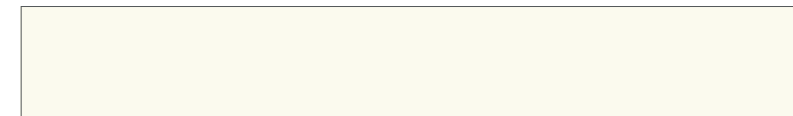

FENIX BIANCO CALDO PROFILO "PP"
WARM WHITE FENIX WITH "PP" PROFILE

OPZ. 0718



FENIX FUMO PROFILO "PP"
SMOKE FENIX WITH "PP" PROFILE

GOLA E ZOCCOLO / FINGER RAIL AND PLINTH

OPZ. 9531



FUMO
SMOKE

TAVOLO / TABLE

POK

PIANO IMPIALLACCIATO
ROVERE SPAZZOLATO
MATERICO CON NODO
GRIGIO NEBBIA OPZ. 5401,
STRUTTURA FUMO OPZ. FU
BRUSHED VENEERED MIST GREY
OAK WITH KNOTS
TEXTURED FINISH TOP OPZ. 5401,
SMOKE STRUCTURE OPT. FU



DIMENSIONI / DIMENSIONS

BASI - COLONNE / BASE UNITS - COLUMNS

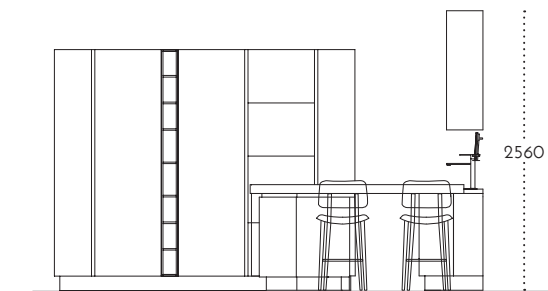

BASI - PENSILI / BASE UNITS - WALL UNITS

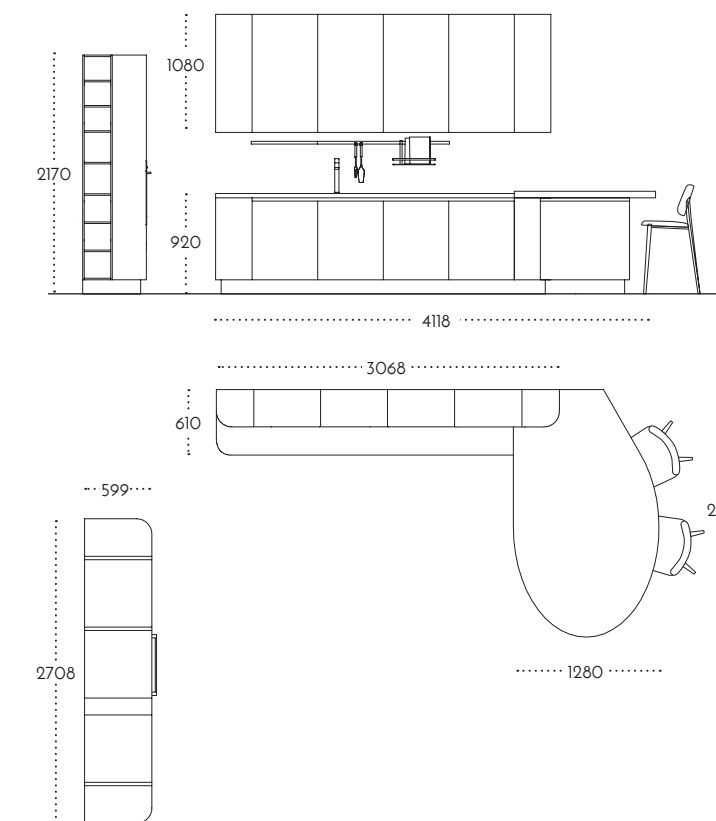

LIVING

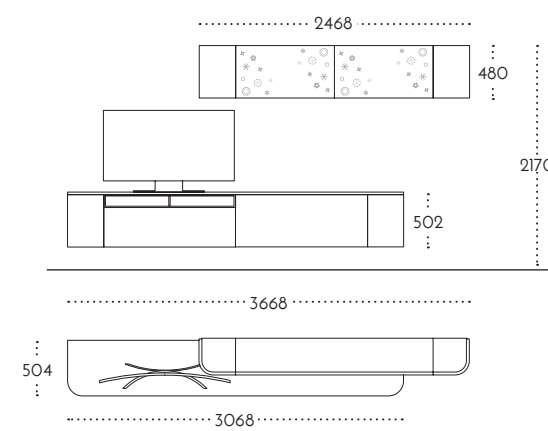

FINITURE / FINISHES

ANTE / DOORS

OPZ. 9533



LACCATO OPACO GRIGIO BROMO
BROMINE GREY MATT LACQUERED

OPZ. 741



LACCATO LUCIDO BIANCO ASSOLUTO
ABSOLUTE WHITE GLOSSY LACQUERED

*materiale non disponibile *OPZ. 740SD

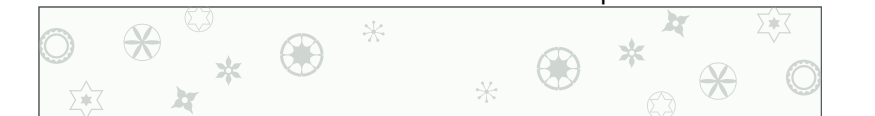

LACCATO BIANCO ASSOLUTO CON DECORO ASTRATTO A RILIEVO CENERE
ABSOLUTE WHITE LACQUERED WITH ASH ABSTRACT DECORATION IN RELIEF

TOP / WORKTOP

OPZ. 301



CORIAN GLACIER WHITE
GLACIER WHITE CORIAN

GOLA E ZOCCOLO / FINGER RAIL AND PLINTH

OPZ. 9533



GRIGIO BROMO
BROMINE GREY

SEDIA E SGABELLO / CHAIR AND STOOL

LIVIEN

STRUTTURA METALLO VERNICIATO
NERO F, SEDUTA E SCHIENALE
CUOIO RIGENERATO BIANCO Z05
BLACK-COATED F METAL STRUCTURE,
WHITE REGENERATED LEATHER SEAT
AND BACKREST Z05



TAVOLO / TABLE

POK

PIANO FENIX GRIGIO BROMO 0724
STRUTTURA NERO OPZ. NE
BROMINE GREY 0724 TOP
BLACK STRUCTURE OPT. NE



DIMENSIONI / DIMENSIONS

BASI - PENSILI / BASE UNITS - WALL UNITS

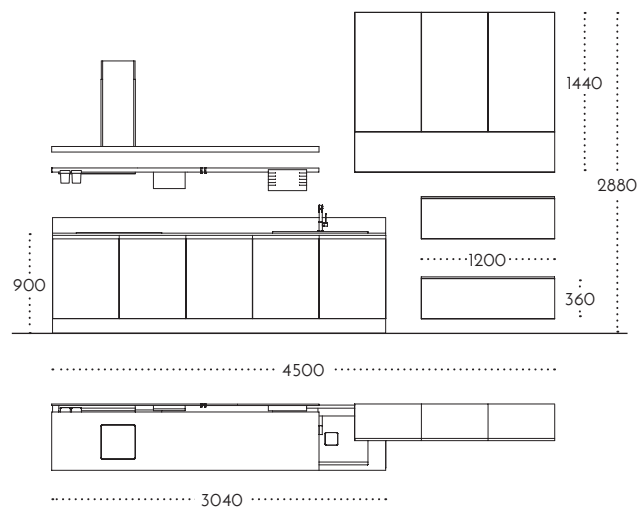

COLONNE / COLUMNS

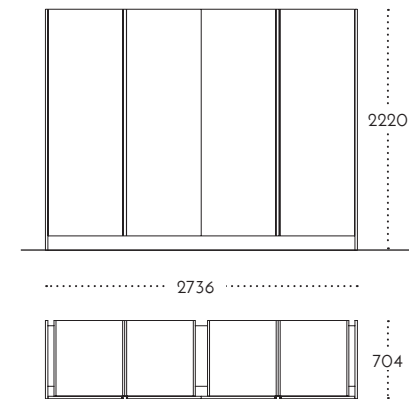

SEDIA / CHAIR

SPINDEL

SEDUTA POLIPROPILENE BIANCO PBN
STRUTTURA IN ROVERE NATURALE
POLYPROPYLENE WHITE PBN SEAT WITH
NATURAL OAK STRUCTURE



FINITURE / FINISHES

ANTE / DOORS



IMPIALLACCIATO SPAZZOLATO MATERICO CON NODO
ROVERE NATURALE FIAMMA VERTICALE
BRUSHED VENEERED NATURAL OAK WITH VERTICAL GRAIN AND KNOTS,
TEXTURED FINISH



LACCATO OPACO FINITURA MALTA CON FONDO CEMENTO WHITE
MATT LACQUERED MORTAR FINISH WITH WHITE CEMENT SURFACE



LACCATO BIANCO CALDO CON DECORO ASTRATTO A RILIEVO CASTORO
WARM WHITE LACQUERED WITH BEAVER ABSTRACT DECORATION IN RELIEF

TOP / WORKTOP



FENIX BIANCO CALDO PROFILO "PP"
WARM WHITE FENIX WITH "PP" PROFILE

GOLA E ZOCCOLO / FINGER RAIL AND PLINTH



ALLUMINIO FINITURA TITANIO OSSIDATO
ALUMINIUM TITANIUM OXIDIZED FINISH

TAVOLO / TABLE

KUSUT

STRUTTURA FUMO OPZ. FU
PIANO IMPIALLACCIATO
SPAZZOLATO MATERICO
CON NODO ROVERE NATURALE
OPZ. 5404

STRUCTURE SMOKE OPT. FU
BRUSHED VENEERED IN
NATURAL OAK WITH KNOTS
TEXTURED FINISH TOP OPT. 5404



DIMENSIONI / DIMENSIONS

BASI - PENSILI - COLONNE / BASE UNITS - WALL UNITS - COLUMNS

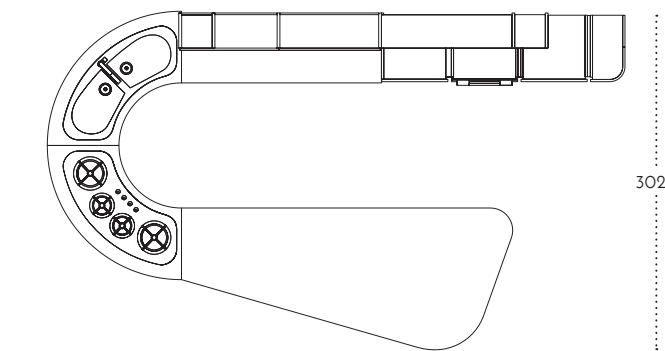
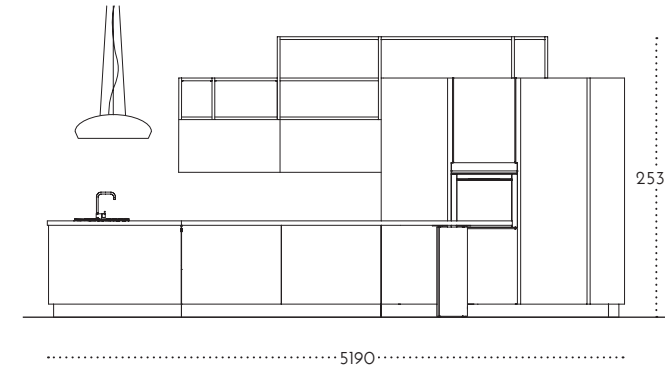

LIVING

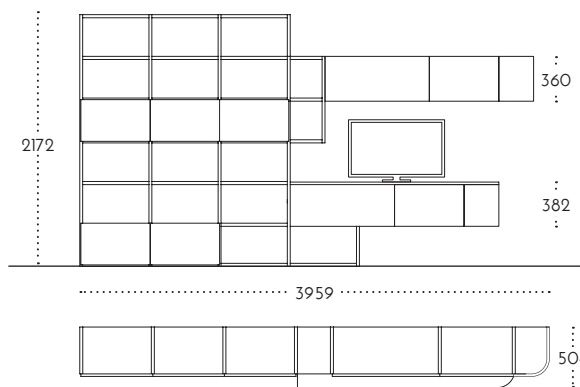

FINITURE / FINISHES

ANTE / DOORS



LACCATO LUCIDO FUMO
SMOKE GLOSSY LACQUERED

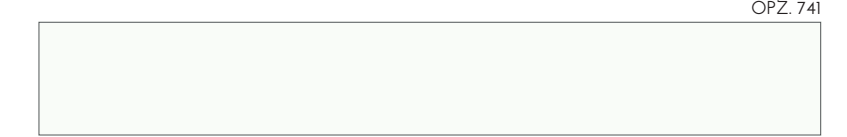

LACCATO LUCIDO BIANCO ASSOLUTO
ABSOLUTE WHITE GLOSSY LACQUERED

LIBRERIA / BOOKCASE



LACCATO OPACO FUMO
SMOKE MATT LACQUERED

TOP / WORKTOP



FENIX FUMO PROFILO "PP"
SMOKE FENIX WITH "PP" PROFILE

GOLA E ZOCCOLO / FINGER RAIL AND PLINTH



ALLUMINIO FINITURA BRILL
ALUMINIUM BRILL FINISH

SGABELLO / STOOL

KERE

STRUTTURA ROVERE SMOKE
SEDUTA SUGHERO SMOKE SGK
SMOKE OAK STRUCTURE
SMOKE CORK SGK SEAT



DIMENSIONI / DIMENSIONS

BASI - COLONNE / BASE UNITS - COLUMNS

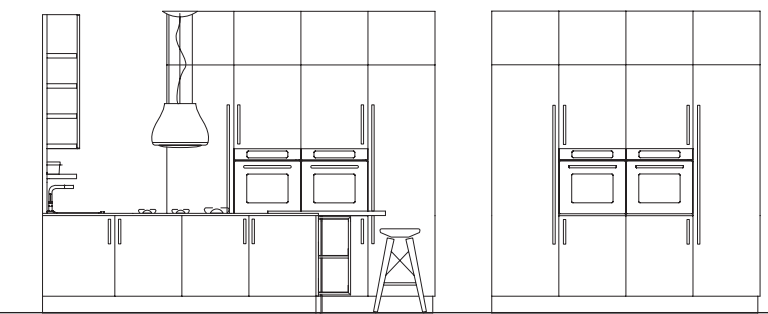

BASI - PENSILI VETRO / BASE UNITS - GLASS WALL UNITS

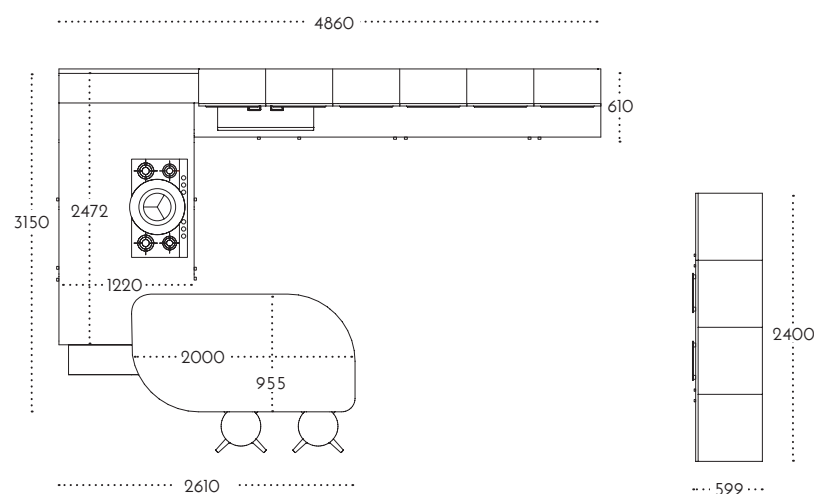
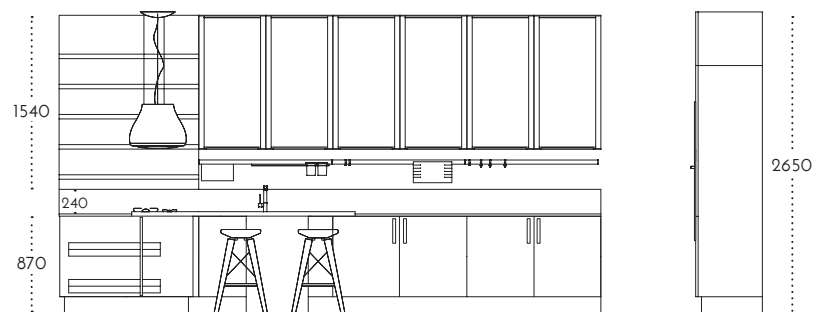

LIVING

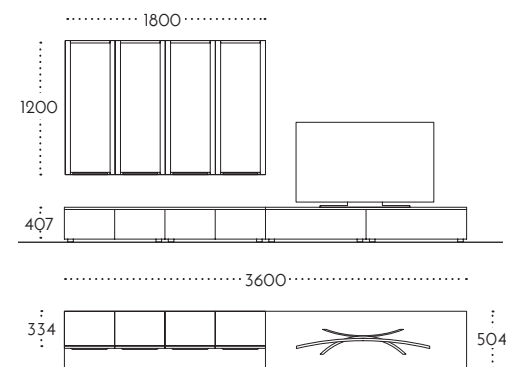

FINITURE / FINISHES

ANTE / DOORS

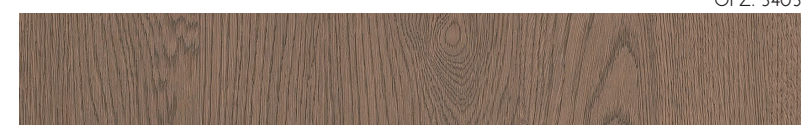

IMPIALLACCIATO SPAZZOLATO MATERICO CON NODO
ROVERE TABACCO FIAMMA VERTICALE
BRUSHED VENEERED TOBACCO OAK WITH VERTICAL GRAIN AND KNOTS,
TEXTURED FINISH



LACCATO OPACO FINITURA MALTA CON FONDO CEMENTO WHITE
MATT LACQUERED MORTAR FINISH WITH WHITE CEMENT SURFACE

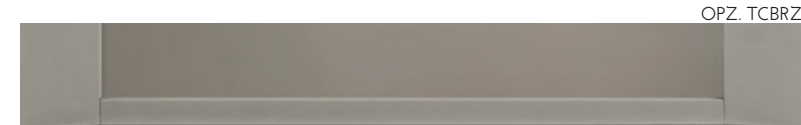

TELAIO ALLUMINIO TITANIO CON VETRO BRONZO
TITANIUM ALUMINIUM FRAME WITH BRONZE GLASS



LAMINATO OLD DARK FINITURA URBAN ABS 1
OLD DARK LAMINATE WITH URBAN FINISH ABS 1



ALLUMINIO FINITURA TITANIO OSSIDATO
ALUMINIUM TITANIUM OXIDIZED FINISH

SGABELLO / STOOL

KERE

STRUTTURA ROVERE SMOKE
SEDUTA SUGHERO SMOKE SGK
SMOKE OAK STRUCTURE
SMOKE CORK SGK SEAT



MANIGLIA / HANDLE

M.60

FINITURA TITANIO
TITANIUM FINISH



DIMENSIONI / DIMENSIONS

BASI - PENSILI / BASE UNITS - WALL UNITS

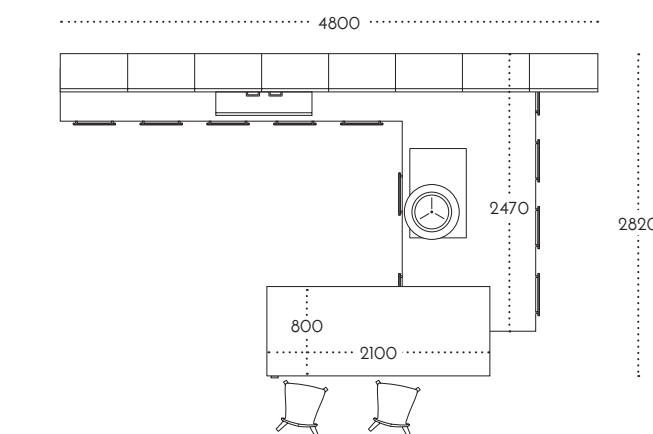
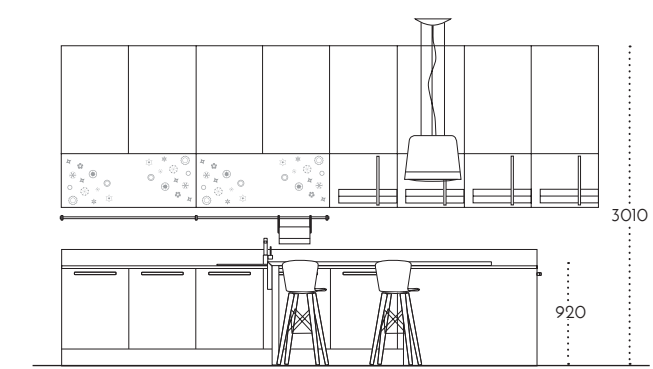

COLONNE / COLUMNS

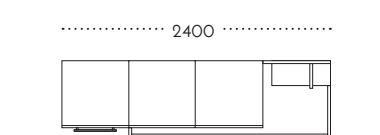
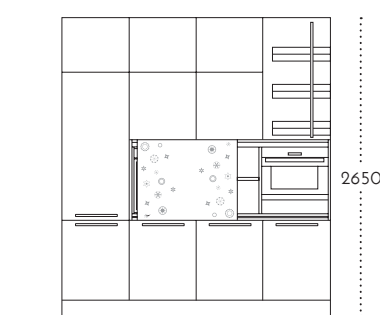

MOBILE LIVING LINEA "PLAN" /
"PLAN" LIVING CABINET

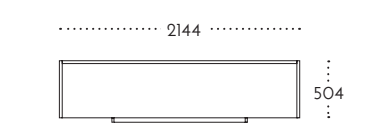
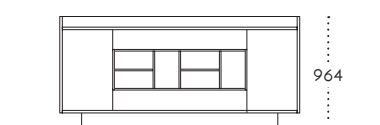

LIVING

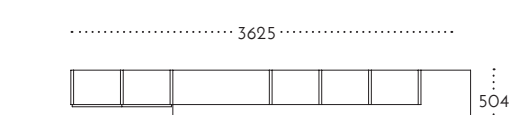
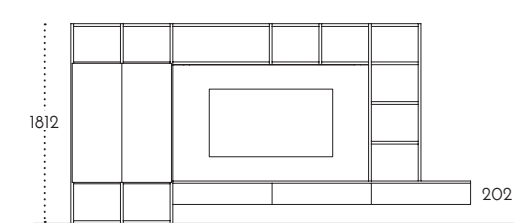

FINITURE / FINISHES

ANTE / DOORS



IMPIALLACCIATO SPAZZOLATO MATERICO CON NODO
ROVERE POLVERE FIAMMA VERTICALE
BRUSHED VENEERED DUST OAK WITH VERTICAL GRAIN AND KNOTS, TEXTURED FINISH



LACCATO FUMO CON DECORO ASTRATTO A RILIEVO CANAPA
SMOKE LACQUERED WITH HEMP ABSTRACT DECORATION IN RELIEF



LACCATO OPACO FINITURA MALTA CON FONDO CEMENTO BLACKBOARD
MATT LACQUERED MORTAR FINISH WITH BLACKBOARD CEMENT SURFACE

SCHIENALI SHELF / SHELF BACK PANELS



LACCATO OPACO FUMO / ALLUMINIO TITANIO
SMOKE MATT LACQUERED / ALUMINIUM TITANIUM FINISH

TOP / WORKTOP



LAMINATO OLD GREY FINITURA URBAN
OLD GREY LAMINATE WITH URBAN FINISH

ZOCCOLO / PLINTH



ALLUMINIO FINITURA TITANIO OSSIDATO
ALUMINIUM TITANIUM OXIDIZED FINISH

SGABELLO / STOOL

SPINDEL

SEDUTA POLIPROPILENE TORTORA PTR
STRUTTURA IN ROVERE SMOKE
POLYPROPYLENE DOVE GREY PTR SEAT WITH
SMOKE OAK STRUCTURE



MANIGLIA / HANDLE

583

FINITURA NICHEL SATINATO
SATIN NICKEL FINISH



DIMENSIONI / DIMENSIONS

BASI - PENSILI VETRO / BASE UNITS - GLASS WALL UNITS

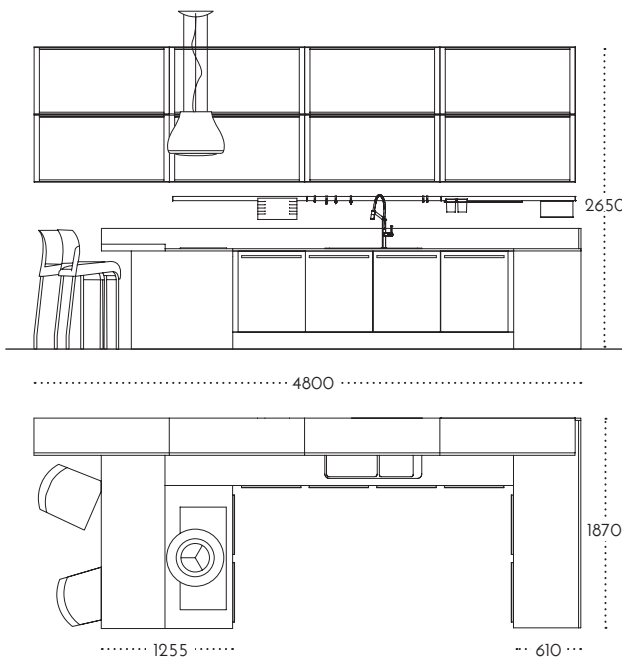

COLONNE / COLUMNS



VETRINA / SHOWCASE CABINET

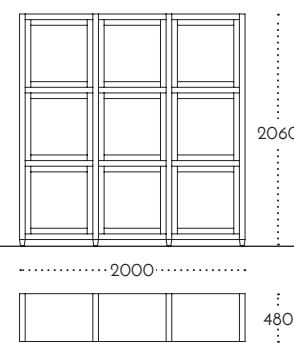

MOBILE LIVING LINEA "PLAN" / "PLAN" LIVING CABINET

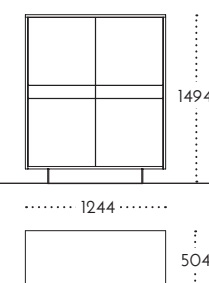

MANIGLIA / HANDLE

M.61

FINITURA NERO
BLACK FINISH



FINITURE / FINISHES

ANTE / DOORS

OPZ. 5410

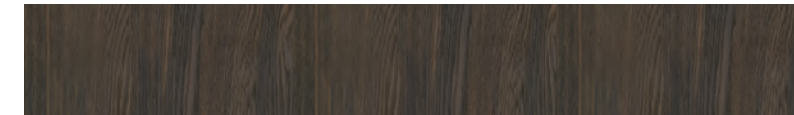

IMPIALLACCIATO PORO SEMIAPERTO SENZA NODO
ROVERE TERMOCOTTO FIAMMA VERTICALE
SEMI-OPEN PORE VENEERED THERMO-TREATED OAK VERTICAL GRAIN WITHOUT KNOTS
OPZ. LM12



LACCATO OPACO FINITURA MALTA CON FONDO CEMENTO DARK GREY
MATT LACQUERED MORTAR FINISH WITH DARK GREY CEMENT SURFACE
OPZ. NCSAT

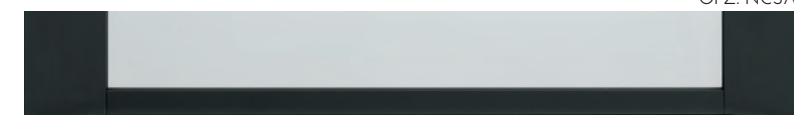

TELAIO ALLUMINIO NERO CON VETRO SATINATO
BLACK ALUMINIUM FRAME WITH SATIN GLASS

TOP / WORKTOP

OPZ. LM13



LAMINATO OLD DARK FINITURA URBAN
OLD DARK LAMINATE WITH URBAN FINISH

ZOCCOLO / PLINTH

OPZ. NU



ALLUMINIO FINITURA URBAN OSSIDATO
ALUMINIUM URBAN OXIDIZED FINISH

SGABELLO / STOOL

KETA

TECNOPOLIMERO
GRIGIO GRAFITE 21
GRAPHITE GREY
TECHNO-POLYMER 21



SEDIA / CHAIR

STILING

STRUTTURA IN METALLO,
RIVESTITA ECOPELLE TORTORA CLASSICO 7006
COATED METAL STRUCTURE, PADDED WITH
ECO-FRIENDLY LEATHER CLASSIC DOVE GREY 7006



TAVOLO / TABLE

INCLINE

STRUTTURA FUMO OPZ.FU
PIANO IMPIALLACCIATO PORO
SEMIAPERTO SENZA NODO
ROVERE TERMOCOTTO OPZ. 5410
SMOKE STRUCTURE OPT.FU
SEMI-OPEN PORE VENEERED THERMO-TREATED
OAK WITHOUT KNOTS OPT. 5410 TOP



DIMENSIONI / DIMENSIONS

BASI - PENSILI CON DECORO / BASE UNITS - WALL UNITS WITH DECORATION

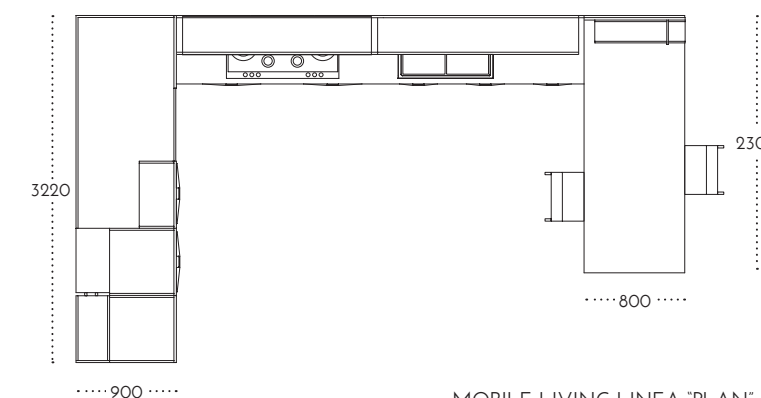
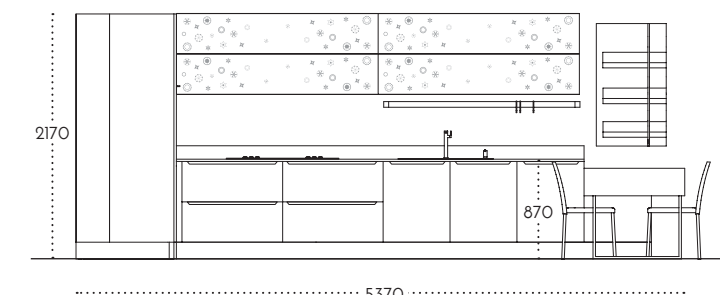

COLONNE / COLUMNS

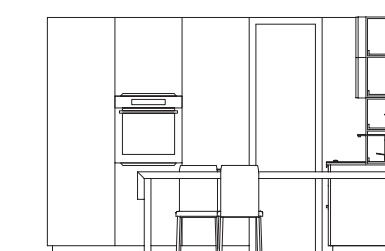

MOBILE LIVING LINEA "PLAN" -
PENSILI A GIORNO /
"PLAN" LIVING CABINET -
OPEN WALL UNITS

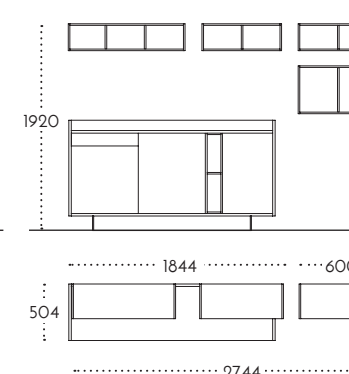

LIVING

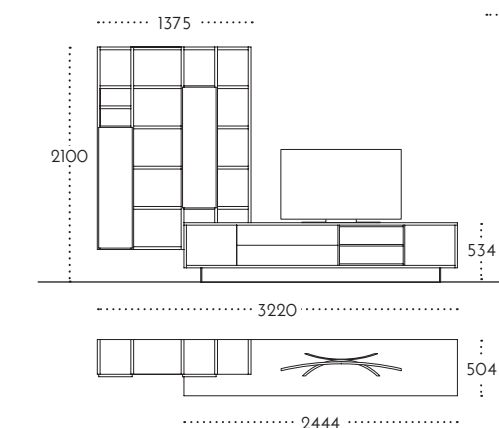

SEDIA / CHAIR

STILING

STRUTTURA IN METALLO,
RIVESTITA ECOPELLE TORTORA CLASSICO 7006
COATED METAL STRUCTURE, PADDED WITH
ECO-FRIENDLY LEATHER CLASSIC DOVE GREY 7006



FINITURE / FINISHES

ANTE / DOORS

OPZ. 1324



IMPIALLACCIATO PORO SEMIAPERTO SENZA NODO
NOCE CANALETTO FIAMMA VERTICALE
SEMI-OPEN PORE VENEERED CANALETTO WALNUT VERTICAL GRAIN WITHOUT KNOTS



LACCATO CANAPA CON DECORO ASTRATTO A RILIEVO CASTORO
HEMP LACQUERED WITH BEAVER ABSTRACT DECORATION IN RELIEF
OPZ. LM12



LACCATO OPACO FINITURA MALTA CON FONDO CEMENTO DARK GREY
MATT LACQUERED MORTAR FINISH WITH DARK GREY CEMENT SURFACE
OPZ. TCBRZ



TELAIO ALLUMINIO TITANIO CON VETRO BRONZO
TITANIUM ALUMINIUM FRAME WITH BRONZE GLASS

ELEMENTI A GIORNO / OPEN UNITS

OPZ. 8471



LACCATO OPACO VERDE POSITANO
POSITANO GREEN MATT LACQUERED
OPZ. 9531



LACCATO OPACO FUMO
SMOKE MATT LACQUERED

TOP / WORKTOP

OPZ. 5558



UNICOLOR CARNICO PROFILO "U3"
UNICOLOR CARNICO "U3" PROFILE

ZOCCOLO / PLINTH

OPZ. 414



ALLUMINIO FINITURA TITANIO OSSIDATO
ALUMINIUM TITANIUM OXIDIZED FINISH

MANIGLIA / HANDLE

H.52

FINITURA TITANIO
TITANIUM FINISH



DIMENSIONI / DIMENSIONS

BASI / BASE UNITS

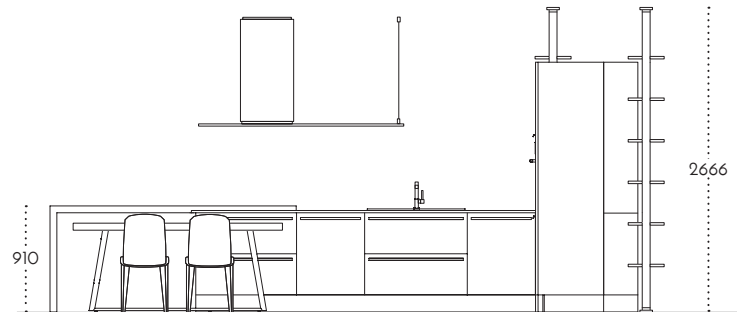

COLONNE - INTERPRETE / COLUMNS - ROOM DIVIDER

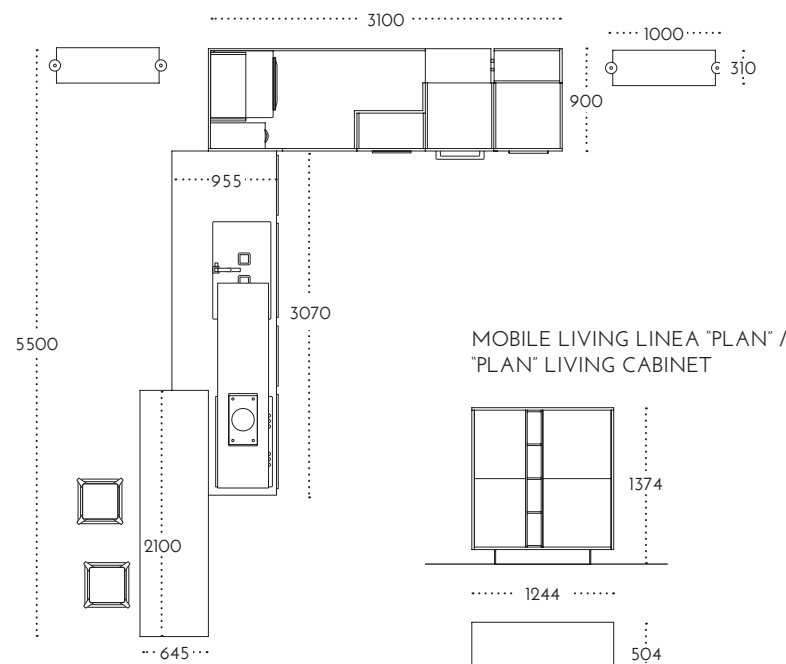
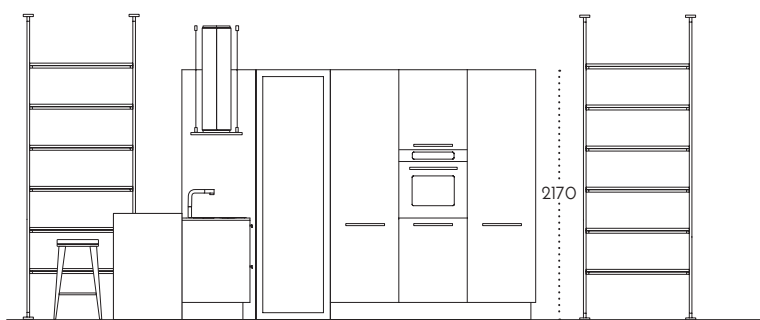

LIVING

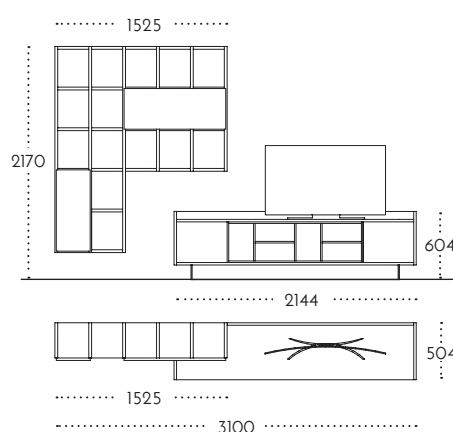

FINITURE / FINISHES

ANTE / DOORS



OPZ. 5403
 IMPIALLACCIATO SPAZZOLATO MATERICO CON NODO
 ROVERE GRAFITE FIAMMA VERTICALE
 BRUSHED VENEERED GRAPHITE OAK WITH VERTICAL GRAIN AND KNOTS,
 TEXTURED FINISH

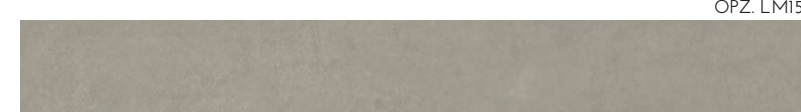

OPZ. LM15
 LACCATO OPACO FINITURA MALTA CON FONDO CEMENTO MINK
 MATT LACQUERED MORTAR FINISH WITH MINK CEMENT SURFACE



OPZ. NCSAT
 TELAIO ALLUMINIO NERO CON VETRO SATINATO
 BLACK ALUMINIUM FRAME WITH SATIN GLASS

ELEMENTI A GIORNO / OPEN UNITS

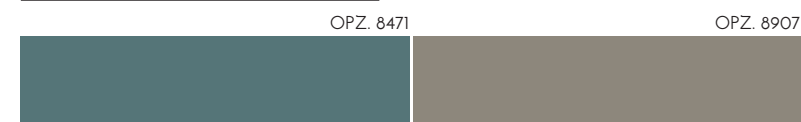

OPZ. 8471
 LACCATO OPACO VERDE POSITANO
 POSITANO GREEN MATT LACQUERED

OPZ. 8907
 LACCATO OPACO CASTORO
 BEAVER MATT LACQUERED

TOP / WORKTOP



OPZ. 0717
 FENIX CASTORO PROFILO "PP"
 BEAVER FENIX WITH "PP" PROFILE

ZOCCOLO / PLINTH



OPZ. NU
 ALLUMINIO FINITURA URBAN OSSIDATO
 ALUMINIUM URBAN OXIDIZED FINISH

SEDIA E SGABELLO / CHAIR AND STOOL

GHIM

STRUTTURA METALLO VERNICIATO
 GRIGIO ANTRACITE GAO
 SEDUTA SIMILPELLE BIANCO INCA 100
 ANTHRACITE GREY GAO COATED METAL STRUCTURE
 INCA 100 WHITE IN IMITATION LEATHER SEAT



TAVOLO / TABLE

POK

STRUTTURA METALLO VERNICIATO FERRO GREZZO OPZ. FG,
 PIANO IMPIALLACCIATO SPAZZOLATO
 MATERICO CON NODO
 ROVERE GRAFITE OPZ. 5403
 ROUGH IRON COATED METAL STRUCTURE OPT. FG,
 VENEERED TOP BRUSHED IN GRAPHITE OAK
 WITH KNOTS TEXTURED FINISH TOP OPT. 5403



MANIGLIA / HANDLE

M.60

FINITURA TITANIO
 TITANIUM FINISH



DIMENSIONI / DIMENSIONS

LIVING

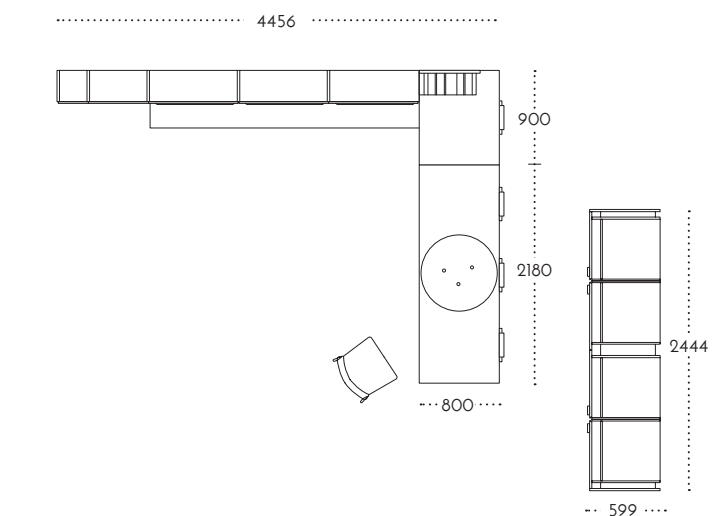
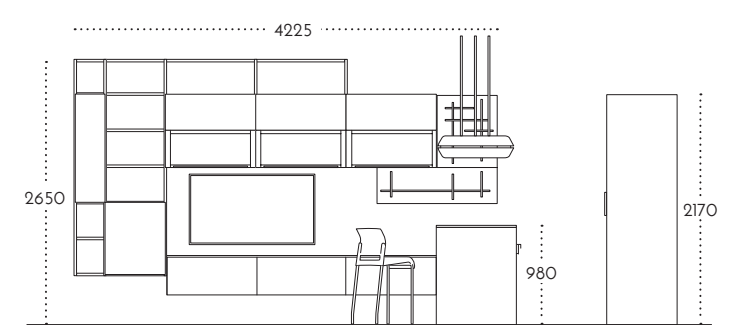

PENISOLA SCORREVOLE - COLONNE /
 SLIDING PENINSULA - COLUMNS

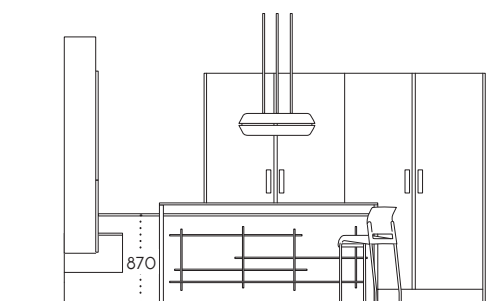

SEDIA E SGABELLO / CHAIR AND STOOL

KETA

TECNOPLIMERO
 GRIGIO GRAFITE 21
 GRAPHITE GREY
 TECHNO-POLYMER 21



FINITURE / FINISHES

ANTE / DOORS



OPZ. 5418
 IMPIALLACCIATO ROVERE LACCATO A PORO APERTO OPACO
 GRIGIO CENERE FIAMMA ORIZZONTALE
 OPEN PORE MATT LACQUERED ASH GREY OAK VENEERED WITH HORIZONTAL GRAIN
 OPZ. 9532



OPZ. TCBRZ
 LACCATO OPACO LUCIDO
 SMOKE GLOSSY LACQUERED

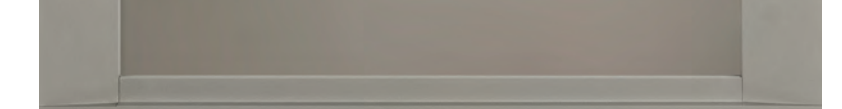

TELAIO ALLUMINIO TITANIO CON VETRO BRONZO
 TITANIUM ALUMINIUM FRAME WITH BRONZE GLASS

LIBRERIA / BOOKCASE



OPZ. 9531
 LACCATO OPACO FUMO
 SMOKE MATT LACQUERED

SCHIENALI WEAVE / WEAVE BACK PANELS



IMPIALLACCIATO ROVERE
 LACCATO A PORO APERTO OPACO
 GRIGIO CENERE FIAMMA ORIZZONTALE
 OPEN PORE MATT LACQUERED ASH GREY OAK
 VENEERED WITH HORIZONTAL GRAIN

OPZ. 9531
 MENSOLE
 LACCATO OPACO FUMO
 SHELVES
 SMOKE MATT LACQUERED

TOP / WORKTOP



OPZ. LM13
 LAMINATO OLD DARK FINITURA URBAN
 OLD DARK LAMINATE WITH URBAN FINISH

ZOCCOLO / PLINTH



OPZ. 9531
 FUMO
 SMOKE

MANIGLIA / HANDLE

952

FINITURA ANTRACITE
 ANTHRACITE FINISH



DIMENSIONI / DIMENSIONS

ISOLA SCORREVOLE - COLONNE / SLIDING ISLAND - COLUMNS

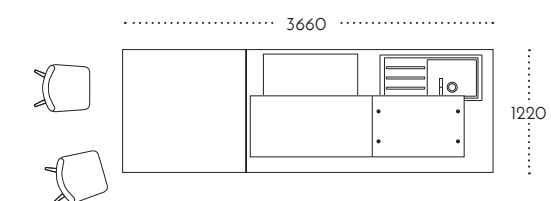
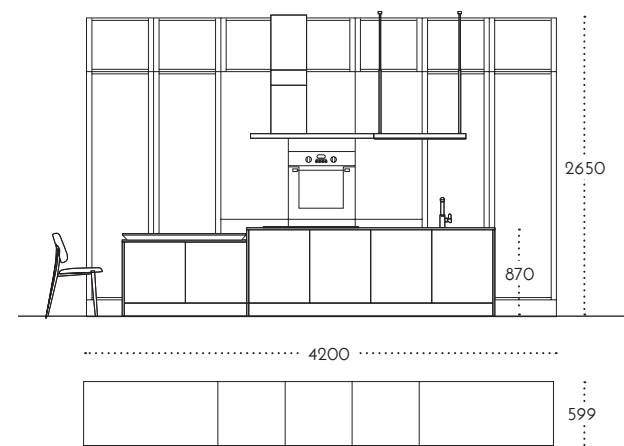

LIVING

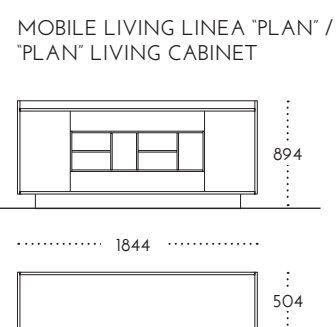
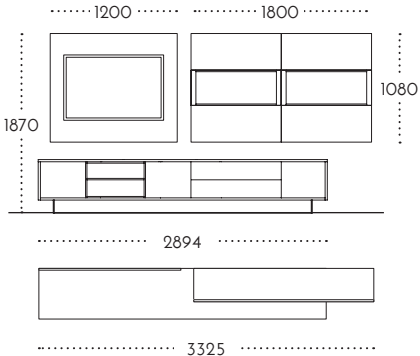

TAVOLO / TABLE

POK

TAVOLO FISSO OVALE
PIANO IMPIALLACCIATO LACCATO
A PORO APERTO OPACO
ROVERE GRIGIO CENERE 5418
STRUTTURA NERO OPZ. NE
OVAL NON EXTENDABLE TABLE
OPEN PORE MATT LACQUERED ASH
GREY OAK 5418 VENEERED
BLACK STRUCTURE OPT. NE



FINITURE / FINISHES

ANTE / DOORS

OPZ. G43B



GRES LAMINAM NERO FINITURA BLEND
TELAIO ALLUMINIO LACCATO OPACO BISTRO
BLEND FINISH BLACK GRES LAMINAM, BISTRO MATT LACQUERED ALUMINIUM FRAME

OPZ. TCBRZ



TELAIO ALLUMINIO TITANIO CON VETRO BRONZO
TITANIUM ALUMINIUM FRAME WITH BRONZE GLASS

PIANO PENISOLA / PENINSULA TOP

OPZ. LM11

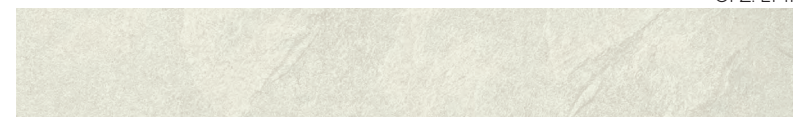

LAMINATO OLD WHITE FINITURA URBAN
OLD WHITE LAMINATE WITH URBAN FINISH

TOP / WORKTOP

OPZ. L933

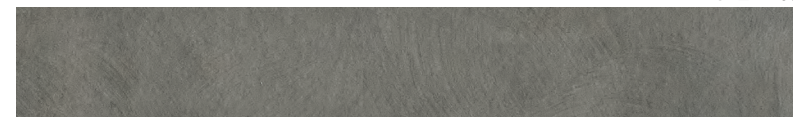

LAMINATO FERRO BORDO ABS 1
IRON LAMINATE ABS 1 EDGE

ZOCCOLO / PLINTH

OPZ. 414



ALLUMINIO FINITURA TITANIO OSSIDATO
ALUMINIUM TITANIUM OXIDIZED FINISH

LIVING ED ELEMENTI A GIORNO / LIVING AND OPEN UNITS

OPZ. 5418



IMPIALLACCIATO LACCATO A PORO APERTO OPACO
ROVERE GRIGIO CENERE FIAMMA ORIZZONTALE
OPEN PORE MATT LACQUERED ASH GREY OAK VENEERED WITH HORIZONTAL GRAIN

OPZ. 9533



LACCATO GRIGIO BROMO OPACO
BROMINE GREY MATT LACQUERED

SEDIA E SGABELLO / CHAIR AND STOOL

LIVIEN

STRUTTURA METALLO VERNICIATO
NERO F, SEDUTA E SCHIENALE
CUOIO RIGENERATO BIANCO Z05
BLACK-COATED METAL STRUCTURE F,
WHITE REGENERATED LEATHER SEAT
AND BACKREST Z05



DIMENSIONI / DIMENSIONS

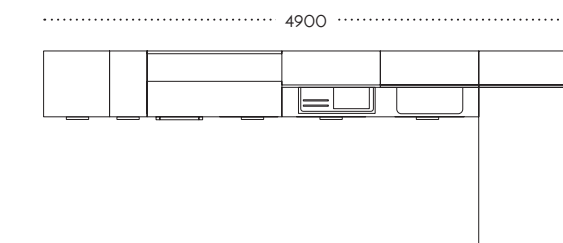
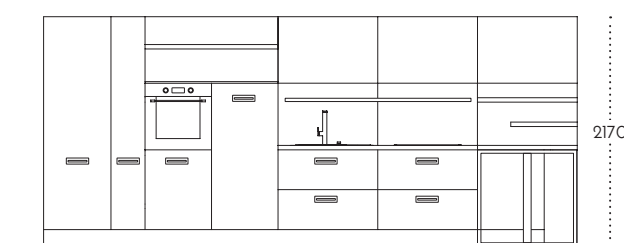

LIVING

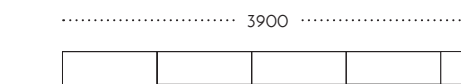
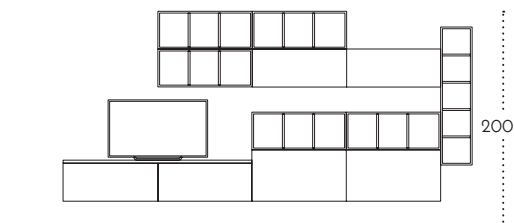

SGABELLO / STOOL

SPINDEL

SEDUTA POLIPROPILENE TORTORA PTR
STRUTTURA IN ROVERE NATURALE
POLYPROPYLENE DOVE GREY PTR SEAT WITH
NATURAL OAK STRUCTURE



FINITURE / FINISHES

ANTE ED ELEMENTI A GIORNO / DOORS AND OPEN UNITS

OPZ. 5404



IMPIALLACCIATO SPAZZOLATO MATERICO CON NODO
ROVERE NATURALE FIAMMA VERTICALE
BRUSHED VENEERED NATURAL OAK WITH VERTICAL GRAIN AND KNOTS,
TEXTURED FINISH

OPZ. 8908



LACCATO LUCIDO CASTORO
BEAVER GLOSSY LACQUERED

OPZ. 8907



LACCATO OPACO CASTORO
BEAVER MATT LACQUERED

OPZ. 8157



LACCATO OPACO ROSSO TOSCANO
TUSCAN RED MATT LACQUERED

TOP / WORKTOP

OPZ. 831

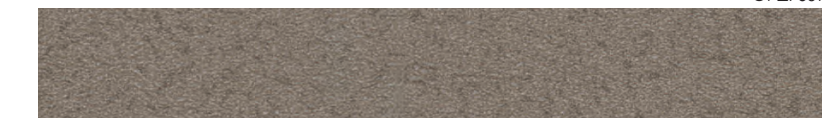

LAMINATO CAFFÈ FINITURA CRISTAL BORDO ABS 1
LAMINATE COFFEE CRISTAL FINISH ABS1 EDGE

ZOCCOLO / PLINTH

OPZ. 414



ALLUMINIO FINITURA TITANIO OSSIDATO
ALUMINIUM TITANIUM OXIDIZED FINISH

MANIGLIA / HANDLE

945T

FINITURA TITANIO
TITANIUM FINISH



DIMENSIONI / DIMENSIONS

BASI - PENSILI - LIBRERIA / BASE UNITS - WALL UNITS - BOOKCASE

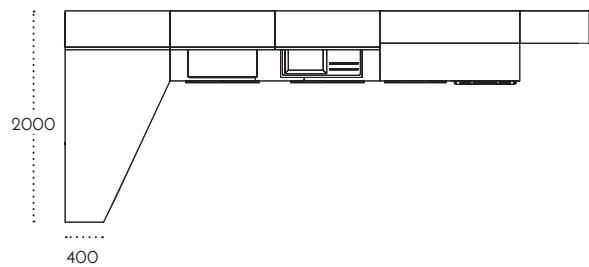
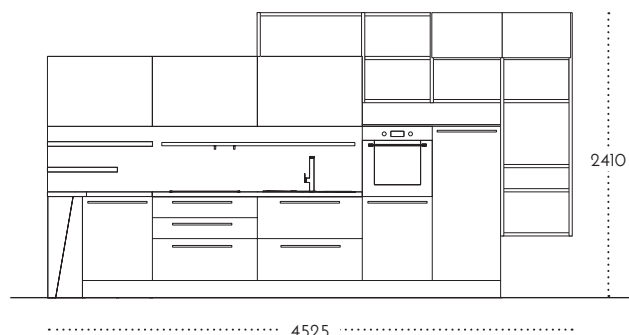

LIVING

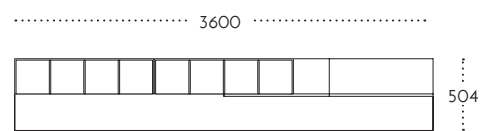
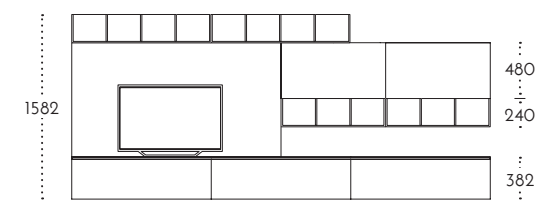

SGABELLO / STOOL

ZEDY

MASSELLO TINTO
ROVERE GRIGIO CENERE OPZ.5418
SOLID STAINED ASH GREY OAK OPT.5418



FINITURE / FINISHES

ANTE / DOORS

OPZ. 5402



IMPIALLACCIATO SPAZZOLATO MATERICO CON NODO
ROVERE POLVERE FIAMMA VERTICALE
BRUSHED VENEERED DUST OAK WITH VERTICAL GRAIN AND KNOTS, TEXTURED FINISH

OPZ. 9537



LACCATO OPACO GRIGIO PIOMBO
LEAD GREY MATT LACQUERED

OPZ. V9537



VETRO VERNICIATO SATINATO GRIGIO PIOMBO
TELAIO ALLUMINIO OPACO IN TINTA
LEAD GREY PAINTED SATIN GLASS WITH MATCHING ALUMINIUM FRAME MATT FINISH

OPZ. 8907



LACCATO OPACO CASTORO
BEAVER MATT LACQUERED

TOP / WORKTOP

OPZ. 0718



FENIX FUMO PROFILO "PP"
SMOKE FENIX WITH "PP" PROFILE

ZOCCOLO / PLINTH

OPZ. 9531

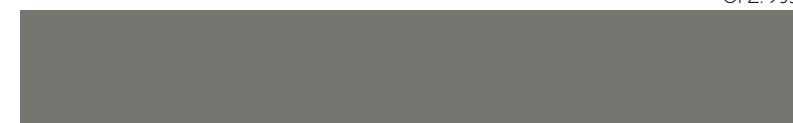

FUMO
SMOKE

MANIGLIA / HANDLE

M.50

FINITURA TITANIO
TITANIUM FINISH



DIMENSIONI / DIMENSIONS

ISOLA SCORREVOLE - COLONNE / SLIDING ISLAND - COLUMNS

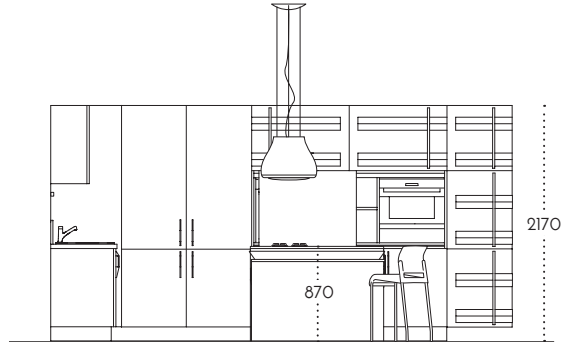

ISOLA - PENSILI / ISLAND - WALL UNITS

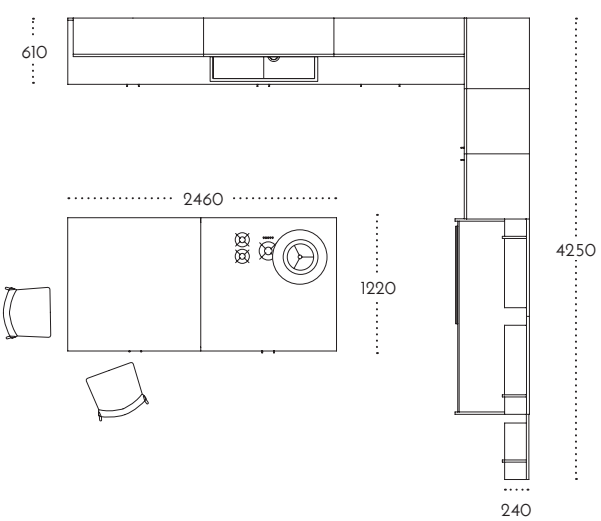
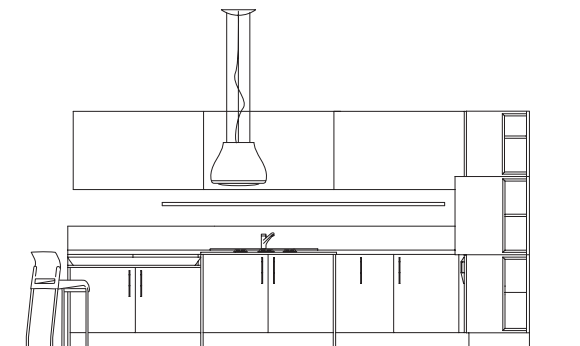

SEDIA / CHAIR

KETA

TECNOPOLIMERO
GRIGIO GRAFITE 21
GRAPHITE GREY 21
TECHNO-POLYMER



FINITURE / FINISHES

ANTE / DOORS

OPZ. 9506



LACCATO VINTAGE EFFETTO METALLO FERRO
VINTAGE LACQUERED METAL EFFECT, IRON COLOUR

OPZ. 5401



IMPIALLACCIATO SPAZZOLATO MATERICO CON NODO
ROVERE GRIGIO NEBBIA FIAMMA VERTICALE
BRUSHED VENEERED MIST GREY OAK WITH VERTICAL GRAIN AND KNOTS, TEXTURED FINISH

TOP / WORKTOP

OPZ. LM12

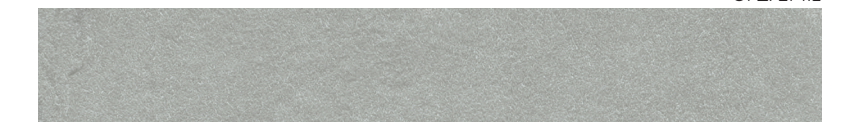

LAMINATO OLD GREY FINITURA URBAN
OLD GREY LAMINATE WITH URBAN FINISH

ZOCCOLO / PLINTH

OPZ. 414



ALLUMINIO FINITURA TITANIO OSSIDATO
ALUMINIUM TITANIUM OXIDIZED FINISH

MANIGLIA / HANDLE

M.50V

FINITURA TITANIO
TITANIUM FINISH



PROGETTO E COORDINAMENTO:
UFFICIO R&S: CARLO SACCHI, ARCH. EURO MARINUCCI
UFFICIO MKT: NADIA DEL PUPO
"LUBE SERVICE & ENGINEERING S.R.L."

ART DIRECTION, PROGETTO E GRAFICA: STUDIO FERRIANI

DIGITAL PHOTOGRAPHY: STUDIO FERRIANI

SELEZIONI : Z13
STAMPA: TIPOGRAFIA S.GIUSEPPE



LA LUBE INDUSTRIES SRL SI RISERVA LA FACOLTA' DI APPORTARE IN OGNI MOMENTO E SENZA PREAVVISO QUALSIASI MODIFICA TECNICA E CROMATICA RITENUTE UTILI AL MIGLIORAMENTO DEI PROPRI PRODOTTI.
I CAMPIONI E I COLORI RIPRODOTTI SONO PURAMENTE INDICATIVI.
LA RAPPRESENTAZIONE IN STAMPA PUO' ALTERARE LE TONALITA' DEI COLORI.

LUBE INDUSTRIES SRL RESERVES THE RIGHT TO MAKE AT ANY TIME AND WITHOUT PRIOR NOTICE ANY TECHNICAL AND COLOUR MODIFICATION DEEMED USEFUL FOR THE IMPROVEMENT OF ITS PRODUCTS.
THE SHOWN SAMPLES AND COLOURS ARE PURELY INDICATIVE.
PRINTED REPRESENTATION MAY ALTER THE ACTUAL COLOUR TONES.