



COMPLEMENTI

COMPLEMENTS

CUCINE
LUBE

GRUPPO LUBE

CREO
KITCHENS

Tower Hi-Line



Tower Hi-Line e' un sistema libreria con struttura in profili di alluminio.

Il sistema è stato progettato per avere un doppio utilizzo con fissaggio da pavimento a soffitto o a parete con piega superiore a 45°. Esiste inoltre un sistema di bloccaggio per consentire differenti tipi d'installazione su varie superfici.

Tower Hi-Line is a bookcase system with aluminum profile structure.

The system has been designed to have a double use: floor to ceiling or wall fixing, with a bend greater than 45°. There is also a locking system to allow different types of installation on various surfaces.



Tower Hi-Line a parete
è disponibile anche
con luce

The wall-leaning
Tower Hi-Line is also
available **with light.**



con luce with light



senza luce without light



Tower Hi-Line

con fissaggio a soffitto,
è disponibile in due
versioni:

- a parete
- ad isola

Tower Hi-Line

with ceiling fixing is
available in two versions:

- Wall-leaning
- Island







La flessibilità di **Tower Hi-Line** consente l'utilizzo del sistema in tutte le zone della casa a partire dalla cucina per passare alla zona soggiorno, alla zona notte ed al bagno.

Tramite l'utilizzo di due tipologie differenti di sistemi di aggancio, gli accessori che compongono **Tower Hi-Line** possono essere **mensole** in lamiera di **alluminio** lavorate di piega o mensole con profilo in alluminio e ripiano in vetro.

Tower Hi-Line si presta anche all'utilizzo di mensole o di accessori in **legno** tramite l'utilizzo dei sistemi di aggancio che possono essere venduti separatamente per dare una maggiore libertà di customizzazione al cliente.

The flexibility of **Tower Hi-Line** allows the use of the system in all areas of the house, from the kitchen to the living zone and the sleeping zone.

With two different types of systems for the hanging, the accessories that make up **Tower Hi-Line** can be folded **aluminum sheet shelves** or shelves with aluminum profile and glass shelf.

Tower Hi-Line is also suitable for the use of shelves or wooden accessories via the use of coupling systems, which can be sold separately, for offering to customer a greater possibility of customization.

Tower Hi-Line a parete retroilluminato led

LED backlit wall-leaning Tower Hi-Line

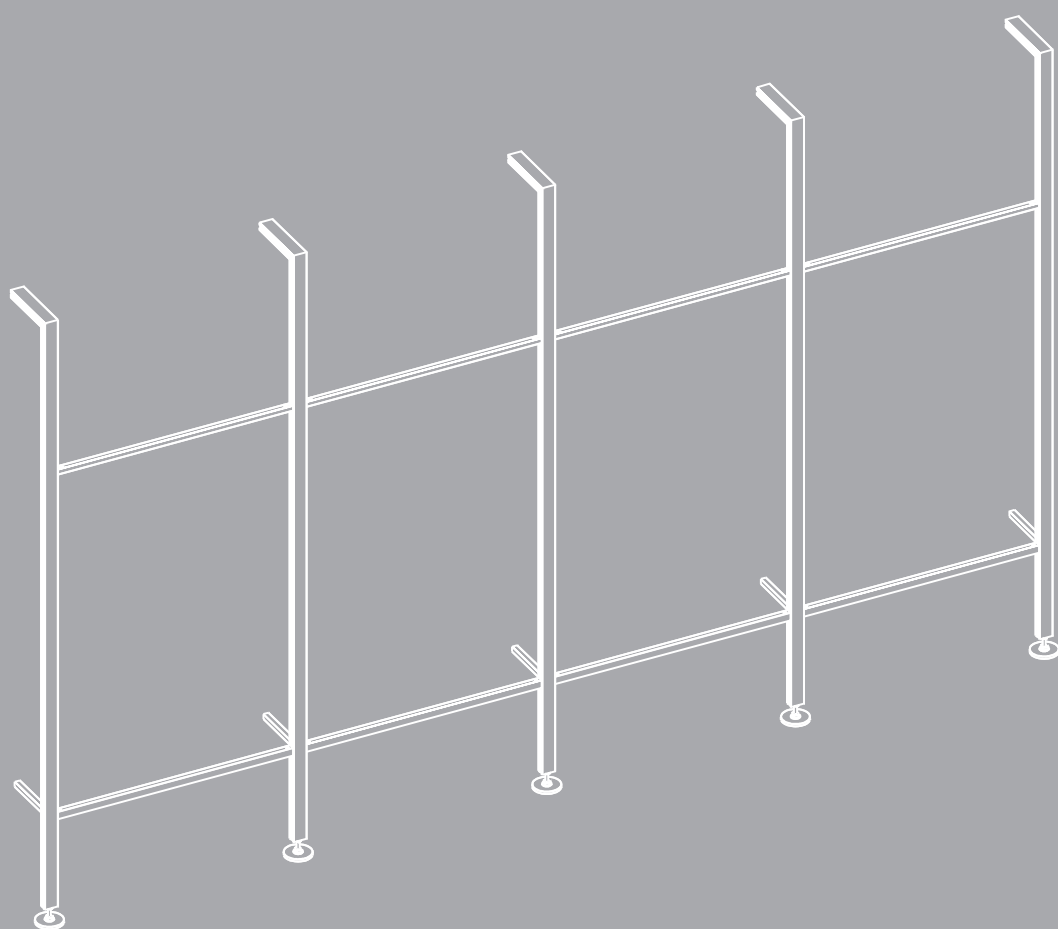

Tower Hi-Line a parete
Wall-leaning Tower Hi-Line

ILLUMINAZIONE LED A **UNA CAMPATA**, CON UN'USCITA CAVO ALIMENTAZIONE
SINGLE SPAN LED LIGHTING, WITH ONE POWER CABLE OUTPUT

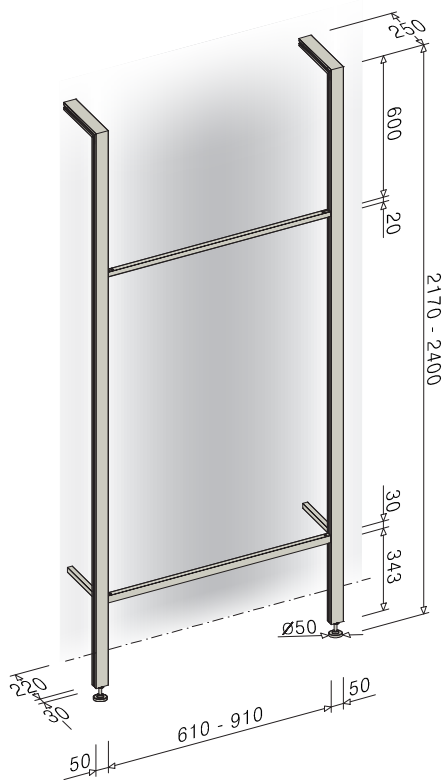

ALTEZZA E PROFONDITA' H.2170 P.250 MM
HEIGHT AND DEPTH H.2170 D.250 MM

		CODICE Code	
■ Nero	Black	L.71	08904TW10AL11
■ Titanio	Titanium	L.71	08904TW10AL12
■ Selce	Flint	L.71	08904TW10AL13
■ S.Dark	Dark Silver	L.71	08904TW10AL14
■ Nero	Black	L.101	08904TW12AL11
■ Titanio	Titanium	L.101	08904TW12AL12
■ Selce	Flint	L.101	08904TW12AL13
■ S.Dark	Dark Silver	L.101	08904TW12AL14

ALTEZZA E PROFONDITA' H.2400 P.250 MM
HEIGHT AND DEPTH H.2400 D.250 MM

		CODICE Code	
■ Nero	Black	L.71	08904TW11AL11
■ Titanio	Titanium	L.71	08904TW11AL12
■ Selce	Flint	L.71	08904TW11AL13
■ S.Dark	Dark Silver	L.71	08904TW11AL14
■ Nero	Black	L.101	08904TW13AL11
■ Titanio	Titanium	L.101	08904TW13AL12
■ Selce	Flint	L.101	08904TW13AL13
■ S.Dark	Dark Silver	L.101	08904TW13AL14

Tower Hi-Line a parete
Wall-leaning Tower Hi-Line

ILLUMINAZIONE LED A **DUE CAMPATE**, CON UN'USCITA CAVO ALIMENTAZIONE
TWO SPAN LED LIGHTING, WITH A POWER CABLE OUTPUT

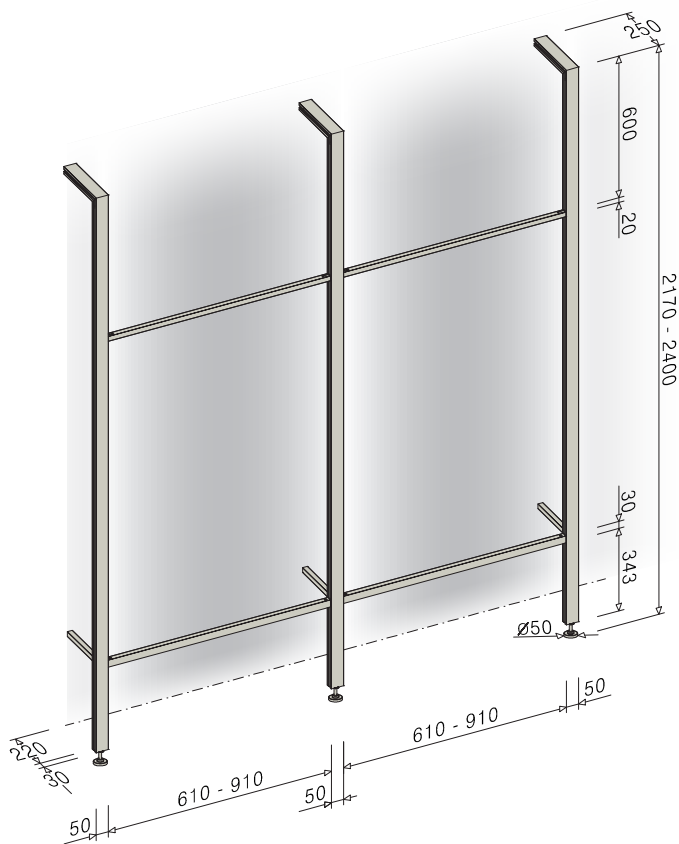

N.B.: In fase di ordine, indicare la campata in cui dovrà essere posizionata l'uscita del cavo alimentazione.

Note: When ordering, indicate the span in which the power cable outlet must be positioned.

ALTEZZA E PROFONDITA' H.2170 P.250 MM
HEIGHT AND DEPTH H.2170 D.250 MM

ALTEZZA E PROFONDITA' H.2400 P.250 MM
HEIGHT AND DEPTH H.2400 D.250 MM

		CODICE Code	
■ Nero	Black	L.137	08904TW20AL11
■ Titanio	Titanium	L.137	08904TW20AL12
■ Selce	Flint	L.137	08904TW20AL13
■ S.Dark	Dark Silver	L.137	08904TW20AL14
■ Nero	Black	L.167	08904TW22AL11
■ Titanio	Titanium	L.167	08904TW22AL12
■ Selce	Flint	L.167	08904TW22AL13
■ S.Dark	Dark Silver	L.167	08904TW22AL14
■ Nero	Black	L.197	08904TW24AL11
■ Titanio	Titanium	L.197	08904TW24AL12
■ Selce	Flint	L.197	08904TW24AL13
■ S.Dark	Dark Silver	L.197	08904TW24AL14

		CODICE Code	
■ Nero	Black	L.137	08904TW21AL11
■ Titanio	Titanium	L.137	08904TW21AL12
■ Selce	Flint	L.137	08904TW21AL13
■ S.Dark	Dark Silver	L.137	08904TW21AL14
■ Nero	Black	L.167	08904TW23AL11
■ Titanio	Titanium	L.167	08904TW23AL12
■ Selce	Flint	L.167	08904TW23AL13
■ S.Dark	Dark Silver	L.167	08904TW23AL14
■ Nero	Black	L.197	08904TW25AL11
■ Titanio	Titanium	L.197	08904TW25AL12
■ Selce	Flint	L.197	08904TW25AL13
■ S.Dark	Dark Silver	L.197	08904TW25AL14

Tower Hi-Line a parete
Wall-leaning Tower Hi-Line

ILLUMINAZIONE LED A TRE CAMPATE, CON DUE USCITE CAVO ALIMENTAZIONE
THREE SPAN LED LIGHTING, WITH TWO POWER CABLE OUTPUT

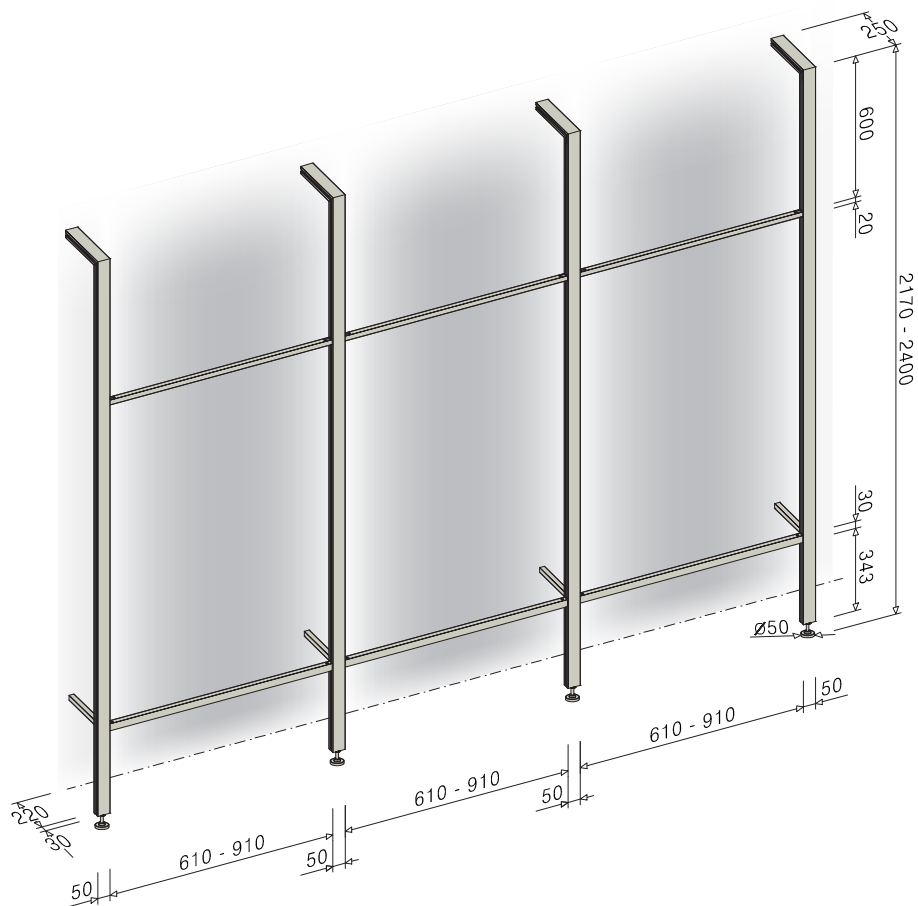

N.B.: In fase di ordine, indicare la due campate in cui dovranno essere posizionate le uscite del cavo alimentazione.

Note: When ordering, indicate the two spans in which the power cable outlet must be positioned.

ALTEZZA E PROFONDITA' H.2170 P.250 MM
HEIGHT AND DEPTH H.2170 D.250 MM

ALTEZZA E PROFONDITA' H.2400 P.250 MM
HEIGHT AND DEPTH H.2400 D.250 MM

		CODICE Code	
■ Nero	Black	L.203	08904TW30AL11
■ Titanio	Titanium	L.203	08904TW30AL12
■ Selce	Flint	L.203	08904TW30AL13
■ S.Dark	Dark Silver	L.203	08904TW30AL14
■ Nero	Black	L.233	08904TW32AL11
■ Titanio	Titanium	L.233	08904TW32AL12
■ Selce	Flint	L.233	08904TW32AL13
■ S.Dark	Dark Silver	L.233	08904TW32AL14
■ Nero	Black	L.263	08904TW34AL11
■ Titanio	Titanium	L.263	08904TW34AL12
■ Selce	Flint	L.263	08904TW34AL13
■ S.Dark	Dark Silver	L.263	08904TW34AL14
■ Nero	Black	L.293	08904TW36AL11
■ Titanio	Titanium	L.293	08904TW36AL12
■ Selce	Flint	L.293	08904TW36AL13
■ S.Dark	Dark Silver	L.293	08904TW36AL14

		CODICE Code	
■ Nero	Black	L.203	08904TW31AL11
■ Titanio	Titanium	L.203	08904TW31AL12
■ Selce	Flint	L.203	08904TW31AL13
■ S.Dark	Dark Silver	L.203	08904TW31AL14
■ Nero	Black	L.233	08904TW33AL11
■ Titanio	Titanium	L.233	08904TW33AL12
■ Selce	Flint	L.233	08904TW33AL13
■ S.Dark	Dark Silver	L.233	08904TW33AL14
■ Nero	Black	L.263	08904TW35AL11
■ Titanio	Titanium	L.263	08904TW35AL12
■ Selce	Flint	L.263	08904TW35AL13
■ S.Dark	Dark Silver	L.263	08904TW35AL14
■ Nero	Black	L.293	08904TW37AL11
■ Titanio	Titanium	L.293	08904TW37AL12
■ Selce	Flint	L.293	08904TW37AL13
■ S.Dark	Dark Silver	L.293	08904TW37AL14

Tower Hi-Line a parete
Wall-leaning Tower Hi-Line

ILLUMINAZIONE LED A QUATTRO CAMPATE, CON DUE USCITE CAVO ALIMENTAZIONE
FOUR SPAN LED LIGHTING, WITH TWO POWER CABLE OUTPUTS

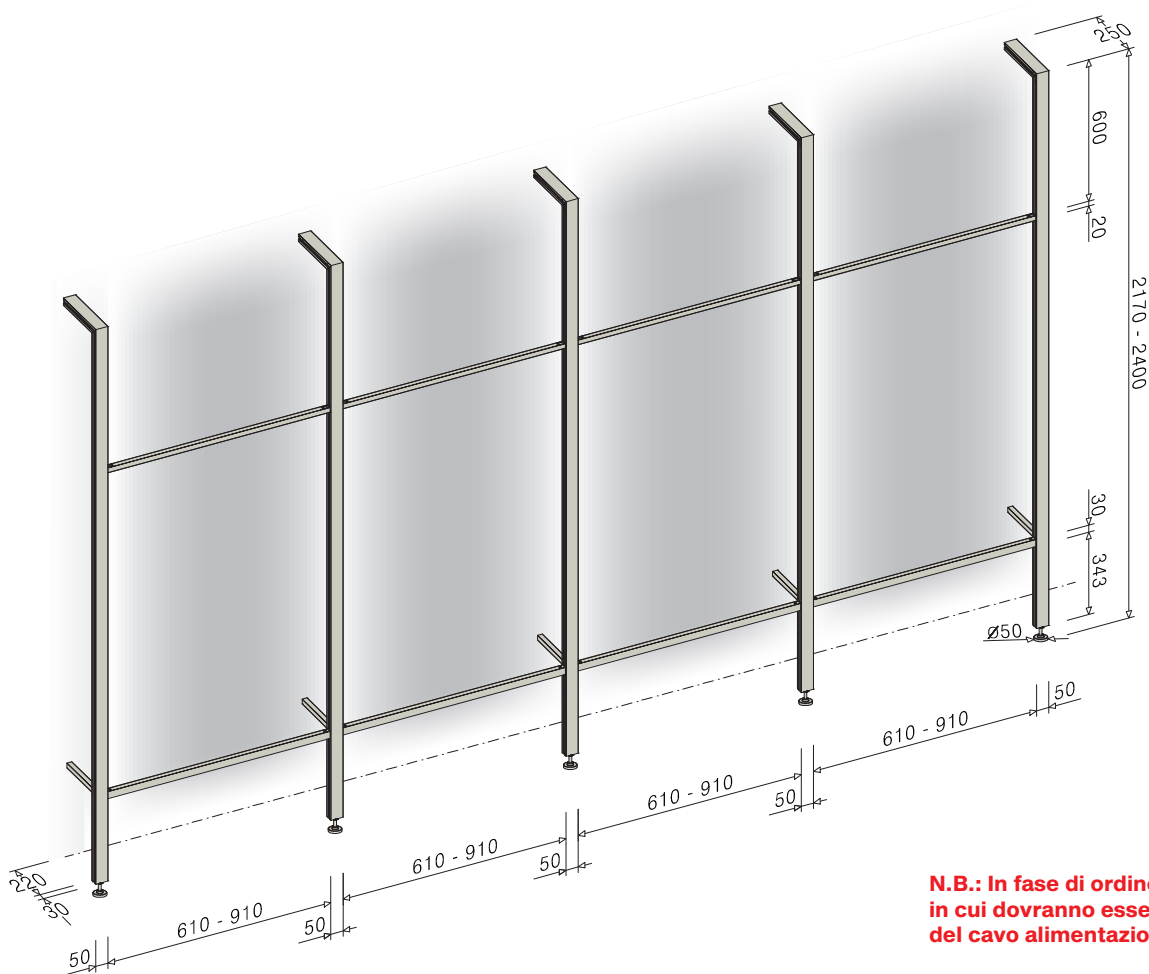

N.B.: In fase di ordine, indicare la due campate in cui dovranno essere posizionate le uscite del cavo alimentazione.

Note: When ordering, indicate the two spans in which the power cable outlet must be positioned.

ALTEZZA E PROFONDITA' H.2170 P.250 MM
HEIGHT AND DEPTH H.2170 D.250 MM

ALTEZZA E PROFONDITA' H.2400 P.250 MM
HEIGHT AND DEPTH H.2400 D.250 MM

		CODICE Code	
■ Nero	Black	L.269	08904TW40AL11
■ Titanio	Titanium	L.269	08904TW40AL12
■ Selce	Flint	L.269	08904TW40AL13
■ S.Dark	Dark Silver	L.269	08904TW40AL14
■ Nero	Black	L.299	08904TW42AL11
■ Titanio	Titanium	L.299	08904TW42AL12
■ Selce	Flint	L.299	08904TW42AL13
■ S.Dark	Dark Silver	L.299	08904TW42AL14
■ Nero	Black	L.329	08904TW44AL11
■ Titanio	Titanium	L.329	08904TW44AL12
■ Selce	Flint	L.329	08904TW44AL13
■ S.Dark	Dark Silver	L.329	08904TW44AL14
■ Nero	Black	L.359	08904TW46AL11
■ Titanio	Titanium	L.359	08904TW46AL12
■ Selce	Flint	L.359	08904TW46AL13
■ S.Dark	Dark Silver	L.359	08904TW46AL14
■ Nero	Black	L.389	08904TW48AL11
■ Titanio	Titanium	L.389	08904TW48AL12
■ Selce	Flint	L.389	08904TW48AL13
■ S.Dark	Dark Silver	L.389	08904TW48AL14

		CODICE Code	
■ Nero	Black	L.269	08904TW41AL11
■ Titanio	Titanium	L.269	08904TW41AL12
■ Selce	Flint	L.269	08904TW41AL13
■ S.Dark	Dark Silver	L.269	08904TW41AL14
■ Nero	Black	L.299	08904TW43AL11
■ Titanio	Titanium	L.299	08904TW43AL12
■ Selce	Flint	L.299	08904TW43AL13
■ S.Dark	Dark Silver	L.299	08904TW43AL14
■ Nero	Black	L.329	08904TW45AL11
■ Titanio	Titanium	L.329	08904TW45AL12
■ Selce	Flint	L.329	08904TW45AL13
■ S.Dark	Dark Silver	L.329	08904TW45AL14
■ Nero	Black	L.359	08904TW47AL11
■ Titanio	Titanium	L.359	08904TW47AL12
■ Selce	Flint	L.359	08904TW47AL13
■ S.Dark	Dark Silver	L.359	08904TW47AL14
■ Nero	Black	L.389	08904TW49AL11
■ Titanio	Titanium	L.389	08904TW49AL12
■ Selce	Flint	L.389	08904TW49AL13
■ S.Dark	Dark Silver	L.389	08904TW49AL14

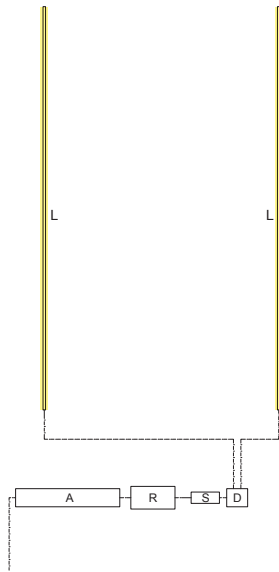

ESEMPIO SCHEMA DI ALIMENTAZIONE UNA CAMPATA
EXAMPLE OF POWER SUPPLY DIAGRAM ONE SPAN

A	n°1	Driver 100w ul	Driver 100w ul
D	n°1	Distributore 4 uscite	4-way distributor
L	n°2	Led dual color	Led dual color
R	n°1	Dimmer c/radiocom.	Dimmer with remote control
S	n°1	Selezionatore	Selector

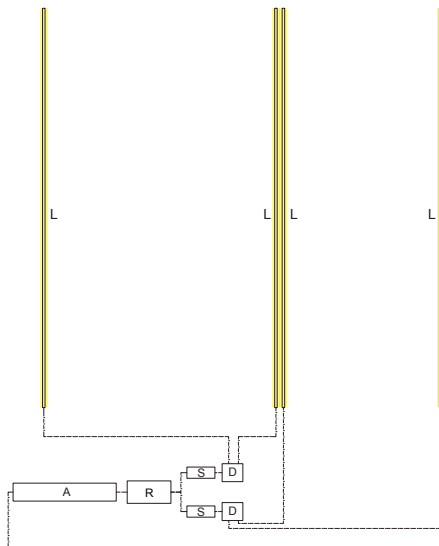

ESEMPIO SCHEMA DI ALIMENTAZIONE DUE CAMPATE
EXAMPLE OF POWER SUPPLY DIAGRAM TWO SPANS

A	n°1	Driver 100w ul	Driver 100w ul
D	n°2	Distributore 4 uscite	4-way distributor
L	n°4	Led dual color	Led dual color
R	n°1	Dimmer c/radiocom.	Dimmer with remote control
S	n°2	Selezionatore	Selector

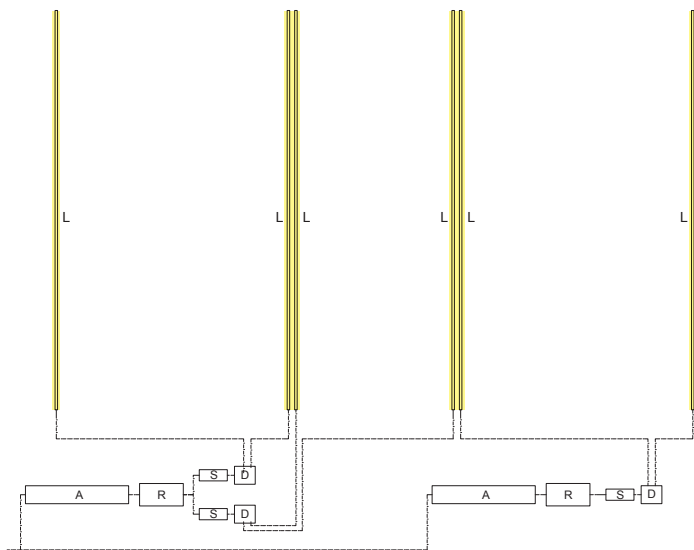

ESEMPIO SCHEMA DI ALIMENTAZIONE A TRE CAMPATE
EXAMPLE OF POWER SUPPLY DIAGRAM THREE SPANS

A	n°2	Driver 100w ul	Driver 100w ul
D	n°3	Distributore 4 uscite	4-way distributor
L	n°6	Led dual color	Led dual color
R	n°2	Dimmer c/radiocom.	Dimmer with remote control
S	n°3	Selezionatore	Selector

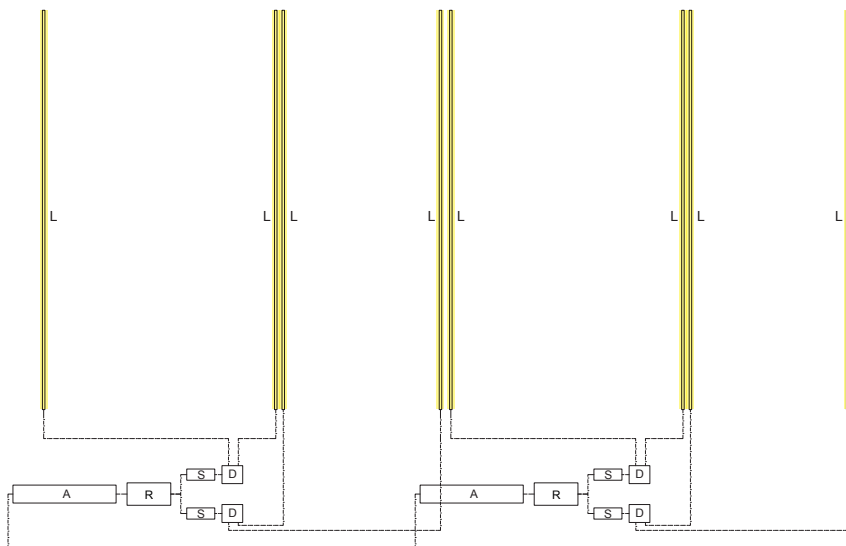

ESEMPIO SCHEMA DI ALIMENTAZIONE QUATTRO CAMPATE
EXAMPLE OF POWER SUPPLY DIAGRAM FOUR SPANS

A	n°2	Driver 100w ul	Driver 100w ul
D	n°4	Distributore 4 uscite	4-way distributor
L	n°8	Led dual color	Led dual color
R	n°2	Dimmer c/radiocom.	Dimmer with remote control
S	n°4	Selezionatore	Selector

Tower Hi-Line a parete

Wall-leaning Tower Hi-Line

Senza illuminazione
Without lighting

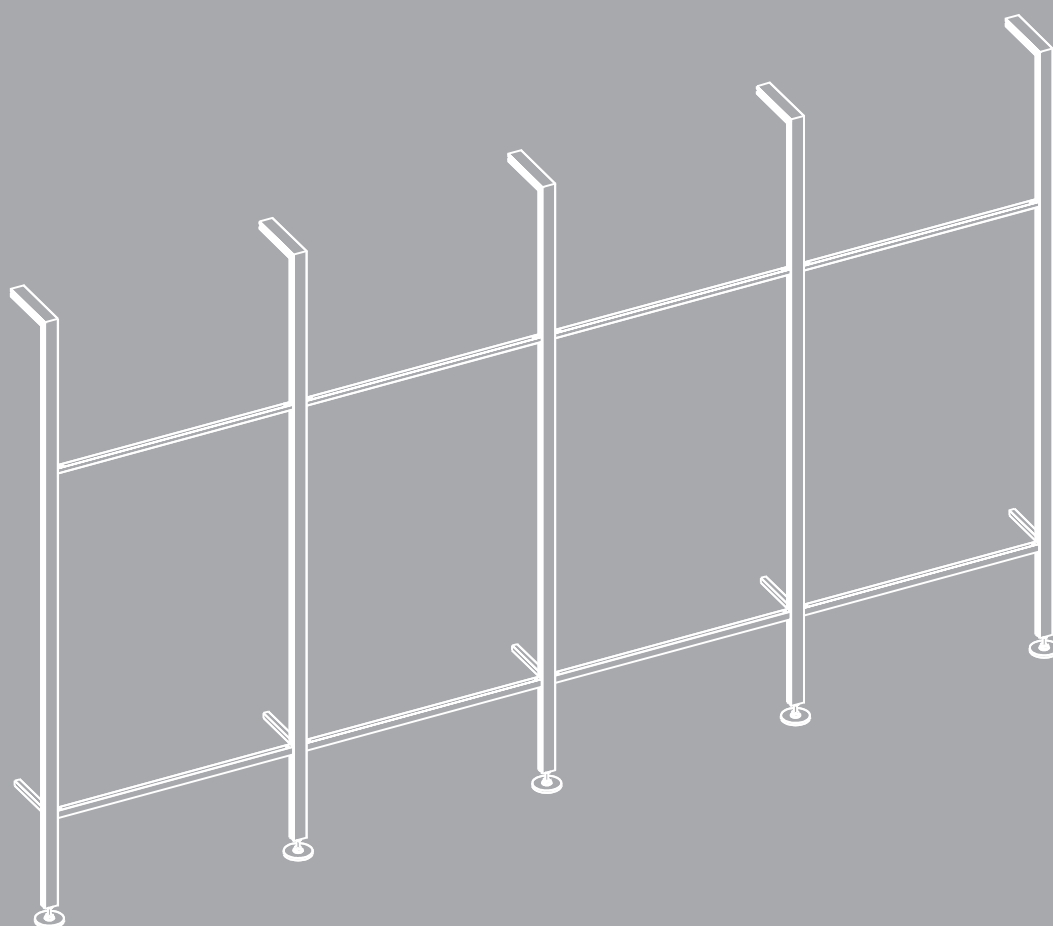

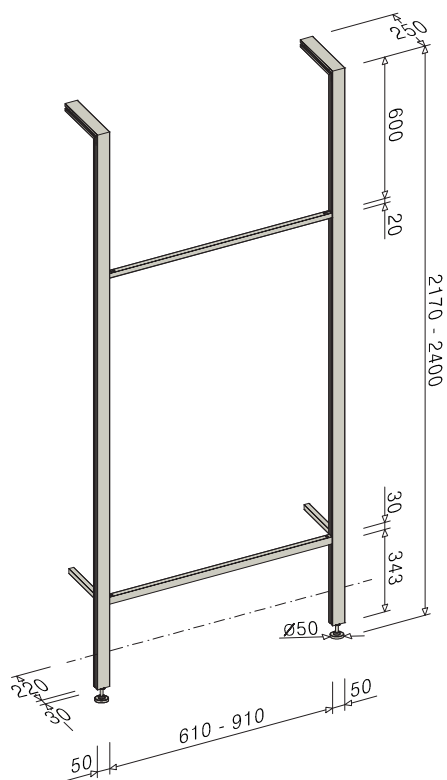

ALTEZZA E PROFONDITA' H.2170 P.250 MM
HEIGHT AND DEPTH H.2170 D.250 MM

		CODICE Code	
■ Nero	Black	L.71	0890350AL11
■ Titanio	Titanium	L.71	0890350AL12
■ Selce	Flint	L.71	0890350AL13
■ S.Dark	Dark Silver	L.71	0890350AL14
■ Nero	Black	L.101	0890355AL11
■ Titanio	Titanium	L.101	0890355AL12
■ Selce	Flint	L.101	0890355AL13
■ S.Dark	Dark Silver	L.101	0890355AL14

ALTEZZA E PROFONDITA' H.2400 P.250 MM
HEIGHT AND DEPTH H.2400 D.250 MM

		CODICE Code	
■ Nero	Black	L.71	0890351AL11
■ Titanio	Titanium	L.71	0890351AL12
■ Selce	Flint	L.71	0890351AL13
■ S.Dark	Dark Silver	L.71	0890351AL14
■ Nero	Black	L.101	0890356AL11
■ Titanio	Titanium	L.101	0890356AL12
■ Selce	Flint	L.101	0890356AL13
■ S.Dark	Dark Silver	L.101	0890356AL14

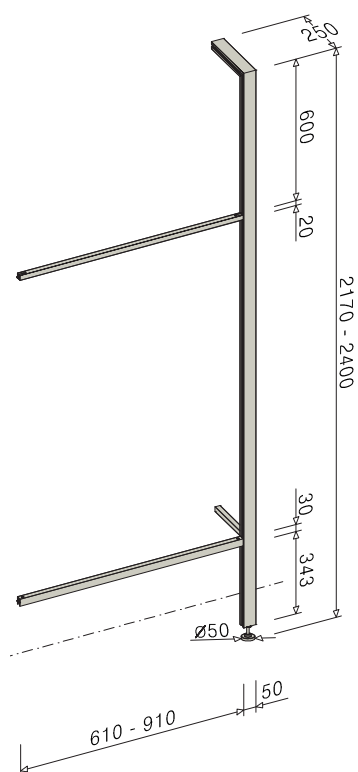

ALTEZZA E PROFONDITA' H.2170 P.250 MM
HEIGHT AND DEPTH H.2170 D.250 MM

CODICE Code			
■ Nero	Black	L.66	0890352AL11
■ Titanio	Titanium	L.66	0890352AL12
■ Selce	Flint	L.66	0890352AL13
■ S.Dark	Dark Silver	L.66	0890352AL14
■ Nero	Black	L.96	0890357AL11
■ Titanio	Titanium	L.96	0890357AL12
■ Selce	Flint	L.96	0890357AL13
■ S.Dark	Dark Silver	L.96	0890357AL14

ALTEZZA E PROFONDITA' H.2400 P.250 MM
HEIGHT AND DEPTH H.2400 D.250 MM

CODICE Code			
■ Nero	Black	L.66	0890353AL11
■ Titanio	Titanium	L.66	0890353AL12
■ Selce	Flint	L.66	0890353AL13
■ S.Dark	Dark Silver	L.66	0890353AL14
■ Nero	Black	L.96	0890358AL11
■ Titanio	Titanium	L.96	0890358AL12
■ Selce	Flint	L.96	0890358AL13
■ S.Dark	Dark Silver	L.96	0890358AL14

Tower Hi-Line a parete con ancoraggi al soffitto

Wall-leaning Tower Hi-Line with anchoring to the ceiling

Senza illuminazione
Without lighting

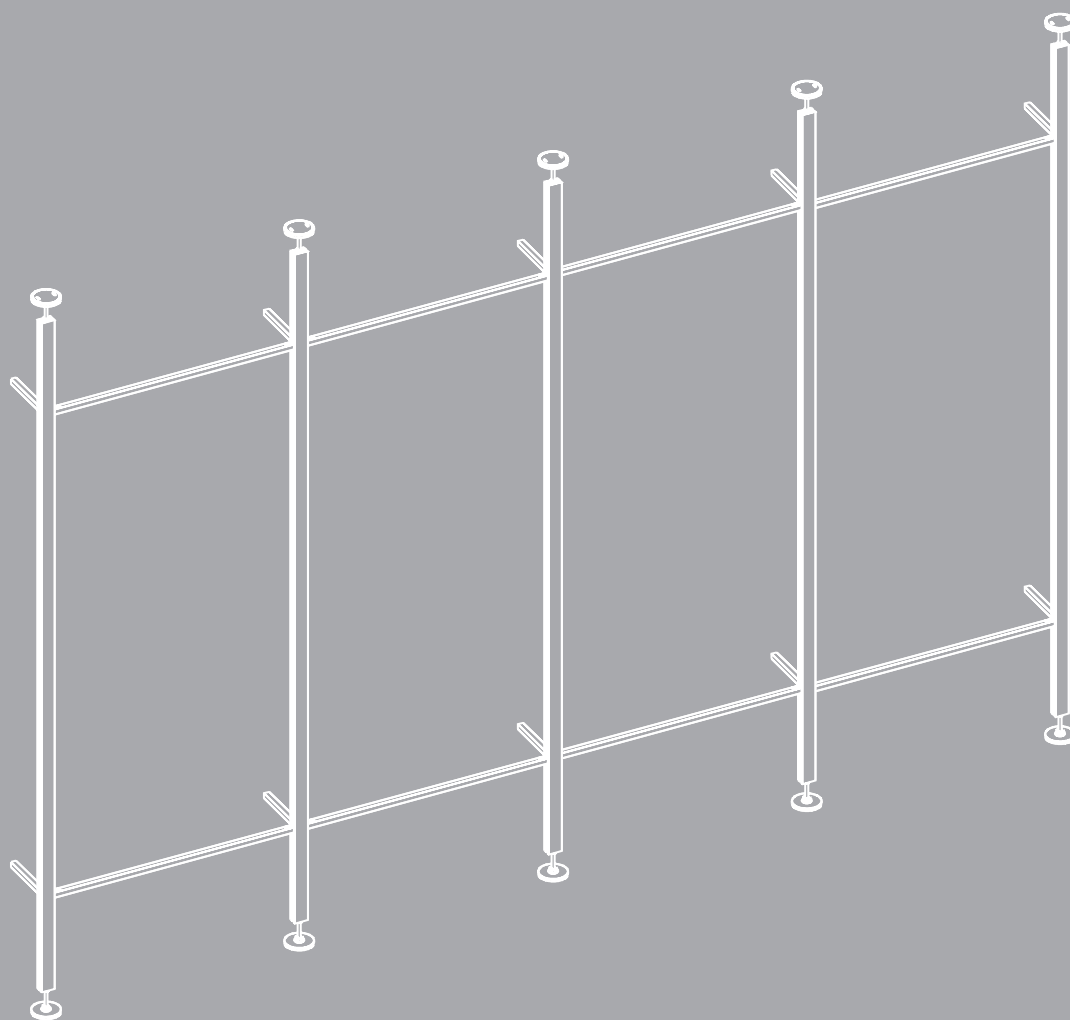

Tower Hi-Line a parete con ancoraggi al soffitto
 Wall-leaning Tower Hi-Line with anchoring to the ceiling

SENZA ILLUMINAZIONE
 H.2700 P.250 MM
 Without lighting H.2700 D.250 mm

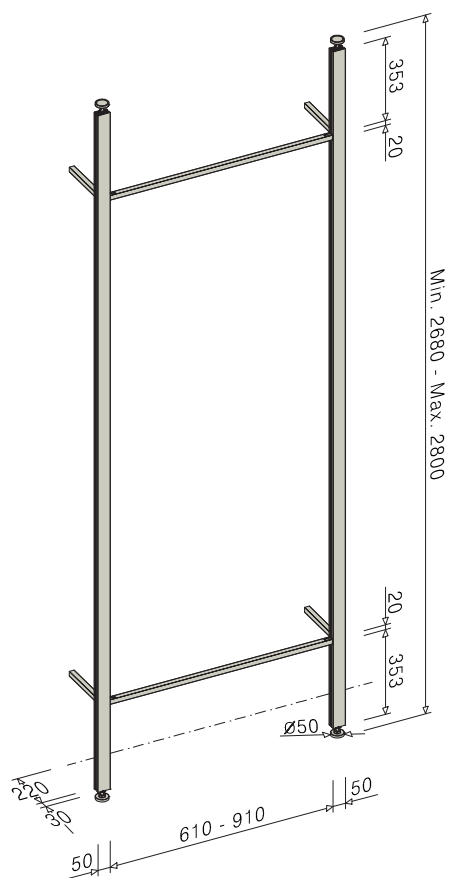

ALTEZZA E PROFONDITA' H.2700 P.250 MM
HEIGHT AND DEPTH H.2700 D.250 MM

		CODICE Code	
■ Nero	Black	L.71	0890370AL11
■ Titanio	Titanium	L.71	0890370AL12
■ Selce	Flint	L.71	0890370AL13
■ S.Dark	Dark Silver	L.71	0890370AL14
■ Nero	Black	L.101	0890375AL11
■ Titanio	Titanium	L.101	0890375AL12
■ Selce	Flint	L.101	0890375AL13
■ S.Dark	Dark Silver	L.101	0890375AL14

N.B. I distanziali a disegno sono per un possibile ancoraggio a muro.

Note: The spacers in the drawing are for a possible wall anchoring.

Montante Tower Hi-Line a parete con ancoraggi al soffitto
 Wall-leaning Tower Hi-Line pillar with anchoring to the ceiling

SENZA ILLUMINAZIONE
 H.2700 P.250 MM
 Without lighting H.2700 D.250 mm

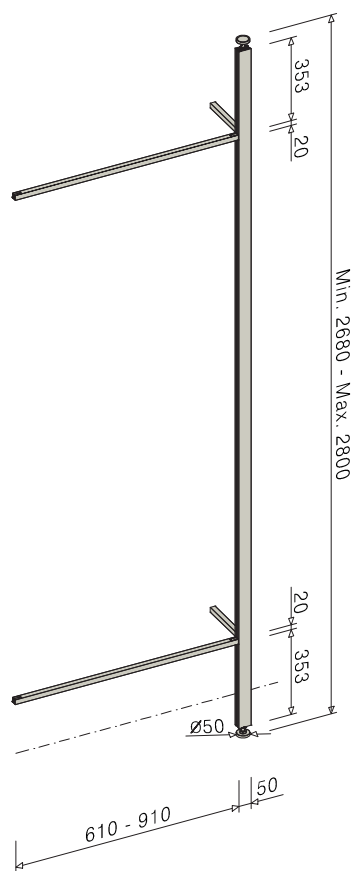

ALTEZZA E PROFONDITA' H.2700 P.250 MM
 HEIGHT AND DEPTH H.2700 D.250 MM

		CODICE Code	
■ Nero	Black	L.66	0890372AL11
■ Titanio	Titanium	L.66	0890372AL12
■ Selce	Flint	L.66	0890372AL13
■ S.Dark	Dark Silver	L.66	0890372AL14
■ Nero	Black	L.96	0890377AL11
■ Titanio	Titanium	L.96	0890377AL12
■ Selce	Flint	L.96	0890377AL13
■ S.Dark	Dark Silver	L.96	0890377AL14

N.B. I distanziali a disegno sono per un possibile ancoraggio a muro.

Note: The spacers in the drawing are for a possible wall anchoring.

Tower Hi-Line a parete con ancoraggi al soffitto
 Wall-leaning Tower Hi-Line with anchoring to the ceiling

SENZA ILLUMINAZIONE
 H.3000 P.250 MM
 Without lighting H.3000 D.250 mm

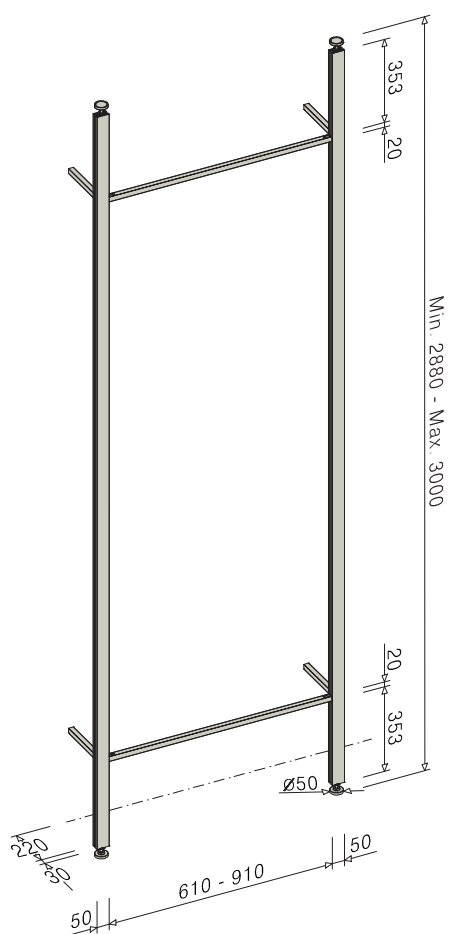

ALTEZZA E PROFONDITA' H.3000 P.250 MM
 HEIGHT AND DEPTH H.3000 D.250 MM

		CODICE Code	
■ Nero	Black	L.71	0890371AL11
■ Titanio	Titanium	L.71	0890371AL12
■ Selce	Flint	L.71	0890371AL13
■ S.Dark	Dark Silver	L.71	0890371AL14
■ Nero	Black	L.101	0890376AL11
■ Titanio	Titanium	L.101	0890376AL12
■ Selce	Flint	L.101	0890376AL13
■ S.Dark	Dark Silver	L.101	0890376AL14

N.B. I distanziali a disegno sono per un possibile ancoraggio a muro.

Note: The spacers in the drawing are for a possible wall anchoring.

Montante Tower Hi-Line a parete con ancoraggi al soffitto
 Wall-leaning Tower Hi-Line pillar with anchoring to the ceiling

SENZA ILLUMINAZIONE
 H.3000 P.250 MM
 Without lighting H.3000 D.250 mm

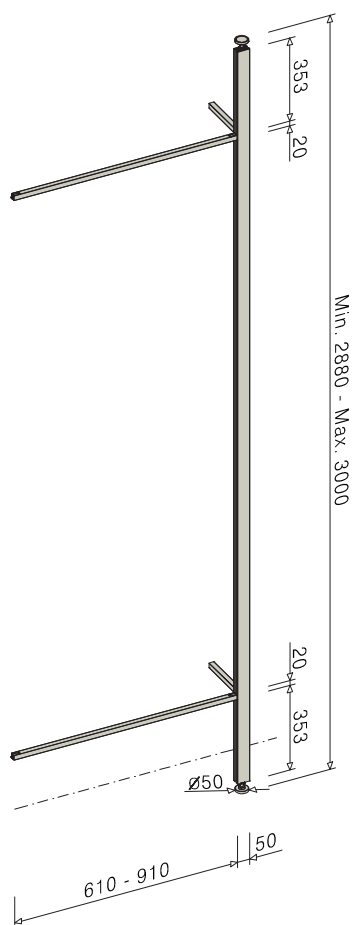

ALTEZZA E PROFONDITA' H.3000 P.250 MM
 HEIGHT AND DEPTH H.3000 D.250 MM

		CODICE Code	
■ Nero	Black	L.66	0890373AL11
■ Titanio	Titanium	L.66	0890373AL12
■ Selce	Flint	L.66	0890373AL13
■ S.Dark	Dark Silver	L.66	0890373AL14
■ Nero	Black	L.96	0890378AL11
■ Titanio	Titanium	L.96	0890378AL12
■ Selce	Flint	L.96	0890378AL13
■ S.Dark	Dark Silver	L.96	0890378AL14

N.B. I distanziali a disegno sono per un possibile ancoraggio a muro.

Note: The spacers in the drawing are for a possible wall anchoring.

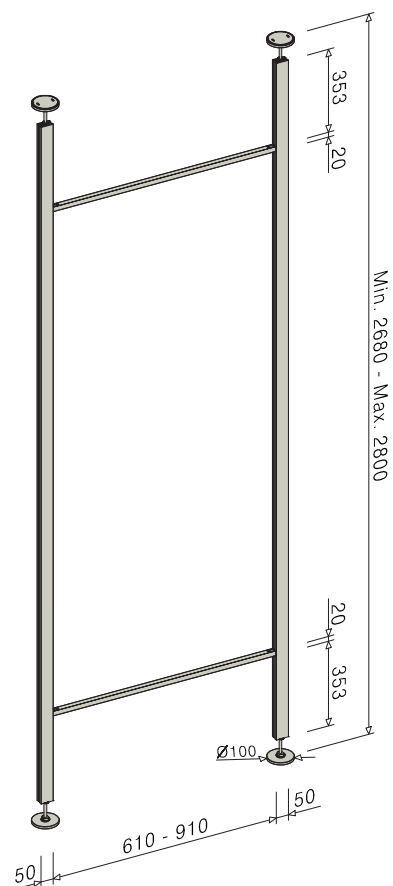

ALTEZZA E PROFONDITA' H.2700 P.250 MM
HEIGHT AND DEPTH H.2700 D.250 MM

		CODICE Code	
■ Nero	Black	L.76	0890380AL11
■ Titanio	Titanium	L.76	0890380AL12
■ Selce	Flint	L.76	0890380AL13
■ S.Dark	Dark Silver	L.76	0890380AL14
■ Nero	Black	L.106	0890385AL11
■ Titanio	Titanium	L.106	0890385AL12
■ Selce	Flint	L.106	0890385AL13
■ S.Dark	Dark Silver	L.106	0890385AL14

Montante Tower Hi-Line a isola
Wall-leaning Island Tower Hi-Line

SENZA ILLUMINAZIONE
H.2700 P.250 MM
Without lighting H.2700 D.250 mm

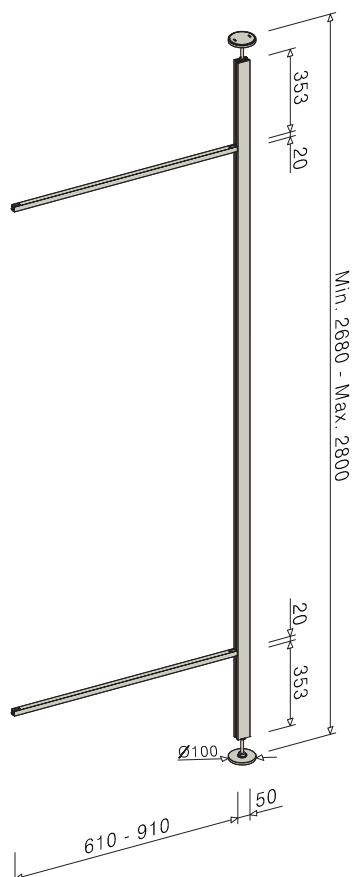

ALTEZZA E PROFONDITA' H.2700 P.250 MM
HEIGHT AND DEPTH H.2700 D.250 MM

		CODICE Code	
■ Nero	Black	L.68,5	0890382AL11
■ Titanio	Titanium	L.68,5	0890382AL12
■ Selce	Flint	L.68,5	0890382AL13
■ S.Dark	Dark Silver	L.68,5	0890382AL14
■ Nero	Black	L.98,5	0890387AL11
■ Titanio	Titanium	L.98,5	0890387AL12
■ Selce	Flint	L.98,5	0890387AL13
■ S.Dark	Dark Silver	L.98,5	0890387AL14

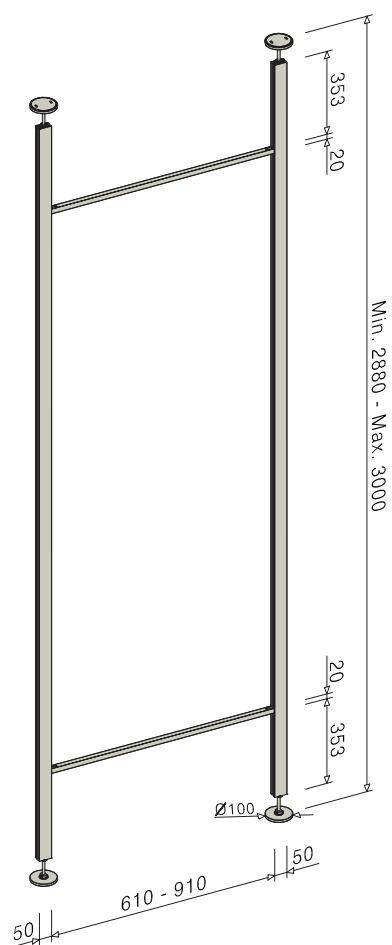

ALTEZZA E PROFONDITA' H.3000 P.250 MM
HEIGHT AND DEPTH H.3000 D.250 MM

		CODICE Code	
■ Nero	Black	L.76	0890381AL11
■ Titanio	Titanium	L.76	0890381AL12
■ Selce	Flint	L.76	0890381AL13
■ S.Dark	Dark Silver	L.76	0890381AL14
■ Nero	Black	L.106	0890386AL11
■ Titanio	Titanium	L.106	0890386AL12
■ Selce	Flint	L.106	0890386AL13
■ S.Dark	Dark Silver	L.106	0890386AL14

Montante Tower Hi-Line a isola
Wall-leaning Island Tower Hi-Line

SENZA ILLUMINAZIONE
H.3000 P.250 MM
Without lighting H.3000 D.250 mm

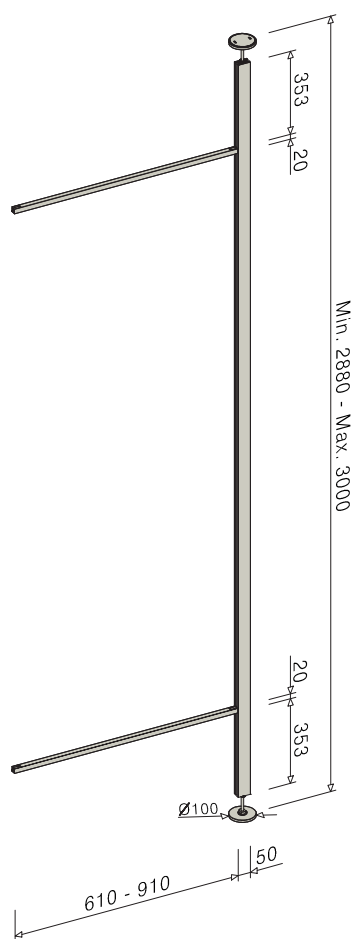

ALTEZZA E PROFONDITA' H.3000 P.250 MM
HEIGHT AND DEPTH H.3000 D.250 MM

		CODICE Code	
■ Nero	Black	L.68,5	0890383AL11
■ Titanio	Titanium	L.68,5	0890383AL12
■ Selce	Flint	L.68,5	0890383AL13
■ S.Dark	Dark Silver	L.68,5	0890383AL14
■ Nero	Black	L.98,5	0890388AL11
■ Titanio	Titanium	L.98,5	0890388AL12
■ Selce	Flint	L.98,5	0890388AL13
■ S.Dark	Dark Silver	L.98,5	0890388AL14

Mensole e complementi

Shelves and furnishing accessories

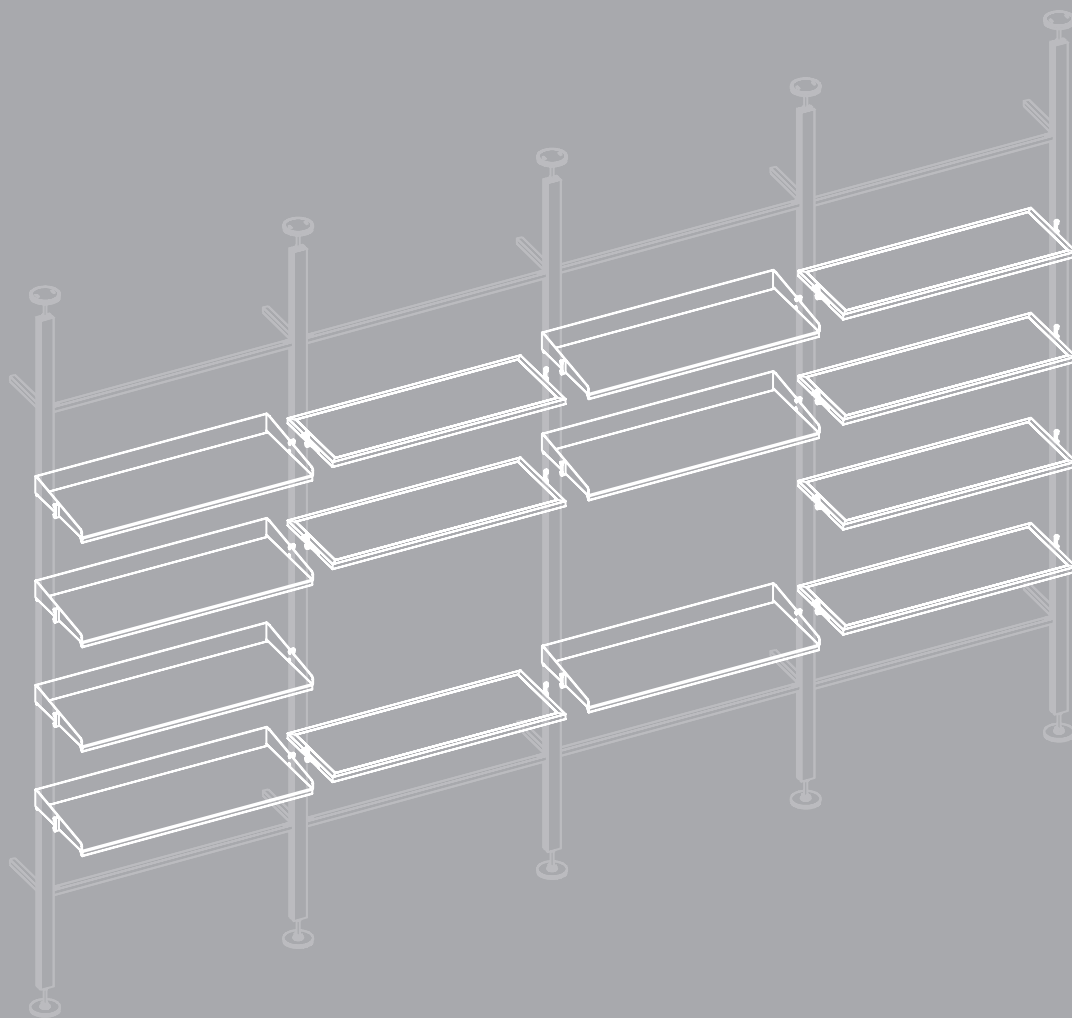

Mensola in lamiera Sheet metal shelf

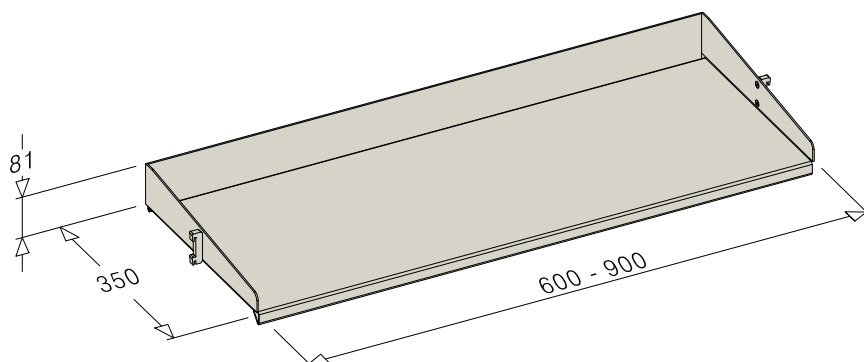

ALTEZZA E PROFONDITA' H.8,1 P.35 CM
HEIGHT AND DEPTH H.8,1 D.35 CM

		CODICE Code	
■ Nero	Black	L.60	0890425AL11
■ Titanio	Titanium	L.60	0890425AL12
■ Selce	Flint	L.60	0890425AL13
■ S.Dark	Dark Silver	L.60	0890425AL14
■ Nero	Black	L.90	0890426AL11
■ Titanio	Titanium	L.90	0890426AL12
■ Selce	Flint	L.90	0890426AL13
■ S.Dark	Dark Silver	L.90	0890426AL14

N.B. Nell'imballo di ogni mensola è previsto un KIT di coppia agganci per mensole in alluminio con apposita viteria.

Note: In the packaging of each shelf there is a pair of hooks kit for aluminum shelves with appropriate screws.

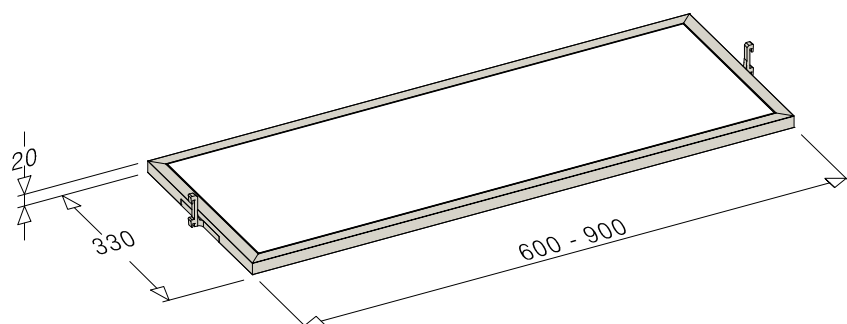

ALTEZZA E PROFONDITA' H.2 P.33 CM
HEIGHT AND DEPTH H.2 D.33 CM

			VETRO Glass	CODICE Code
■ Nero	Black	L.60	Fume'	089045AL11FUM
■ Titanio	Titanium	L.60	Fume'	089045AL12FUM
■ Selce	Flint	L.60	Fume'	089045AL13FUM
■ S.Dark	Dark Silver	L.60	Fume'	089045AL14FUM
■ Nero	Black	L.60	Bronzo	089045AL11BRO
■ Titanio	Titanium	L.60	Bronzo	089045AL12BRO
■ Selce	Flint	L.60	Bronzo	089045AL13BRO
■ S.Dark	Dark Silver	L.60	Bronzo	089045AL14BRO
■ Nero	Black	L.60	Ex.Chiaro	089045AL11TRA
■ Titanio	Titanium	L.60	Ex.Chiaro	089045AL12TRA
■ Selce	Flint	L.60	Ex.Chiaro	089045AL13TRA
■ S.Dark	Dark Silver	L.60	Ex.Chiaro	089045AL14TRA
■ Nero	Black	L.90	Fume'	089046AL11FUM
■ Titanio	Titanium	L.90	Fume'	089046AL12FUM
■ Selce	Flint	L.90	Fume'	089046AL13FUM
■ S.Dark	Dark Silver	L.90	Fume'	089046AL14FUM
■ Nero	Black	L.90	Bronzo	089046AL11BRO
■ Titanio	Titanium	L.90	Bronzo	089046AL12BRO
■ Selce	Flint	L.90	Bronzo	089046AL13BRO
■ S.Dark	Dark Silver	L.90	Bronzo	089046AL14BRO
■ Nero	Black	L.90	Ex.Chiaro	089046AL11TRA
■ Titanio	Titanium	L.90	Ex.Chiaro	089046AL12TRA
■ Selce	Flint	L.90	Ex.Chiaro	089046AL13TRA
■ S.Dark	Dark Silver	L.90	Ex.Chiaro	089046AL14TRA

N.B. Nell'imballo di ogni mensola è previsto un KIT di coppia agganci per mensole in alluminio con apposita viteria.

Note: In the packaging of each shelf there is a pair of hooks kit for aluminum shelves with appropriate screws.

**Nero
Anodizzato
(opz.AL11)**
Black
Anodized
(opt.AL11)

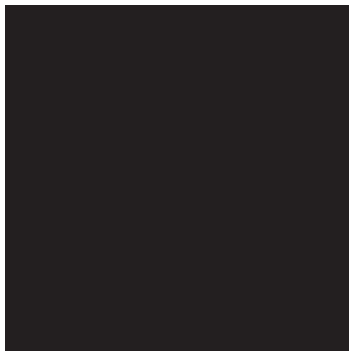

**Selce
Verniciato
(opz.AL13)**
Flint
Painted
(opt.AL13)



**Titanio
Anodizzato
(opz.AL12)**
Titanium
Anodized
(opt.AL12)

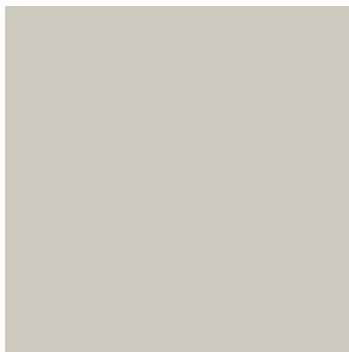

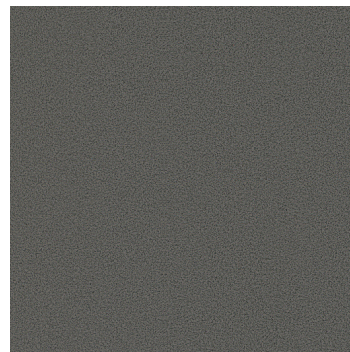

**Silver Dark
Verniciato
(opz.AL14)**
Dark Silver
Painted
(opt.AL14)







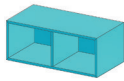
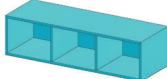
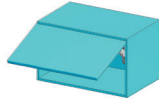
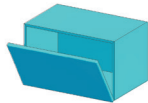
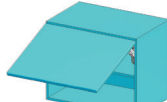
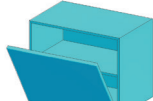

ELEMENTI FOLDING PER TOWER HI-LINE A PARETE (per finiture mod. IMMAGINA)

FOLDING ELEMENTS FOR WALL MOUNTED TOWER HI-LINE STRUCTURE (for finishes model IMMAGINA)

			COD.	ANTA MELAMINICO	ANTA IMPIALLACCIATA WOOD	ANTA LACCATA OPACA LISCIA	ANTA VETRO TELAIO ALLUMINIO		
 <p>pensile a giorno con 2 vani attaccaglie a scomparsa open wall unit with 2 compartments concealed hangers</p>	<p>L 60 H 36 P 31 SP. 1,8</p> <p>Melaminico</p> <p>Impiallacciato Wood</p>								
			E7701611T						
			E7702711T						
 <p>pensile a giorno con 3 vani attaccaglie a scomparsa open wall unit with 3 compartments concealed hangers</p>	<p>L 90 H 36 P 31 SP. 1,8</p> <p>Melaminico</p> <p>Impiallacciato Wood</p>								
			E7701612T						
			E7702712T						
 <p>pensile 1 anta ribalta tip-on flap door wall unit</p>	<p>Melaminico H 36 P 33,4 L 60</p> <p>L 90</p> <p>Impiallacciato Wood H 36 P 33,4 L 60</p> <p>L 90</p>		EPF22600T						
			EPF22900T						
			EPF2260IT						
			EPF2290IT						
 <p>pensile 1 anta apertura a vasistas con push-pull (opz.996) wall unit 1 door flap door with push-pull opening (opt.996)</p>	<p>Melaminico H 36 P 33,4 L 60</p> <p>L 90</p> <p>Impiallacciato Wood H 36 P 33,4 L 60</p> <p>L 90</p>		EPF52600T						
			EPF52900T						
			EPF5260IT						
			EPF5290IT						
 <p>pensile 1 anta ribalta tip-on flap door wall unit</p>	<p>Melaminico H 48 P 33,4 L 60</p> <p>L 90</p> <p>Impiallacciato Wood H 48 P 33,4 L 60</p> <p>L 90</p>		EPF23600T						
			EPF23900T						
			EPF2360IT						
			EPF2390IT						
 <p>pensile 1 anta apertura a vasistas con push-pull (opz.996) wall unit 1 door flap door with push-pull opening (opt.996)</p>	<p>Melaminico H 48 P 33,4 L 60</p> <p>L 90</p> <p>Impiallacciato Wood H 48 P 33,4 L 60</p> <p>L 90</p>		EPF53600T						
			EPF53900T						
			EPF5360IT						
			EPF5390IT						
 <p>mensola Completa di agganci veneered shelf complete of rack hooks</p>	<p>Melaminico L 60 P 31 SP. 2,2</p> <p>L 90 P 31 SP. 2,2</p> <p>Impiallacciato Wood L 60 P 31 SP. 2,2</p> <p>L 90 P 31 SP. 2,2</p>		0890438M						
			0890448M						
			0890438W						
			0890448W						

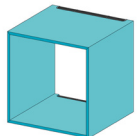
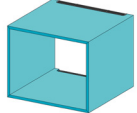
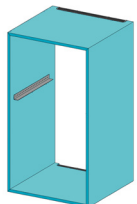

ELEMENTI FOLDING PER TOWER HI-LINE A PARETE (per finiture mod. IMMAGINA)

FOLDING ELEMENTS FOR WALL MOUNTED TOWER HI-LINE STRUCTURE (for finishes model IMMAGINA)

		COD.	ANTA MELAMINICO	ANTA IMPIAL-LACCIATA WOOD	ANTA LACCATA OPACA LISCIA	ANTA VETRO TELAIO ALLUMINIO		
 <p>pensile 1 anta H 36 1 door H 36 wall unit</p>	Melaminico P 33,4 L 60	EPF1260T1/2						
	Impiallacciato Wood P 33,4 L 60	EPF1260I1/2						
 <p>pensile 1 anta H 48 1 door H 48 wall unit</p>	Melaminico P 33,4 L 60	EPF1360T1/2						
	Impiallacciato Wood P 33,4 L 60	EPF1360I1/2						
 <p>pensile 1 anta H 36 telaio alluminio 1 door H 36 wall unit aluminium frame</p>	Laccato P 33,4 L 60	EPF1261V1/2						
	Melaminico P 33,4 L 60	EPF1264V1/2						
	Impiallacciato Wood P 33,4 L 60	EPF1263V1/2						
 <p>pensile 1 anta H 48 telaio alluminio ripiano vetro 1 door H 48 wall unit aluminium frame glass shelf</p>	Laccato P 33,4 L 60	EPF1361V1/2						
	Melaminico P 33,4 L 60	EPF1364V1/2						
	Impiallacciato Wood P 33,4 L 60	EPF1363V1/2						
 <p>elemento per forno element for oven</p>	Melaminico P 57,5 L 60	E7701641T						
	Impiallacciato Wood P 57,5 L 60	E7701645T						
 <p>elemento per micro element for micro</p>	Melaminico P 57,5 L 60	E7701651T						
	Impiallacciato Wood P 57,5 L 60	E7701655T						
 <p>elemento per forno+micro element for oven+micro</p>	Melaminico P 57,5 L 60	E7701661T						
	Impiallacciato Wood P 57,5 L 60	E7701665T						



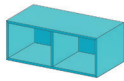
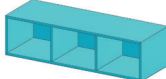
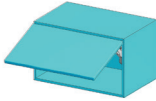
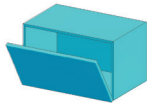
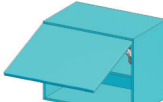
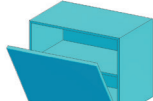

ELEMENTI FOLDING PER TOWER HI-LINE A PARETE (per finiture mod. CLOVER)

FOLDING ELEMENTS FOR WALL MOUNTED TOWER HI-LINE STRUCTURE (for finishes model CLOVER)

		COD.	ANTA IMPIAL- LACCIATA TELAIO A	ANTA IMPIAL- LACCIATA TELAIO B	ANTA LACCATA OPACA LISCIA	ANTA VETRO TELAIO ALLUMINIO			
 <p>pensile a giorno con 2 vani attaccaglie a scomparsa open wall unit with 2 compartments concealed hangers</p>	<p>L 60 H 36 P 31 SP. 1,4</p> <p>Laccato Opaco</p> <p>Impiallacciato</p>	E7701711T							
		E7702711T							
 <p>pensile a giorno con 3 vani attaccaglie a scomparsa open wall unit with 3 compartments concealed hangers</p>	<p>L 90 H 36 P 31 SP. 1,4</p> <p>Laccato Opaco</p> <p>Impiallacciato</p>	E7701712T							
		E7702712T							
 <p>pensile 1 anta ribalta tip-on flap door wall unit</p>	<p>Laccato Opaco H 36 P 33,4 L 60</p> <p>L 90</p> <p>Impiallacciato H 36 P 33,4 L 60</p> <p>L 90</p>	EPF2260LT							
		EPF2290LT							
		EPF2260IT							
		EPF2290IT							
 <p>pensile 1 anta apertura a vasistas con push-pull (opz.996) wall unit 1 door flap door with push-pull opening (opt.996)</p>	<p>Laccato Opaco H 36 P 33,4 L 60</p> <p>L 90</p> <p>Impiallacciato H 36 P 33,4 L 60</p> <p>L 90</p>	EPF5260LT							
		EPF5290LT							
		EPF5260IT							
		EPF5290IT							
 <p>pensile 1 anta ribalta tip-on flap door wall unit</p>	<p>Laccato Opaco H 48 P 33,4 L 60</p> <p>L 90</p> <p>Impiallacciato H 48 P 33,4 L 60</p> <p>L 90</p>	EPF2360LT							
		EPF2390LT							
		EPF2360IT							
		EPF2390IT							
 <p>pensile 1 anta apertura a vasistas con push-pull (opz.996) wall unit 1 door flap door with push-pull opening (opt.996)</p>	<p>Laccato Opaco H 48 P 33,4 L 60</p> <p>L 90</p> <p>Impiallacciato H 48 P 33,4 L 60</p> <p>L 90</p>	EPF5360LT							
		EPF5390LT							
		EPF5360IT							
		EPF5390IT							
 <p>mensola Completa di agganci veneered shelf complete of rack hooks</p>	<p>Laccato Opaco L 60 P 31 SP. 2,2</p> <p>L 90 P 31 SP. 2,2</p> <p>Impiallacciato L 60 P 31 SP. 2,2</p> <p>L 90 P 31 SP. 2,2</p>	0890438T							
		0890448T							
		0890436T							
		0890446T							

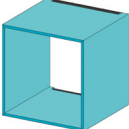
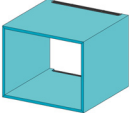
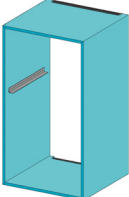

ELEMENTI FOLDING PER TOWER HI-LINE A PARETE (per finiture mod. CLOVER)

FOLDING ELEMENTS FOR WALL MOUNTED TOWER HI-LINE STRUCTURE (for finishes model CLOVER)

		COD.	ANTA IMPIAL- LACCIATA TELAIO A	ANTA IMPIAL- LACCIATA TELAIO B	ANTA LACCATA OPACA LISCIA	ANTA VETRO TELAIO ALLUM. A	ANTA VETRO TELAIO ALLUM. B	
 <p>pensile 1 anta H 36 1 door H 36 wall unit</p>								
	Laccato Opaco P 33,4 L 60	EPF1260L1/2						
	Impiallacciato P 33,4 L 60	EPF1260I1/2						
 <p>pensile 1 anta H 48 1 door H 48 wall unit</p>								
	Laccato Opaco P 33,4 L 60	EPF1360L1/2						
	Impiallacciato P 33,4 L 60	EPF1360I1/2						
 <p>pensile 1 anta H 36 telaio alluminio 1 door H 36 wall unit aluminium frame</p>								
	Laccato Opaco P 33,4 L 60	EPF1261V1/2						
	Impiallacciato P 33,4 L 60	EPF1263V1/2						
 <p>pensile 1 anta H 48 telaio alluminio ripiano vetro 1 door H 48 wall unit aluminium frame glass shelf</p>								
	Laccato Opaco P 33,4 L 60	EPF1361V1/2						
	Impiallacciato P 33,4 L 60	EPF1363V1/2						
 <p>elemento per forno element for oven</p>								
	Laccato Opaco P 57,5 L 60	E7701643T						
	Impiallacciato P 57,5 L 60	E7701645T						
 <p>elemento per micro element for micro</p>								
	Laccato Opaco P 57,5 L 60	E7701653T						
	Impiallacciato P 57,5 L 60	E7701655T						
 <p>elemento per forno+micro element for oven+micro</p>								
	Laccato Opaco P 57,5 L 60	E7701663T						
	Impiallacciato P 57,5 L 60	E7701665T						



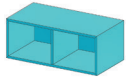
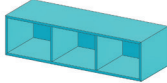
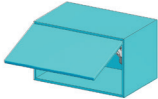
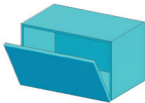
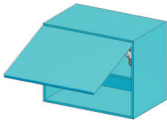
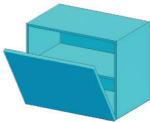

ELEMENTI FOLDING PER TOWER HI-LINE A PARETE (per finiture mod. LUNA)

FOLDING ELEMENTS FOR WALL MOUNTED TOWER HI-LINE STRUCTURE (for finishes model LUNA)

		COD.	ANTA IMPIAL- LACCIATA LISCIA A	ANTA IMPIAL- LACCIATA LISCIA B	ANTA LACCATA OPACA			
 <p>pensile a giorno con 2 vani attaccaglie a scomparsa open wall unit with 2 compartments concealed hangers</p>	L 60 H 36 P 31 SP. 1,4							
	Laccato Opaco	E7701711T						
	Impiallacciato	E7702711T						
 <p>pensile a giorno con 3 vani attaccaglie a scomparsa open wall unit with 3 compartments concealed hangers</p>	L 90 H 36 P 31 SP. 1,4							
	Laccato Opaco	E7701712T						
	Impiallacciato	E7702712T						
 <p>pensile 1 anta ribalta tip-on flap door wall unit</p>	Laccato Opaco H 36 P 33,4 L 60	EPF2260LT						
	L 90	EPF2290LT						
	Impiallacciato H 36 P 33,4 L 60	EPF2260IT						
	L 90	EPF2290IT						
 <p>pensile 1 anta apertura a vasistas con push-pull (opz.996) wall unit 1 door flap door with push-pull opening (opt.996)</p>	Laccato Opaco H 36 P 33,4 L 60	EPF5260LT						
	L 90	EPF5290LT						
	Impiallacciato H 36 P 33,4 L 60	EPF5260IT						
	L 90	EPF5290IT						
 <p>pensile 1 anta ribalta tip-on flap door wall unit</p>	Laccato Opaco H 48 P 33,4 L 60	EPF2360LT						
	L 90	EPF2390LT						
	Impiallacciato H 48 P 33,4 L 60	EPF2360IT						
	L 90	EPF2390IT						
 <p>pensile 1 anta apertura a vasistas con push-pull (opz.996) wall unit 1 door flap door with push-pull opening (opt.996)</p>	Laccato Opaco H 48 P 33,4 L 60	EPF5360LT						
	L 90	EPF5390LT						
	Impiallacciato H 48 P 33,4 L 60	EPF5360IT						
	L 90	EPF5390IT						
 <p>mensola Completa di agganci veneered shelf complete of rack hooks</p>	Laccato Opaco L 60 P 31 SP. 2,2	0890438T						
	L 90 P 31 SP. 2,2	0890448T						
	Impiallacciato L 60 P 31 SP. 2,2	0890436T						
	L 90 P 31 SP. 2,2	0890446T						

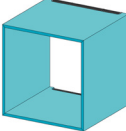
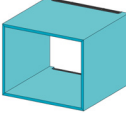
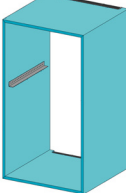

ELEMENTI FOLDING PER TOWER HI-LINE A PARETE (per finiture mod. LUNA)

FOLDING ELEMENTS FOR WALL MOUNTED TOWER HI-LINE STRUCTURE (for finishes model LUNA)

		COD.	ANTA IMPIAL- LACCIATA LISCIA A	ANTA IMPIAL- LACCIATA LISCIA B	ANTA LACCATA OPACA			
 <p>pensile 1 anta H 36 1 door H 36 wall unit</p>	Laccato Opaco P 33,4 L 60	EPF1260L1/2						
	Impiallacciato P 33,4 L 60	EPF1260I1/2						
 <p>pensile 1 anta H 48 1 door H 48 wall unit</p>	Laccato Opaco P 33,4 L 60	EPF1360L1/2						
	Impiallacciato P 33,4 L 60	EPF1360I1/2						
 <p>pensile 1 anta H 36 telaio alluminio 1 door H 36 wall unit aluminium frame</p>	Laccato Opaco P 33,4 L 60	EPF1261V1/2						
	Impiallacciato P 33,4 L 60	EPF1263V1/2						
 <p>pensile 1 anta H 48 telaio alluminio ripiano vetro 1 door H 48 wall unit aluminium frame glass shelf</p>	Laccato Opaco P 33,4 L 60	EPF1361V1/2						
	Impiallacciato P 33,4 L 60	EPF1363V1/2						
 <p>elemento per forno element for oven</p>	Laccato Opaco P 57,5 L 60	E7701643T						
	Impiallacciato P 57,5 L 60	E7701645T						
 <p>elemento per micro element for micro</p>	Laccato Opaco P 57,5 L 60	E7701653T						
	Impiallacciato P 57,5 L 60	E7701655T						
 <p>elemento per forno+micro element for oven+micro</p>	Laccato Opaco P 57,5 L 60	E7701663T						
	Impiallacciato P 57,5 L 60	E7701665T						



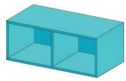
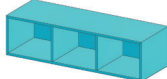
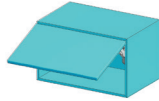
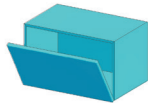
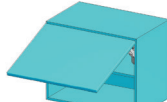
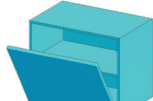

ELEMENTI FOLDING PER TOWER HI-LINE A PARETE (per finiture mod. FLAVOUR)

FOLDING ELEMENTS FOR WALL MOUNTED TOWER HI-LINE STRUCTURE (for finishes model FLAVOUR)

		COD.	ANTA IMPIAL- LACCIATA TELAIO A	ANTA IMPIAL- LACCIATA TELAIO B	ANTA IMPIAL- LACCIATA TELAIO C	ANTA LACCATA OPACA TELAIO	ANTA LACCATA OPACA LISCIA	ANTA VETRO TELAIO ALLUMINIO
 <p>pensile a giorno con 2 vani attaccaglie a scomparsa open wall unit with 2 compartments concealed hangers</p>	<p>L 60 H 36 P 31 SP. 1,4 Laccato Opaco Impiallacciato</p>							
		E7701711T						
		E7702711T						
 <p>pensile a giorno con 3 vani attaccaglie a scomparsa open wall unit with 3 compartments concealed hangers</p>	<p>L 90 H 36 P 31 SP. 1,4 Laccato Opaco Impiallacciato</p>							
		E7701712T						
		E7702712T						
 <p>pensile 1 anta ribalta tip-on flap door wall unit</p>	<p>Laccato Opaco H 36 P 33,6 L 60 L 90 Impiallacciato H 36 P 33,6 L 60 L 90</p>	EPF2260LT						
		EPF2290LT						
		EPF2260IT						
		EPF2290IT						
 <p>pensile 1 anta apertura a vasistas con push-pull (opz.996) wall unit 1 door flap door with push-pull opening (opt.996)</p>	<p>Laccato Opaco H 36 P 33,6 L 60 L 90 Impiallacciato H 36 P 33,6 L 60 L 90</p>	EPF5260LT						
		EPF5290LT						
		EPF5260IT						
		EPF5290IT						
 <p>pensile 1 anta ribalta tip-on flap door wall unit</p>	<p>Laccato Opaco H 48 P 33,6 L 60 L 90 Impiallacciato H 48 P 33,6 L 60 L 90</p>	EPF2360LT						
		EPF2390LT						
		EPF2360IT						
		EPF2390IT						
 <p>pensile 1 anta apertura a vasistas con push-pull (opz.996) wall unit 1 door flap door with push-pull opening (opt.996)</p>	<p>Laccato Opaco H 48 P 33,6 L 60 L 90 Impiallacciato H 48 P 33,6 L 60 L 90</p>	EPF5360LT						
		EPF5390LT						
		EPF5360IT						
		EPF5390IT						
 <p>mensola Completa di agganci veneered shelf complete of rack hooks</p>	<p>Laccato Opaco L 60 P 31 SP. 2,2 L 90 P 31 SP. 2,2 Impiallacciato L 60 P 31 SP. 2,2 L 90 P 31 SP. 2,2</p>	0890438T						
		0890448T						
		0890436T						
		0890446T						

ELEMENTI FOLDING PER TOWER HI-LINE A PARETE (per finiture mod. FLAVOUR)

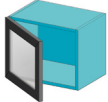
FOLDING ELEMENTS FOR WALL MOUNTED TOWER HI-LINE STRUCTURE (for finishes model FLAVOUR)

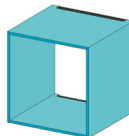
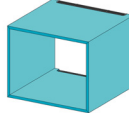
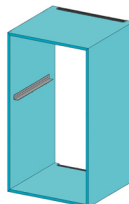
		COD.	ANTA IMPIAL- LACCIATA TELAIO A	ANTA IMPIAL- LACCIATA TELAIO B	ANTA IMPIAL- LACCIATA TELAIO C	ANTA LACCATA OPACA TELAIO	ANTA LACCATA OPACA LISCIA	ANTA VETRO TELAIO ALLUMINIO
 <p>pensile 1 anta H 36 1 door H 36 wall unit</p>								
	Laccato Opaco P 33,4 L 60	EPF1260L1/2						
	Impiallacciato P 33,4 L 60	EPF1260I1/2						
 <p>pensile 1 anta H 48 1 door H 48 wall unit</p>								
	Laccato Opaco P 33,4 L 60	EPF1360L1/2						
	Impiallacciato P 33,4 L 60	EPF1360I1/2						
 <p>pensile 1 anta H 36 telaio alluminio 1 door H 36 wall unit aluminium frame</p>								
	Laccato Opaco P 33,4 L 60	EPF1261V1/2						
	Impiallacciato P 33,4 L 60	EPF1263V1/2						
 <p>pensile 1 anta H 48 telaio alluminio ripiano vetro 1 door H 48 wall unit aluminium frame glass shelf</p>								
	Laccato Opaco P 33,4 L 60	EPF1361V1/2						
	Impiallacciato P 33,4 L 60	EPF1363V1/2						
 <p>elemento per forno element for oven</p>								
	Laccato Opaco P 57,5 L 60	E7701643T						
	Impiallacciato P 57,5 L 60	E7701645T						
 <p>elemento per micro element for micro</p>								
	Laccato Opaco P 57,5 L 60	E7701653T						
	Impiallacciato P 57,5 L 60	E7701655T						
 <p>elemento per forno+micro element for oven+micro</p>								
	Laccato Opaco P 57,5 L 60	E7701663T						
	Impiallacciato P 57,5 L 60	E7701665T						



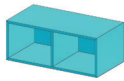
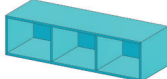
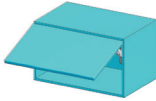
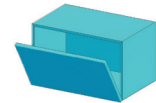
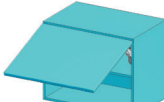
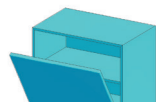

ELEMENTI FOLDING PER TOWER HI-LINE A PARETE (per finiture mod. OLTRE)

FOLDING ELEMENTS FOR WALL MOUNTED TOWER HI-LINE STRUCTURE (for finishes model OLTRE)

			COD.	ANTA IMPIAL- LACCIATA LISCIA	ANTA LACCATA OPACA	ANTA VETRO TELAIO ALLUM. FA	ANTA VETRO TELAIO ALLUM. FB		
 <p>pensile a giorno con 2 vani attaccaglie a scomparsa open wall unit with 2 compartments concealed hangers</p>	<p>L 60 H 36 P 31 SP. 1,4 Laccato Opaco Impiallacciato</p>								
			E7701711T						
			E7702711T						
 <p>pensile a giorno con 3 vani attaccaglie a scomparsa open wall unit with 3 compartments concealed hangers</p>	<p>L 90 H 36 P 31 SP. 1,4 Laccato Opaco Impiallacciato</p>								
			E7701712T						
			E7702712T						
 <p>pensile 1 anta ribalta tip-on flap door wall unit</p>	<p>Laccato Opaco H 36 P 33,4 L 60 L 90 Impiallacciato H 36 P 33,4 L 60 L 90</p>								
			EPF2260LT						
			EPF2290LT						
			EPF2260IT						
 <p>pensile 1 anta apertura a vasistas con push-pull (opz.996) wall unit 1 door flap door with push-pull opening (opt.996)</p>	<p>Laccato Opaco H 36 P 33,4 L 60 L 90 Impiallacciato H 36 P 33,4 L 60 L 90</p>								
			EPF5260LT						
			EPF5290LT						
			EPF5260IT						
 <p>pensile 1 anta ribalta tip-on flap door wall unit</p>	<p>Laccato Opaco H 48 P 33,4 L 60 L 90 Impiallacciato H 48 P 33,4 L 60 L 90</p>								
			EPF2360LT						
			EPF2390LT						
			EPF2360IT						
 <p>pensile 1 anta apertura a vasistas con push-pull (opz.996) wall unit 1 door flap door with push-pull opening (opt.996)</p>	<p>Laccato Opaco H 48 P 33,4 L 60 L 90 Impiallacciato H 48 P 33,4 L 60 L 90</p>								
			EPF5360LT						
			EPF5390LT						
			EPF5360IT						

ELEMENTI FOLDING PER TOWER HI-LINE A PARETE (per finiture mod. OLTRE)

FOLDING ELEMENTS FOR WALL MOUNTED TOWER HI-LINE STRUCTURE (for finishes model OLTRE)

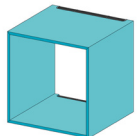
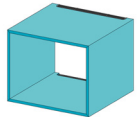
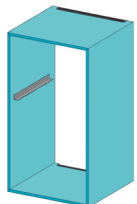
		COD.	ANTA IMPIAL- LACCIATA LISCIA	ANTA LACCATA OPACA	ANTA VETRO TELAIO ALLUM. FA	ANTA VETRO TELAIO ALLUM. FB		
 <p>pensile 1 anta H 36 1 door H 36 wall unit</p>								
	Laccato Opaco P 33,4 L 60	EPF1260L1/2						
	Impiallacciato P 33,4 L 60	EPF1260I1/2						
 <p>pensile 1 anta H 48 1 door H 48 wall unit</p>								
	Laccato Opaco P 33,4 L 60	EPF1360L1/2						
	Impiallacciato P 33,4 L 60	EPF1360I1/2						
 <p>pensile 1 anta H 36 telaio alluminio 1 door H 36 wall unit aluminium frame</p>								
	Laccato Opaco P 33,4 L 60	EPF1261V1/2						
	Impiallacciato P 33,4 L 60	EPF1263V1/2						
 <p>pensile 1 anta H 48 telaio alluminio ripiano vetro 1 door H 48 wall unit aluminium frame glass shelf</p>								
	Laccato Opaco P 33,4 L 60	EPF1361V1/2						
	Impiallacciato P 33,4 L 60	EPF1363V1/2						
 <p>elemento per forno element for oven</p>								
	Laccato Opaco P 57,5 L 60	E7701643T						
	Impiallacciato P 57,5 L 60	E7701645T						
 <p>elemento per micro element for micro</p>								
	Laccato Opaco P 57,5 L 60	E7701653T						
	Impiallacciato P 57,5 L 60	E7701655T						
 <p>elemento per forno+micro element for oven+micro</p>								
	Laccato Opaco P 57,5 L 60	E7701663T						
	Impiallacciato P 57,5 L 60	E7701665T						

ELEMENTI FOLDING PER TOWER HI-LINE A PARETE (per finiture mod. OLTRE)

FOLDING ELEMENTS FOR WALL MOUNTED TOWER HI-LINE STRUCTURE (for finishes model OLTRE)

mensola a parete

Completa di agganci

veneered shelf for wall
complete of rack hooks

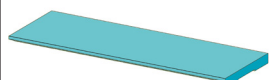

L 60 P 31 SP. 3,8

0890432

L 90 P 31 SP. 3,8

0890442

L 60 P 31 SP. 3,8

0890434

L 90 P 31 SP. 3,8

0890444

L 60 P 31 SP. 3,8

0890436

L 90 P 31 SP. 3,8

0890446

L 60 P 31 SP. 3,8

0890438

L 90 P 31 SP. 3,8

0890448

mensola a isola

Completa di agganci

veneered shelf for island
complete of rack hooks



L 60 P 31 SP. 3,8

0890431

L 90 P 31 SP. 3,8

0890441

L 60 P 31 SP. 3,8

0890433

L 90 P 31 SP. 3,8

0890443

L 60 P 31 SP. 3,8

0890435

L 90 P 31 SP. 3,8

0890445

L 60 P 31 SP. 3,8

0890437

L 90 P 31 SP. 3,8

0890447

GRUPPOLUBE



MOBILI SIDE LACCATI

2023

GRUPPO **LUBE**





MOBILE DI FINITURA “SIDE”

“SIDE” FINISHING FURNITURE

COLORI STRUTTURA E DIVISORI LACCATI OPACHI CARCASS AND DIVIDERS MATT LACQUERED COLOURS

COLORI FREDDI COLD COLOURS



bianco assoluto (opz.740S)
absolute white

cenere (opz.9547)
ash

argilla (opz.9503)
clay

grigio bromo (opz.9533)
bromine grey

nero seppia (opz.7897)
cuttlefish ink

nebbia (opz.95F5)
fog

grigio traffico (opz.9511)
traffic grey



blu cristal (opz.8381)
crystal blue

nero (opz.7892)
black

COLORI CALDI HOT COLOURS



bianco caldo (opz.7401)
warm white

grigio kenya (opz.9501)
kenya grey

bistro (opz.9535)
bistro

cannella (opz.8893)
cinnamon

grigio reale (opz.95F3)
royal grey

grigio quarzo (opz.95F7)
quartz grey

azzurro nube (opz.8379)
cloud blue



conchiglia (opz.7403)
seashell

lino (opz.9513)
linen

creta (opz.9515)
clay

rosso persia (opz.8165)
persia red

giallo zafferano (opz.8253)
saffron yellow

verde bosco (opz.8468)
forest green

fumo (opz.9531)
smoke



grigio lava (opz.95F1)
lava grey

polvere (opz.9539)
dust

platino (opz.7773)
platinum

nocciola (opz.7775)
walnut

cuoio (opz.8897)
leather

tortora (opz.8993)
dove grey

rosso (opz.125S)
red



grigio piombo (opz.9537)
lead grey

carruba (opz.89L1)
carruba

azzurro ottanio (opz.8385)
teal blue

verde borneo (opz.8483)
borneo green

verde cinabro (opz.8481)
cinabro green

granato (opz.8633)
ruby red

giallo digione (opz.8257)
digione yellow



cotto (opz.8887)
cooked

verde celadon (opz.8485)
celadon green

COLORI DIVISORI VETRI GLASS DIVIDERS COLOURS



vetro satinato
satin glass

vetro bronzo
bronze glass

vetro fumè
fumè glass

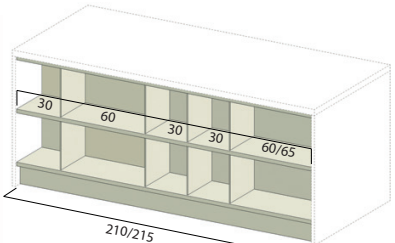
<p>Disponibile kit luce led "STRIP REEL" (vedere listino "Luci e dispositivi elettrici") Available led light kit "STRIP REEL" (see price list "Lights and electrical devices")</p>		COD.		
<p>mobile L 150/155 P 32,8 con ripiani sp.25 mm 8 vani e 6 divisori sp.10 mm furniture W 150/155 D 32,8 with shelves th.25 mm 8 compartments and 6 dividers th.10 mm</p>  <p>verso dx RH version</p>	<p>L 150 per isola for island</p> <p>H 72 E83672151/2</p> <p>H 75 E83675151/2</p> <p>H 84 E83684151/2</p>			
	<p>L 155 per penisola for peninsula</p> <p>H 72 E83672155/6</p> <p>H 75 E83675155/6</p> <p>H 84 E83684155/6</p>			
	<p>mag. divisori in vetro sp.8 mm surcharge glass dividers th.8 mm</p>			
	<p>mobile L 180/185 P 32,8 con ripiani sp.25 mm 10 vani e 8 divisori sp.10 mm furniture W 180/185 D 32,8 with shelves th.25 mm 10 compartments and 8 dividers th.10 mm</p>  <p>verso dx RH version</p>	<p>L 180 per isola for island</p> <p>H 72 E83672181/2</p> <p>H 75 E83675181/2</p> <p>H 84 E83684181/2</p>		
		<p>L 185 per penisola for peninsula</p> <p>H 72 E83672185/6</p> <p>H 75 E83675185/6</p> <p>H 84 E83684185/6</p>		
		<p>mag. divisori in vetro sp.8 mm surcharge glass dividers th.8 mm</p>		
		<p>mobile L 210/215 P 32,8 con ripiani sp.25 mm 10 vani e 8 divisori sp.10 mm furniture W 210/215 D 32,8 with shelves th.25 mm 10 compartments and 8 dividers th.10 mm</p>  <p>verso dx RH version</p>	<p>L 210 per isola for island</p> <p>H 72 E83672211/2</p> <p>H 75 E83675211/2</p> <p>H 84 E83684211/2</p>	
			<p>L 215 per penisola for peninsula</p> <p>H 72 E83672215/6</p> <p>H 75 E83675215/6</p> <p>H 84 E83684215/6</p>	
			<p>mag. divisori in vetro sp.8 mm surcharge glass dividers th.8 mm</p>	
			<p>mobile L 240/245 P 32,8 con ripiani sp.25 mm 10 vani e 8 divisori sp.10 mm furniture W 240/245 D 32,8 with shelves th.25 mm 10 compartments and 8 dividers th.10 mm</p>  <p>verso dx RH version</p>	<p>L 240 per isola for island</p> <p>H 72 E83672241/2</p> <p>H 75 E83675241/2</p> <p>H 84 E83684241/2</p>
<p>L 245 per penisola for peninsula</p> <p>H 72 E83672245/6</p> <p>H 75 E83675245/6</p> <p>H 84 E83684245/6</p>				
<p>mag. divisori in vetro sp.8 mm surcharge glass dividers th.8 mm</p>				

Disponibile kit luce led "STRIP REEL" (vedere listino "Luci e dispositivi elettrici")
 Available led light kit "STRIP REEL" (see price list "Lights and electrical devices")

COD.

mobile L 150/155 P 32,8 con ripiano sp.25 mm
4 vani e 3 divisori sp.10 mm

furniture W 150/155 D 32,8 with shelf th.25 mm
 4 compartments and 3 dividers th.10 mm

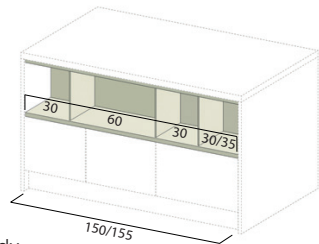

verso dx
 RH version

L 150 per isola
 for island

H 36	E83636151/2
H 37,5	E83637151/2
H 42	E83642151/2
H 48	E83648151/2

L 155 per penisola
 for peninsula

H 36	E83636155/6
H 37,5	E83637155/6
H 42	E83642155/6
H 48	E83648155/6

mag. divisori in vetro sp.8 mm
 surcharge glass dividers th.8 mm

mobile L 180/185 P 32,8 con ripiano sp.25 mm
5 vani e 4 divisori sp.10 mm

furniture W 180/185 D 32,8 with shelf th.25 mm
 5 compartments and 4 dividers th.10 mm

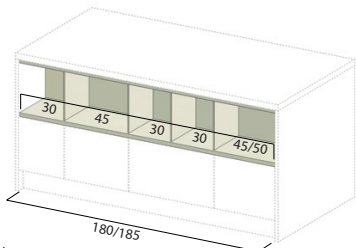

verso dx
 RH version

L 180 per isola
 for island

H 36	E83636181/2
H 37,5	E83637181/2
H 42	E83642181/2
H 48	E83648181/2

L 185 per penisola
 for peninsula

H 36	E83636185/6
H 37,5	E83637185/6
H 42	E83642185/6
H 48	E83648185/6

mag. divisori in vetro sp.8 mm
 surcharge glass dividers th.8 mm

mobile L 210/215 P 32,8 con ripiano sp.25 mm
5 vani e 4 divisori sp.10 mm

furniture W 210/215 D 32,8 with shelf th.25 mm
 5 compartments and 4 dividers th.10 mm

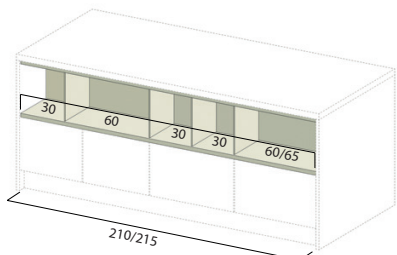

verso dx
 RH version

L 210 per isola
 for island

H 36	E83636211/2
H 37,5	E83637211/2
H 42	E83642211/2
H 48	E83648211/2

L 215 per penisola
 for peninsula

H 36	E83636215/6
H 37,5	E83637215/6
H 42	E83642215/6
H 48	E83648215/6

mag. divisori in vetro sp.8 mm
 surcharge glass dividers th.8 mm

mobile L 240/245 P 32,8 con ripiano sp.25 mm
5 vani e 4 divisori sp.10 mm

furniture W 240/245 D 32,8 with shelves th.25 mm
 5 compartments and 4 dividers th.10 mm

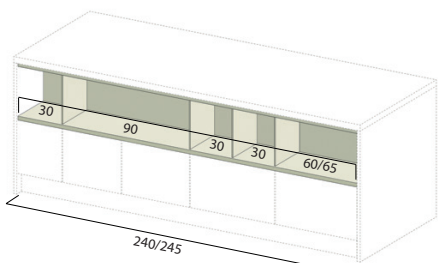

verso dx
 RH version

L 240 per isola
 for island

H 36	E83636241/2
H 37,5	E83637241/2
H 42	E83642241/2
H 48	E83648241/2

L 245 per penisola
 for peninsula

H 36	E83636245/6
H 37,5	E83637245/6
H 42	E83642245/6
H 48	E83648245/6

mag. divisori in vetro sp.8 mm
 surcharge glass dividers th.8 mm