

GRUPPOLUBE



**GENIUS-K**  
2023

04	● ●	FLAP	PIANO D'APPOGGIO ESTRAIBILE CON PORTA POSATE PULL-OUT WORKTOP WITH CUTLERY TRAY
08	● ●	LUNCH	PIANO ESTRAIBILE DA FRONTALE PULL-OUT WORKTOP FROM A FRONT PANEL
12	● ●	DUAL	PIANO ESTRAIBILE DA FRONTALE CON PORTA POSATE E CONTENITORE PULL-OUT WORKTOP FROM A FRONT PANEL WITH CUTLERY TRAY AND CONTAINER
16	● ●	SKIP	PIANO ESTRAIBILE A FILO RIPIANO PULL-OUT WORKTOP ALLIGNED WITH SHELF
22	●	PARTY	TAVOLO ESTRAIBILE DA FRONTALE CON SOSTEGNO PULL-OUT TABLE FROM FRONT PANEL WITH SUPPORT
26	●	DESK	PIANO ESTRAIBILE DA FRONTALE PULL-OUT WORKTOP FROM FRONT PANEL
32	●	SLICER	VANO ATTREZZATO CON SERRANDINA EQUIPPED COMPARTMENT WITH SHUTTER
36	● ●	SLICER BOX	PIANO ESTRAIBILE PULL-OUT WORKTOP
40	● ●	SLICER BOX DUSTBIN	TAGLIERE ESTRAIBILE CON PATTUMIERA PULL-OUT CUTTING BOARD WITH DUSTBIN
44	●	EXTRA	VANO ATTREZZATO CON SERRANDINA EQUIPPED COMPARTMENT WITH SHUTTER
48	●	ROLL	MOBILE CON SERRANDINA FURNITURE WITH SHUTTER
52	● ●	FLUX	TAVOLO ESTRAIBILE CON GAMBE PULL-OUT TABLE WITH LEGS
58	●	VOILA'	PIANO ESTRAIBILE CON GAMBE PULL-OUT WORKTOP WITH LEGS
62	●	DAIS	PEDANA ESTRAIBILE CON CASSETTO PULL-OUT PLATFORM WITH DRAWER
66	● ●	SLED	TAVOLO ESTRAIBILE DA CASSETTO PULL-OUT TABLE FROM DRAWER
70	● ●	BOW	ASSE DA STIRO ESTRAIBILE PULL-OUT IRONING BOARD
74	●	OPEN	MOBILE ATTREZZATO CON PIANO VASISTAS EQUIPPED FURNITURE WITH FLAP DOOR
78	●	BOX WORK	PARETE ATTREZZATA CON PIANO ESTRAIBILE EQUIPPED WALL WITH PULL-OUT WORKTOP

86	●	GLIDE	PIANO SCORREVOLE SU TOP SLIDING TABLE ON WORKTOP
90	● ●	CORNER	PIANO SCORREVOLE SU TOP SLIDING TABLE ON WORKTOP
94	●	QUICK	PIANO SCORREVOLE SU TOP SLIDING TABLE ON WORKTOP
98	●	SWIFT	PIANO SCORREVOLE SU TOP SLIDING TABLE ON WORKTOP
102	●	LINE-N	PIANO SCORREVOLE SU TOP SLIDING TABLE ON WORKTOP

Sistemi estraibili  
Pull-out systems

# Flap

PIANO D'APPOGGIO ESTRAIBILE CON PORTA POSATE  
PULL-OUT WORKTOP WITH CUTLERY TRAY

BASI - BASE UNITS ●

ISOLA/PENISOLA - ISLAND/PENINSULA ●



# “FLAP” - MODULARITÀ DELLE BASI E DETTAGLI FUNZIONAMENTO

## “FLAP” - BASE UNITS MODULARITY AND OPERATION DETAILS

### MODULARITÀ DELLE BASI - BASE UNITS MODULARITY

#### • NECK/LUX - FRONTALE SINGOLO - SINGLE FRONT PANEL

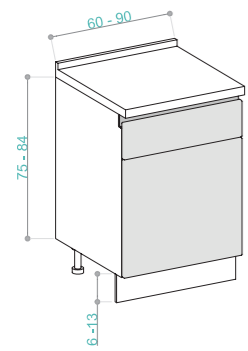

##### ZOCCOLO H 13 - PLINTH H 13

FRONTALE	H 169
ANTA	H 545 (push pull)
FRONT PANEL	H 169
DOOR	H 545 (push pull)
L 60	G4231601/2
L 90	G4231900

##### ZOCCOLO H 6 - PLINTH H 6

FRONTALE	H 192
ANTA	H 612 (push pull)
FRONT PANEL	H 169
DOOR	H 612 (push pull)
L 60	GB230601/2
L 90	GB230900

#### • NECK/LUX - FRONTALE DOPPIO - DOUBLE FRONT PANEL

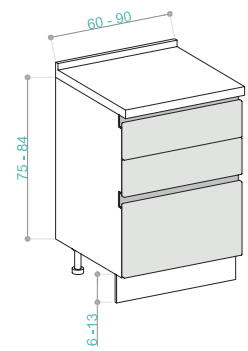

##### ZOCCOLO H 13 - PLINTH H 13

FRONTALE	H 169
CASSETTO	H 169
CESTONE	H 342
FRONT PANEL	H 169
DRAWER	H 169
DEEP DRAWER	H 342
L 60	G4234600
L 90	G4234900

##### ZOCCOLO H 6 - PLINTH H 6

FRONTALE	H 192
CASSETTO	H 192
CESTONE	H 387
FRONT PANEL	H 192
DRAWER	H 192
DEEP DRAWER	H 387
L 60	GB234600
L 90	GB234900

#### • BRIDGE/HEAD - FRONTALE SINGOLO - SINGLE FRONT PANEL

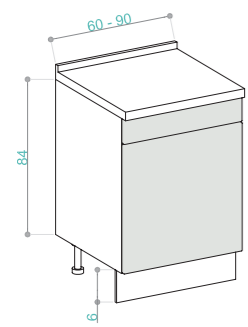

##### ZOCCOLO H 13 - PLINTH H 13

NON DISPONIBILE  
UNAVAILABLE

##### ZOCCOLO H 6 - PLINTH H 6

FRONTALE	H 237
ANTA	H 597
FRONT PANEL	H 237
DOOR	H 597
L 60	EB230601/2
L 90	EB230900

#### • BRIDGE/HEAD - DOPPIO FRONTALE - DOUBLE FRONT PANEL

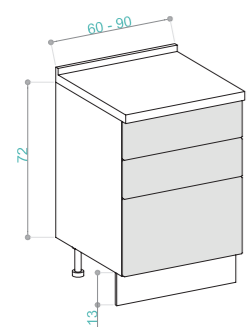

##### ZOCCOLO H 13 - PLINTH H 13

FRONTALE	H 177
CASSETTO	H 177
CESTONE	H 357
FRONT PANEL	H 177
DRAWER	H 177
DEEP DRAWER	H 357
L 60	E4235600
L 90	E4235900

##### ZOCCOLO H 6 - PLINTH H 6

NON DISPONIBILE  
UNAVAILABLE

### DETTAGLI FUNZIONAMENTO - OPERATION DETAILS



Colore piano d'appoggio: Visone - Worktop colour: Mink



# “FLAP” - INGOMBRI E RIFERIMENTI VERSIONI

## “FLAP” - TECHNICAL DIMENSIONS AND VERSIONS

N.B.: posizionare ad almeno 5 cm dalla parete laterale  
NOTE: place at 5 cm from the side wall

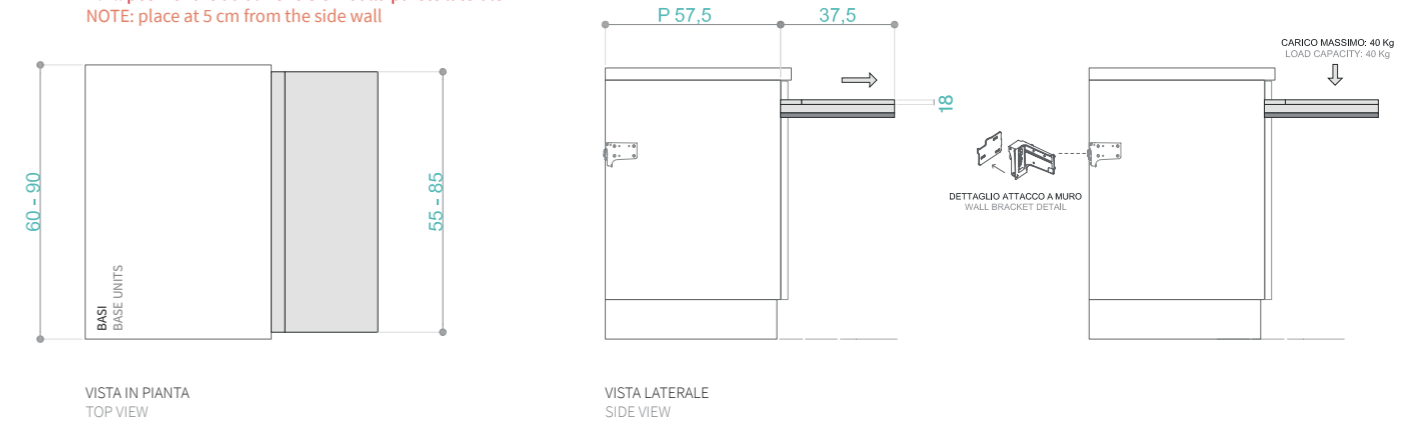

DESCRIZIONE MODELLO  
MODEL DESCRIPTION

VERSIONE  
VERSION

DIMENSIONE BASI  
BASE UNITS DIMENSION

#### PIANO D'APPOGGIO ESTRAIBILE CON PORTA POSATE

Completo di meccanismo per lo scorrimento

Gola  
Finger rail

60 - 90

Finiture: piano in melaminico disponibile nei colori come struttura.  
Porta posate realizzato in faggio listellare fresato.

(Neck-Lux)

Note: carico massimo supportato 40 kg (uniformemente distribuiti)

#### PULL-OUT WORKTOP WITH CUTLERY TRAY

Complete with sliding mechanism

Maniglia  
Handle

60 - 90

Finishes: worktop available in melamine same finish as carcass.  
Cutlery tray are made in milled blockboard beech.

(Bridge-Head)

Note: load capacity 40 kg (evenly distributed)

N.B.: LA BASE DEVE ESSERE ANCORATA OBBLIGATORIAMENTE A MURO TRAMITE ATTACCAGGIE IN DOTAZIONE. NON DISPONIBILE PER FUORI MISURA.  
NOTE: THE BASE UNIT MUST NECESSARILY BE ANCHORED TO THE WALL USING THE SUPPLIED HANGERS. CUSTOM SIZE NOT AVAILABLE.

# Lunch

PIANO ESTRAIBILE DA FRONTALE  
PULL-OUT WORKTOP FROM FRONT PANEL

BASI - BASE UNITS ●

ISOLA/PENISOLA - ISLAND/PENINSULA ●



# “LUNCH” - MODULARITÀ DELLE BASI E DETTAGLI FUNZIONAMENTO

## “LUNCH” - BASE UNITS MODULARITY AND OPERATION DETAILS

### MODULARITÀ DELLE BASI - BASE UNITS MODULARITY

#### NECK/LUX - FRONTALE SINGOLO - SINGLE FRONT PANEL

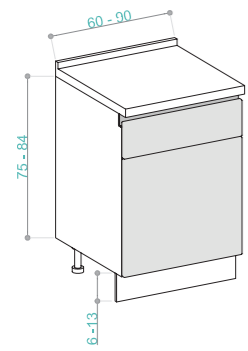

##### ZOCCOLO H 13 - PLINTH H 13

FRONTALE H 169  
 ANTA H 545 (push pull)  
 FRONT PANEL H 169  
 DOOR H 545 (push pull)  
 L 60 G4231601/2  
 L 90 G4231900

##### ZOCCOLO H 6 - PLINTH H 6

FRONTALE H 192  
 ANTA H 612 (push pull)  
 FRONT PANEL H 192  
 DOOR H 612 (push pull)  
 L 60 GB230601/2  
 L 90 GB230900

#### NECK/LUX - FRONTALE DOPPIO - DOUBLE FRONT PANEL

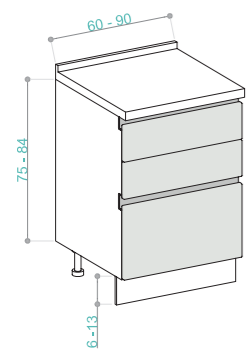

##### ZOCCOLO H 13 - PLINTH H 13

FRONTALE H 169  
 CASSETTO H 169  
 CESTONE H 342  
 FRONT PANEL H 169  
 DRAWER H 169  
 DEEP DRAWER H 342  
 L 60 G4234600  
 L 90 G4234900

##### ZOCCOLO H 6 - PLINTH H 6

FRONTALE H 192  
 CASSETTO H 192  
 CESTONE H 342  
 FRONT PANEL H 192  
 DRAWER H 192  
 DEEP DRAWER H 342  
 L 60 GB234600  
 L 90 GB234900

#### BRIDGE/HEAD - FRONTALE SINGOLO - SINGLE FRONT PANEL

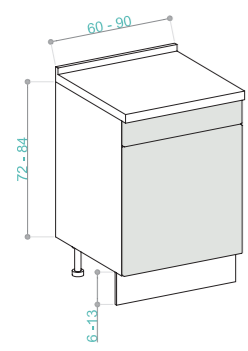

##### ZOCCOLO H 13 - PLINTH H 13

FRONTALE H 117  
 ANTA H 597  
 FRONT PANEL H 117  
 DOOR H 597  
 L 60 E4232601/2  
 L 90 E4232900

##### ZOCCOLO H 6 - PLINTH H 6

FRONTALE H 237  
 ANTA H 597  
 FRONT PANEL H 237  
 DOOR H 597  
 L 60 EB230601/2  
 L 90 EB230900

#### BRIDGE/HEAD - DOPPIO FRONTALE - DOUBLE FRONT PANEL

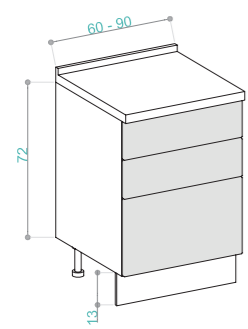

##### ZOCCOLO H 13 - PLINTH H 13

FRONTALE H 177  
 CASSETTO H 177  
 CESTONE H 357  
 FRONT PANEL H 177  
 DRAWER H 177  
 DEEP DRAWER H 357  
 L 60 E4235600  
 L 90 E4235900

##### ZOCCOLO H 6 - PLINTH H 6

NON DISPONIBILE  
 UNAVAILABLE

### DETTAGLI FUNZIONAMENTO - OPERATION DETAILS



Colore piano: Lavagna - Worktop colour: Slate Gray



# “LUNCH” - INGOMBRI E RIFERIMENTI VERSIONI

## “LUNCH” - TECHNICAL DIMENSIONS AND VERSIONS

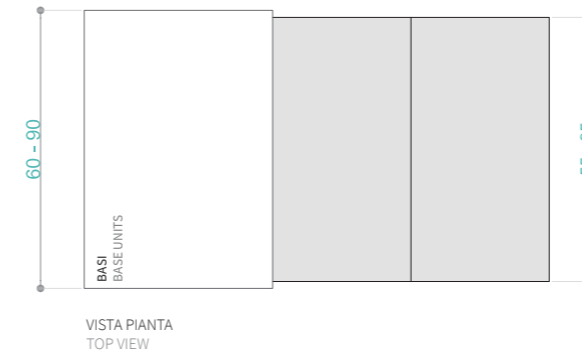

VISTA PIANTA  
 TOP VIEW

N.B.: posizionare ad almeno 5 cm dalla parete laterale  
 NOTE: place at 5 cm from the side wall

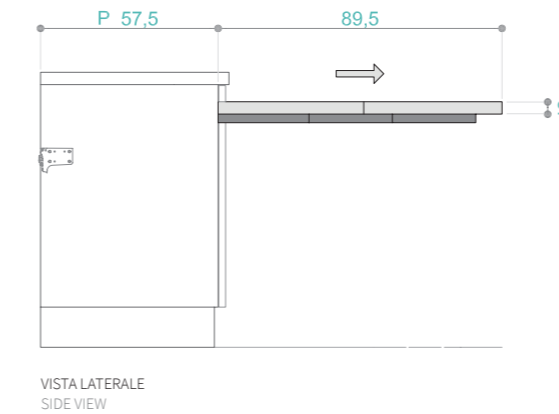

VISTA LATERALE  
 SIDE VIEW

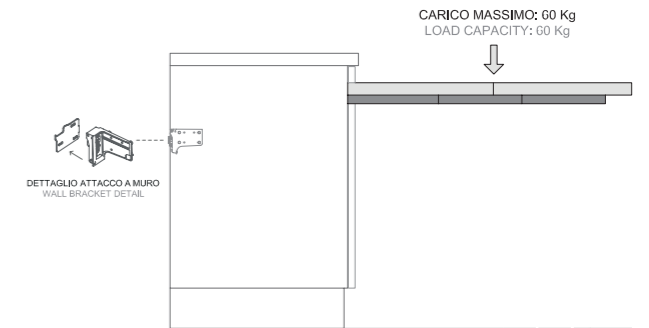

DESCRIZIONE MODELLO  
 MODEL DESCRIPTION

VERSIONE  
 VERSION

DIMENSIONE BASI  
 BASE UNITS DIMENSION

#### PIANO ESTRAIBILE DA FRONTALE

Completo di meccanismo per lo scorrimento

Gola  
 Finger rail  
 (Neck-Lux)

60 - 90

Finiture: piano in melaminico disponibile nei colori come struttura.

Note: carico massimo supportato 60 kg (uniformemente distribuiti)

#### PULL-OUT WORKTOP FROM FRONT PANEL

Complete with sliding mechanism

Maniglia  
 Handle  
 (Bridge-Head)

60 - 90

Finishes: worktop available in melamine same finish as carcass.

Note: load capacity 60 kg (evenly distributed)

N.B.: LA BASE DEVE ESSERE ANCORATA OBBLIGATORIAMENTE A MURO TRAMITE ATTACCCAGLIE IN DOTAZIONE. NON DISPONIBILE PER FUORI MISURA.  
 NOTE: THE BASE UNIT MUST NECESSARILY BE ANCHORED TO THE WALL USING THE SUPPLIED HANGERS. CUSTOM SIZE NOT AVAILABLE.

# Dual

PIANO ESTRAIBILE DA FRONTALE CON PORTA POSATE E CONTENITORE  
PULL-OUT WORKTOP FROM A FRONT PANLE WITH CUTLERY TRAY AND COMPARTMENT

BASI - BASE UNITS ●

ISOLA/PENISOLA - ISLAND/PENINSULA ●





“DUAL” - MODULARITÀ DELLE BASI E DETTAGLI FUNZIONAMENTO  
 “DUAL” - BASE UNITS MODULARITY AND OPERATION DETAILS

MODULARITÀ DELLE BASI - BASE UNITS MODULARITY

• **NECK/LUX - FRONTALE SINGOLO - SINGLE FRONT PANEL**

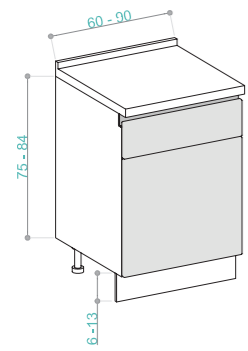

**ZOCCOLO H 13 - PLINTH H 13**

FRONTALE H 222  
 ANTA H 492 (push pull)  
 FRONT PANEL H 222  
 DOOR H 492 (push pull)  
 L 60 G4235601/2  
 L 90 G4235900

**ZOCCOLO H 6 - PLINTH H 6**

FRONTALE H 192  
 ANTA H 612 (push pull)  
 FRONT PANEL H 192  
 DOOR H 612 (push pull)  
 L 60 GB235601/2  
 L 90 GB235900

• **NECK/LUX - FRONTALE DOPPIO - DOUBLE FRONT PANEL**

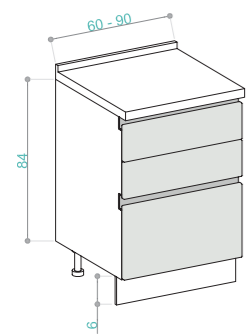

**ZOCCOLO H 13 - PLINTH H 13**

NON DISPONIBILE  
 UNAVAILABLE

**ZOCCOLO H 6 - PLINTH H 6**

FRONTALE H 192  
 CASSETTO H 192  
 CESTONE H 387  
 FRONT PANEL H 192  
 DRAWER H 192  
 DEEP DRAWER H 387  
 L 60 GB233600  
 L 90 GB233900

DETTAGLI FUNZIONAMENTO - OPERATION DETAILS



Colore piano: Listellare faggio - Worktop colour: Beech wood strips

• **BRIDGE/HEAD - FRONTALE SINGOLO - SINGLE FRONT PANEL**

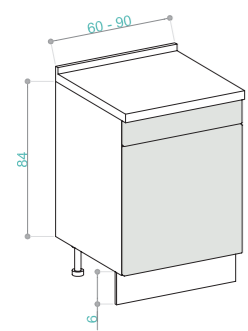

**ZOCCOLO H 13 - PLINTH H 13**

NON DISPONIBILE  
 UNAVAILABLE

**ZOCCOLO H 6 - PLINTH H 6**

FRONTALE H 237  
 ANTA H 597  
 FRONT PANEL H 237  
 DOOR H 597  
 L 60 EB235601/2  
 L 90 EB235900

• **BRIDGE/HEAD - DOPPIO FRONTALE - DOUBLE FRONT PANEL**

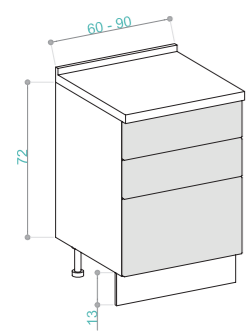

**ZOCCOLO H 13 - PLINTH H 13**

FRONTALE H 177  
 CASSETTO H 177  
 CESTONE H 357  
 FRONT PANEL H 177  
 DRAWER H 177  
 DEEP DRAWER H 357  
 L 60 E4231600  
 L 90 E4231900

**ZOCCOLO H 6 - PLINTH H 6**

NON DISPONIBILE  
 UNAVAILABLE



“DUAL” - INGOMBRI E RIFERIMENTI LISTINO  
 “DUAL” - TECHNICAL DIMENSIONS AND PRICE LIST

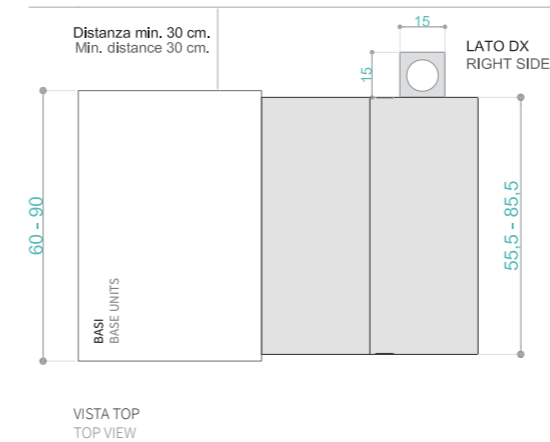

N.B.: posizionare ad almeno 5 cm dalla parete laterale  
 NOTE: place at 5 cm from the side wall

VISTA TOP  
 TOP VIEW

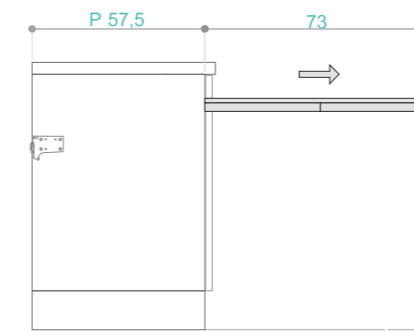

VISTA LATERALE  
 SIDE VIEW

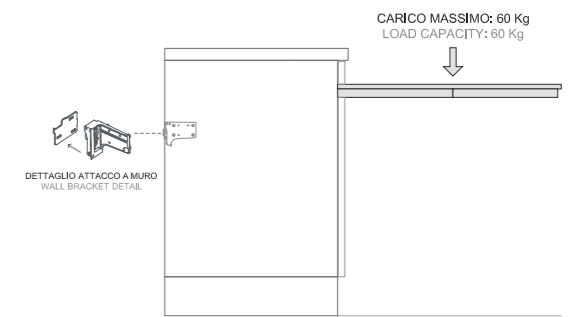

DESCRIZIONE MODELLO  
 MODEL DESCRIPTION

VERSIONE  
 VERSION

DIMENSIONE BASI  
 BASE UNITS DIMENSION

**PIANO ESTRAIBILE DA FRONTALE CON PORTA POSATE E CONTENITORE**

Completo di meccanismo per lo scorrimento

Gola  
 Finger rail  
 (Neck-Lux)

60 - 90

Finiture: ripiano in lamellare con retro in betacryl.  
 Porta posate realizzato in faggio listellare fresato.

Note: carico massimo supportato 60 kg (uniformemente distribuiti)

**PULL-OUT WORKTOP FROM A FRONT PANEL WITH CUTLERY TRAY AND CONTAINER**

Complete with sliding mechanism

Maniglia  
 Handle  
 (Bridge-Head)

60 - 90

Finishes: blockboard beech worktop covered on the back with betacryl.  
 Cutlery tray is made by milled blockboard beech.

Note: load capacity 60 kg (evenly distributed)

N.B.: LA BASE DEVE ESSERE ANCORATA OBBLIGATORIAMENTE A MURO TRAMITE ATTACCAGGIE IN DOTAZIONE. NON DISPONIBILE PER FUORI MISURA.  
 NOTE: THE BASE UNIT MUST NECESSARILY BE ANCHORED TO THE WALL USING THE SUPPLIED HANGERS. CUSTOM SIZE NOT AVAILABLE.

# Skip Nook - Suspended

PIANO ESTRAIBILE A FILO RIPIANO  
PULL-OUT WORKTOP ALLIGNED WITH SHELF

COLONNE - COLUMNS ●

LIVING ●



“SKIP-N” - COLONNE NOOK - CARATTERISTICHE TECNICHE GUIDE  
 “SKIP-N” - NOOK COLUMNS - GUIDES TECHNICAL SPECIFICATIONS

RIFERIMENTI DIMENSIONALI - OVERALL DIMENSIONS

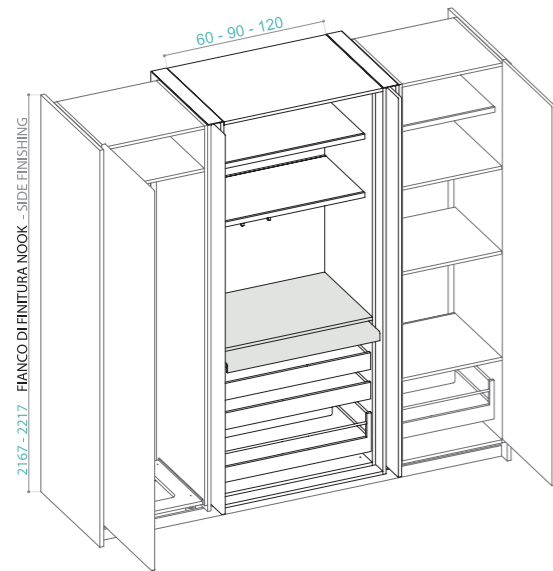

DETTAGLI FUNZIONAMENTO - OPERATION DETAILS



Finiture: Laminato Calacatta (sopra) Acciaio inox (sotto)  
 Worktop finishes: Calacatta laminate (up) Stainless steel (down)



“SKIP-N”- INGOMBRI E RIFERIMENTI LISTINO - COLONNE NOOK  
 “SKIP-N”- TECHNICAL DIMENSIONS AND PRICE LIST - NOOK COLUMNS

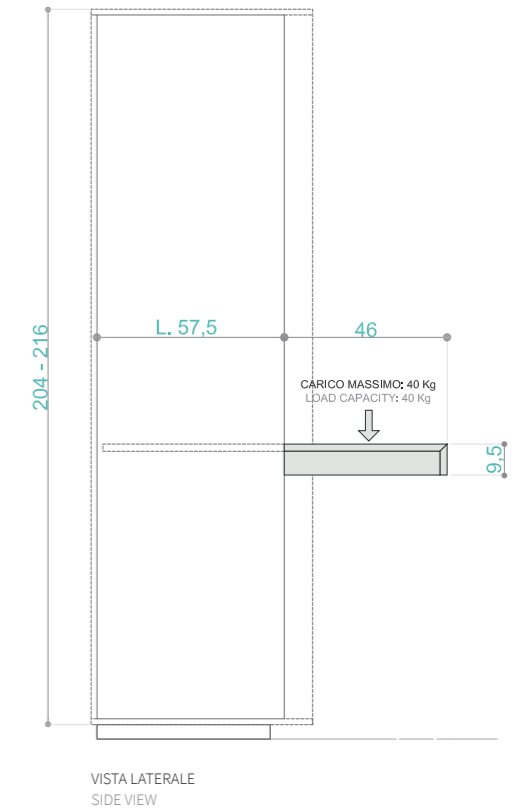
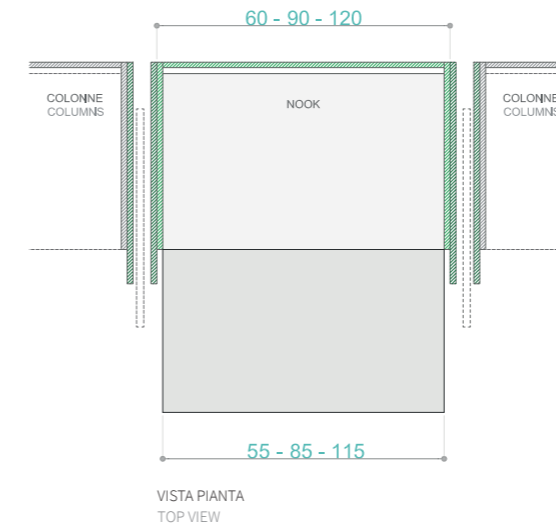

DESCRIZIONE MODELLO  
 MODEL DESCRIPTION

**PIANO ESTRAIBILE FILO RIPIANO**  
 Completo di meccanismo per lo scorrimento

Finiture: rivestimento piano disponibile in laminato finitura Calacatta e acciaio inox.

Note: carico massimo supportato 40 kg (uniformemente distribuiti)

**PULL-OUT WORKTOP ALLIGNED WITH SHELF**  
 Complete with sliding mechanism

Finishes: worktop finish are available in laminate Calacatta finish and stainless steel.

Note: load capacity 40 kg (evenly distributed)

FINITURA ESTERNA  
 EXTERNAL FINISH

Laminato Calacatta  
 Acciaio inox

Calacatta laminate  
 Stainless steel

DIMENSIONE COLONNE  
 COLUMNS DIMENSION

60-90-120

N.B.: IL MODULO DEVE ESSERE ANCORATO OBBLIGATORIAMENTE A MURO TRAMITE ATTACCAGLIE IN DOTAZIONE. NON DISPONIBILE PER FUORI MISURA.  
 NOTE: THE COLUMNS MUST NECESSARILY BE ANCHORED TO THE WALL USING THE SUPPLIED HANGERS. CUSTOM SIZE NOT AVAILABLE.

# “SKIP-S” - MODULARITÀ DELLE BASI E DETTAGLI FUNZIONAMENTO

## “SKIP-S” - BASE UNITS MODULARITY AND OPERATION DETAILS

### MODULARITÀ DELLE BASI - BASE UNITS MODULARITY

#### • NECK/LUX - FRONTALE SINGOLO - SINGLE FRONT PANEL

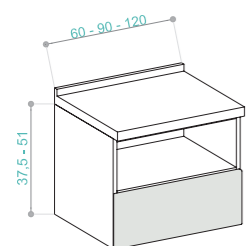

##### H 37,5 SOSPESA - HANGING

VANO H 115  
FRONTALE H 210  
COMPARTMENT H 115  
FRONT PANEL H 210

L 60 GBL27206  
L 90 GBL27209  
L 120 GBL27120

##### H 51 SOSPESA - HANGING

VANO H 250  
FRONTALE H 210  
COMPARTMENT H 250  
FRONT PANEL H 210

L 60 GBL37206  
L 90 GBL37209  
L 120 GBL37120

#### • BRIDGE/HEAD - FRONTALE SINGOLO - SINGLE FRONT PANEL

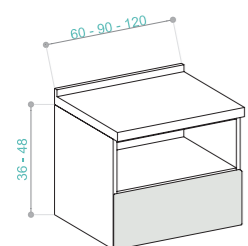

##### H 36 SOSPESA - HANGING

VANO H 100  
FRONTALE H 210  
COMPARTMENT H 100  
FRONT PANEL H 210

L 60 EBL27206  
L 90 EBL27209  
L 120 EBL27120

##### H 48 SOSPESA - HANGING

VANO H 220  
FRONTALE H 210  
COMPARTMENT H 220  
FRONT PANEL H 210

L 60 EBL37206  
L 90 EBL37209  
L 120 EBL37120

### DETTAGLI FUNZIONAMENTO - OPERATION DETAILS



Colore ripiano: Lavagna - Worktop colour: Slate Gray



# “SKIP-S” - INGOMBRI E RIFERIMENTI VERSIONI

## “SKIP-S” - TECHNICAL DIMENSIONS AND VERSIONS

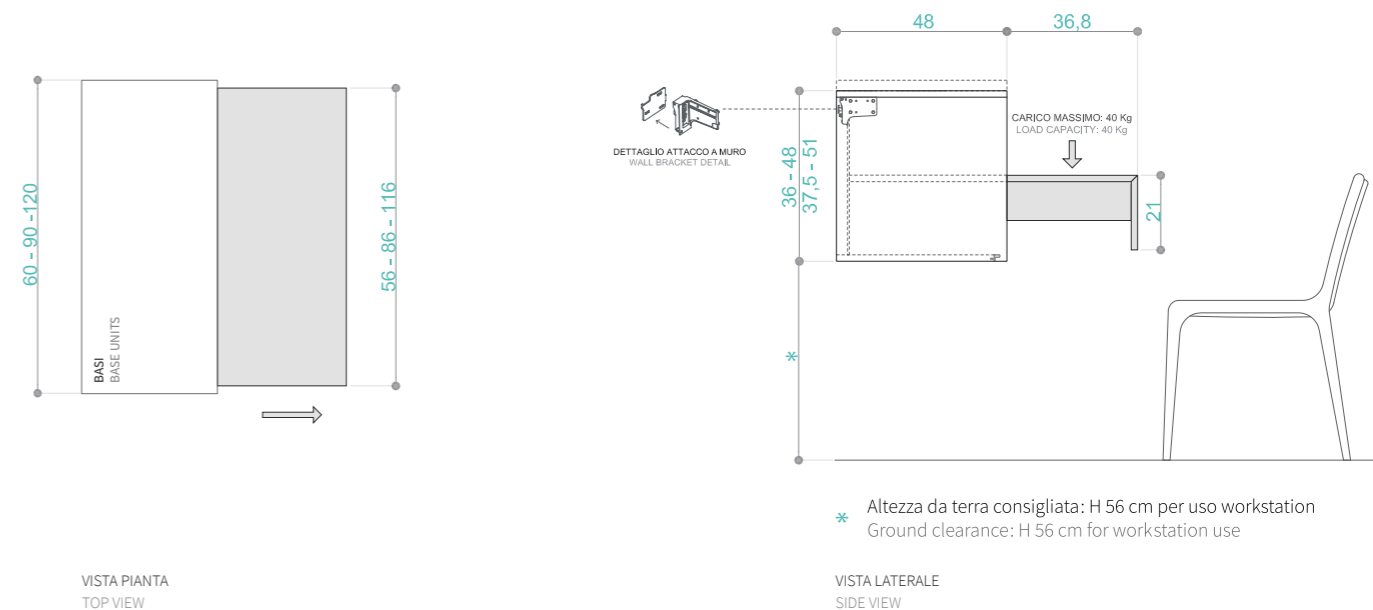

DESCRIZIONE MODELLO - VERSIONE PER BASI LIVING P 48  
MODEL DESCRIPTION - VERSION FOR LIVING BASE UNITS D 48

VERSIONE  
VERSION

DIMENSIONE BASI  
BASE UNITS DIMENSION

#### PIANO ESTRAIBILE FILO RIPIANO

Completo di meccanismo per lo scorrimento

Gola  
Finger rail

60 - 90 - 120

Finiture: rivestimento piano disponibile in melaminico nei colori come struttura.

(Neck-Lux)

Note: carico massimo supportato 40 kg (uniformemente distribuiti)

#### PULL-OUT WORKTOP ALLIGNED WITH SHELF

Complete with sliding mechanism

Finishes: worktop finish available in melamine in the same colours as carcass.

Maniglia  
Handle

60 - 90 - 120

Note: load capacity 40 kg (evenly distributed)

(Bridge-Head)

N.B.: LA BASE DEVE ESSERE ANCORATA OBBLIGATORIAMENTE A MURO TRAMITE ATTACCHIE IN DOTAZIONE. NON DISPONIBILE PER FUORI MISURA.  
NOTE: THE BASE UNIT MUST NECESSARILY BE ANCHORED TO THE WALL USING THE SUPPLIED HANGERS. CUSTOM SIZE NOT AVAILABLE.

# Party

TAVOLO ESTRAIBILE DA FRONTALE CON SOSTEGNO  
PULL-OUT TABLE FROM FRONT PANEL WITH SUPPORT

BASI - BASE UNITS ●



# “PARTY” - MODULARITÀ DELLE BASI E FUNZIONAMENTO

## “PARTY” - BASE UNITS MODULARITY AND OPERATION DETAILS

### MODULARITÀ DELLE BASI - BASE UNITS MODULARITY

#### BRIDGE/HEAD - DOPPIO FRONTALE - DOUBLE FRONT PANEL

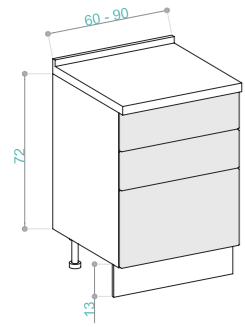

#### ZOCCOLO H 13 - PLINTH H 13

FRONTALE H 180  
CASSETTO H 180  
CESTONE H 360  
FRONT PANEL H 180  
DRAWER H 180  
DEEP DRAWER H 360

L 60 E4234600  
L 90 E4234900

#### ZOCCOLO H 6 - PLINTH H 6

NON DISPONIBILE  
UNAVAILABLE

### DETTAGLI FUNZIONAMENTO - OPERATION DETAILS



Colore ripiano: Bianco - Worktop colour: White



# “PARTY” - INGOMBRI E RIFERIMENTI LISTINO

## “PARTY” - TECHNICAL DIMENSIONS AND PRICE LIST

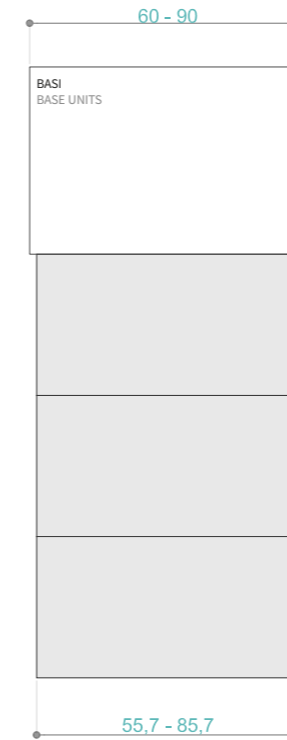

N.B.: posizionare ad almeno 5 cm dalla parete laterale  
NOTE: place at 5 cm from the side wall

VISTA PIANTA  
TOP VIEW

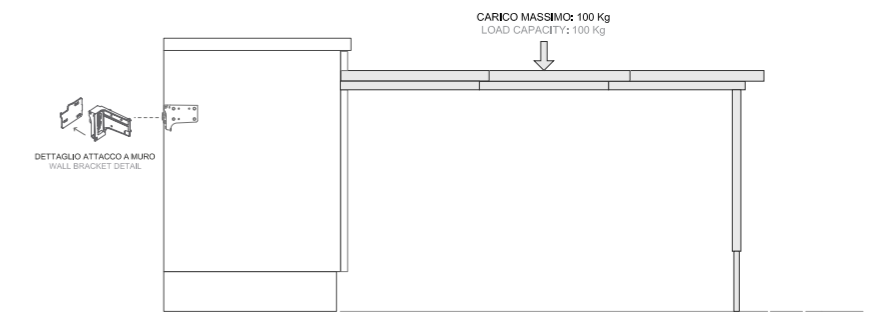
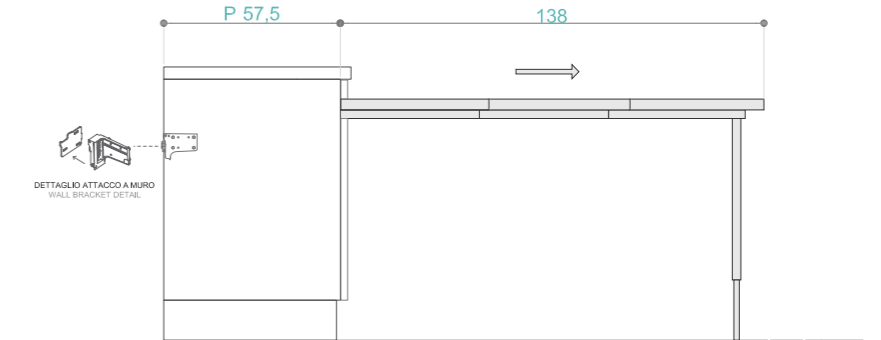

VISTA LATERALE  
SIDE VIEW

DESCRIZIONE MODELLO  
MODEL DESCRIPTION

VERSIONE  
VERSION

DIMENSIONE BASI  
BASE UNITS DIMENSION

**TAVOLO ESTRAIBILE DA FRONTALE CON SOSTEGNO TELESCOPICO**  
Completo di meccanismo per lo scorrimento

Maniglia  
Handle

60

Finiture piano: disponibile in melaminico nei colori come struttura.  
Finitura sostegno: inox bronzino

(Bridge-Head)

90

Note: carico massimo supportato 100 kg (uniformemente distribuiti)

**PULL-OUT TABLE FROM FRONT PANEL WITH TELESCOPIC SUPPORT**  
Complete with sliding mechanism

Worktop finishes: available in melamine same colours as carcass  
Support finish: bronzed stainless steel

Note: load capacity 100 kg (evenly distributed)

N.B.: LA BASE DEVE ESSERE ANCORATA OBBLIGATORIAMENTE A MURO TRAMITE ATTACCAGGIE IN DOTAZIONE. NON DISPONIBILE PER FUORI MISURA.  
NOTE: THE BASE UNIT MUST NECESSARILY BE ANCHORED TO THE WALL USING THE SUPPLIED HANGERS. CUSTOM SIZE NOT AVAILABLE.

# Desk

PIANO ESTRAIBILE DA FRONTALE  
PULL-OUT WORKTOP FROM FRONT PANEL

LIVING ●



# “DESK” - MODULARITÀ DELLE BASI E DETTAGLI FUNZIONAMENTO

## “DESK” - BASE UNITS MODULARITY AND OPERATION DETAILS

### MODULARITÀ DELLE BASI - BASE UNITS MODULARITY

#### • NECK/LUX - DOPPIO FRONTALE - DOUBLE FRONT PANEL

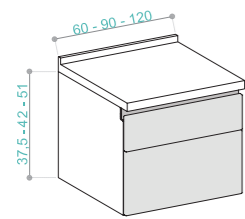

##### H 37,5 SOSPESA - HANGING

FRONTALE H 169  
CASSETTO H 169  
FRONT PANEL H 169  
DRAWER H 169

L 60 GBL27360  
L 90 GBL27390  
L 120 GBL27420

##### H 42 SOSPESA - HANGING

FRONTALE H 192  
CASSETTO H 192  
FRONT PANEL H 192  
DRAWER H 192

L 60 GBL28360  
L 90 GBL28390  
L 120 GBL28420

##### H 51 SOSPESA - HANGING

FRONTALE H 169  
CESTONE H 305  
FRONT PANEL H 169  
DEEP DRAWER H 305

L 60 GBL37360  
L 90 GBL37390  
L 120 GBL37420

N.B.: nelle versioni Neck e Lux il cassetto/cestone inferiore ha sempre l'apertura con presa su fondo  
Note: opening with grip bottom for lower drawer/deep drawer in the Neck and Lux versions

### DETTAGLI FUNZIONAMENTO - OPERATION DETAILS



Colore ripiano: Bianco - Worktop colour: White

#### • BRIDGE/HEAD - FRONTALE SINGOLO - SINGLE FRONT PANEL

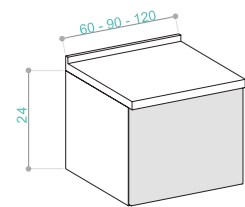

##### H 24 SOSPESA - HANGING

FRONTALE H 237  
FRONT PANEL H 237

L 60 EBL17360  
L 90 EBL17390  
L 120 EBL17420

#### • BRIDGE/HEAD - DOPPIO FRONTALE - DOUBLE FRONT PANEL

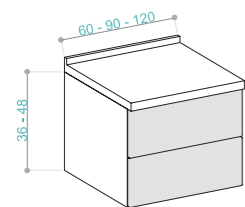

##### H 36 SOSPESA - HANGING

FRONTALE H 177  
CASSETTO H 177  
FRONT PANEL H 177  
DRAWER H 177

L 60 EBL27360  
L 90 EBL27390  
L 120 EBL27420

##### H 48 SOSPESA - HANGING

FRONTALE H 237  
CASSETTO H 237  
FRONT PANEL H 237  
DRAWER H 237

L 60 EBL37360  
L 90 EBL37390  
L 120 EBL37420



# “DESK” - INGOMBRI E RIFERIMENTI LISTINO

## “DESK” - TECHNICAL DIMENSIONS AND PRICE LIST

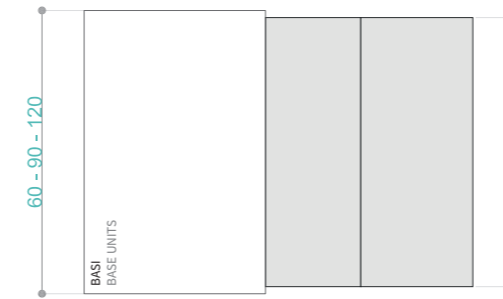

VISTA PIANTA  
TOP VIEW

N.B.: posizionare ad almeno 5 cm dalla parete laterale  
NOTE: place at 5 cm from the side wall

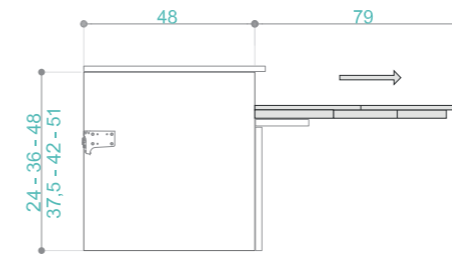

VISTA LATERALE  
SIDE VIEW

\* Altezza piano consigliata: H 75 cm per uso workstation  
Height top recommended: H 75 cm for workstation use  
\*\* Altezza da terra consigliata: H 82 cm per uso workstation  
Ground clearance: H 82 cm for workstation use

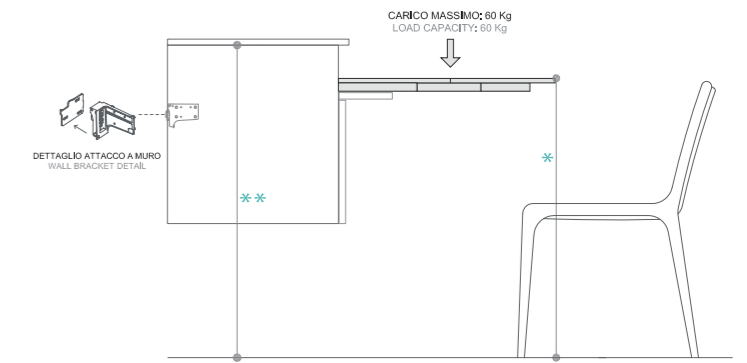

DESCRIZIONE MODELLO  
MODEL DESCRIPTION

VERSIONE  
VERSION

DIMENSIONE BASI  
BASE UNITS DIMENSION

#### PIANO ESTRAIBILE DA FRONTALE

Completo di meccanismo per lo scorrimento

Gola  
Finger rail

60 - 90 - 120

Finiture: piano in melaminico disponibile nei colori come struttura.

(Neck-Lux)

Note: carico massimo supportato 60 kg (uniformemente distribuiti)

#### PULL-OUT WORKTOP FROM FRONT PANEL

Complete with sliding mechanism

Maniglia  
Handle

60 - 90 - 120

Finishes: melamine worktop available in the same colours as carcass

(Bridge-Head)

Note: load capacity 60 kg (evenly distributed)

N.B.: LA BASE DEVE ESSERE ANCORATA OBBLIGATORIAMENTE A MURO TRAMITE ATTACCAGLIE IN DOTAZIONE. NON DISPONIBILE PER FUORI MISURA.  
NOTE: THE BASE UNIT MUST NECESSARILY BE ANCHORED TO THE WALL USING THE SUPPLIED HANGERS. CUSTOM SIZE NOT AVAILABLE.



# Slicer

VANO ATTREZZATO CON SERRANDINA  
EQUIPPED COMPARTMENT WITH SHUTTER

COLONNE - COLUMNS ●



# “SLICER” - MODULARITÀ DELLE COLONNE E DETTAGLI FUNZIONAMENTO

## “SLICER” - COLUMNS MODULARITY AND OPERATION DETAILS

### MODULARITÀ DELLE COLONNE - COLUMNS MODULARITY

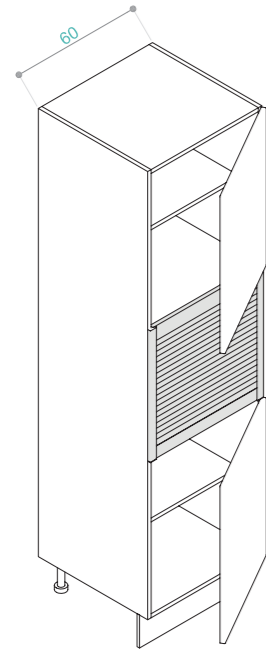

#### • NECK/LUX (push-pull)

##### ZOCCOLO H 13 - PLINTH H 13

- ANTA DX/SX DOOR RH/LH	H 145 H 217 H 228	G6056801/2 G606680A1/2 G607680A1/2
----------------------------	-------------------------	--

- ANTA + CASSETTI/CESTONI INTERNI DOOR + INTERNAL DRAWERS/DEEP DRAWERS	H 145 H 217 H 228	G6056821/2 G6066821/2 G6076821/2
---	-------------------------	--

##### ZOCCOLO H 6 - PLINTH H 6

- ANTA DX/SX DOOR RH/LH	H 150 H 222	GC055801/2 GC07580A1/2
----------------------------	----------------	---------------------------

- ANTA + CASSETTI/CESTONI INTERNI DOOR + INTERNAL DRAWERS/DEEP DRAWERS	H 150 H 222	GC055811/2 GC075811/2
---	----------------	--------------------------

N.B.: LA GOLA DEVE ESSERE OBBLIGATORIAMENTE TIPO “CP-DP-E”  
NOTE: FINGER RAIL MUST BE INEVITABLY TYPE “CP-DP-E”

#### • BRIDGE/HEAD

##### ZOCCOLO H 13 - PLINTH H 13

- ANTA DX/SX DOOR RH/LH	H 145 H 217 H 228	E6056801/2 E606680A1/2 E607680A1/2
----------------------------	-------------------------	--

- ANTA + CASSETTI/CESTONI DOOR + DRAWERS/DEEP DRAWERS	H 145 H 217 H 228	E6056810 E6056820 E6066811/2 E6066821/2 E6076811/2 E6076821/2
--	-------------------------	--

##### ZOCCOLO H 6 - PLINTH H 6

- ANTA DX/SX DOOR RH/LH	H 150 H 222	EC055801/2 EC07580A1/2
----------------------------	----------------	---------------------------

- ANTA + CASSETTI/CESTONI DOOR + DRAWERS/DEEP DRAWERS	H 150 H 222	EC055810 EC055820 EC075811/2 EC075821/2
--	----------------	--

### DETTAGLI FUNZIONAMENTO - OPERATION DETAILS



Finitura piano: Faggio listellare - Worktop finish: Blockboard beech



# “SLICER”- INGOMBRI E RIFERIMENTI LISTINO

## “SLICER”- TECHNICAL DIMENSIONS AND PRICE LIST

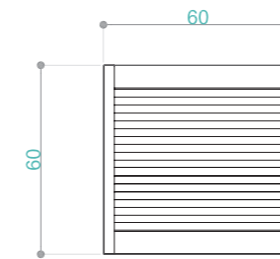

VISTA FRONTALE  
FRONT VIEW

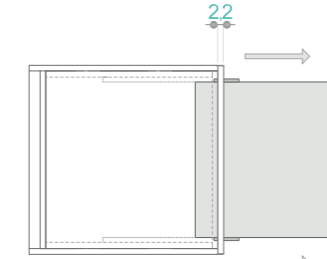

VISTA PIANTA  
TOP VIEW

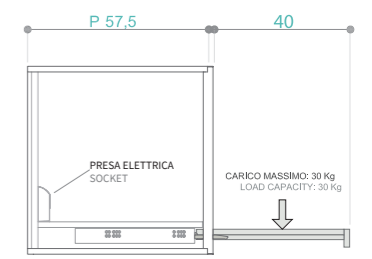

VISTA LATERALE  
SIDE VIEW

### DESCRIZIONE MODELLO MODEL DESCRIPTION

### VERSIONE VERSION

### DIMENSIONE COLONNE COLUMNS DIMENSION

#### PIANO ESTRAIBILE

Completo di meccanismo per lo scorrimento e presa elettrica (1 schuko e 2 usb)

Finiture: piano estraibile in melaminico disponibile nei colori come struttura o in faggio listellare.

Note: carico massimo supportato 30 kg (uniformemente distribuiti)

#### PULL-OUT WORKTOP

Complete with sliding mechanism and socket (1 schuko and 2 usb)

Finishes: melamine pull-out worktop available in the same colours as carcass or in blockboard beech.

Note: load capacity 30 kg (evenly distributed)

### FINITURE SERRANDINA - SHUTTER FINISHES

#### Doga alluminio microforato - Perforated aluminium slat

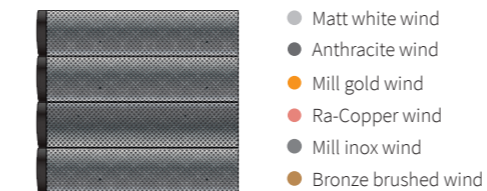

Telaio e doga con finiture alluminio in tinta.  
Frame and slat with aluminium finishes matching.

#### Doga laminata Fenix - Laminated Fenix slat finishes

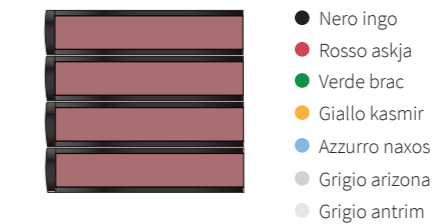

Telaio verniciato nero e doga nei colori disponibili.  
Black coated frame and slat in the available colours.

N.B.: LA COLONNA DEVE ESSERE ANCORATA OBBLIGATORIAMENTE A MURO TRAMITE ATTACCAGGIE IN DOTAZIONE. NON DISPONIBILE PER FUORI MISURA.  
NOTE: THE COLUMN MUST NECESSARILY BE ANCHORED TO THE WALL USING THE SUPPLIED HANGERS. CUSTOM SIZE NOT AVAILABLE.

# Slicer Box

PIANO ESTRAIBILE  
PULL-OUT WORKTOP

BASI - BASE UNITS ●

COLONNE - COLUMNS ●



# “SLICER BOX” - MODULARITÀ E DETTAGLI FUNZIONAMENTO

## “SLICER BOX” - MODULARITY AND OPERATION DETAILS

### RIFERIMENTI DIMENSIONALI - OVERALL DIMENSIONS

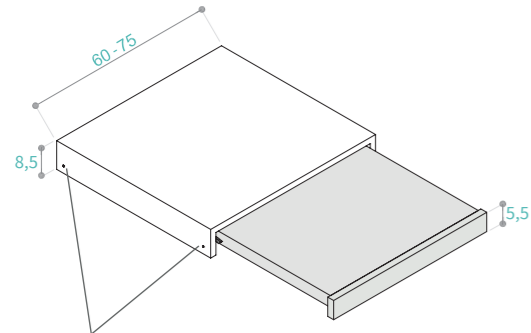

Fissaggio sul fianco del mobile tramite gli appositi fori già presenti  
Fixing on the side of the furniture using the holes already provided

PUÒ ESSERE INSERITO NELLE BASI E NELLE COLONNE.  
DISPONIBILE PER LE VERSIONI NECK/LUX/BRIDGE/HEAD.  
CAN BE INSERTED INTO BASE UNITS AND COLUMNS.  
AVAILABLE FOR NECK/LUX/BRIDGE/HEAD VERSIONS.

### FINITURE DISPONIBILI - AVAILABLE FINISHES

- COLORE COME STRUTTURA (uso piano d'appoggio)**  
 BLOCKBOARD BEECH (use worktop)
  - L 60 08705653
  - L 75 08705655
- FAGGIO LISTELLARE (uso tagliere)**  
 BLOCKBOARD BEECH (use cutting board)
  - L 60 08705663
  - L 75 08705665

### DETTAGLI FUNZIONAMENTO - OPERATION DETAILS



# “SLICER BOX”- INGOMBRI E RIFERIMENTI LISTINO

## “SLICER BOX”- TECHNICAL DIMENSIONS AND PRICE LIST

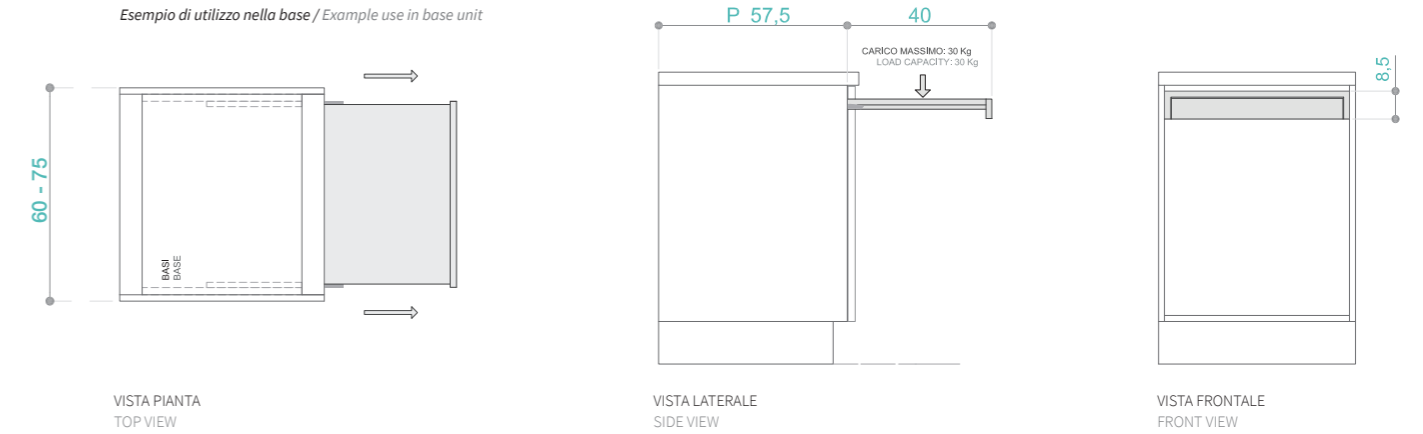

DESCRIZIONE MODELLO MODEL DESCRIPTION	VERSIONE VERSION	DIMENSIONE DIMENSION
<b>PIANO ESTRAIBILE</b> Completo di meccanismo per lo scorrimento e struttura in nobilitato  Finiture: piano estraibile in melaminico disponibile nei colori come struttura o in faggio listellare (uso tagliere).  Note: carico massimo supportato 30 kg (uniformemente distribuiti)	Gola Finger rail	60 - 75
	(Neck-Lux)	
<b>PULL-OUT WORKTOP</b> Complete with sliding mechanism and melamine-coated carcass  Finiture: melamine pull-out worktop available in the same colours as carcass or in blockboard beech (use cutting board).  Note: load capacity 30 kg (evenly distributed)	Maniglia Handle	60 - 75
	(Bridge-Head)	

N.B.: LA BASE O COLONNA DEVE ESSERE ANCORATA OBBLIGATORIAMENTE A MURO TRAMITE ATTACCAGGIE IN DOTAZIONE. NON DISPONIBILE PER FUORI MISURA.  
NOTE: THE BASE UNIT OR COLUMN MUST NECESSARILY BE ANCHORED TO THE WALL USING THE SUPPLIED HANGERS. CUSTOM SIZE NOT AVAILABLE.

# Slicer Box Dustbin

TAGLIERE ESTRAIBILE SU PATTUMIERA  
PULL-OUT CUTTING BOARD ON DUSTBIN

BASI - BASE UNITS ●



“SLICER BOX” CON PATTUMIERA - MODULARITÀ E DETTAGLI FUNZIONAMENTO  
 “SLICER BOX” WITH DUSTBIN - MODULARITY AND OPERATION DETAILS

RIFERIMENTI DIMENSIONALI - OVERALL DIMENSIONS

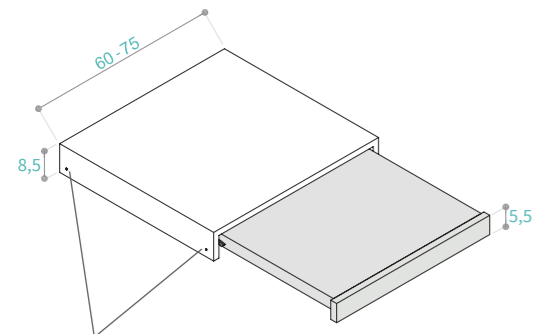

Fissato sui fianchi della base tramite gli appositi fori già presenti  
 Fixing on the sides of the base unit using the holes already provided

DETTAGLI FUNZIONAMENTO - OPERATION DETAILS



**TAGLIERE IN FAGGIO LISTELLARE SU BASE PATTUMIERA**  
 BLOCKBOARD BEECH CUTTING BOARD ON DUSTBIN BASE UNIT

**ZOCCOLO H 13 - PLINTH H 13**

- NECK/LUX	L 60 L 75	G421560T G421575T
- BRIDGE/HEAD	L 60 L 75	E421560T E421575T

**ZOCCOLO H 6 - PLINTH H 6**

- NECK/LUX	L 60 L 75	GB21560T GB21575T
- BRIDGE/HEAD	L 60 L 75	EB21560T EB21575T



“SLICER BOX” CON PATTUMIERA- INGOMBRI E RIFERIMENTI LISTINO  
 “SLICER BOX” WITH DUSTBIN- TECHNICAL DIMENSIONS AND PRICE LIST

Esempio di utilizzo nella base / Example use in base unit

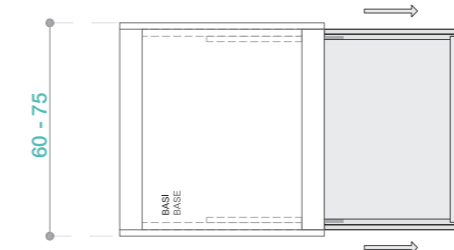

VISTA PIANTA  
TOP VIEW

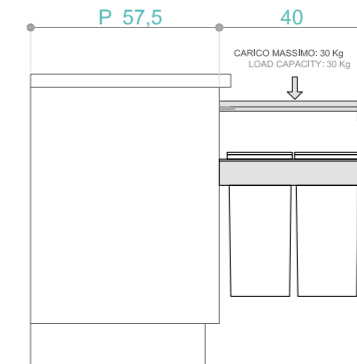

VISTA LATERALE  
SIDE VIEW

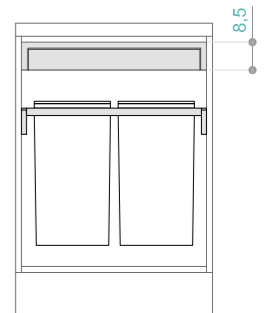

VISTA FRONTALE  
FRONT VIEW

DESCRIZIONE MODELLO MODEL DESCRIPTION	VERSIONE VERSION	DIMENSIONE DIMENSION
--	---------------------	-------------------------

**TAGLIERE ESTRAIBILE SU BASE PATTUMIERA**

Completo di meccanismo per lo scorrimento e struttura in nobilitato

Finiture: tagliere estraibile in faggio listellare.  
 Pattumiere colore orion grau.

Note: carico massimo supportato 30 kg (uniformemente distribuiti)

Gola  
Finger rail  
(Neck-Lux)

60 - 75

**PULL-OUT CUTTING BOARD ON DUSTBIN BASE UNIT**

Complete with sliding mechanism and melamine-coated carcass

Finishes: pull-out cutting board available in blockboard beech.  
 Dustbins in orion grau colour.

Note: load capacity 30 kg (evenly distributed)

Maniglia  
Handle  
(Bridge-Head)

60 - 75

N.B.: LA BASE DEVE ESSERE ANCORATA OBBLIGATORIAMENTE A MURO TRAMITE ATTACCAGLIE IN DOTAZIONE. NON DISPONIBILE PER FUORI MISURA.  
 NOTE: THE BASE UNIT MUST NECESSARILY BE ANCHORED TO THE WALL USING THE SUPPLIED HANGERS. CUSTOM SIZE NOT AVAILABLE.

# Extra

VANO ATTREZZATO CON SERRANDINA  
EQUIPPED COMPARTMENT WITH SHUTTER

COLONNE - COLUMNS ●



# “EXTRA” - MODULARITÀ DELLE COLONNE E DETTAGLI FUNZIONAMENTO

## “EXTRA” - COLUMNS MODULARITY AND OPERATION DETAILS

### MODULARITÀ DELLE COLONNE - COLUMNS MODULARITY

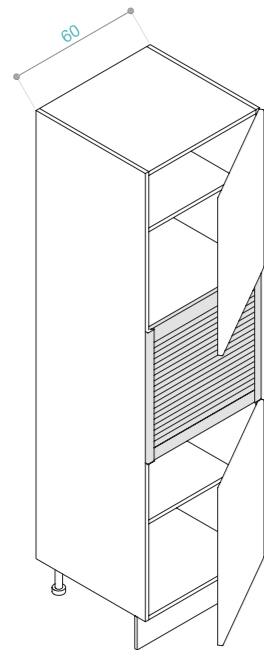

#### • NECK/LUX (push-pull)

##### ZOCCOLO H 13 - PLINTH H 13

- ANTA DX/SX DOOR RH/LH	H 145 H 217 H 228	G6056801/2 G606680A1/2 G607680A1/2
----------------------------	-------------------------	--

- ANTA + CASSETTI/CESTONI INTERNI DOOR + INTERNAL DRAWERS/DEEP DRAWERS	H 145 H 217 H 228	G6056821/2 G6066821/2 G6076821/2
---	-------------------------	--

##### ZOCCOLO H 6 - PLINTH H 6

- ANTA DX/SX DOOR RH/LH	H 150 H 222	GC055801/2 GC07580A1/2
----------------------------	----------------	---------------------------

- ANTA + CASSETTI/CESTONI INTERNI DOOR + INTERNAL DRAWERS/DEEP DRAWERS	H 150 H 222	GC055811/2 GC075811/2
---	----------------	--------------------------

N.B.: LA GOLA DEVE ESSERE OBBLIGATORIAMENTE TIPO “CP-DP-E”  
NOTE: FINGER RAIL MUST BE INEVITABLY TYPE “CP-DP-E”

#### • BRIDGE/HEAD

##### ZOCCOLO H 13 - PLINTH H 13

- ANTA DX/SX DOOR RH/LH	H 145 H 217 H 228	E6056801/2 E606680A1/2 E607680A1/2
----------------------------	-------------------------	--

- ANTA + CASSETTI/CESTONI DOOR + DRAWERS/DEEP DRAWERS	H 145 H 217 H 228	E6056810 E6056820 E6066811/2 E6066821/2 E6076811/2 E6076821/2
--	-------------------------	--

##### ZOCCOLO H 6 - PLINTH H 6

- ANTA DX/SX DOOR RH/LH	H 150 H 222	EC055801/2 EC07580A1/2
----------------------------	----------------	---------------------------

- ANTA + CASSETTI/CESTONI DOOR + DRAWERS/DEEP DRAWERS	H 150 H 222	EC055810 EC055820 EC075811/2 EC075821/2
--	----------------	--

### DETTAGLI FUNZIONAMENTO - OPERATION DETAILS



Colore piano: Bianco - Worktop colour: White



# “EXTRA”- INGOMBRI E RIFERIMENTI LISTINO

## “EXTRA”- TECHNICAL DIMENSIONS AND PRICE LIST

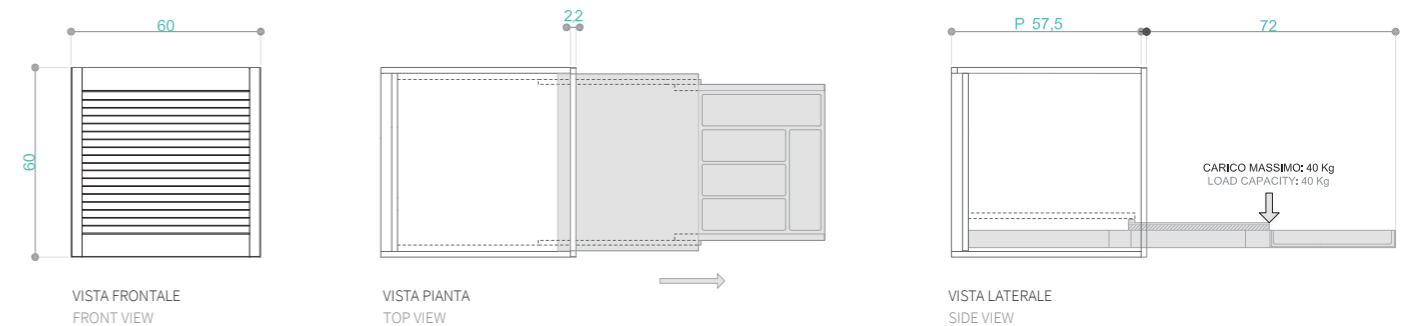

DESCRIZIONE MODELLO  
MODEL DESCRIPTION

VERSIONE  
VERSION

DIMENSIONE COLONNE  
COLUMNS DIMENSION

#### PIANO ESTRAIBILE CON CASSETTO

Completo di meccanismo per lo scorrimento

Gola

Finger rail

60

Finiture: piano in melaminico disponibile nei colori come struttura.  
Porta posate realizzate in faggio listellare fresato.

(Neck-Lux)

Note: carico massimo supportato 40 kg (uniformemente distribuiti)

Maniglia  
Handle

60

#### PULL-OUT WORKTOP WITH DRAWER

Complete with sliding mechanism

(Bridge-Head)

Finishes: melamine worktop available in the same colours as carcass.  
Cutlery tray is made by milled blockboard beech.

Note: load capacity 40 kg (evenly distributed)

#### ACCESSORI INCLUSI - INCLUDED ACCESSORIES

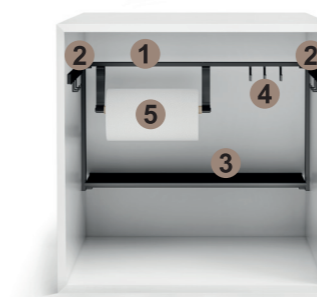

1) BARRA CENTRALE: completa di 2 montanti + 2 traversi  
CENTRAL BAR: including with 2 uprights + 2 crosspieces

2) BARRE LATERALE PORTA GANCI: 2 barre L 30 con 3 ganci  
HOOK HOLDER SIDE BARS: 2 bars W 30 with 3 hooks

3) MENSOLA: 58 x 15 x 0,3 cm (L x P x H)  
SHELF: 58 x 15 x 0,3 cm (W x D x H)

4) SET GANCI: set di 3 ganci  
HOOKS SET: set of 3 hooks

5) PORTA ROTOLO: 28,5 x 5 x 12 cm (L x P x H)  
ROLL HOLDER: 28,5 x 5 x 12 cm (W x D x H)

#### FINITURE SERRANDINA - SHUTTER FINISHES

Doga alluminio microforato - Perforated aluminium slat



- Matt white wind
- Anthracite wind
- Mill gold wind
- Ra-Copper wind
- Mill inox wind
- Bronze brushed wind

Telaio e doga con finiture alluminio in tinta.  
Frame and slat with aluminium finishes matching.

Doga laminata Fenix - Laminate Fenix slat finishes



- Nero ingo
- Rosso askja
- Verde brac
- Giallo kasmir
- Azzurro naxos
- Grigio arizona
- Grigio antrim

Telaio verniciato nero e doga nei colori disponibili.  
Black coated frame and slat in the available colours.

N.B.: LA COLONNA DEVE ESSERE ANCORATA OBBLIGATORIAMENTE A MURO TRAMITE ATTACCAGGIE IN DOTAZIONE. NON DISPONIBILE PER FUORI MISURA.  
NOTE: THE COLUMN MUST NECESSARILY BE ANCHORED TO THE WALL USING THE SUPPLIED HANGERS. CUSTOM SIZE NOT AVAILABLE.



# Roll

MOBILE IN APPOGGIO CON SERRANDINA  
FREE-STANDING FURNITURE WITH SHUTTER

PENSILI - WALL UNITS ●



# “ROLL” - MODULARITÀ DEI PENSILI E DETTAGLI FUNZIONAMENTO

## “ROLL” - WALL UNITS MODULARITY AND OPERATION DETAILS

### MODULARITÀ DEI PENSILI - WALL UNITS MODULARITY



TABELLA “H” MOBILE (cm)  
TABLE “H” FURNITURE (cm)

SP. TOP	H NECK/LUX	H BRIDGE/HEAD
1,2	127,8	130,8
2	127	130
3	126	129
4	125	128

### DETTAGLI FUNZIONAMENTO - OPERATION DETAILS

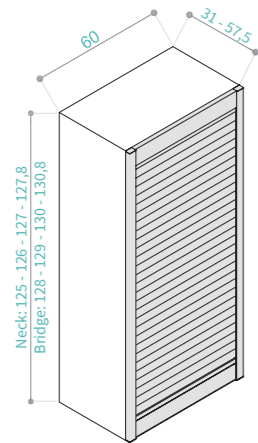

#### • NECK/LUX

##### MOBILE P 31- FURNITURE D 31

H 125	E299710N
H 126	E299712N
H 127	E299714N
H 127,8	E299716N

##### MOBILE P 57,5- FURNITURE D 57,5

H 125	E299740N
H 126	E299742N
H 127	E299744N
H 127,8	E299746N

#### • BRIDGE/HEAD

##### MOBILE P 31- FURNITURE D 31

H 128	E299720B
H 129	E299722B
H 130	E299724B
H 130,8	E299726B

##### MOBILE P 57,5- FURNITURE D 57,5

H 128	E299750B
H 129	E299752B
H 130	E299754B
H 130,8	E299756B

# “ROLL” - INGOMBRI E RIFERIMENTI LISTINO

## “ROLL” - TECHNICAL DIMENSIONS AND PRICE LIST

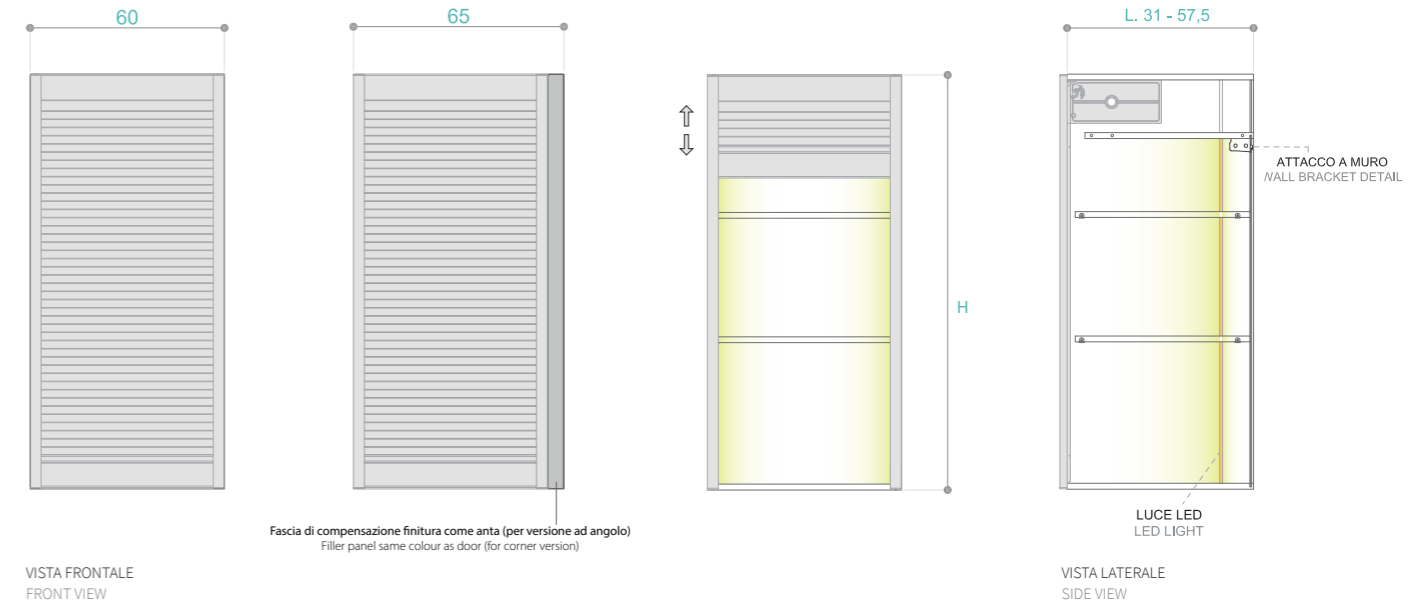

DESCRIZIONE MODELLO  
MODEL DESCRIPTION

VERSIONE  
VERSION

DIMENSIONE PENSILI  
WALL UNITS DIMENSION

#### MOBILE CON SERRANDINA

Completo di meccanismo per lo scorrimento

Gola  
Finger rail  
  
(Neck-Lux)

60

Finiture mobile: colori come struttura.

Kit luce led disponibile su un fianco o su entrambi i fianchi.

Note: per la “versione angolo” è obbligatorio inserire una fascia di compensazione da 5 cm

#### FURNITURE WITH SHUTTER

Complete with sliding mechanism

Maniglia  
Handle  
  
(Bridge-Head)

60

Furniture finishes: same colours as carcass.

Led light kit available on one or both sides.

Note: filler panel 5 cm is obligatory for “corner version”

#### FINITURE SERRANDINA - SHUTTER FINISHES

Doga alluminio microforato - Perforated aluminium slat

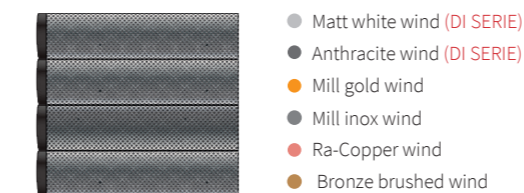

Telaio e doge con finiture alluminio in tinta.  
Frame and slat with aluminium finishes matching.

Doga laminata Fenix - Laminate Fenix slat finishes

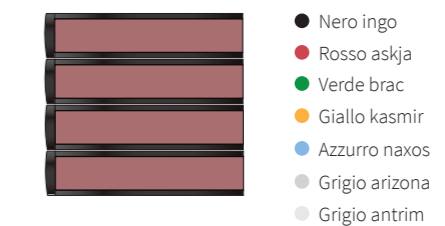

Telaio verniciato nero e doge nei colori disponibili.  
Black coated frame and slat in the available colours.

N.B.: IL PENSILE DEVE ESSERE ANCORATA OBBLIGATORIAMENTE A MURO TRAMITE ATTACCAGLIE IN DOTAZIONE. NON DISPONIBILE PER FUORI MISURA.  
NOTE: THE WALL UNIT MUST NECESSARILY BE ANCHORED TO THE WALL USING THE SUPPLIED HANGERS. CUSTOM SIZE NOT AVAILABLE.

# Flux Base

TAVOLO ESTRAIBILE CON GAMBE  
PULL-OUT TABLE WITH LEGS

BASI - BASE UNITS ●



# “FLUX” - MODULARITÀ DELLE BASI E DETTAGLI FUNZIONAMENTO

## “FLUX” - BASE UNITS MODULARITY AND OPERATION DETAILS

### MODULARITÀ DELLE BASI - BASE UNITS MODULARITY

#### NECK/LUX - FRONTALE SINGOLO - SINGLE FRONT PANEL

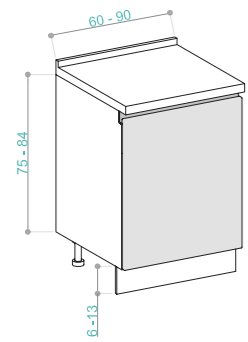

##### ZOCCOLO H 13 - PLINTH H 13

ANTA DOOR H 717  
L 60 G4222600  
L 90 G4222900

##### ZOCCOLO H 6 - PLINTH H 6

ANTA DOOR H 807  
L 60 GB222600  
L 90 GB222900

#### BRIDGE/HEAD - FRONTALE SINGOLO - SINGLE FRONT PANEL

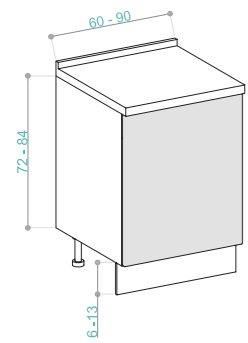

##### ZOCCOLO H 13 - PLINTH H 13

ANTA DOOR H 717  
L 60 E4222600  
L 90 E4222900

##### ZOCCOLO H 6 - PLINTH H 6

ANTA DOOR H 837  
L 60 EB222600  
L 90 EB222900

### DETTAGLI FUNZIONAMENTO - OPERATION DETAILS



Colore piano: Visone - Worktop colour: Mink



# “FLUX” - INGOMBRI E RIFERIMENTI LISTINO

## “FLUX” - TECHNICAL DIMENSIONS AND PRICE LIST

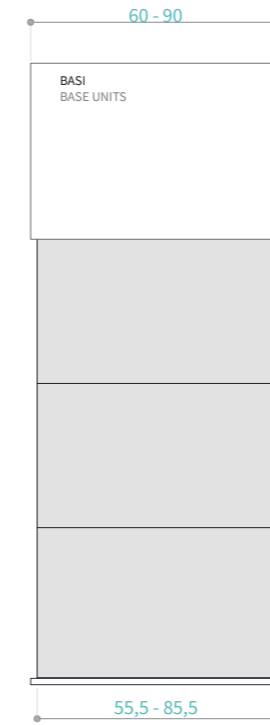

VISTA PIANTA  
TOP VIEW

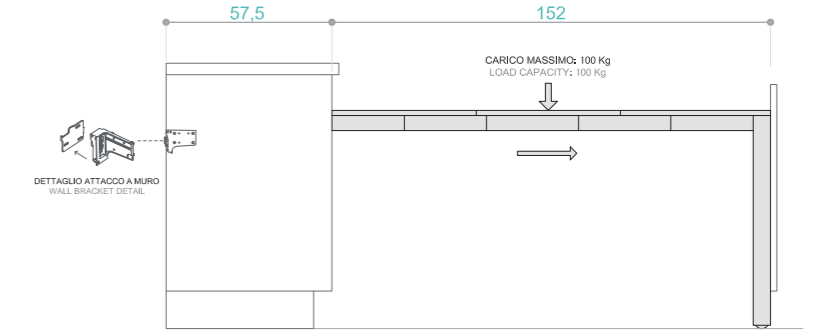

VISTA LATERALE  
SIDE VIEW

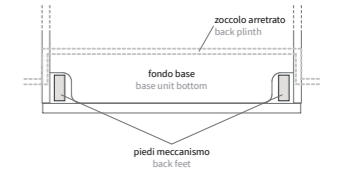
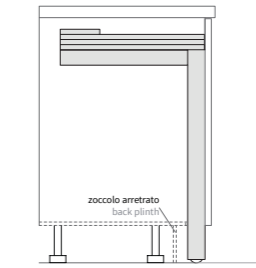

DETTAGLIO ZOCCOLO E FONDO BASE  
PLINTH AND BOTTOM BASE UNIT DETAIL

Lo zoccolo è montato in posizione più arretrata rispetto allo standard, mentre il fondo della base ha due scassi per lasciare spazio ai piedi del meccanismo in fase di chiusura.  
The plinth is mounted further back than standard, while the bottom of the base unit is made with two slots to leave space for the feet of the closing mechanism.

DESCRIZIONE MODELLO  
MODEL DESCRIPTION

VERSIONE  
VERSION

DIMENSIONE BASI  
BASE UNITS DIMENSION

**TAVOLO ESTRAIBILE CON GAMBE**  
Completo di meccanismo per lo scorrimento

Gola  
Finger rail  
  
(Neck-Lux)

60 - 90

Finiture piano: melaminico disponibile nei colori come struttura  
Finitura guide: inox bronzino  
Finitura gambe: nero opaco verniciato

Note: carico massimo supportato 100 kg (uniformemente distribuiti)

**PULL-OUT TABLE WITH LEGS**  
With sliding mechanism

Maniglia  
Handle  
  
(Bridge-Head)

60 - 90

Worktop finishes: melamine available in the same colours as carcass  
Guides finish: bronzino stainless steel  
Legs finish: painted matt black

Note: load capacity 100 kg (evenly distributed)

N.B.: LA BASE DEVE ESSERE ANCORATA OBBLIGATORIAMENTE A MURO TRAMITE ATTACCAGGIE IN DOTAZIONE. NON DISPONIBILE PER FUORI MISURA.  
NOTE: THE BASE UNIT MUST NECESSARILY BE ANCHORED TO THE WALL USING THE SUPPLIED HANGERS. CUSTOM SIZE NOT AVAILABLE.

# Voilà

PIANO ESTRAIBILE CON GAMBE  
PULL-OUT WORKTOP WITH LEGS

ISOLA/PENISOLA - ISLAND/PENINSULA ●



# “VOILA” - MODULARITÀ DELLE BASI E DETTAGLI FUNZIONAMENTO

## “VOILA” - BASE UNITS MODULARITY AND OPERATION DETAILS

### CARATTERISTICHE GUIDE - GUIDES FEATURES

#### FINITURA GUIDE GUIDES FINISH

- Inox bronzino
- Bronzino stainless steel

#### FINITURA GAMBE TABLE LEGS FINISH

- Grigio piombo opaco
- Matt lead grey

#### CARICO MASSIMO LOAD CAPACITY

- 100 kg uniformemente distribuiti
- 100 kg evenly distributed

#### TIPOLOGIA DI SCORRIMENTO SLIDES TYPE

- Alluminio/Alluminio
- Aluminium/Aluminium

### DETTAGLI FUNZIONAMENTO - OPERATION DETAILS



Colore piano: Fenix beige arizona - Worktop colour: Fenix arizona beige



# “VOILA” - INGOMBRI E RIFERIMENTI LISTINO

## “VOILA” - TECHNICAL DIMENSIONS AND PRICE LIST

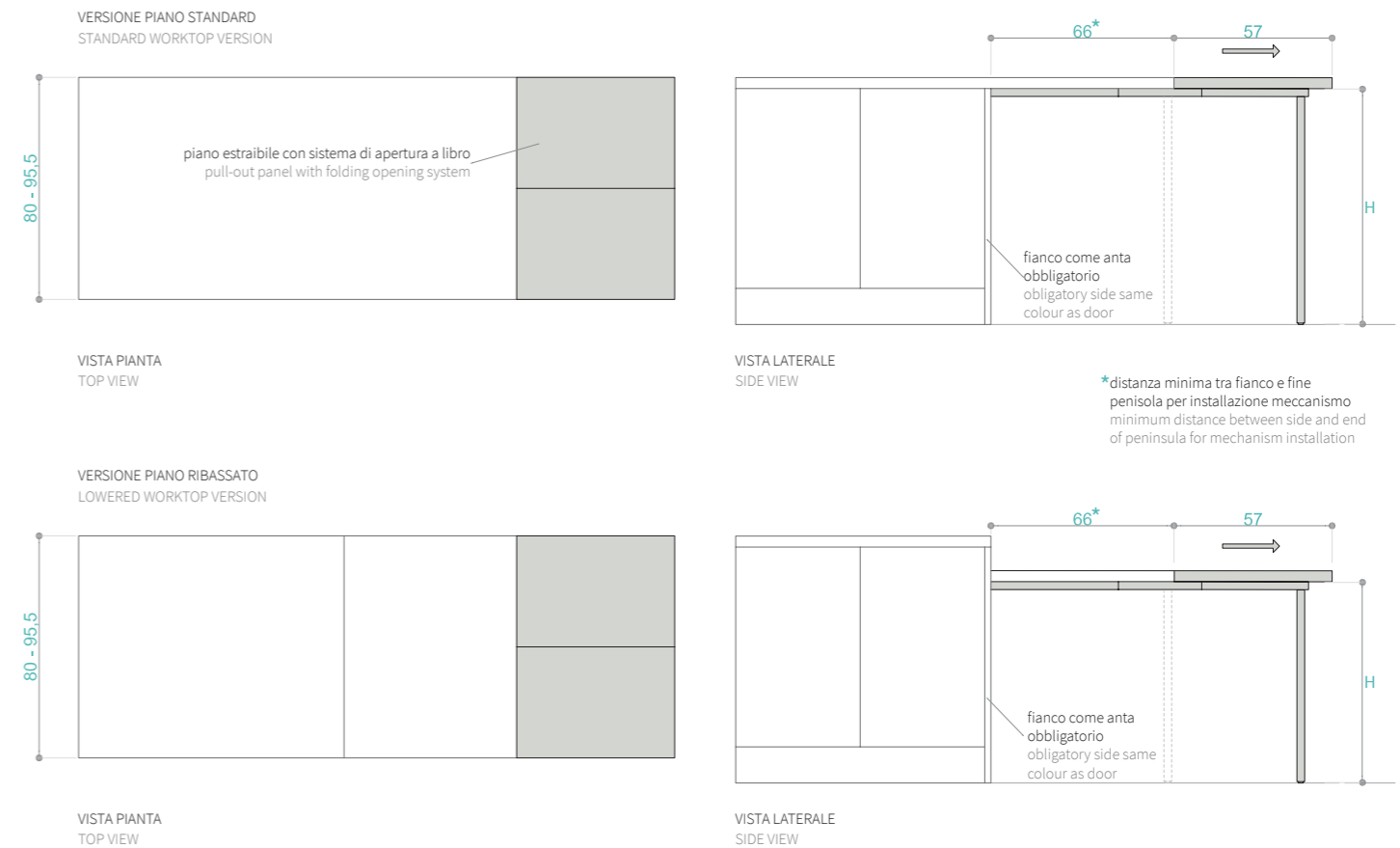

\*distanza minima tra fianco e fine penisola per installazione meccanismo  
minimum distance between side and end of peninsula for mechanism installation

Disponibile per modullistica Neck/Lux/Bridge/Head piedi H 6 e H 13.  
Available for Neck/Lux/Bridge/Head modules with plinth H 6 and H 13.

#### DESCRIZIONE MODELLO MODEL DESCRIPTION

#### FINITURA ESTERNA EXTERNAL FINISH

#### DIMENSIONE BASI BASE UNITS DIMENSION

#### CODICE CODE No.

#### PIANO ESTRAIBILE CON GAMBE

Completo di meccanismo per lo scorrimento

Finiture: piano estraibile disponibile in laminato ABS1, Fenix e Unicolor H 2-4  
Carico massimo supportato 100 kg (uniformemente distribuiti)

#### PULL-OUT WORKTOP WITH LEGS

Complete with sliding mechanism

Finishes: pull-out worktop available in laminate ABS1, Fenix and Unicolor H 2-4  
Load capacity 100 kg (evenly distributed)

	Per Top H 2	
ABS1	80	TABS24057
Fenix	80	TFEN24057
Unicolor	80	TUNI24057
ABS1	95,5	TABS24357
Fenix	95,5	TFEN24357
Unicolor	95,5	TUNI24357
	Per Top H 4	
ABS1	80	TABS44057
Fenix	80	TFEN44057
Unicolor	80	TUNI44057
ABS1	95,5	TABS44357
Fenix	95,5	TFEN44357
Unicolor	95,5	TUNI44357

N.B.: LA BASE DEVE ESSERE ANCORATA OBBLIGATORIAMENTE A MURO TRAMITE ATTACCAGGIE IN DOTAZIONE. NON DISPONIBILE PER FUORI MISURA.  
NOTE: THE BASE UNIT MUST NECESSARILY BE ANCHORED TO THE WALL USING THE SUPPLIED HANGERS. CUSTOM SIZE NOT AVAILABLE.

# Dais

PEDANA ESTRAIBILE CON CASSETTO  
PULL-OUT PLATFORM WITH DRAWER

BASI - BASE UNITS ●



# “DAIS” - MODULARITÀ DELLE BASI E DETTAGLI FUNZIONAMENTO

## “DAIS” - BASE UNITS MODULARITY AND OPERATION DETAILS

### MODULARITÀ DELLE BASI - BASE UNITS MODULARITY

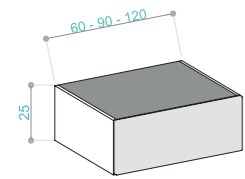

#### BASE H 25 - BASE UNIT H 25

CASSETTO H 247 (TIP-ON)  
DRAWER H 247 (TIP-ON)

L 60 EBL14600  
L 90 EBL14900  
L 120 EBL15200

In base alla composizione, inserire la base sospesa della modularistica corretta.  
Based on the composition, insert the hanging base unit of the right modularity.

### DETTAGLI FUNZIONAMENTO - OPERATION DETAILS



Colore struttura: Orion grau - Mechanism colour: Orion grau

### MODULARITÀ PER ABBINAMENTO BASI MODULARITY FOR BASE UNIT COMBINATION

#### • NECK/LUX - FRONTALE SINGOLO - SINGLE FRONT PANEL

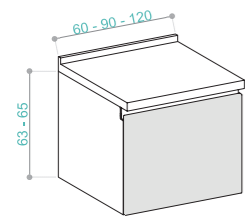

#### BASE H 63 - BASE UNIT H 63

ANTA H 597  
per modularistica Neck/Lux H 75  
DOOR H 597  
for modularity Neck/Lux H 75

#### BASE H 65 - BASE H 65

ANTA H 617  
per modularistica Neck/Lux H 84  
DOOR H 617  
for modularity Neck/Lux H 84

#### • BRIDGE/HEAD - FRONTALE SINGOLO - SINGLE FRONT PANEL

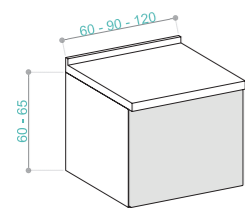

#### BASE H 60 - BASE UNIT H 60

ANTA H 597  
per modularistica Bridge/Head H 72  
DOOR H 597  
for modularity Bridge/Head H 72

#### BASE H 65 - BASE H 65

ANTA H 617  
per modularistica Bridge/Head H 84  
DOOR H 617  
for modularity Bridge/Head H 84



# “DAIS” - INGOMBRI E RIFERIMENTI VERSIONI

## “DAIS” - TECHNICAL DIMENSIONS AND VERSIONS

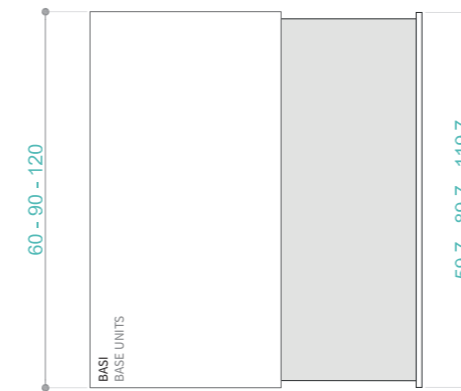

VISTA PIANTA  
TOP VIEW

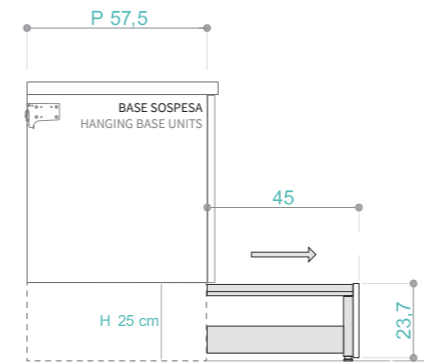

VISTA LATERALE  
SIDE VIEW

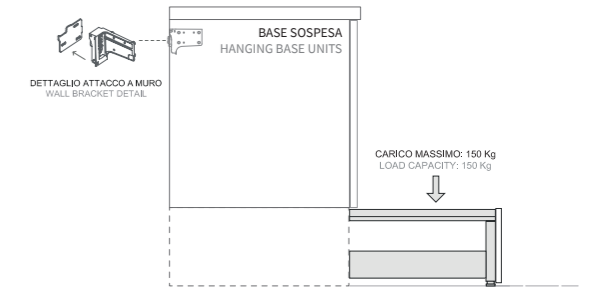

### DESCRIZIONE MODELLO MODEL DESCRIPTION

### VERSIONE VERSION

### DIMENSIONE BASI BASE UNITS DIMENSION

#### PEDANA ESTRAIBILE CON CASSETTO

Completo di meccanismo per lo scorrimento, apertura tip-on

(Neck-Lux)

60 - 90 - 120

Finiture: pedana con finitura antiscivolo

Note: carico massimo supportato 150 kg (uniformemente distribuiti)

#### PULL-OUT PLATFORM WITH DRAWER

With sliding mechanism, tip-on opening

(Bridge-Head)

60 - 90 - 120

Finishes: platform with non-slip finish

Note: load capacity 150 kg (evenly distributed)

N.B.: LA BASE NON È DISPONIBILE PER FUORI MISURA.

NOTE: THE BASE UNIT NOT AVAILABLE FOR CUSTOM SIZE.



# Bow

ASSE DA STIRO ESTRAIBILE  
PULL-OUT IRONING BOARD

BASI - BASE UNITS ●

ISOLA/PENISOLA - ISLAND/PENINSULA ●



“BOW” - MODULARITÀ DELLE BASI E DETTAGLI FUNZIONAMENTO  
 “BOW” - BASE UNITS MODULARITY AND OPERATION DETAILS

MODULARITÀ DELLE BASI - BASE UNITS MODULARITY

• **NECK/LUX - FRONTALE SINGOLO - SINGLE FRONT PANEL**

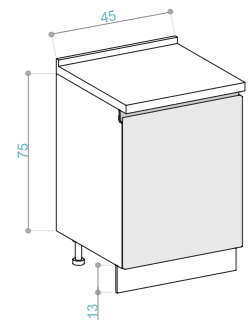

**ZOCCOLO H 13 - PLINTH H 13**  
 ANTA DOOR H 717  
 L 45 G4220451/2

**ZOCCOLO H 6 - PLINTH H 6**  
 NON DISPONIBILE  
 UNAVAILABLE

• **BRIDGE/HEAD - FRONTALE SINGOLO - SINGLE FRONT PANEL**

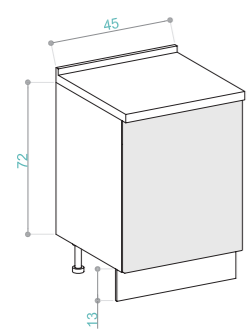

**ZOCCOLO H 13 - PLINTH H 13**  
 ANTA DOOR H 717  
 L 45 E4220451/2

**ZOCCOLO H 6 - PLINTH H 6**  
 NON DISPONIBILE  
 UNAVAILABLE

DETTAGLI FUNZIONAMENTO - OPERATION DETAILS



Finiture piano: Multistrato di betulla - Worktop finishes: Birch plywood



“BOW” - INGOMBRI E RIFERIMENTI LISTINO  
 “BOW” - TECHNICAL DIMENSIONS AND PRICE LIST

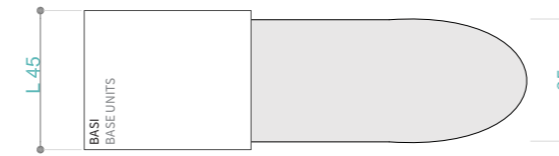

VISTA PIANTA  
 TOP VIEW

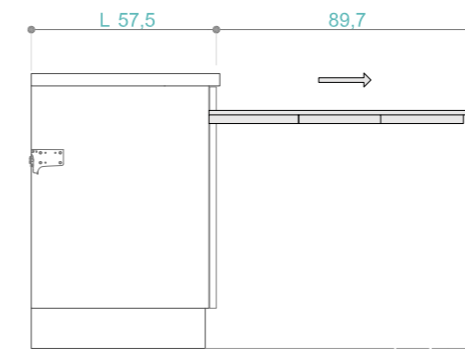

VISTA LATERALE  
 SIDE VIEW

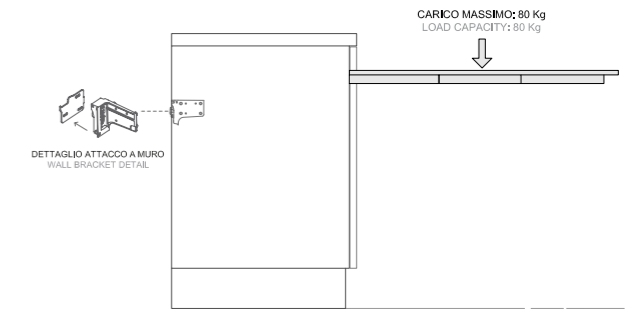

DESCRIZIONE MODELLO  
 MODEL DESCRIPTION

VERSIONE  
 VERSION

DIMENSIONE BASI  
 BASE UNITS DIMENSION

**ASSE DA STIRO ESTRAIBILE**

Completo di meccanismo per lo scorrimento

Gola  
 Finger rail  
 (Neck-Lux)

45

Finiture: multistrato di betulla fenolico. Piano rivestito con tessuto grigio  
 Note: carico massimo supportato 80 kg (uniformemente distribuiti)

**PULL-OUT IRONING BOARD**

Complete with sliding mechanism

Maniglia  
 Handle  
 (Bridge-Head)

45

Finishes: phenolic birch plywood. Worktop covered with gray cloth  
 Note: load capacity 80 kg (evenly distributed)

N.B.: LA BASE DEVE ESSERE ANCORATA OBBLIGATORIAMENTE A MURO TRAMITE ATTACCAGGIE IN DOTAZIONE. NON DISPONIBILE PER FUORI MISURA.  
 NOTE: THE BASE UNIT MUST NECESSARILY BE ANCHORED TO THE WALL USING THE SUPPLIED HANGERS. CUSTOM SIZE NOT AVAILABLE.

# Open

MOBILE ATTREZZATO CON PIANO A VASISTAS  
EQUIPPED FURNITURE WITH FLAP DOOR

LIVING ●



“OPEN” - MODULARITÀ DELLE BASI E DETTAGLI FUNZIONAMENTO  
 “OPEN” - BASE UNITS MODULARITY AND OPERATION DETAILS

MODULARITÀ DELLE BASI - BASE UNITS MODULARITY

• BRIDGE/HEAD - FRONTALE SINGOLO - SINGLE FRONT PANEL

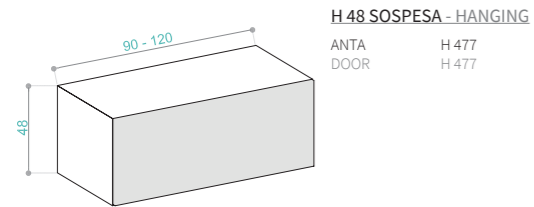

Melaminico - Melamine  
 L 90 EBL38190M  
 L 120 EBL38200M

Laccato opaco - Matt lacquered  
 L 90 EBL38190L  
 L 120 EBL38200L

Impiallacciato - Veneered  
 L 90 EBL38190I  
 L 120 EBL38200I

DETTAGLI FUNZIONAMENTO - OPERATION DETAILS



Finitura mobile: Laccato opaco Nero seppia - Furniture finish: Matt lacquered Cuttlefish ink

MODELLI DISPONIBILI - AVAILABLE MODELS

Melaminico - Melamine  
 - FA: Tablet  
 - FB: Immagina Plus  
 - FC: Unica

Laccato opaco - Matt lacquered  
 - FA: Immagina Plus UV, Tablet UV  
 - FB: Clover, Luna, Oltre, Flavour Liscia

Impiallacciato - Veneered  
 - FA: Clover "A", Luna "A"  
 - FB: Luna "B"  
 - FC: Clover "B", Oltre



“OPEN” - INGOMBRI E RIFERIMENTI LISTINO  
 “OPEN” - TECHNICAL DIMENSIONS AND PRICE LIST

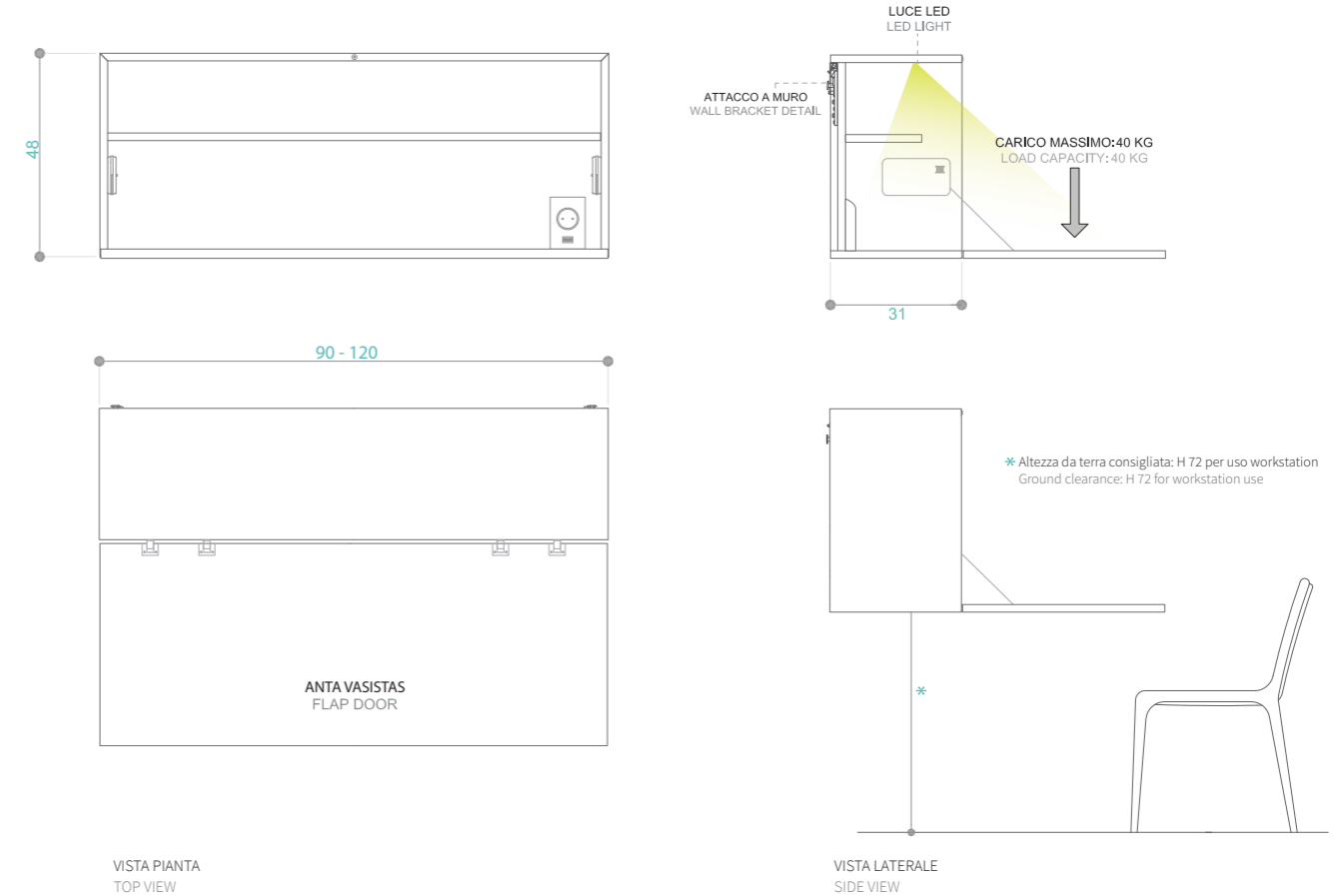

DESCRIZIONE MODELLO  
 MODEL DESCRIPTION

DIMENSIONE MOBILE  
 FURNITURE DIMENSION

MOBILE ATTREZZATO CON PIANO A VASISTAS

90 - 120

Completo di luce e presa elettrica

Finiture mobile: melaminico, laccato opaco, laccato opaco UV e impiallacciato.  
 Apertura anta push-pull.  
 Kit luce led con accensione a sfioramento.  
 Multipresa su mobile dotata di: 1 presa schuko, 1 presa usb-A, 1 presa usb-C

Note: carico massimo supportato 40 kg (uniformemente distribuiti)

EQUIPPED FURNITURE WITH FLAP DOOR

Complete with light and socket

Furniture finish: melamine, matt lacquered, matt lacquered UV and veneered.  
 Door with push-pull opening.  
 Kit led light with touch switch on.  
 Multiple socket including: 1 sockets schuko, 1 usb-A, 1 usb-C

Note: load capacity 40 kg (evenly distributed)

N.B.: LA BASE DEVE ESSERE ANCORATA OBBLIGATORIAMENTE A MURO TRAMITE ATTACCAGGIE IN DOTAZIONE. NON DISPONIBILE PER FUORI MISURA.  
 NOTE: THE BASE UNIT MUST NECESSARILY BE ANCHORED TO THE WALL USING THE SUPPLIED HANGERS. CUSTOM SIZE NOT AVAILABLE.

# Box Work

PARETE ATTREZZATA CON PIANO ESTRAIBILE  
EQUIPPED WALL WITH PULL-OUT WORKTOP

COLONNE - COLUMNS ●



“BOX WORK” - MODULARITÀ E DETTAGLI FUNZIONAMENTO  
 “BOX WORK” - MODULARITY AND OPERATION DETAILS

RIFERIMENTI DIMENSIONALI - OVERALL DIMENSIONS

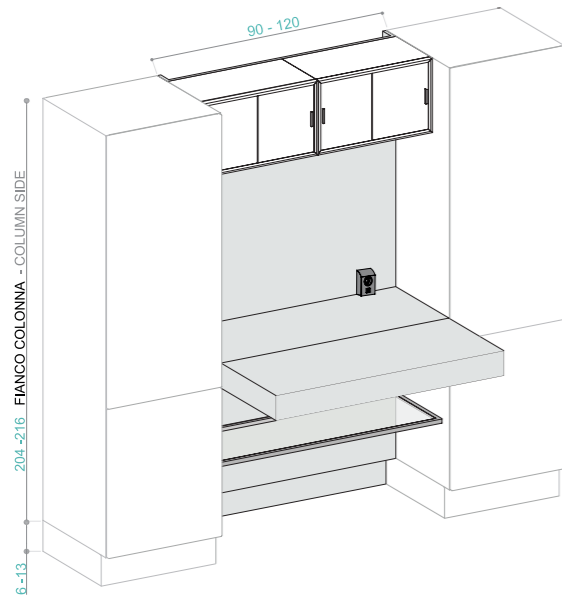

ZOCCOLO H 13 - PLINTH H 13

H 217 L 90 EBL38300B  
 H 217 L 120 EBL38305B

ZOCCOLO H 6 - PLINTH H 6

H 222 L 90 EBL38310B  
 H 222 L 120 EBL38315B

FINITURE EFFETTO MARMO - MARBLE EFFECT FINISHES



kaspio oro finitura flash  
 (opz.6089)  
 gold kaspio with flash finish

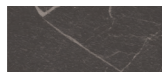

alabastro finitura mn  
 (opz.6014)  
 alabaster with mn finish



calacatta finitura mn  
 (opz.6019)  
 calacatta with mn finish

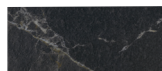

dark finitura mn  
 (opz.6133)  
 dark with mn finish

FINITURE EFFETTO LEGNO - WOOD EFFECT FINISHES



bramble finitura alevè  
 (opz.4611)  
 bramble with alevè finish



noce sinfonia  
 (opz.4625)  
 symphony walnut



rovere grigio  
 (opz.3264)  
 grey oak

DETTAGLI FUNZIONAMENTO - OPERATION DETAILS



“BOX WORK” - INGOMBRI E RIFERIMENTI LISTINO  
 “BOX WORK” - TECHNICAL DIMENSIONS AND PRICE LIST

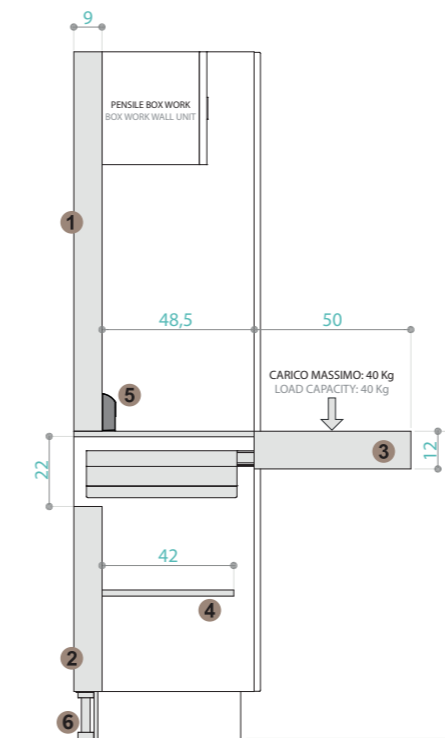

VISTA LATERALE  
 SIDE VIEW

- |   |   |
|---|---|
| 1) SCHIENALE SUPERIORE<br>UPPER BACK PANEL                          | 4) RIPIANO VETRO CON TELAIO ALLUMINIO<br>GLASS SHELF WITH ALUMINIUM FRAME |
| 2) SCHIENALE INFERIORE<br>LOWER BACK PANEL                          | 5) PRESA ELETTRICA: 1 schuko e 2 usb<br>SOCKET: 1 schuko and 2 usb        |
| 3) PIANO FISSO + PIANO ESTRAIBILE<br>FIXED SHELF + PULL-OUT WORKTOP | 6) ZOCCOLO<br>PLINTH  |

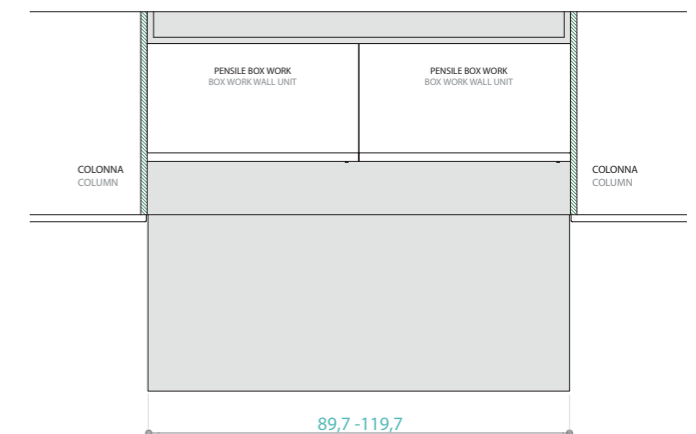

VISTA PIANTA  
 TOP VIEW

DESCRIZIONE MODELLO  
 MODEL DESCRIPTION

DIMENSIONE  
 DIMENSION

PARETE ATTREZZATA CON PIANO ESTRAIBILE

Completo di meccanismo per lo scorrimento e presa elettrica (1 schuko e 2 usb)

90 - 120

Schienali: laminato finiture effetto marmo ed effetto legno  
 Piano estraibile: laminato finiture effetto marmo ed effetto legno  
 Ripiano inferiore: vetro con telaio alluminio

Note: carico massimo supportato 40 kg (uniformemente distribuiti)

PULL-OUT TABLE WITH LEGS FOR NOOK COLUMNS

With sliding mechanism

Back panels: melamine-coated finishes marble effect or wood effect  
 Pull-out worktop: melamine-coated finishes marble effect or wood effect  
 Lower shelf: glass with aluminium frame

Note: load capacity 40 kg (evenly distributed)

N.B.: LA COLONNA DEVE ESSERE ANCORATA OBBLIGATORIAMENTE A MURO TRAMITE ATTACCAGLIE IN DOTAZIONE. NON DISPONIBILE PER FUORI MISURA.  
 NOTE: THE COLUMN MUST NECESSARILY BE ANCHORED TO THE WALL USING THE SUPPLIED HANGERS. CUSTOM SIZE NOT AVAILABLE.

“PENSILE BOX WORK” - MODULARITÀ E DETTAGLI FUNZIONAMENTO  
 “WALL UNIT BOX WORK” - MODULARITY AND OPERATION DETAILS

RIFERIMENTI DIMENSIONALI - OVERALL DIMENSIONS

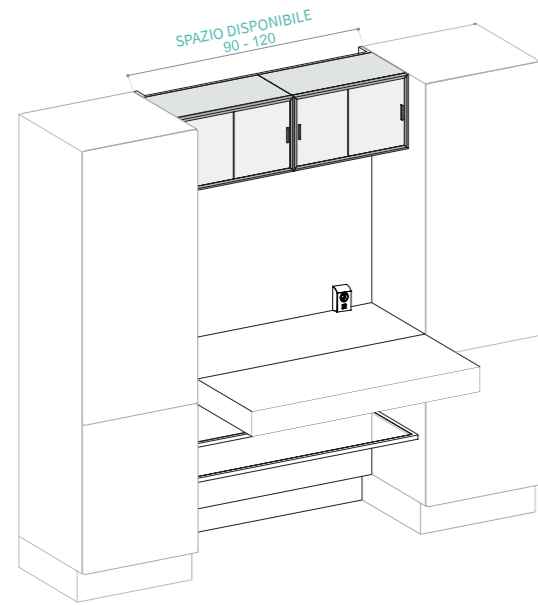

**SPAZIO DISPONIBILE**  
 Per L 90 cm inserire 1 pensile L 90  
 Per L 120 cm inserire 2 pensili L 60

**AVAILABLE SPACE**  
 For W 90 cm insert 1 wall unit W 90  
 For W 120 cm insert 2 wall units W 60

DETTAGLI FUNZIONAMENTO - OPERATION DETAILS



ANTA VETRO TELAIO ALLUMINIO - GLASS DOOR WITH ALUMINIUM FRAME

FINITURE TELAIO ALLUMINIO - ALUMINIUM FRAME FINISHES

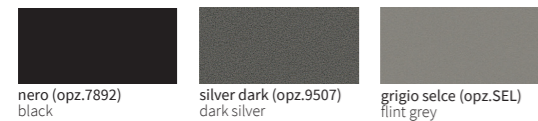

FINITURE VETRO - GLASS FINISHES



“PENSILE BOX WORK” - INGOMBRI E RIFERIMENTI LISTINO  
 “WALL UNIT BOX WORK” - TECHNICAL DIMENSIONS AND PRICE LIST

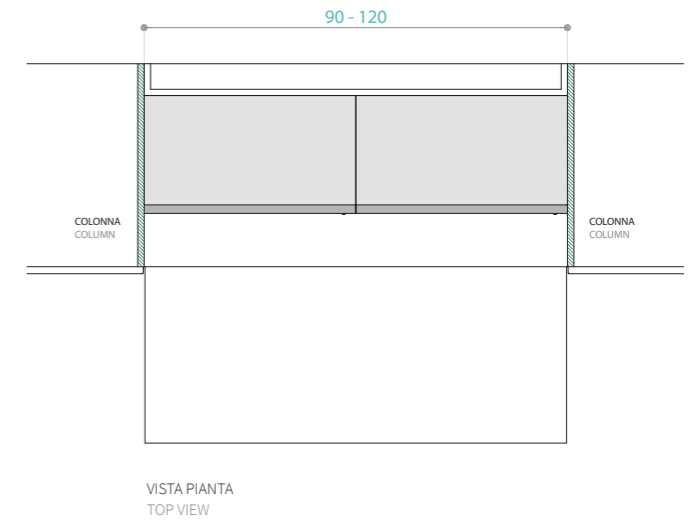
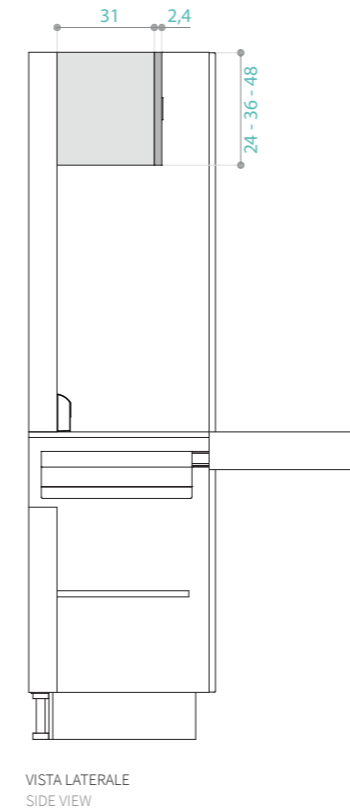

COLORE COME STRUTTURA		MELAMINICO		MATHERA	
H 24 L 60	EPF57160B	H 24 L 60	EPF54160B	H 24 L 60	EPF54160B
H 24 L 90	EPF57190B	H 24 L 90	EPF54190B	H 24 L 90	EPF54190B
H 36 L 60	EPF57260B	H 36 L 60	EPF54260B	H 36 L 60	EPF54260B
H 36 L 90	EPF57290B	H 36 L 90	EPF54290B	H 36 L 90	EPF54290B
H 48 L 60	EPF57360B	H 48 L 60	EPF54360B	H 48 L 60	EPF54360B
H 48 L 90	EPF57390B	H 48 L 90	EPF54390B	H 48 L 90	EPF54390B

LACCATO OPACO		IMPIALLACCIATO	
H 24 L 60	EPF55160B	H 24 L 60	EPF58160B
H 24 L 90	EPF55190B	H 24 L 90	EPF58190B
H 36 L 60	EPF55260B	H 36 L 60	EPF58260B
H 36 L 90	EPF55290B	H 36 L 90	EPF58290B
H 48 L 60	EPF55360B	H 48 L 60	EPF58360B
H 48 L 90	EPF55390B	H 48 L 90	EPF58390B

DESCRIZIONE MODELLO  
 MODEL DESCRIPTION

DIMENSIONE  
 DIMENSION

PENSILE FOLDING ANTA VETRO SCORREVOLE

60 - 90

Completo di attaccaglie a scomparsa

Finiture pensile: colore come struttura, melaminico, laccato e impiallacciato  
 Anta scorrevole: vetro con telaio alluminio

Note: disponibile kit luce led (vedi listino "Luci")

FOLDING WALL UNIT WITH SLIDING GLASS DOOR

With concealed hangers

Wall unit finishes: same colour as carcass, melamine, lacquered and veneered  
 Sliding door: glass with aluminium frame

Note: available led light kit (see "Light" pricelist)

N.B.: IL PENSILE DEVE ESSERE ANCORATO OBBLIGATORIAMENTE TRAMITE ATTACCAGLIE IN DOTAZIONE. NON DISPONIBILE PER FUORI MISURA.  
 NOTE: THE WALL UNIT MUST NECESSARILY BE ANCHORED USING THE SUPPLIED HANGERS. CUSTOM SIZE NOT AVAILABLE.

# Sistemi scorrevoli

## Sliding systems



# Glide

PIANO SCORREVOLE SU TOP  
SLIDING TABLE ON WORKTOP

ISOLA/PENISOLA - ISLAND/PENINSULA ●



# “GLIDE” - CARATTERISTICHE TECNICHE DEL MECCANISMO

## “GLIDE” - TECHNICAL MECHANISM SPECIFICATION

### CARATTERISTICHE GUIDE - GUIDES FEATURES

#### FINITURA GUIDE GUIDES FINISH

- Anodizzato naturale - Grigio satinato
- Anodized aluminium - Satin gray

#### CARICO MASSIMO LOAD CAPACITY

- 80 kg equamente distribuiti
- 80 kg evenly distributed

#### TIPOLOGIA DI SCORRIMENTO SLIDES TYPE

- Cuscinetti a sfera
- Ball-bearing slide system

### DETTAGLI FUNZIONAMENTO - OPERATION DETAILS



Colore piano scorrevole : Alabastro - Sliding worktop colour: Alabastro  
Versione penisola: Glide SX POSTERIORE - Version of peninsula: Glide LH REAR



# “GLIDE” - INGOMBRI E RIFERIMENTI LISTINO

## “GLIDE” - TECHNICAL DIMENSIONS AND PRICE LIST

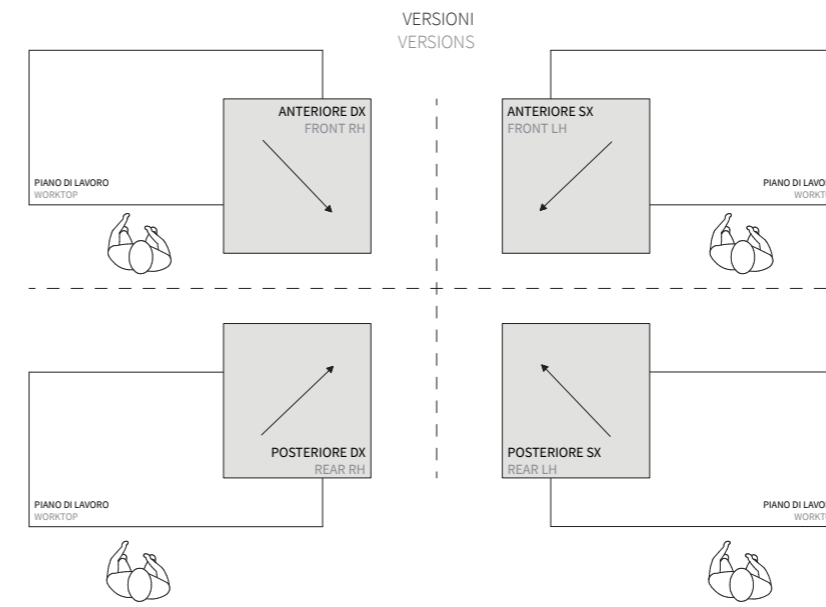
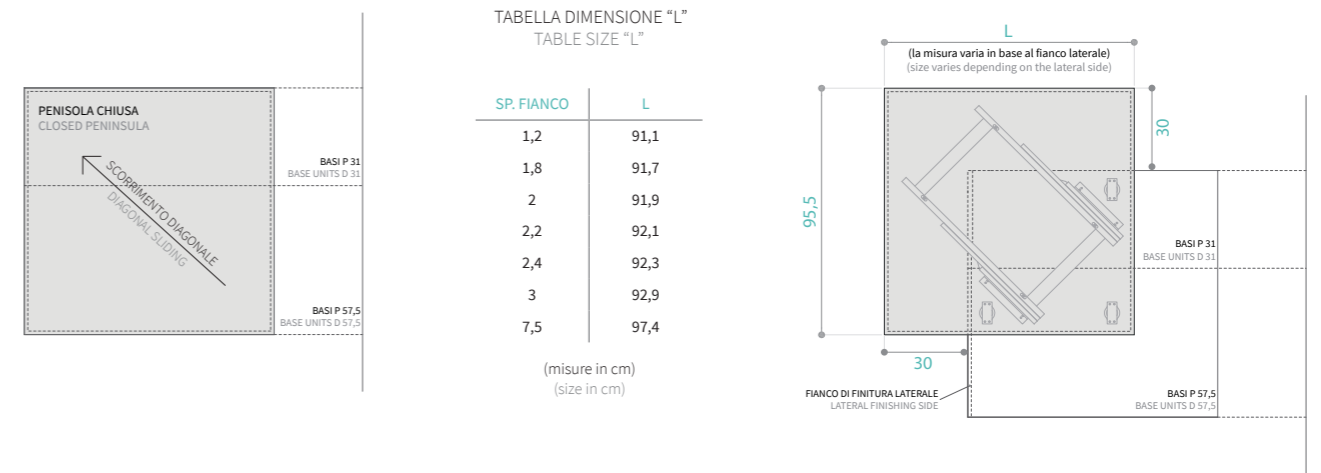

- ATTENZIONE:**
- LO SCORRIMENTO DELLA PENISOLA È DIAGONALE. È possibile installare le guide solamente in un'unica direzione: **destra o sinistra**
  - IN TUTTE LE SOLUZIONI INSERIRE SEMPRE IL FIANCO DI FINITURA LATERALE
  - PER LA VERSIONE AD ISOLA FISSARE SEMPRE LE BASI TRA LORO
  - È OBBLIGATORIO INSERIRE UNA COMPOSIZIONE DI BASI P 57,5+31 NELLA PARTE SOTTOSTANTE LA PENISOLA

- ATTENTIONS:**
- THE PENINSULA SLIDING DIRECTION IS DIAGONAL. It is possible to install the guides in only one direction: **right or left side**
  - INSERT ALWAYS LATERAL FINISHING SIDE IN ALL SOLUTIONS
  - IN THE ISLAND SOLUTION, FIX ALWAYS THE BASE UNITS AMONG THEMSELVES
  - BELOW THE PENINSULA IT IS REQUIRED TO INSERT A COMPOSITION OF BASE UNITS D 57,5+31

DESCRIZIONE MODELLO MODEL DESCRIPTION	FINITURA ESTERNA EXTERNAL FINISH	CODICE CODE No.
<b>PENISOLA GLIDE H 7,5 P 95,5 L da 91,1 a 97,4</b> Completo di meccanismo per lo scorrimento	Laminato* Laminate	TIM9LQ955
Finiture: piano folding disponibile in laminato*, Fenix, impiallacciato e Wood. Carico massimo supportato 80 kg (uniformemente distribuiti)	Fenix	TIM9FQ955
	Impiallacciato (Flavour/Clover/Luna) Veneered	TIM9IQ955
<b>GLIDE PENINSULA H 7,5 D 95,5 W from 91,1 to 97,4</b> Complete with sliding mechanism	Impiallacciato (Oltre) Veneered	TIM9IQ955
Finishes: available folding worktop in laminate, Fenix, veneered and Wood. Load capacity 80 kg (evenly distributed)	Wood	TIM9IQ955

\*per le finiture disponibili vedi sezione "Penisole squadrate" nel listino Top laminato  
see section "Squared peninsulas" in the Laminate worktop price list for available finishes

**N.B.: IL PIANO SCORREVOLE NON COPRE EVENTUALI ELETTRODOMESTICI PRESENTI NELLE BASI. NON DISPONIBILE PER FUORI MISURA.**  
**NOTE: SLIDING WORKTOP DON'T HIDE ANY APPLIANCES PRESENT IN THE BASE UNITS. CUSTOM SIZE NOT AVAILABLE.**

# Corner

PIANO SCORREVOLE SU TOP  
SLIDING TABLE ON WORKTOP

BASI - BASE UNITS ●

ISOLA/PENISOLA - ISLAND/PENINSULA ●



# “CORNER” - CARATTERISTICHE TECNICHE DEL MECCANISMO

## “CORNER” - TECHNICAL MECHANISM SPECIFICATION

### CARATTERISTICHE GUIDE - GUIDES FEATURES

#### FINITURA GUIDE GUIDES FINISH

- Inox bronzino
- Bronzino stainless steel

#### CARICO MASSIMO LOAD CAPACITY

- 60 kg equamente distribuiti
- 60 kg evenly distributed

#### TIPOLOGIA DI SCORRIMENTO SLIDES TYPE

- Cuscinetti a sfera
- Ball-bearing slide system

### DETTAGLI FUNZIONAMENTO - OPERATION DETAILS



Colore piano scorrevole: Fenix castoro - Sliding worktop colour: Fenix beaver  
Versione penisola: Corner DX - Version of peninsula: Corner RH



# “CORNER” - INGOMBRI E RIFERIMENTI LISTINO

## “CORNER” - TECHNICAL DIMENSIONS AND PRICE LIST



TABELLA DIMENSIONE “L”  
TABLE SIZE “L”

SP. FIANCO	L
1,2	91
1,8	91,6
2	91,8
2,2	92
2,4	92,2
3	92,8
7,5	97,3

(misure in cm)  
(size in cm)

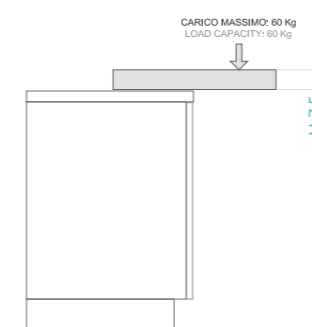

VISTA LATERALE  
SIDE VIEW

#### ATTENZIONE:

- LO SCORRIMENTO DELLA PENISOLA È DIAGONALE. È possibile installare le guide solamente in un'unica direzione: **destra o sinistra**
- **IN TUTTE LE SOLUZIONI INSERIRE SEMPRE IL FIANCO DI FINITURA LATERALE**

#### INSTRUCTIONS:

- THE PENINSULA SLIDING DIRECTION IS DIAGONAL. It is possible to install the guides in only one direction: **right or left side**
- **INSERT ALWAYS LATERAL FINISHING SIDE IN ALL SOLUTIONS**

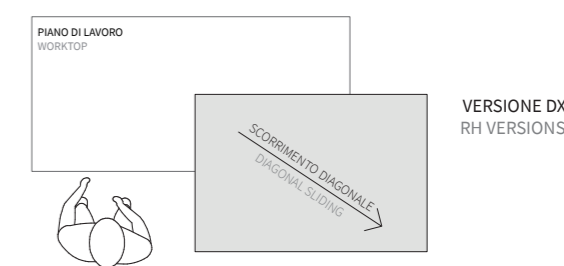
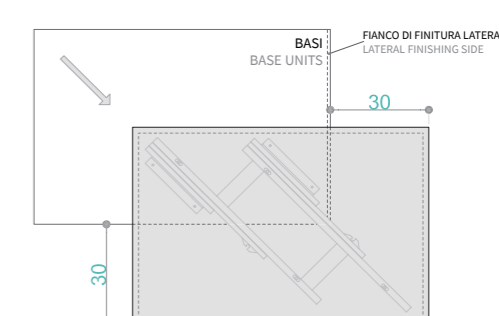

VERSIONE DX  
RH VERSIONS



VERSIONE SX  
LH VERSIONS

#### DESCRIZIONE MODELLO MODEL DESCRIPTION

#### FINITURA ESTERNA EXTERNAL FINISH

#### CODICE CODE No.

#### PENISOLA CORNER H 7,5 P 61 L da 91 a 97,3

Completo di meccanismo per lo scorrimento

Laminato\*  
Laminate

TIM9RL611/2

Finiture: piano folding disponibile in laminato\*, Fenix, impiallacciato e Wood.  
Carico massimo supportato 80 kg (uniformemente distribuiti)

Fenix

TIM9RF611/2

Impiallacciato  
(Flavour/Clover/Luna)  
Veneered

TIM9RI611/2

#### CORNER PENINSULA H 7,5 D 61 W from 91 to 97,3

With sliding mechanism

Impiallacciato  
(Oltre)  
Veneered

TIM9RI611/2

Finishes: available folding worktop in laminate, Fenix, veneered and Wood.  
Load capacity 80 kg (evenly distributed)

Wood

TIM9RI611/2

\*per le finiture disponibili vedi sezione “Penisole squadrate” nel listino Top laminato  
see section “Squared peninsulas” in the Laminate worktop price list for available finishes

N.B.: LA BASE DEVE ESSERE ANCORATA OBBLIGATORIAMENTE A MURO TRAMITE ATTACCAGGIE IN DOTAZIONE. NON DISPONIBILE PER FUORI MISURA.  
NOTE: THE BASE UNIT MUST NECESSARILY BE ANCHORED TO THE WALL USING THE SUPPLIED HANGERS. CUSTOM SIZE NOT AVAILABLE.

# Quick

PIANO SCORREVOLE SU TOP  
SLIDING TABLE ON WORKTOP

ISOLA/PENISOLA - ISLAND/PENINSULA ●



# “QUICK” - CARATTERISTICHE TECNICHE DEL MECCANISMO

## “QUICK” - TECHNICAL MECHANISM SPECIFICATION

### CARATTERISTICHE GUIDE - GUIDES FEATURES

#### FINITURA GUIDE GUIDES FINISH

- Anodizzato naturale - Grigio satinato
- Anodized aluminium - Satin gray

#### CARICO MASSIMO LOAD CAPACITY

- 80 kg equamente distribuiti
- 80 kg evenly distributed

#### TIPOLOGIA DI SCORRIMENTO SLIDES TYPE

- Cuscinetti a sfera
- Ball-bearing slide system

### DETTAGLI FUNZIONAMENTO - OPERATION DETAILS



Colore piano scorrevole: Rovere fumè - Sliding worktop colour: Smoked oak



# “QUICK”- INGOMBRI E RIFERIMENTI LISTINO

## “QUICK”- TECHNICAL DIMENSIONS AND PRICE LIST

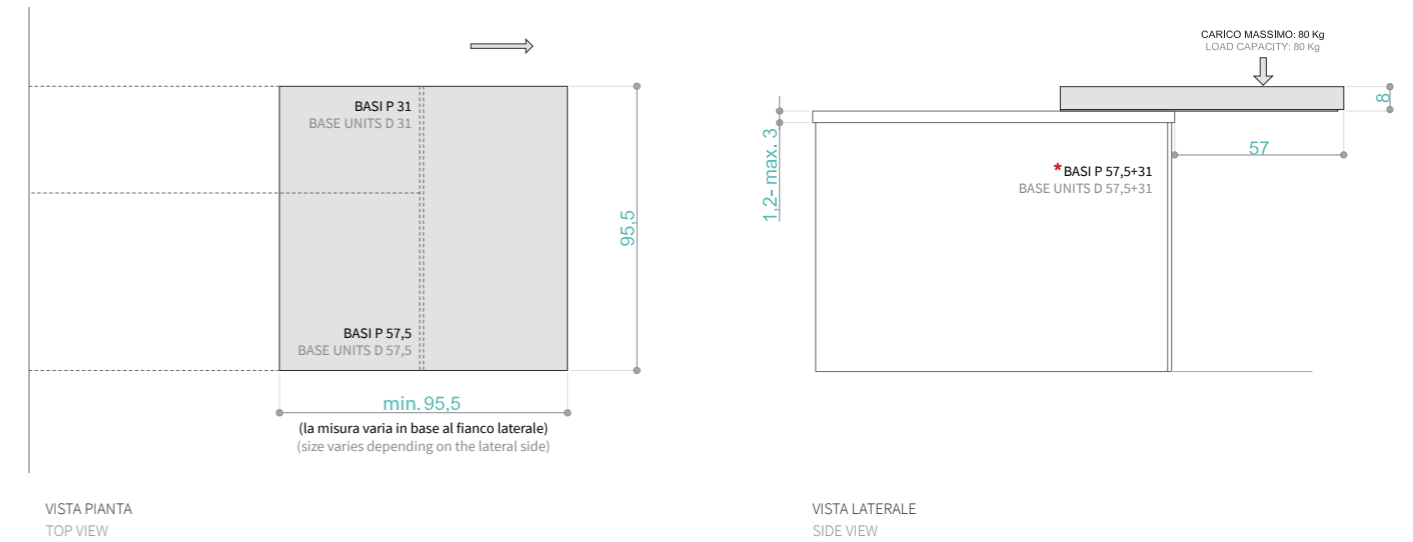

\*N.B.: NELLA PARTE SOTTOSTANTE LA PENISOLA È OBBLIGATORIO INSERIRE UNA COMPOSIZIONE DI BASI P 57,5 + P 31  
NOTE: BELOW THE PENINSULA IT IS REQUIRED TO INSERT A COMPOSITION OF BASE UNITS D 57,5 + D 31

#### DESCRIZIONE MODELLO MODEL DESCRIPTION

#### FINITURA FINISH

#### CODICE CODE No.

#### PIANO SCORREVOLE SU TOP

Completo di meccanismo per lo scorrimento

Laminato  
Laminate

TIM8LQ955

Finiture: piano disponibile nelle finiture laminato, Fenix, impiallacciato e Wood.

Fenix

TIM8FQ955

Note: carico massimo supportato 80 kg (uniformemente distribuiti)

Impiallacciato  
(Flavour/Clover/Luna)  
Veneered

TIM8IQ955

#### SLIDING TABLE WORKTOP

With sliding mechanism

Impiallacciato  
(Oltre)  
Veneered

TIM8IQ955

Finishes: worktop finishes available laminate, Fenix, veneered and Wood.

Note: load capacity 80 kg (evenly distributed)

Wood

TIM8IQ955

Maggiorazione per installazione su top ceramici/compositi/graniti e marmi

T9FSC

Surcharge for placement on worktops ceramic/composite/granite and marble

N.B.: PIANO SCORREVOLE NON DISPONIBILE PER FUORI MISURA. NON È POSSIBILE INSTALLARE ELETTRODOMESTICI NELLE BASI INFERIORI  
NOTE: SLIDING WORKTOP NOT AVAILABLE FOR CUSTOM SIZES. IT IS NOT POSSIBLE TO INSTALL APPLIANCES ON THE LOWERED BASE UNITS

# Swift

PIANO SCORREVOLE SU TOP  
SLIDING TABLE ON WORKTOP

ISOLA/PENISOLA - ISLAND/PENINSULA ●



# “SWIFT” - CARATTERISTICHE TECNICHE DEL MECCANISMO

## “SWIFT” - TECHNICAL MECHANISM SPECIFICATION

### CARATTERISTICHE GUIDE - GUIDES FEATURES

#### FINITURA GUIDE GUIDES FINISH

- Anodizzato naturale - Grigio satinato
- Anodized aluminium - Satin gray

#### CARICO MASSIMO LOAD CAPACITY

- 80 kg equamente distribuiti
- 80 kg evenly distributed

#### TIPOLOGIA DI SCORRIMENTO SLIDES TYPE

- Cuscinetti a sfera
- Ball-bearing slide system

### DETTAGLI FUNZIONAMENTO - OPERATION DETAILS



Colore piano scorrevole: Bronzo doha - Sliding worktop colour: Bronzo doha



# “SWIFT” - INGOMBRI E RIFERIMENTI LISTINO

## “SWIFT” - TECHNICAL DIMENSIONS AND PRICE LIST

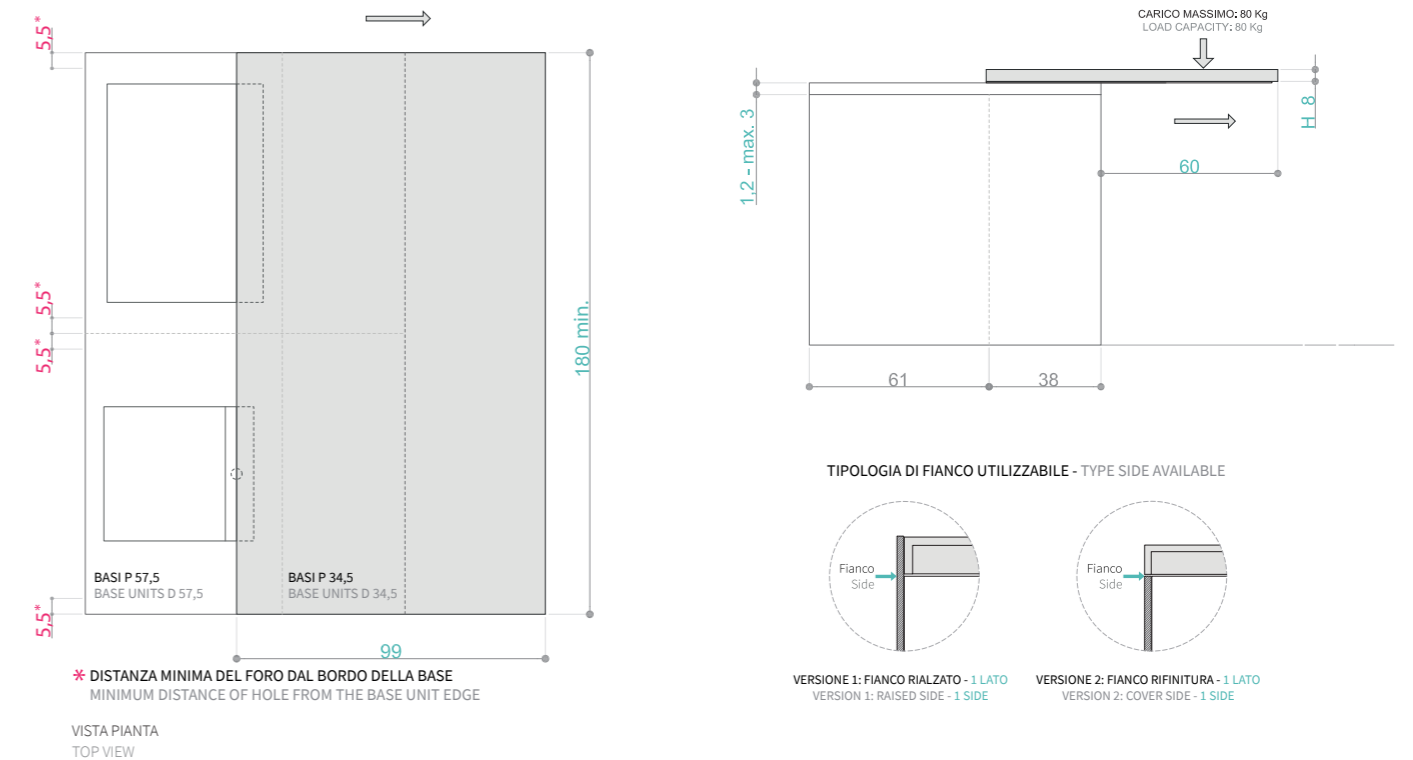

**N.B.: NELLA PARTE SOTTOSTANTE LA PENISOLA È OBBLIGATORIO INSERIRE UNA COMPOSIZIONE DI BASI P 57,5 + P 34,5**  
**NOTE: BELOW THE PENINSULA IT IS REQUIRED TO INSERT A COMPOSITION OF BASE UNITS D 57,5 + D 34,5**

#### DESCRIZIONE MODELLO MODEL DESCRIPTION

#### FINITURA FINISH

#### CODICE CODE No.

#### PIANO SCORREVOLE SU TOP

Completo di meccanismo per lo scorrimento

Laminato  
Laminate

TIM7LQ985

Finiture: piano disponibile nelle finiture laminato, Fenix, impiallacciato e Wood.

Fenix

TIM7IQ985

Note: carico massimo supportato 80 kg (uniformemente distribuiti).  
 Tra elettrodomestici e fondo penisola è disponibile 1 cm di spazio.

Impiallacciato  
(Flavour/Clover/Luna)  
Veneered

TIM7IQ985

#### SLIDING TABLE WORKTOP

With sliding mechanism

Impiallacciato  
(Oltre)  
Veneered

TIM7IQ985

Finishes: worktop finishes available laminate, Fenix, veneered and Wood.

Wood

TIM7FQ985

Note: load capacity 80 kg (evenly distributed).  
 Available space 1 cm between appliances and the bottom peninsula.



**N.B.: obbligatorio l'inserimento gruppo rubinetto periscopico**  
**Note: obligatory insert periscope group tap**

**N.B.: PIANO SCORREVOLE NON DISPONIBILE PER FUORI MISURA. È POSSIBILE INSTALLARE SOLO DUE ELETTRODOMESTICI NELLE BASI INFERIORI**  
**NOTE: SLIDING WORKTOP NOT AVAILABLE FOR CUSTOM SIZES. IT IS POSSIBLE TO INSTALL ONLY TWO APPLIANCES ON THE LOWERED BASE UNITS**



# Line-N

PIANO SCORREVOLE SU TOP  
SLIDING TABLE ON WORKTOP

ISOLA/PENISOLA - ISLAND/PENINSULA ●



# “LINE-N” - CARATTERISTICHE TECNICHE DEL MECCANISMO

## “LINE-N” - TECHNICAL MECHANISM SPECIFICATION

### CARATTERISTICHE GUIDE - GUIDES FEATURES

#### FINITURA GUIDE GUIDES FINISH

- Anodizzato naturale - Grigio satinato
- Anodized aluminium - Satin gray

#### CARICO MASSIMO LOAD CAPACITY

- 60 kg equamente distribuiti
- 60 kg evenly distributed

#### TIPOLOGIA DI SCORRIMENTO SLIDES TYPE

- Cuscinetti a sfera
- Ball-bearing slide system

### DETTAGLI FUNZIONAMENTO - OPERATION DETAILS



Colore piano scorrevole: Rovere moscato - Sliding worktop colour: Moscato oak



# “LINE-N” - INGOMBRI E RIFERIMENTI LISTINO

## “LINE-N” - TECHNICAL DIMENSIONS AND PRICE LIST

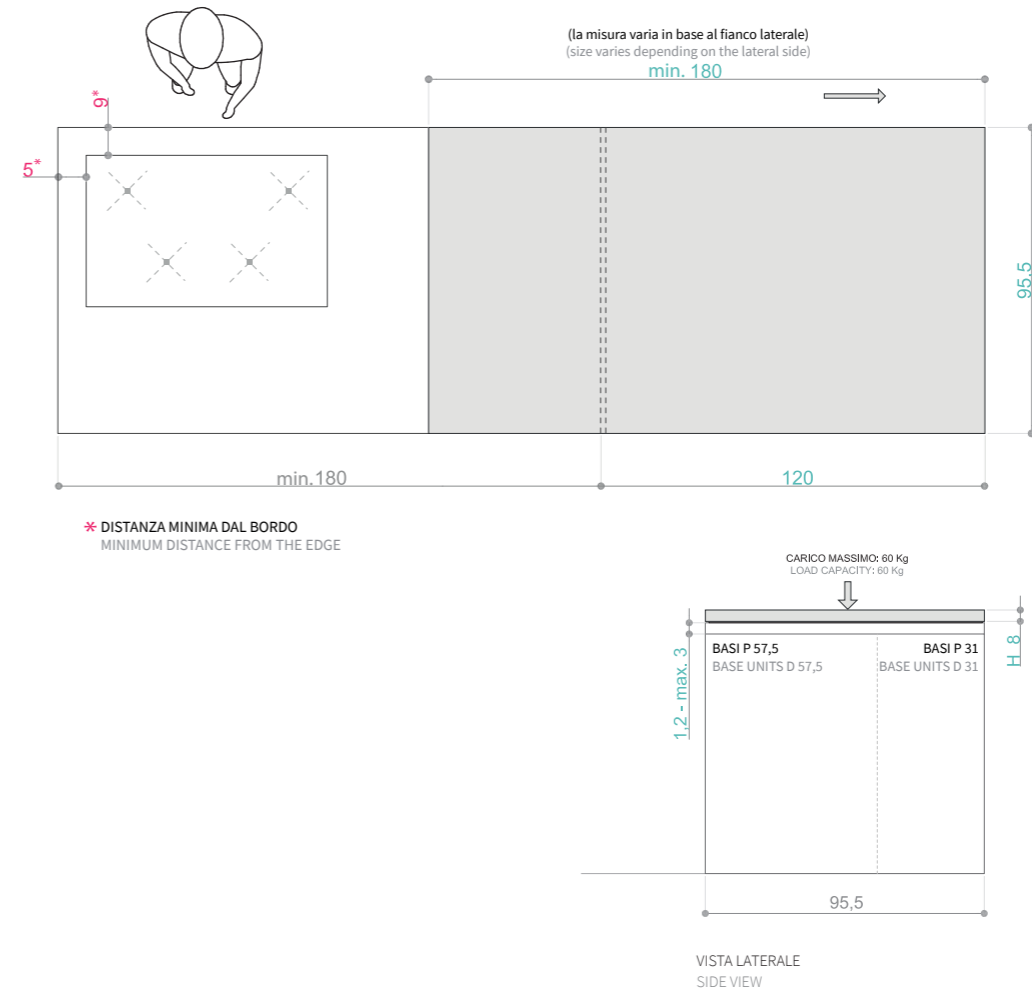

N.B.: NELLA PARTE SOTTOSTANTE LA PENISOLA È OBBLIGATORIO INSERIRE UNA COMPOSIZIONE DI BASI P 57,5 + P 31  
NOTE: BELOW THE PENINSULA IT IS REQUIRED TO INSERT A COMPOSITION OF BASE UNITS D 57,5 + D 31

DESCRIZIONE MODELLO MODEL DESCRIPTION	FINITURA FINISH	CODICE CODE No.
<b>PIANO SCORREVOLE SU TOP</b> Completo di meccanismo per lo scorrimento	Laminato Laminate	TIM67L955
	Fenix	TIM67F955
Finiture: piano disponibile nelle finiture laminato, Fenix, impiallacciato e Wood. Note: carico massimo supportato 60 kg (uniformemente distribuiti). Tra elettrodomestici e fondo penisola è disponibile 1 cm di spazio	Impiallacciato (Flavour/Clover/Luna) Veneered	TIM67I955
	Impiallacciato (Oltre) Veneered	TIM67I955
<b>SLIDING TABLE WORKTOP</b> With sliding mechanism	Impiallacciato (Oltre) Veneered	TIM67I955
Finishes: worktop finishes available laminate, Fenix, veneered and Wood. Note: load capacity 60 kg (evenly distributed). Available space 1 cm between appliances and the bottom peninsula.	Wood	TIM67I955

N.B.: PIANO SCORREVOLE NON DISPONIBILE PER FUORI MISURA. È POSSIBILE INSTALLARE UN SOLO ELETTRODOMESTICO NELLA BASE INFERIORE  
NOTE: SLIDING WORKTOP NOT AVAILABLE FOR CUSTOM SIZES. IT IS POSSIBLE TO INSTALL ONLY ONE APPLIANCE ON THE LOWERED BASE UNIT

	Flap	Lunch	Dual	Skip N	Skip S	Party	Desk	Extra/Slicer	Flux	Dais	Bow	Sled	Open
<b>Collezione Lube</b>													
<b>Adele project</b>	•			•	•	•	•	•	•	•	•	•	•
Clover			•	•	•	•	•	•	•	•	•	•	•
<b>Design Collection</b>													
Gallery	•	•		•	•	•	•	•	•	•	•	•	•
Immagina	•	•	•	•	•	•	•	•	•	•	•	•	•
Luna	•	•	•	•	•	•	•	•	•	•	•	•	•
Unica	•	•	•	•	•	•	•	•	•	•	•	•	•
Round	•	•	•	•	•	•	•	•	•	•	•	•	•
Claudia	•	•	•	•	•	•	•	•	•	•	•	•	•
Agnese	•	•	•	•	•	•	•	•	•	•	•	•	•
Laura	•	•	•	•	•	•	•	•	•	•	•	•	•
Flavour	•	•	•	•	•	•	•	•	•	•	•	•	•
Veronica	•	•	•	•	•	•	•	•	•	•	•	•	•
Oltre	•	•	•	•	•	•	•	•	•	•	•	•	•
<b>Collezione Creo</b>													
Tablet	•	•	•	•	•	•	•	•	•	•	•	•	•
Jey feel	•	•	•	•	•	•	•	•	•	•	•	•	•
Kyra	•	•	•	•	•	•	•	•	•	•	•	•	•
Smart	•	•	•	•	•	•	•	•	•	•	•	•	•
Contempo	•	•	•	•	•	•	•	•	•	•	•	•	•
Iris		•		•	•	•	•	•	•	•	•	•	•
Grace	•	•	•	•	•	•	•	•	•	•	•	•	•
Aurea	•	•	•	•	•	•	•	•	•	•	•	•	•
Oprah	•	•	•	•	•	•	•	•	•	•	•	•	•
Ank	•	•	•	•	•	•	•	•	•	•	•	•	•
Revind	•	•	•	•	•	•	•	•	•	•	•	•	•

\* MODELLI DISPONIBILI ANCHE CON MODULO 84 E PIEDE H 6