



GRUPPO LUBE



# SISTEMI D'ARREDO

## FURNITURE SYSTEMS

---

CUCINE  
**LUBE**

GRUPPO LUBE

**CREO**  
KITCHENS

# Multiplo





**“MULTIPLO”**  
“MULTIPLO”



# SISTEMA MODULARE “MULTIPLO”

MODULAR SYSTEM “MULTIPLO”

“MULTIPLO” è un sistema multifunzionale con struttura in alluminio, che permette la realizzazione di strutture a giorno. La versatilità del sistema e la sua semplicità consistono nella facilità di montaggio e nell’essenzialità dell’estetica, rendendolo perfetto per ogni ambiente.

“MULTIPLO” is a multifunctional system with aluminium structure, that allow to create opened structure solutions. The versatility and the simplicity of this project lay in the essential look and its easy to assemble nature, making it perfect for every space.



ESEMPIO DI VERSIONE LIBRERIA A PARETE CON KIT LUCE LED DUAL COLOR  
EXAMPLE OF THE WALL BOOKCASE VERSION WITH DUAL COLOR LED LIGHT KIT

# SISTEMA MODULARE "MULTIPLO"

## MODULAR SYSTEM "MULTIPLO"

Disponibile in 4 VERSIONI DIFFERENTI

Available in 4 DIFFERENT VERSIONS

### SOTTOPENSILE UNDER WALL UNIT



### SOSPESO HANGING



### LIBRERIA A PARETE WALL BOOKCASE



### TERMINALE END UNIT



### FINITURE DISPONIBILI PER STRUTTURA AVAILABLE STRUCTURE FINISHES



nero (opt.7892)  
black (opt.7892)



silver dark (opt.9507)  
dark silver (opt.9507)



grigio selce (opt.SEL)  
flint grey (opt.SEL)

**N.B.: PER IL MONTAGGIO CONSULTARE  
L'APPOSITO LIBRETTO DI ISTRUZIONI**  
NOTE: SEE INSTRUCTION MANUAL FOR ASSEMBLY

# “MULTIPLO” SOTTOPENSILE

“MULTIPLO” UNDER WALL UNIT

Struttura modulare in alluminio con piastre per fissaggio a parete e installazione tra pensile e base. Completa di supporti e traversi orizzontali per aggancio di mensole disponibili in versione melaminico, laccato opaco e metallo.

Possibilità di inserire il kit luce led Dual Color con telecomando nella parte posteriore dei montanti.

Disponibile nelle larghezze L 60-90 cm e nell'altezza H 36 cm. Portata massima 20 kg (per ogni mensola).

Modular aluminium wall-mounted structure with plates for the placement between wall unit and base unit.

Included supports and horizontal beams for melamine, matt lacquered and metal shelves.

Possibility to insert Dual Color led light kit with remote control in the rear of pillars.

Available in widths W 60-90 cm and in height H 36 cm. Load capacity 20 kg (for each shelf).

VISTA FRONTALE  
FRONT VIEW

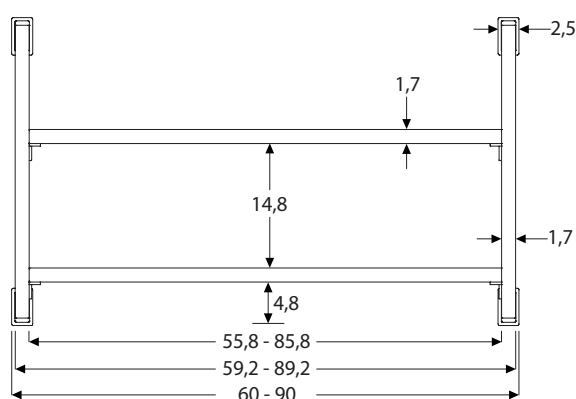

VISTA LATERALE  
SIDE VIEW

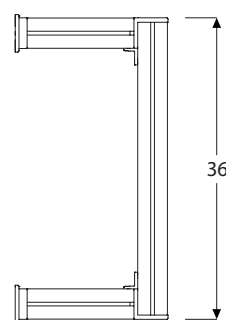

VISTA SUPERIORE  
TOP VIEW

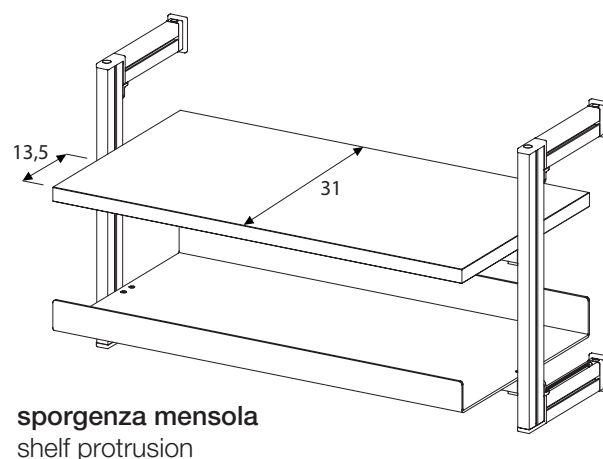
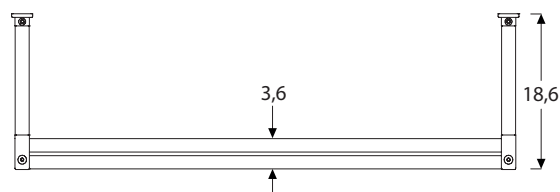

Disponibili mensole in melaminico/laccato opaco e in metallo di L 55,8 e L 85,8 P 31 cm (vedi pag.12). Per schema montanti con kit luce led Dual Color e alimentatori (vedi pag.13).

Available melamine/matt lacquered and metal shelves W 55,8 and W 85,8 D 31 cm (see page 12).

Diagram pillars with Dual Color led light kit and power supplies (see page 13).

## “MULTIPLO” SOTTOPENSILE

“MULTIPLO” UNDER WALL UNIT

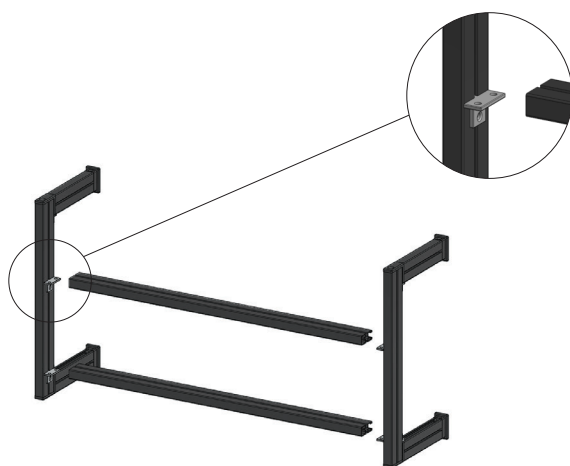

Struttura singola composta da:

- montante sx con supporti e traversi orizzontali nr.2 per H 36

- montante dx con supporti (per fine composizione)

Single structure consist of:

- LH pillar with supports and horizontal beams nr.2 for H 36

- RH pillar with supports (for end composition)

H 36 L 60 08902401

H 36 L 90 08902403

**Magg. kit luce led Dual Color (per 2 montanti)**

Surcharge led light kit Dual Color (for 2 pillars) H

36 opz.002

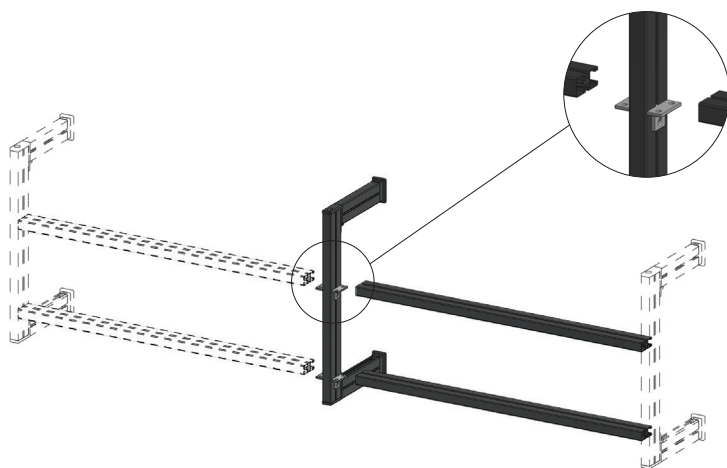

Struttura centrale composta da:

- montante centrale con supporti e traversi orizzontali nr.2 per H 36

Central structure consist of:

- central pillar with supports and horizontal beams nr.2 for H 36

H 36 L 57,9 08902401C

H 36 L 87,9 08902403C

**Magg. kit luce led Dual Color (per 1 montante)**

Surcharge led light kit Dual Color (for 1 pillar)

H 36 opz.002

Per esempi di modularità vedi pag. 18-20.

**N.B.: nella realizzazione di composizioni con struttura singola e centrale il montante dx deve essere sempre spostato a fine composizione.**

**(ACCESSORIO PORTABOTTIGLIE NON DISPONIBILE)**

For modularity examples see page 18-20.

**Note: RH pillar must always be moved at the end of the composition when there are single and central structures (BOTTLES RACK ACCESSORY NOT AVAILABLE)**

# “MULTIPLO” SOSPESO

“MULTIPLO” HANGING

Struttura modulare in alluminio con piastre per fissaggio a parete. Completa di supporti e traversi orizzontali per aggancio di mensole disponibili in versione melaminico, laccato opaco e metallo. Possibilità di inserire il kit luce led Dual Color con telecomando nella parte posteriore dei montanti. Disponibile nelle larghezze L 60-90 cm e nelle altezze H 108-180 cm.

Portata massima 20 kg (per ogni mensola).

Modular aluminium wall-mounted structure with plates. Included supports and horizontal beams for melamine, matt lacquered and metal shelves. Possibility to insert Dual Color led light kit with remote control in the rear of pillars. Available in widths W 60-90 cm and in heights H 108-180 cm. Load capacity 20 kg (for each shelf).

VISTA FRONTALE  
FRONT VIEW

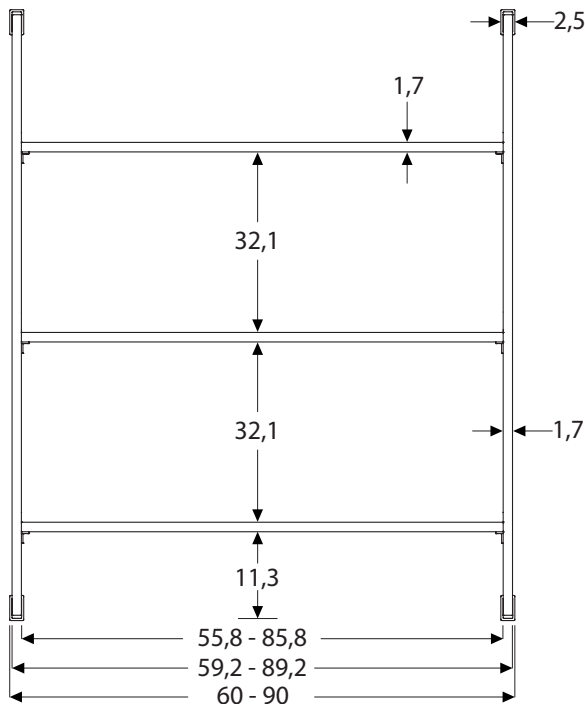

VISTA LATERALE  
SIDE VIEW

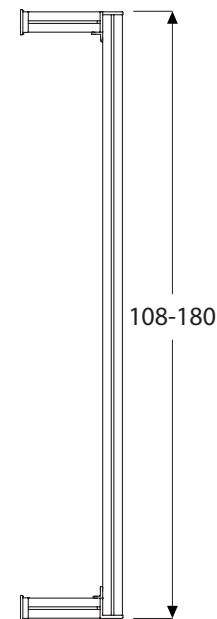

VISTA SUPERIORE  
TOP VIEW

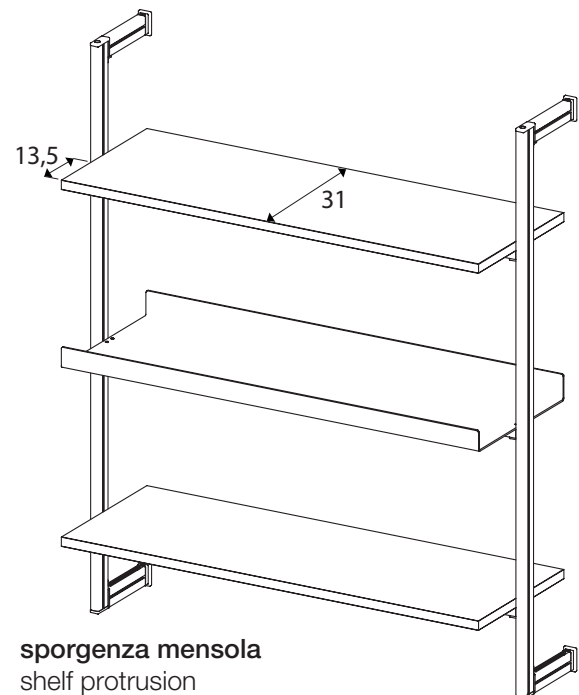
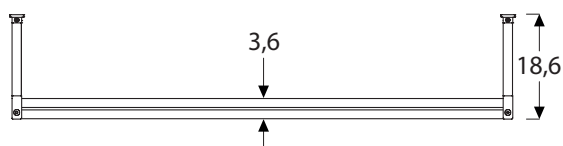

Disponibili mensole in melaminico/laccato opaco e in metallo di L 55,8 e L 85,8 P 31 cm (vedi pag.12). Per schema montanti con kit luce led Dual Color e alimentatori (vedi pag.13).

Available melamine/matt lacquered and metal shelves W 55,8 and W 85,8 D 31 cm (see page 12).

Diagram pillars with Dual Color led light kit and power supplies (see page 13).



# “MULTIPLO” SOSPESO

## “MULTIPLO” HANGING

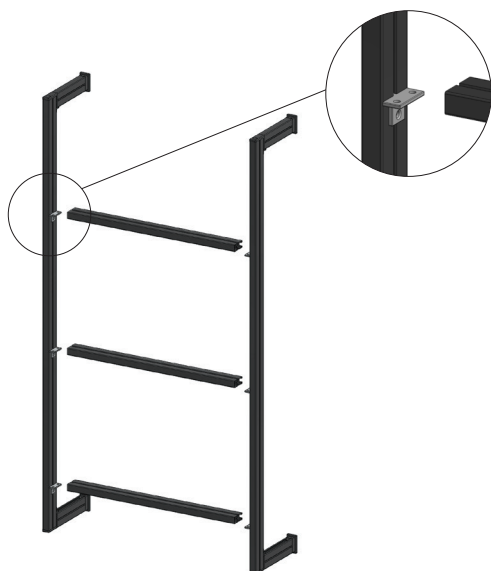

### Struttura singola composta da:

- montante sx con supporti e traversi orizzontali  
nr.3 per H 108  
nr.5 per H 180

- montante dx con supporti (per fine composizione)

Single structure consist of:

- LH pillar with supports and horizontal beams  
nr.3 for H 108  
nr.5 for H 180
- RH pillar with supports (for end composition)

H 108 L 60 08902405

H 108 L 90 08902407

H 180 L 60 08902411

H 180 L 90 08902413

### Magg. kit luce led Dual Color (per 2 montanti)

Surcharge led light kit Dual Color (for 2 pillars)

H 108 opz.002

H 180 opz.002

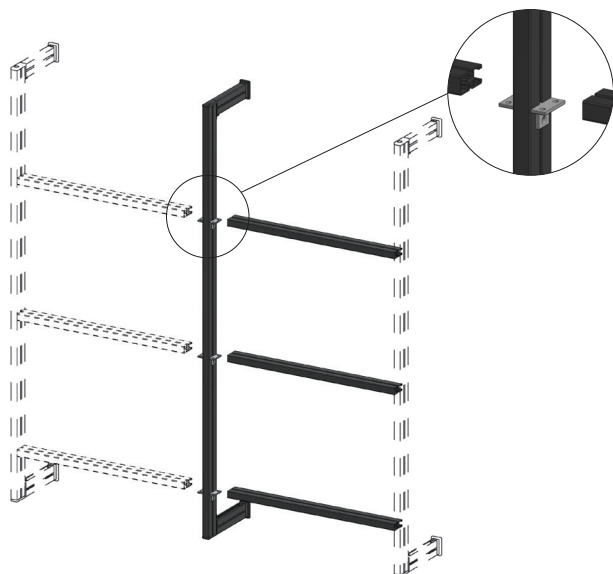

### Struttura centrale composta da:

- montante centrale con supporti e traversi orizzontali  
nr.3 per H 108  
nr.5 per H 180

Central structure consist of:

- central pillar with supports and horizontal beams  
nr.3 for H 108  
nr.5 for H 180

H 108 L 57,9 08902405C

H 108 L 87,9 08902407C

H 180 L 57,9 08902411C

H 180 L 87,9 08902413C

### Magg. kit luce led Dual Color (per 1 montante)

Surcharge led light kit Dual Color (for 1 pillar)

H 108 opz.002

H 180 opz.002

Per esempi di modularità vedi pag. 18-20.

**N.B.: nella realizzazione di composizioni con struttura singola e centrale il montante dx deve essere sempre spostato a fine composizione.**

For modularity examples see page 18-20.

Note: RH pillar must always be moved at the end of the composition when there are single and central structures

# “MULTIPLO” LIBRERIA A PARETE

“MULTIPLO” WALL BOOKCASE

Struttura modulare in alluminio con appoggio a terra e piastre per fissaggio a parete. Completa di supporti e traversi orizzontali per aggancio di mensole disponibili in versione melaminico, laccato opaco e metallo. Possibilità di inserire il kit luce led Dual Color con telecomando nella parte posteriore dei montanti.

Disponibile nelle larghezze L 60-90 cm e nelle altezze H 217-222 cm. Portata massima 20 kg (per ogni mensola).

Modular ground aluminium structure with plates for fixing to wall. Included supports and horizontal beams melamine, matt lacquered and metal shelves. Possibility to insert Dual Color led light kit with remote control in the rear of pillars. Available in widths W 60-90 cm and in heights H 217-222 cm. Load capacity 20 kg (for each shelf).

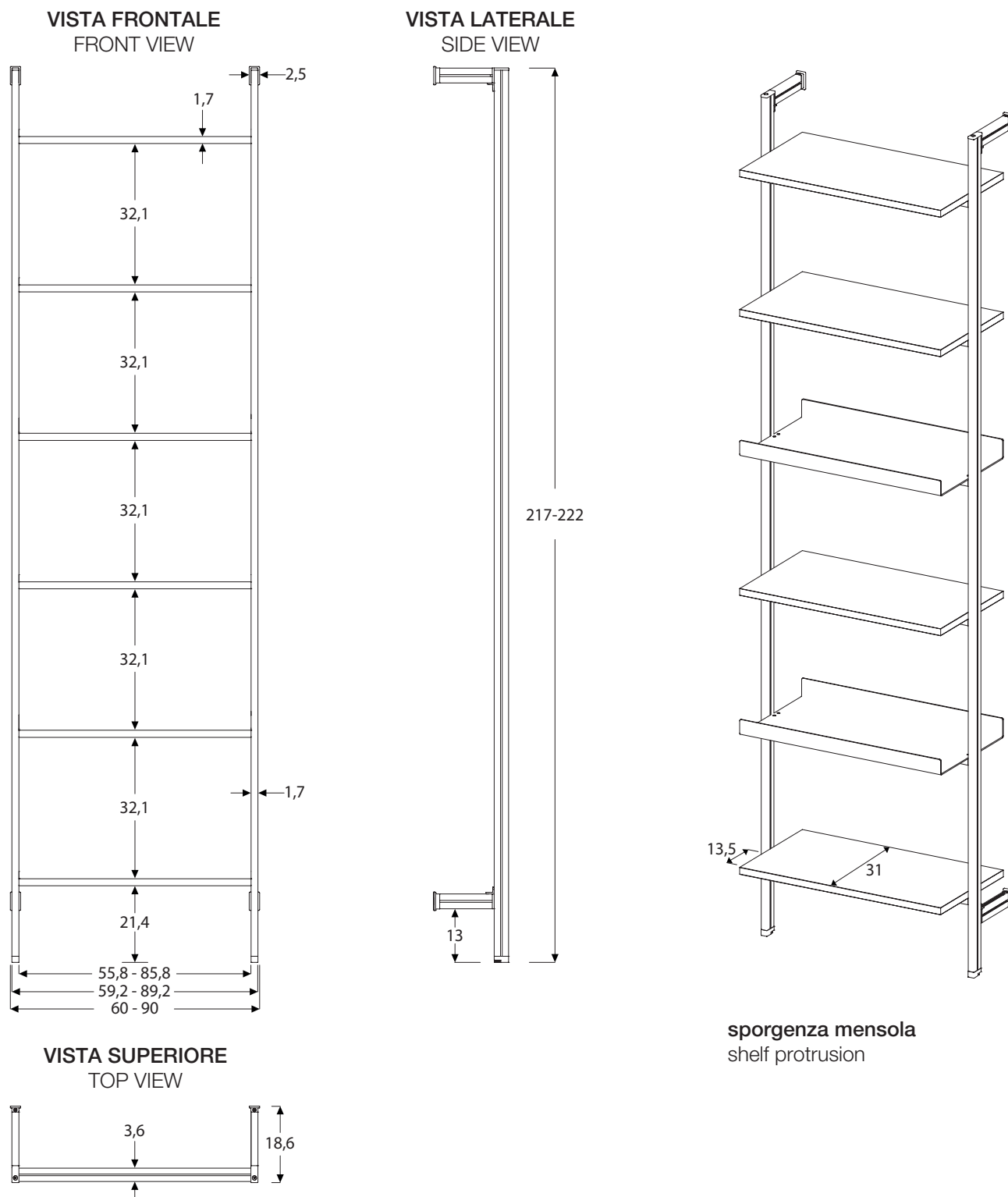

Disponibili mensole in melaminico/laccato opaco e in metallo di L 55,8 e L 85,8 P 31 cm (vedi pag.12). Per schema montanti con kit luce led Dual Color e alimentatori (vedi pag.13).

Available melamine/matt lacquered and metal shelves W 55,8 and W 85,8 D 31 cm (see page 12).

Diagram pillars with Dual Color led light kit and power supplies (see page 13).

# “MULTIPLO” LIBRERIA A PARETE

“MULTIPLO” WALL BOOKCASE

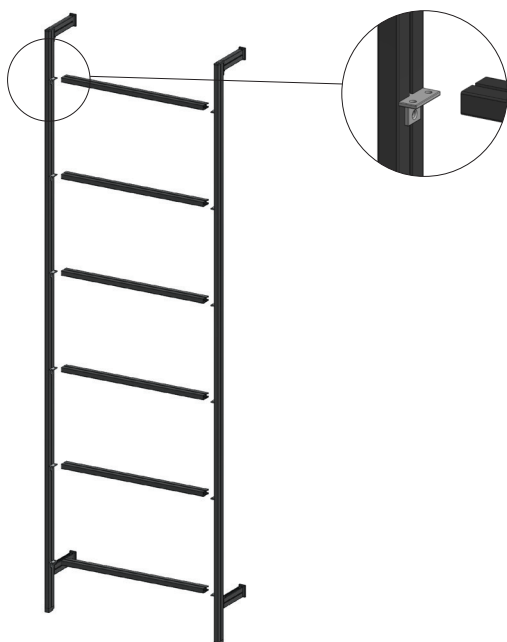

## Struttura singola composta da:

- montante sx con supporti e traversi orizzontali  
nr.6 per H 217  
nr.6 per H 222

- montante dx con supporti (per fine composizione)

Single structure consist of:

- LH pillar with supports and horizontal beams  
nr.6 for H 217  
nr.6 for H 222
- RH pillar with supports (for end composition)

H 217 L 60 08902421

H 217 L 90 08902423

H 222 L 60 08902425

H 222 L 90 08902427

## Magg. kit luce led Dual Color (per 2 montanti)

Surcharge led light kit Dual Color (for 2 pillars)

H 217 opz.002

H 222 opz.002

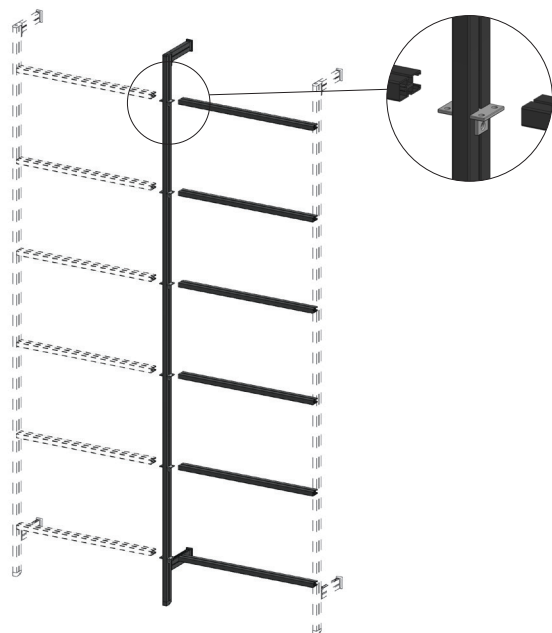

## Struttura centrale composta da:

- montante centrale con supporti e traversi orizzontali  
nr.6 per H 217  
nr.6 per H 222

Central structure consist of:

- central pillar with supports and horizontal beams  
nr.6 for H 217  
nr.6 for H 222

H 217 L 57,9 08902421C

H 217 L 87,9 08902423C

H 222 L 57,9 08902425C

H 222 L 87,9 08902427C

## Magg. kit luce led Dual Color (per 1 montante)

Surcharge led light kit Dual Color (for 1 pillar)

H 217 opz.002

H 222 opz.002

Per esempi di modularità vedi pag. 18-20.

**N.B.: nella realizzazione di composizioni con struttura singola e centrale il montante dx deve essere sempre spostato a fine composizione.**

For modularity examples see page 18-20.

Note: RH pillar must always be moved at the end of the composition when there are single and central structures

# “MULTIPLO” TERMINALE

“MULTIPLO” END UNIT

Struttura singola in alluminio con piastre per fissaggio su fianco base/colonna e installazione a fine composizione. Completa di supporti e traversi orizzontali per aggancio di mensole disponibili in versione melaminico, laccato opaco e metallo. Disponibile nella larghezza L 45 cm e nelle altezze H 60-108-180 cm.

Portata massima 20 kg (per ogni mensola). **NON MODULABILE.**

Single aluminium structure mounted on side of the base unit/column at the end of the composition.

Included supports and horizontal beams for melamine, matt lacquered and metal shelves.

Available in width W 45 cm and in heights H 60-108-180 cm. Load capacity 20 kg (for each shelf). **NOT ADJUSTABLE.**

VISTA FRONTALE  
FRONT VIEW

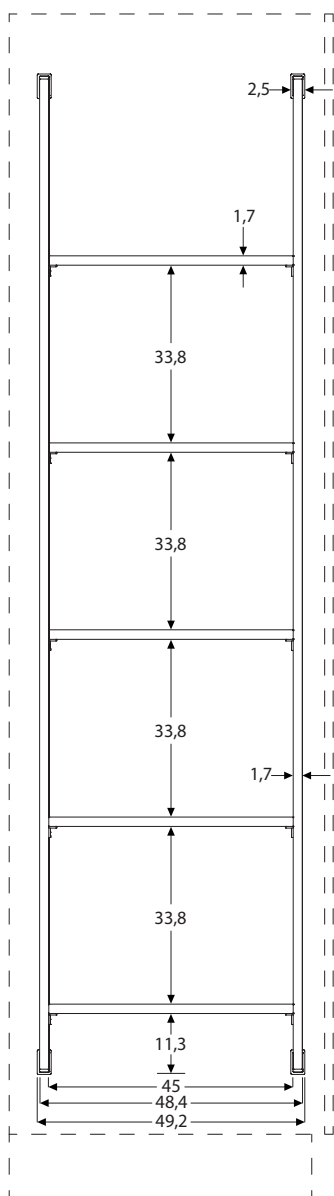

VISTA LATERALE  
SIDE VIEW

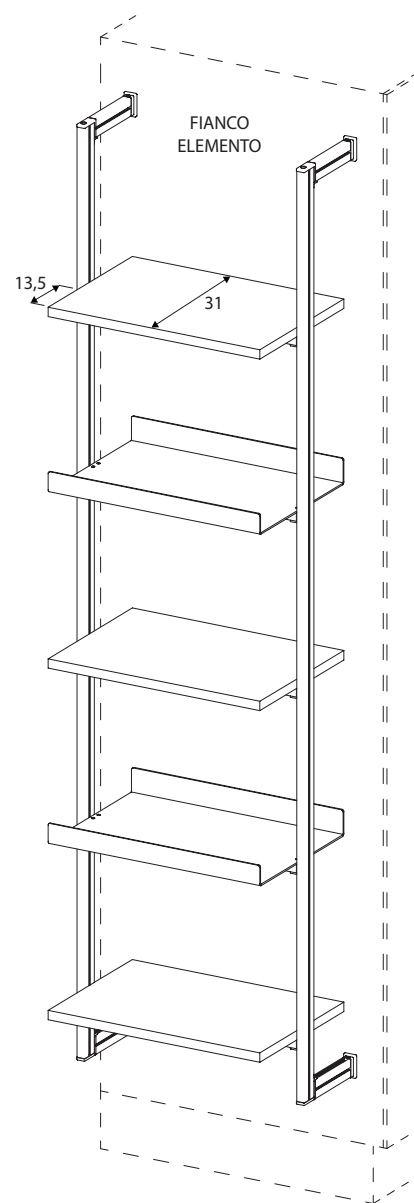
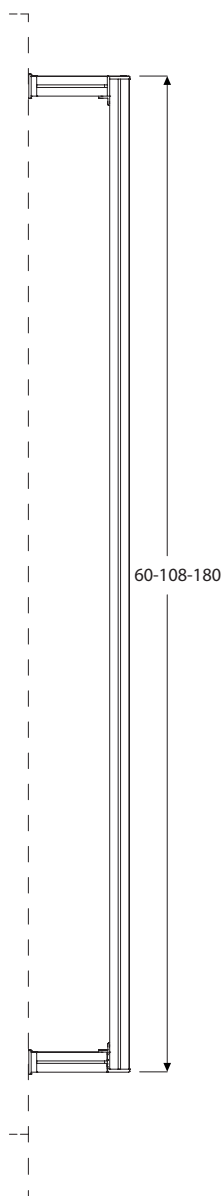

sporgenza mensola  
shelf protrusion

VISTA SUPERIORE  
TOP VIEW

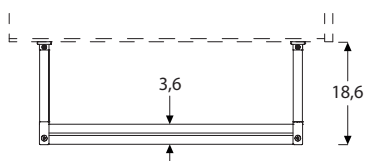

Disponibili mensole in melaminico/laccato opaco e in metallo di L 45 P 31 cm (vedi pag.12).

**N.B.: KIT LUCE LED E ACCESSORIO PORTABOTTIGLIE NON DISPONIBILE**

Available melamine/matt lacquered and metal shelves W 41 D 31 cm (see page 12).

Note: LED LIGHT KIT AND BOTTLES RACK ACCESSORY NOT AVAILABLE

# “MULTIPLO” TERMINALE

## “MULTIPLO” END UNIT

---

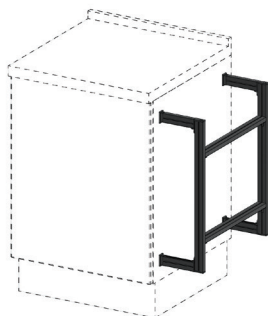

**Struttura singola H 60 L 45 composta da:**

- montante sx con supporti
- 2 traversi orizzontali
- montante dx con supporti

Single structure H 60 W 45 consist of:

- LH pillar with supports
- 2 horizontal beams
- RH pillar with supports

**H 60 L 45 08902260**

**Per basi H 72/75/84**  
For base units H 72/75/84

---

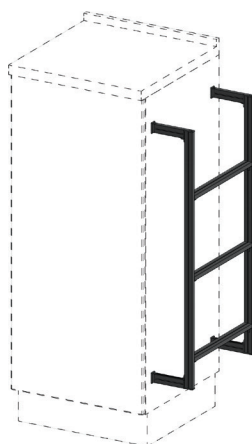

**Struttura singola H 108 L 45 composta da:**

- montante sx con supporti
- 3 traversi orizzontali
- montante dx con supporti

Single structure H 108 W 45 consist of:

- LH pillar with supports
- 3 horizontal beams
- RH pillar with supports

**H 108 L 45 08902263**

**Per colonne H 132/144**  
For columns H 132/144

---

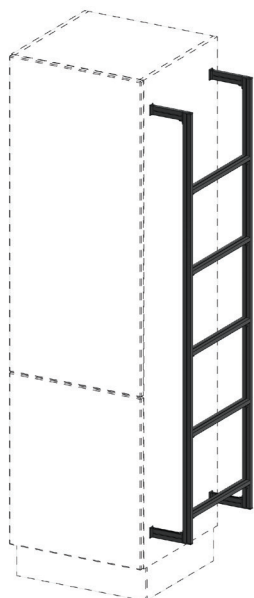

**Struttura singola H 180 L 45 composta da:**

- montante sx con supporti
- 5 traversi orizzontali
- montante dx con supporti

Single structure H 180 W 45 consist of:

- LH pillar with supports
- 5 horizontal beams
- RH pillar with supports

**H 180 L 45 08902265**

**Per colonne H 204/216**  
For columns H 204/216

## “MULTIPLO” ACCESSORI

“MULTIPLO” ACCESSORIES

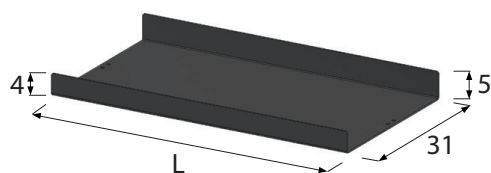

**Mensola in metallo P 31 SP.2 mm verniciata a polvere**  
Metal shelf D 31 th.2 mm powder painted

L 45 08902374  
L 55,8 08902375  
L 85,8 08902378

### Finiture disponibili

Available finishes



**nero (opz.7892)**  
black (opt.7892)

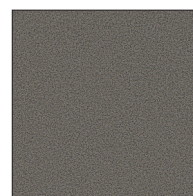

**silver dark (opz.9507)**  
dark silver (opt.9507)

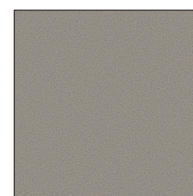

**grigio selce (opz.SEL)**  
flint grey (opt.SEL)

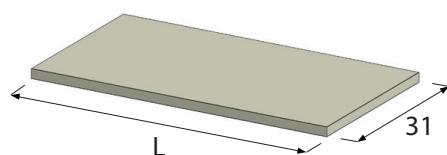

**Mensola P 31 SP.18 mm finitura come anta**

**N.B.: per le finiture vedi pag.14-17**

Shelf D 31 th.18 mm same finish as door

**Note: for the finishes see page 14-17**

### MELAMINICO

MELAMINE

L 45 08902384  
L 55,8 08902385  
L 85,8 08902388

### LACCATO OPACO

MATT LACQUERED

L 45 08902394  
L 55,8 08902395  
L 85,8 08902398

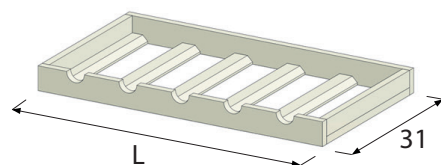

**Portabottiglie in legno P 31 laccato a poro aperto**  
**(completo di reggimensola a gradi)**

Wood bottles rack D 31 open-pore lacquer  
(complete with degree shelf brackets)

L 55,8 08902295  
L 85,8 08902298

### Finiture disponibili

Available finishes



**nero (opz.7892)**  
black (opt.7892)

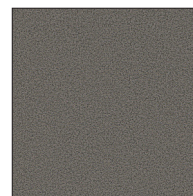

**silver dark (opz.9507)**  
dark silver (opt.9507)



**grigio selce (opz.SEL)**  
flint grey (opt.SEL)

# “MULTIPLIO” PROFILI LED DUAL COLOR PER MONTANTI

“MULTIPLIO” DUAL COLOR LED PROFILES FOR PILLARS

## Montanti SOTTOPENSILE

Pillars UNDER WALL UNIT

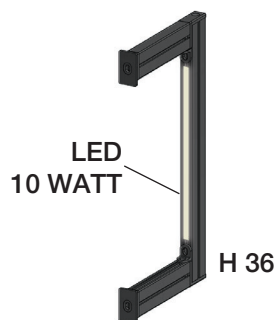

## Montanti LIBRERIA A PARETE

Pillars WALL BOOKCASE

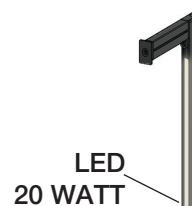
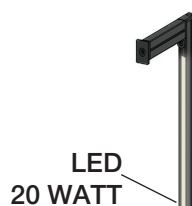

## Montanti SOSPESO

Pillars HANGING

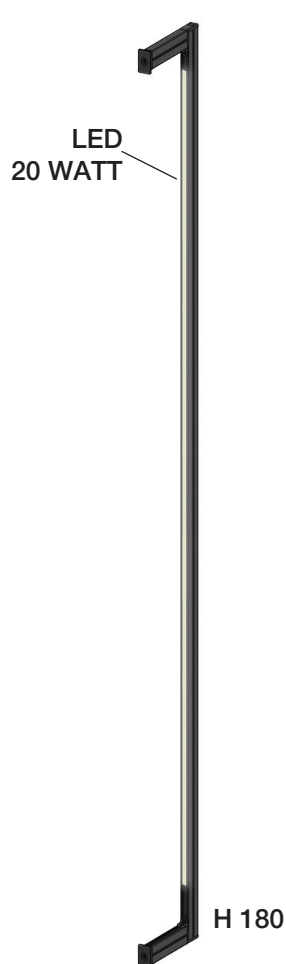
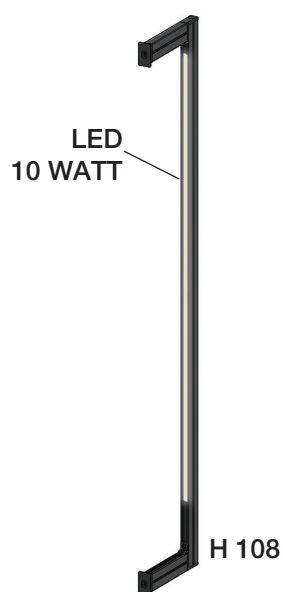

## KIT ALIMENTATORI con telecomando e staffa/POWER SUPPLIES KIT with remote control and bracket



(max.4 ingressi)  
(max.4 input)

### Mercato UE/UE Market

- 30 WATT 08902350

- 100 WATT 08902351

### Mercato Globale/Global Market

- 30 WATT 08902352

- 100 WATT 08902353

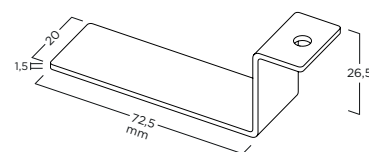

**Staffa per alimentatore**  
**(fissaggio sottomensola)**  
Bracket for power supply  
(fixing on the bottom of the shelf)

# “MULTIPLO” FINITURE MENSOLE SP.18 MM

“MULTIPLO” SHELVES FINISHES TH.18 MM

## FINITURE MELAMINICHE - MELAMINE FINISHES

### IMMAGINA PLUS



**cansiglio bianco**  
(opz.1561)  
white cansiglio



**cansiglio terra bruciata**  
(opz.1562)  
scorched earth cansiglio



**cansiglio grigio fumo**  
(opz.1563)  
smoke grey cansiglio



**cansiglio sabbia**  
(opz.1564)  
sand cansiglio



**cansiglio champagne**  
(opz.1565)  
champagne cansiglio



**larice baglia**  
(opz.1826)  
baglia larch



**larice laguna**  
(opz.1827)  
lagoon larch

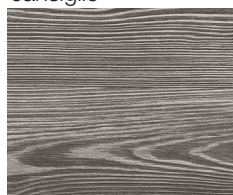

**larice vulcano**  
(opz.1828)  
volcano larch



**larice terra**  
(opz.1829)  
earth larch



**noce**  
(opz.2363)  
walnut



**cemento**  
(opz.9633)  
cement



**bianco cristallo**  
(opz.7445)  
cristal white

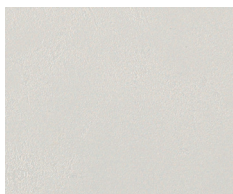

**grigio nebbia**  
(opz.9626)  
fog grey



**castoro**  
(opz.8862)  
beaver

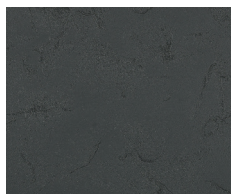

**lavagna**  
(opz.9627)  
slate grey



**juta**  
(opz.8863)  
jute



**bianco assoluto**  
(opz.7441)  
absolute white

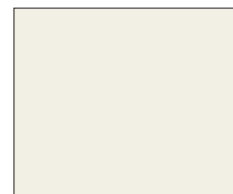

**bianco neve**  
(opz.750)  
snow white



**grigio sasso**  
(opz.9650)  
pebble grey



**verde marino**  
(opz.8402)  
sea green



**grigio monzone**  
(opz.9651)  
monsoon grey



**grigio notte**  
(opz.9652)  
midnight grey



**grigio velo**  
(opz.9653)  
veil grey

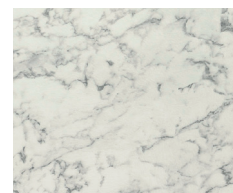

**marmo baron**  
(opz.9632)  
baron marble

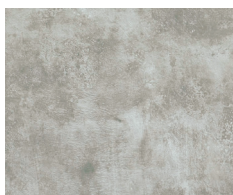

**nichel**  
(opz.9660)  
nickel

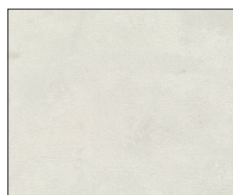

**platino**  
(opz.9661)  
platinum



**zinco**  
(opz.9662)  
zinc



**peltro**  
(opz.9666)  
pewter



**titanio**  
(opz.9665)  
titanium



**olmo bianco**  
(opz.5001)  
white elm



**olmo antracite**  
(opz.5004)  
anthracite elm



**oak miele**  
(opz.1361)  
honey oak



**oak neve**  
(opz.1362)  
snow oak



**oak cognac**  
(opz.1363)  
cognac oak



# “MULTIPLLO” FINITURE MENSOLE SP.18 MM

“MULTIPLLO” SHELVES FINISHES TH.18 MM

## FINITURE MELAMINICHE - MELAMINE FINISHES

### UNICA



**phagos nuvola**  
(opz.1567)  
phagos cloud



**phagos bianco**  
(opz.1566)  
phagos white

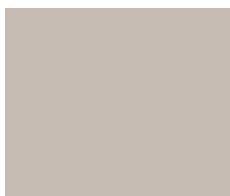

**dove grey**  
(opz.8971)  
grey dove



**phagos kapok**  
(opz.1560)  
phagos kapok



**rovere perla**  
(opz.5314)  
pearl oak



**pietra grey**  
(opz.9642)  
stone grey



**ecru**  
(opz.9641)  
ecru



**antracite**  
(opz.9643)  
anthracite



**bianco assoluto**  
(opz.7450)  
absolute white

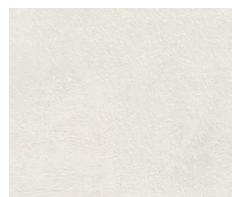

**platino**  
(opz.9661)  
platinum



**phagos vulcano**  
(opz.1568)  
phagos volcano



**pietra fulvus**  
(opz.8867)  
stone fulvus

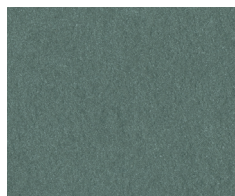

**pietra musk**  
(opz.8403)  
stone musk

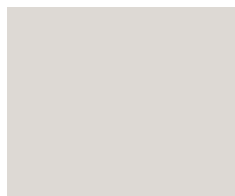

**grigio chiaro**  
(opz.9640)  
clear grey

# "MULTIPLO" FINITURE MENSOLE SP.18 MM

"MULTIPLO" SHELVES FINISHES TH.18 MM

## FINITURE MELAMINICHE - MELAMINE FINISHES

### TABLET



**rovere luna**  
(opz.5316)  
moon oak



**rovere venere**  
(opz.5315)  
venus oak



**rovere arizona**  
(opz.5317)  
arizona oak



**rovere dark**  
(opz.5318)  
dark oak



**frassino lava**  
(opz.2408)  
lava ash



**frassino sabbia**  
(opz.2406)  
sand ash



**frassino pietra**  
(opz.2407)  
stone ash



**noce brown**  
(opz.2371)  
brown walnut

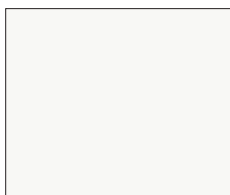

**bianco**  
(opz.7447N)  
white

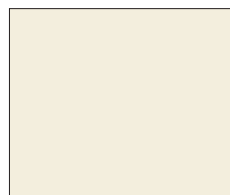

**porcellana**  
(opz.7703N)  
porcelain



**desert**  
(opz.8914N)  
desert



**molara**  
(opz.9636N)  
molara

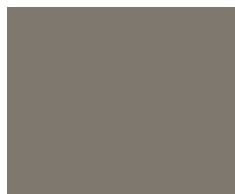

**arena**  
(opz.9637N)  
arena

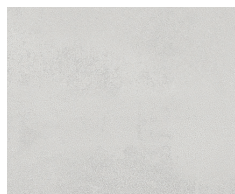

**bianco**  
(opz.9639)  
white



**bronzo**  
(opz.8866)  
bronze



**ardesia**  
(opz.9638)  
slate grey



**rovere tabià**  
(opz.5309)  
tabià oak



**rovere ortisei**  
(opz.5305)  
ortisei oak



**trani**  
(opz.7704)  
trani

# "MULTIPLO" FINITURE MENSOLE SP.18 MM

"MULTIPLO" SHELVES FINISHES TH.18 MM

## FINITURE MELAMINICHE - MELAMINE FINISHES

### JEY FEEL



**rovere silver**  
(opz.5306)  
silver oak



**rovere diamond**  
(opz.5307)  
diamond oak



**rovere tabià**  
(opz.5309)  
tabià oak



**rovere ortisei**  
(opz.5305)  
ortisei oak



**trani**  
(opz.7704)  
trani

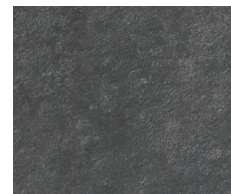

**black**  
(opz.7863)  
black

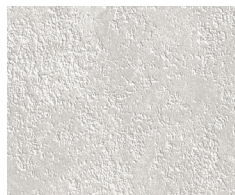

**white**  
(opz.7448)  
white



**grigio agata**  
(opz.9623)  
agata grey

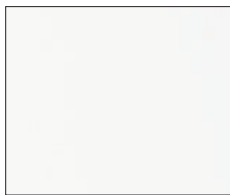

**bianco assoluto**  
(opz.7441)  
absolute white

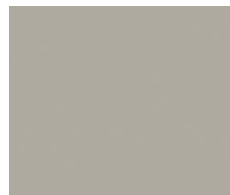

**grigio inox**  
(opz.9624)  
stainless steel grey

### SMART



**frassino bianco alpino**  
(opz.2310)  
alpine-white ash



**rovere greige**  
(opz.2320)  
greige oak



**betulla**  
(opz.2311)  
birch

## FINITURE LACCATE OPACHE - MATT LACQUERED FINISHES

Disponibili tutti i colori opachi del catalogo FINITURE LACCATE (GRUPPO LUBE)  
Available all matt colours of the LACQUERED FINISHES catalogue (GRUPPO LUBE)

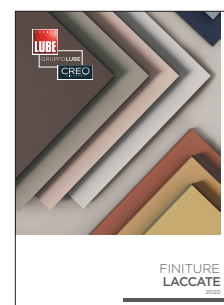

## “MULTIPLO” ESEMPI DI COMPONENTABILITÀ

“MULTIPLO” EXAMPLES OF MODULARITY

### ESEMPIO “MULTIPLO SOTTOPENSILE H 36 L 205”

EXAMPLE “MULTIPLO UNDER WALL UNIT H 36 W 205”

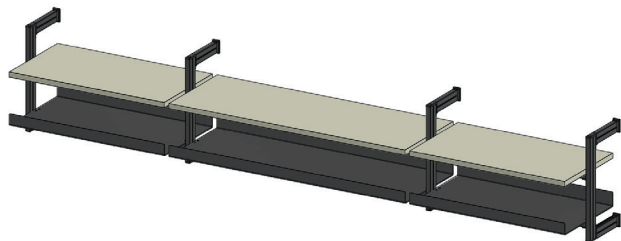

- **1 struttura singola H 36 L 60** 08902401  
1 single structure H 36 W 60
- **1 struttura centrale H 36 L 87,9** 08902403C  
1 central structure H 36 W 87,9
- **1 struttura centrale H 36 L 57,9** 08902401C  
1 central structure H 36 W 57,9
- **2 mensole in melaminico P 31 L 55,8** 08902385  
2 melamine shelves D 31 W 55,8
- **1 mensola in melaminico P 31 L 85,8** 08902388  
1 melamine shelf D 31 W 85,8
- **2 mensole in alluminio P 31 L 55,8** 08902375  
2 aluminium shelves D 31 W 55,8
- **1 mensola in alluminio P 31 L 85,8** 08902378  
1 aluminium shelf D 31 W 85,8
- **Kit alimentatore 100 Watt (mercato UE)** 08902351  
Power suppli kit 100 Watt (UE Market)
- **Maggiorazione kit luce led Dual Color** opz.002  
Surcharge led light kit Dual Color

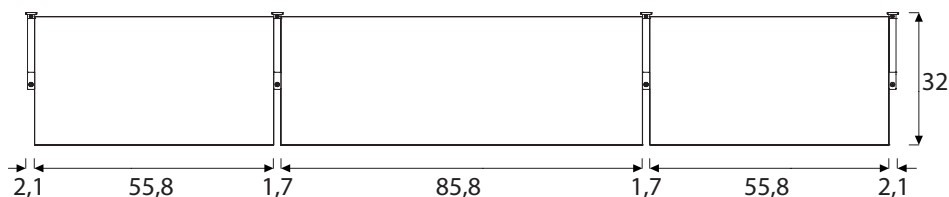

### ESEMPIO “MULTIPLO SOSPESO H 108 L 117,5”

EXAMPLE “MULTIPLO HANGING H 108 W 117,5”

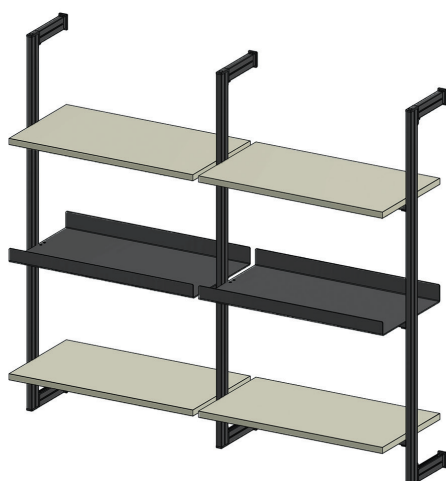

- **1 struttura singola H 108 L 60** 08902405  
1 single structure H 108 W 60
- **1 struttura centrale H 108 L 57,9** 08902405C  
1 central structure H 108 W 57,9
- **4 mensole in melaminico P 31 L 55,8** 08902385  
4 melamine shelves D 31 W 55,8
- **2 mensole in alluminio P 31 L 55,8** 08902375  
2 aluminium shelves D 31 W 55,8
- **Kit alimentatore 30 Watt (mercato UE)** 08902350  
Power suppli kit 30 Watt (UE Market)
- **Maggiorazione kit luce led Dual Color** opz.002  
Surcharge led light kit Dual Color

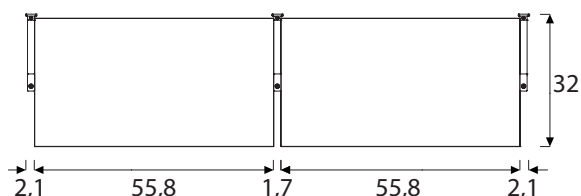

## “MULTIPLO” ESEMPI DI COMPONENTABILITÀ

“MULTIPLO” EXAMPLES OF MODULARITY

### ESEMPIO “MULTIPLO LIBRERIA A PARETE H 217 L 235”

EXAMPLE “MULTIPLO WALL BOOKCASE H 217 W 235”

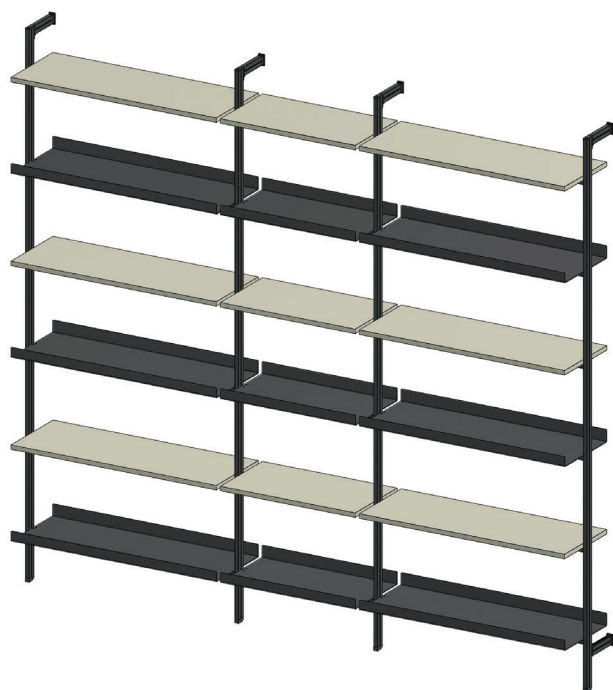

- **1 struttura singola H 217 L 90** 08902423  
1 single structure H 217 W 90
- **1 struttura centrale H 217 L 57,9** 08902421C  
1 central structure H 217 W 57,9
- **1 struttura centrale H 217 L 87,9** 08902423C  
1 central structure H 217 W 87,9
- **6 mensole in melaminico P 31 L 85,8** 08902388  
6 melamine shelves D 31 W 85,8
- **3 mensole in melaminico P 31 L 55,8** 08902385  
3 melamine shelves D 31 W 55,8
- **6 mensole in alluminio P 31 L 85,8** 08902378  
6 aluminium shelves D 31 W 85,8
- **3 mensole in alluminio P 31 L 55,8** 08902375  
3 aluminium shelves D 31 W 55,8
- **Kit alimentatore 100 Watt (mercato UE)** 08902351  
Power supply kit 100 Watt (UE Market)
- **Maggiorazione kit luce led Dual Color** opz.002  
Surcharge led light kit Dual Color

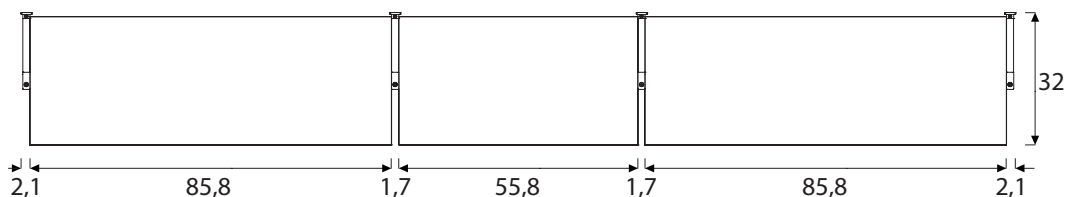

### ESEMPIO “MULTIPLO TERMINALE H 180 L 49,2” per colonna H 204

EXAMPLE “MULTIPLO END UNIT H 180 W 49,2” for column H 204

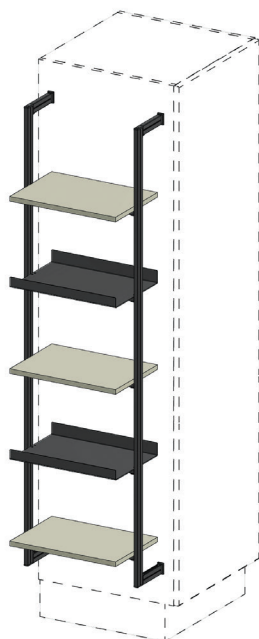

- **1 struttura terminale H 180 L 45** 08902265  
1 end structure H 180 W 45
- **3 mensole laccate P 31 L 45** 08902394  
3 lacquered shelves D 31 W 45
- **2 mensole in alluminio P 31 L 45** 08902374  
2 aluminium shelves D 31 W 45

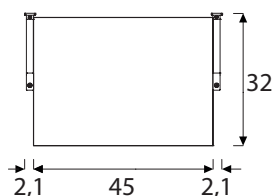

## “MULTIPLO” ESEMPI DI COMPONENTABILITÀ

“MULTIPLO” EXAMPLES OF MODULARITY

### ESEMPIO “MULTIPLO SOSPESO H 108 L 117,5”

EXAMPLE “MULTIPLO HANGING H 108 W 117,5”

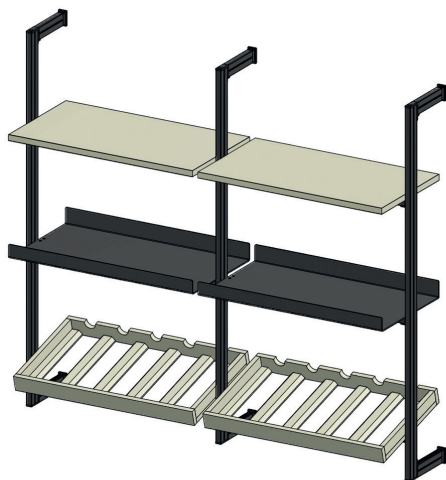

- 1 struttura singola H 108 L 60 08902405  
1 single structure H 108 W 60
- 1 struttura centrale H 108 L 57,9 08902405C  
1 central structure H 108 W 57,9
- 2 mensole in melaminico P 31 L 55,8 08902385  
2 melamine shelves D 31 W 55,8
- 2 mensole in alluminio P 31 L 55,8 08902375  
2 aluminium shelves D 31 W 55,8
- 2 portabottiglie in legno P 31 L 55,8 08902295  
2 wood bottles rack D 31 W 55,8
- Kit alimentatore 30 Watt (mercato UE) 08902350  
Power suppli kit 30 Watt (UE Market)
- **Maggiorazione kit luce led Dual Color** opz.002  
**Surcharge led light kit Dual Color**

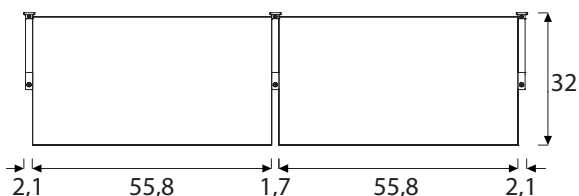

### ESEMPIO “MULTIPLO LIBRERIA A PARETE H 217 L 235”

EXAMPLE “MULTIPLO WALL BOOKCASE H 217 W 235”

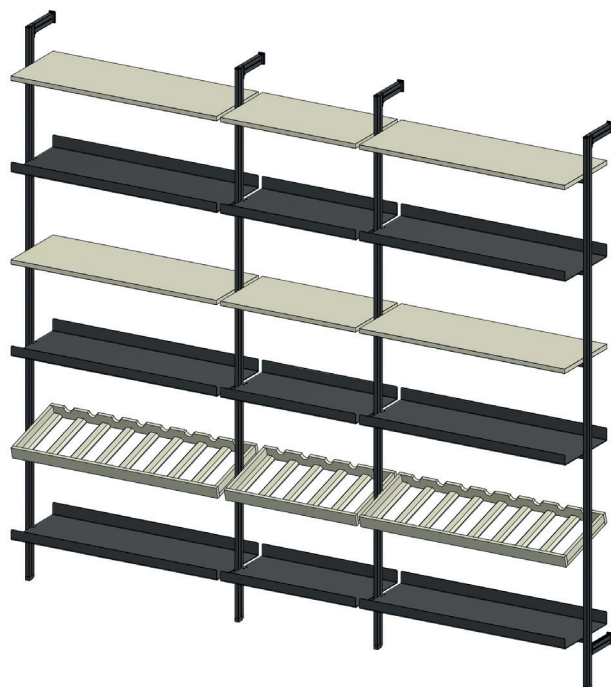

- 1 struttura singola H 217 L 90 08902423  
1 single structure H 217 W 90
- 1 struttura centrale H 217 L 57,9 08902421C  
1 central structure H 217 W 57,9
- 1 struttura centrale H 217 L 87,9 08902423C  
1 central structure H 217 W 87,9
- 4 mensole in melaminico P 31 L 85,8 08902388  
4 melamine shelves D 31 W 85,8
- 2 mensole in melaminico P 31 L 55,8 08902385  
2 melamine shelves D 31 W 55,8
- 6 mensole in alluminio P 31 L 85,8 08902378  
6 aluminium shelves D 31 W 85,8
- 3 mensole in alluminio P 31 L 55,8 08902375  
3 aluminium shelves D 31 W 55,8
- 2 portabottiglie in legno P 31 L 85,8 08902298  
2 wood bottles rack D 31 W 85,8
- 1 portabottiglie in legno P 31 L 55,8 08902295  
1 wood bottles rack D 31 W 55,8
- Kit alimentatore 100 Watt (mercato UE) 08902351  
Power suppli kit 100 Watt (UE Market)
- **Maggiorazione kit luce led Dual Color** opz.002  
**Surcharge led light kit Dual Color**

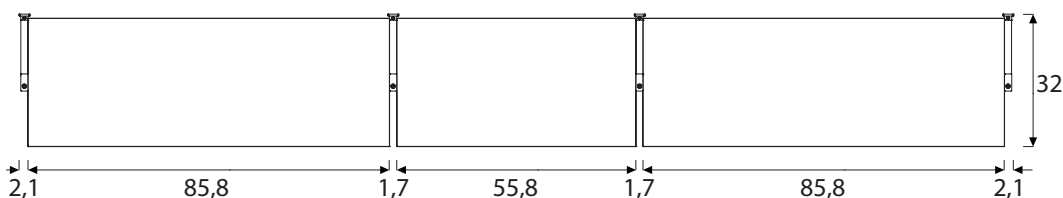

# Sign

COLLEZIONE 2021

2021 COLLECTION

LUCE FUNZIONALE  
CHE ARREDA

FUNCTIONAL LIGHT  
THAT FURNISHES

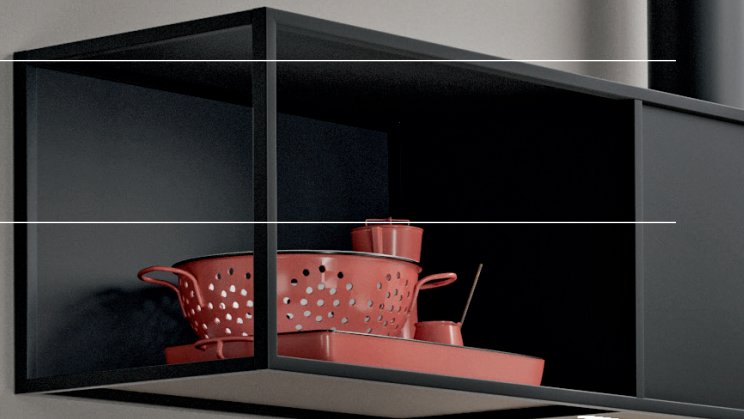

CUCINE  
**LUBE**

GRUPPOLUBE

**CREO**  
KITCHENS

Il profilo a parete può alloggiare cavi di diverse dimensioni, fungendo da canalina passacavo e contribuendo ad organizzare gli elementi in modo ordinato. Gli angoli interni ed esterni a 90° consentono di seguire i volumi architettonici, creando un effetto continuo di luce e arredo nei diversi ambienti domestici. Il grado di protezione IP44 ne consente l'installazione in ambienti soggetti a umidità, schizzi d'acqua e che necessitano di frequenti pulizie come il bagno e la cucina. L'accensione e dimmerazione della luce sono disponibili, su richiesta, con l'integrazione del sensore IR o tramite controlli remoti grazie al nostro sistema di alimentazione Mec Driver.

The wall profile can accommodate cables of various sizes, acting as a cable duct and helping to organise the elements in an orderly manner.

The 90° internal and external angles enable architectural volumes to be followed, creating a continuous effect of light and decoration in the different rooms of the home.

The IP44 degree of protection enables it to be installed in environments subject to humidity, splashing water and frequent cleaning, such as bathrooms and kitchens.

Switching and dimming of the light is available on request with the integration of the IR sensor or via remote controls thanks to our supply system Mec Driver.





Sign integra una coppia di lampade lineari, per un effetto omogeneo a doppia emissione che conferisce un'atmosfera immersiva all'ambiente domestico. Il profilo superiore ha un effetto di luce di cortesia wallwasher mentre il profilo inferiore garantisce una corretta illuminazione con un'emissione funzionale, prevenendo la necessità di installare ulteriori fonti luminose per illuminare il piano di lavoro.

Sign integrates a pair of linear lamps for a homogeneous dual-emission effect that lends an immersive atmosphere to the home environment. The upper profile has a wallwasher courtesy light effect, whilst the lower profile ensures proper lighting with a functional output, preventing the need to install additional light sources to illuminate the worktop.



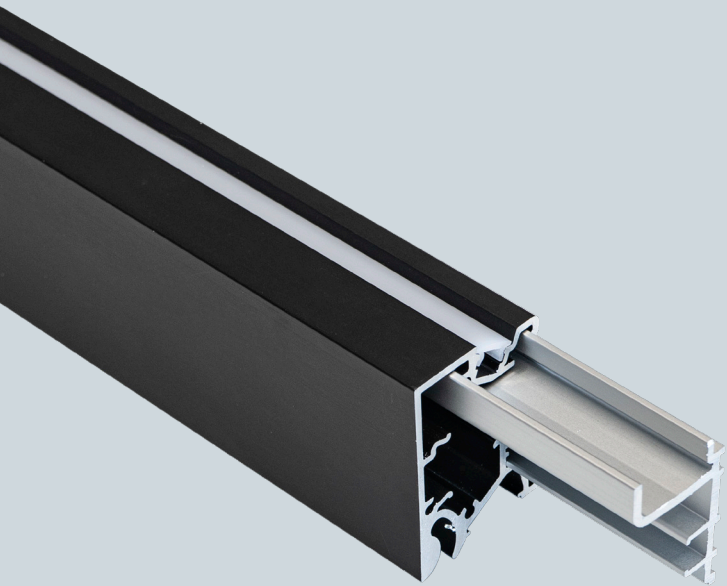

## Staffa

La staffa di fissaggio in alluminio viene fissata a parete tramite viti e tasselli.

## Bracket

The aluminium fixing bracket is fixed to the wall using screws and dowels.

## Cover

Il profilo di copertura, in alluminio anodizzato nero, viene fissato a incastro sulla staffa.

Il vano interno funge da canalina passacavo, contribuendo ad organizzare cavi ed elementi di elettrificazione di Sign e degli altri complementi.

## Cover

The cover profile, made of black anodised aluminium, is snapped onto the bracket. The internal compartment acts as a cable duct, helping to organise cables and electrification elements for Sign and other accessories.



## Protezione

L'indice di protezione IP44 consente l'applicazione di Sign anche in ambienti soggetti a umidità o che necessitano di pulizie frequenti.

## Protection

The IP44 protection rating means that Sign can also be used in environments that are subject to moisture or require frequent cleaning.

IP44

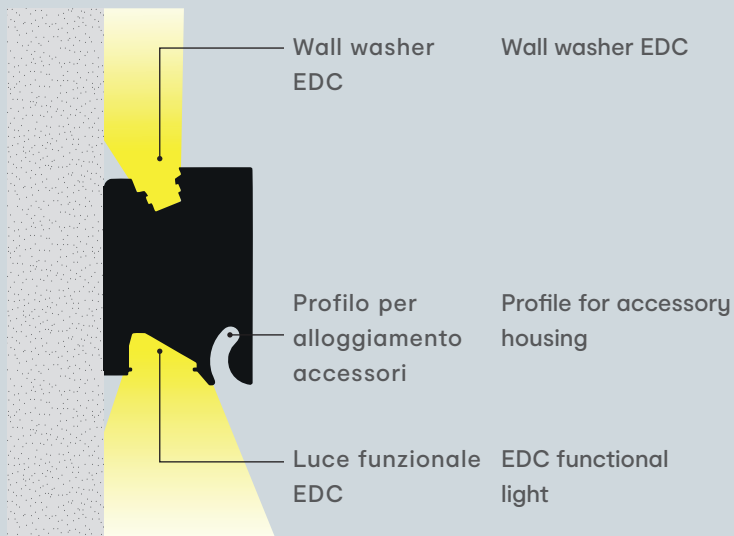

**SIMULAZIONE VISTA  
LATERALE SENZA TESTATE  
SIMULATION OF SIDE VIEW WITHOUT  
HEADERS**

## Ottiche dedicate

Le sorgenti luminose sono dotate di ottiche studiate appositamente per creare un effetto wall washer verso l'alto e per illuminare in modo omogeneo e confortevole il piano di lavoro.

## Dedicated optics

The light sources are equipped with specially designed optics to create an upward wall washer effect and to illuminate the work surface evenly and comfortably.



Su misura: 200 mm ~ 3000 mm Tailor-made: 200 mm ~ 3000 mm

# Sign

## Elementi componibili

### Modular elements

L'ampia serie di accessori proposti, i moduli a giorno componibili, le mensole e i porta oggetti, rendono Sign adatto ad ogni ambiente domestico, dalla cucina al bagno, dalla zona living all'home office e alla zona notte.

The wide range of accessories offered, the modular open modules, the shelves and the storage units, make Sign suitable for any domestic environment, from the kitchen to the bathroom, from the living area to the home office and the sleeping area.

**N.B.:** Per dettagli montaggio vedi note specifiche a pag.16

**Note:** For assembly details see specific notes on page 16



Disegnato da:  
Designed by:  
**Michele Marcon Designer**

# Sign



Su richiesta, il profilo è disponibile tagliato a misura.  
Per un utilizzo come luce decorativa e di cortesia si consiglia di scegliere la combinazione di sorgente superiore e inferiore 120 + 120 LEDs/m, per un utilizzo funzionale, ad esempio in cucina, ufficio o in presenza di piani di lavoro, si consiglia la composizione sorgente superiore 120 + 120 LEDs/m e inferiore 240 + 240 LEDs/m.

On request, the profile is available cut to size and with corner joints.

For use as a decorative and courtesy light we recommend the top and bottom combination 120 + 120 LEDs/m, for functional use, e.g., in kitchens, offices or on worktops, we recommend the top combination 120 + 120 LEDs/m and the bottom combination 240 + 240 LEDs/m.

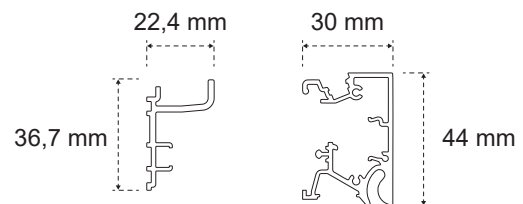

## SIGN EDC 24 V DC

120+240 LEDs/m

 086SI120	36,7 W	1200 mm	3000-4000K
 086SI150	46,2 W	1500 mm	3000-4000K
 086SI180	55,6 W	1800 mm	3000-4000K
 086SI240	74,5 W	2400 mm	3000-4000K
 086SI300	93,6 W	3000 mm	3000-4000K
 086SI370	121,7 W	3700 mm	3000-4000K

## SIGN AL ML (DA UTILIZZARE PER MISURE NON STANDARD) (TO BE USED FOR NON-STANDARD MEASUREMENTS)

 086SI000	32 W-ml	min.20cm max.370cm	3000-4000K
---	---------	-----------------------	------------

maggiorazione fissa per taglio fuori misura  
fixed surcharge for oversize cut

N.B.: Per dettagli montaggio vedi note specifiche a pag.16

Note: For assembly details see specific notes on page 16

## ACCESSORI E CONTROLLO ACCESSORIES AND CONTROL



### EMOTION JUMPER

Il cavo incluso permette la variazione della temperatura colore da bianco 'caldo' a 'naturale' (3000-4000K).

### EMOTION JUMPER

The included cable allows for colour temperature variation from 'warm' to 'natural' white (3000-4000K).



### SMART 1 CONTROLLER

Per la scelta del sistema di controllo andare a pagina 18

### SMART 1 CONTROLLER

For the choice of control system go to page 18



### MEC DRIVER

Per la scelta del sistema di alimentazione andare a pagina 18

### MEC DRIVER

For the selection of the power supply system go to page 18

## Moduli orizzontali

### Horizontal modules



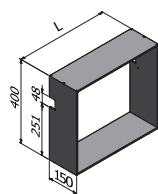

Moduli a giorno in alluminio spazzolato antigraffio di colore nero, installabili ad incastro sul profilo Sign.

Open modules made of black scratch-resistant brushed aluminium, which can be clicked onto the Sign profile.



#### MODULI ORIZZONTALI 1 VANO

	086SI401	300 x 400 x 150 mm
	086SI402	450 x 400 x 150 mm
	086SI403	600 x 400 x 150 mm

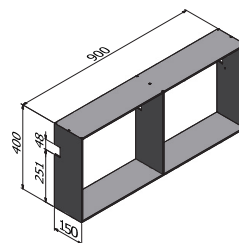

#### MODULI ORIZZONTALI 2 VANI

	086SI404	900 x 400 x 150 mm
---	----------	--------------------

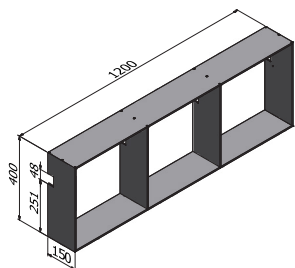

#### MODULI ORIZZONTALI 3 VANI

	086SI405	1200 x 400 x 150 mm
---	----------	---------------------

## Moduli verticali

### Vertical modules





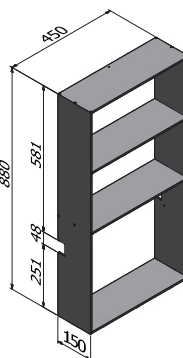
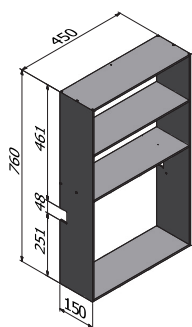

Moduli a giorno in alluminio spazzolato antigraffio di colore nero, installabili ad incastro sul profilo Sign.





Open modules made of black scratch-resistant brushed aluminium, which can be clicked onto the Sign profile.



#### MODULI VERTICALI SUPERIORI 3 VANI



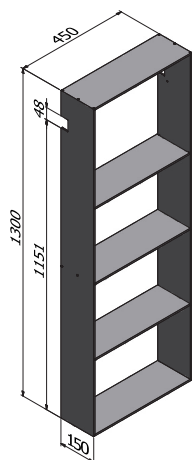

 086SI411	300 x 760 x 150 mm
 086SI412	450 x 760 x 150 mm
 086SI413	600 x 760 x 150 mm
 086SI414	900 x 760 x 150 mm

#### MODULI VERTICALI SUPERIORI 3 VANI

 086SI421	300 x 880 x 150 mm
 086SI422	450 x 880 x 150 mm
 086SI423	600 x 880 x 150 mm
 086SI424	900 x 880 x 150 mm



#### MODULI VERTICALI INFERIORI 4 VANI

 086SI431	300 x 1300 x 150 mm
 086SI432	450 x 1300 x 150 mm
 086SI433	600 x 1300 x 150 mm
 086SI434	900 x 1300 x 150 mm

# Accessori

## Accessories

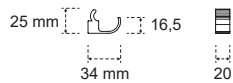

### SET 4 GANCI

 086SI460

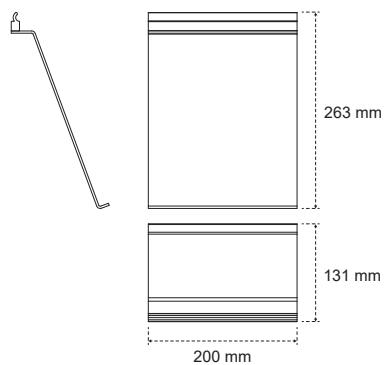

### PORTA TABLET

 086SI461

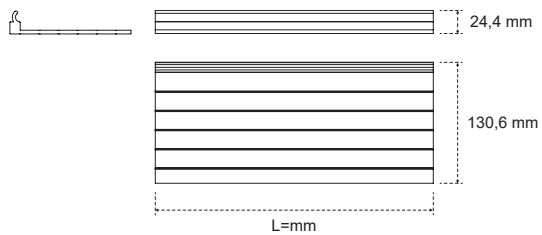

### MENSOLE SIGN

 086SI450 286 mm

 086SI451 390 mm

 086SI452 436 mm

 086SI453 586 mm

 086SI454 886 mm

Le mensole sono integrabili all'interno dei moduli a giorno.  
The shelves can be integrated into the open modules.



# Accessori cucina

## Kitchen accessories

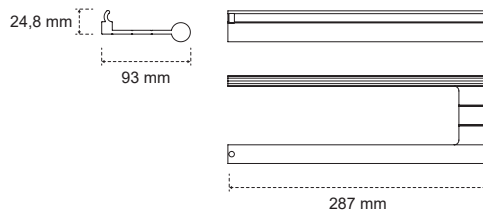

### PORTA ROTOLO CARTA CUCINA

<sup>03</sup> 086SI462

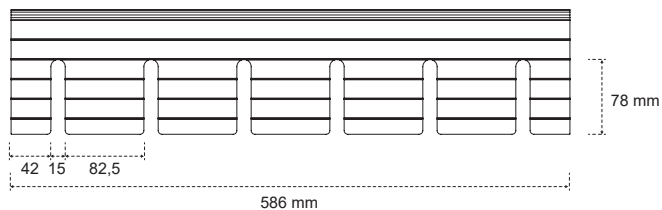
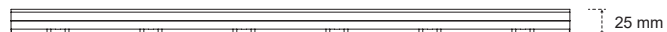
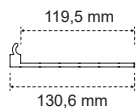
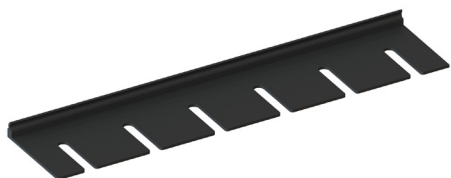

### PORTA CALICI

<sup>03</sup> 086SI463



### PRESA CORRENTE (2 SCHUKO)

<sup>03</sup> 086SI464

N.B.: è consigliata per nascondere il cavo di alimentazione  
 Note: is recommended for hiding the power cable

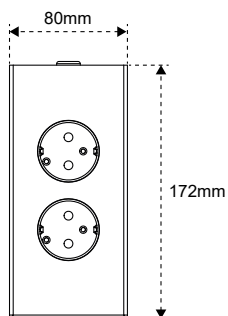

# MEC DRIVER

## 4 ALIMENTATORI IN 1, CON SISTEMI DI COMANDO INTEGRATI

Più flessibilità per connettere il futuro

## 4 POWER SOURCES IN 1, WITH INTEGRATED CONTROL SYSTEMS

Increased flexibility to connect the future

### IL "DO IT YOURSELF" DI NUOVA GENERAZIONE

#### MEC DRIVER RIVOLUZIONA IL MONDO DELL'ILLUMINAZIONE LED

Da oggi è possibile costruire in completa autonomia e con la massima semplicità un sistema di alimentazione modulare che gestisca illuminazione e domotica, già pronto e certificato per quasi tutti i mercati mondiali. Il cuore del sistema è il nuovo alimentatore multitemperatura disponibile in 6 diverse potenze (18, 36, 48, 72, 90, 120W) e componibile con tutte le principali prese. Ad esso si possono connettere i moduli per comandare a distanza ogni funzione di regolazione dell'illuminazione, del suono e della domotica. In tal modo si ottiene una soluzione di controllo completa, dall'ingombro minimo.

### NEXT GENERATION DIY

#### PROMISES TO TRANSFORM THE WORLD OF LED LIGHTING

Now you can build your own lighting and home modular automation power supply system – which has been approved for almost any global market – with incredible speed and ease of assembly. The heart of the system is the new multi-voltage power source, available in six different levels of wattage (18, 36, 48, 72, 90 and 120W) and suitable for all common socket-types. It is possible to connect the modules for remote regulation of every aspect of home lighting, sound and automation. In this way you can reach a compact and modular solution, for a complete control of all system.



#### MULTITEMPERATURA

Input: 100\240VAC Output: 24 VDC

#### MULTI-VOLTAGE

Input: 100\240VAC Output: 24 VDC



#### CERTIFICAZIONI INTERNAZIONALI

ALL LEADING INTERNATIONAL ACCREDITATIONS



#### CONTROLLO REMOTO

Via Wi-fi, Radio Frequenza (R.F.), Bluetooth, sensori via cavo

#### REMOTE CONTROL

Connection via Wi-fi, Radio Frequency (R.F.), Bluetooth, wired sensors

## ONE DRIVER ENDLESS OPTIONS

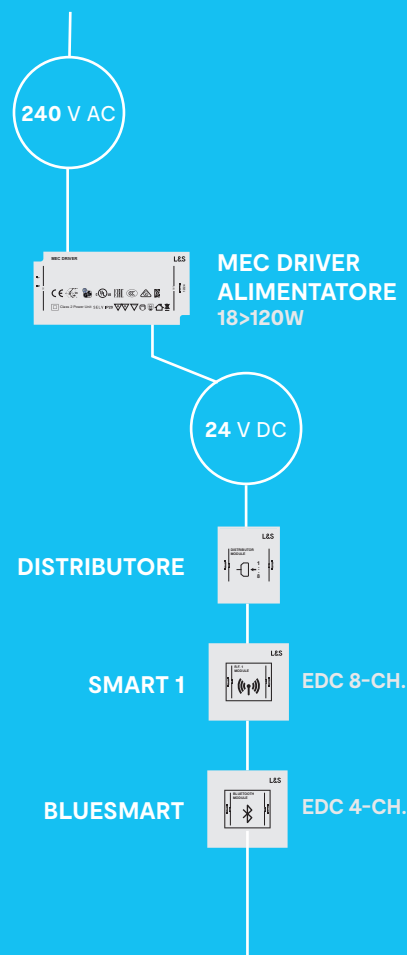

# KIT BASE

# Alimentazione basilare/Connessione diretta Basic power supply/Direct connection

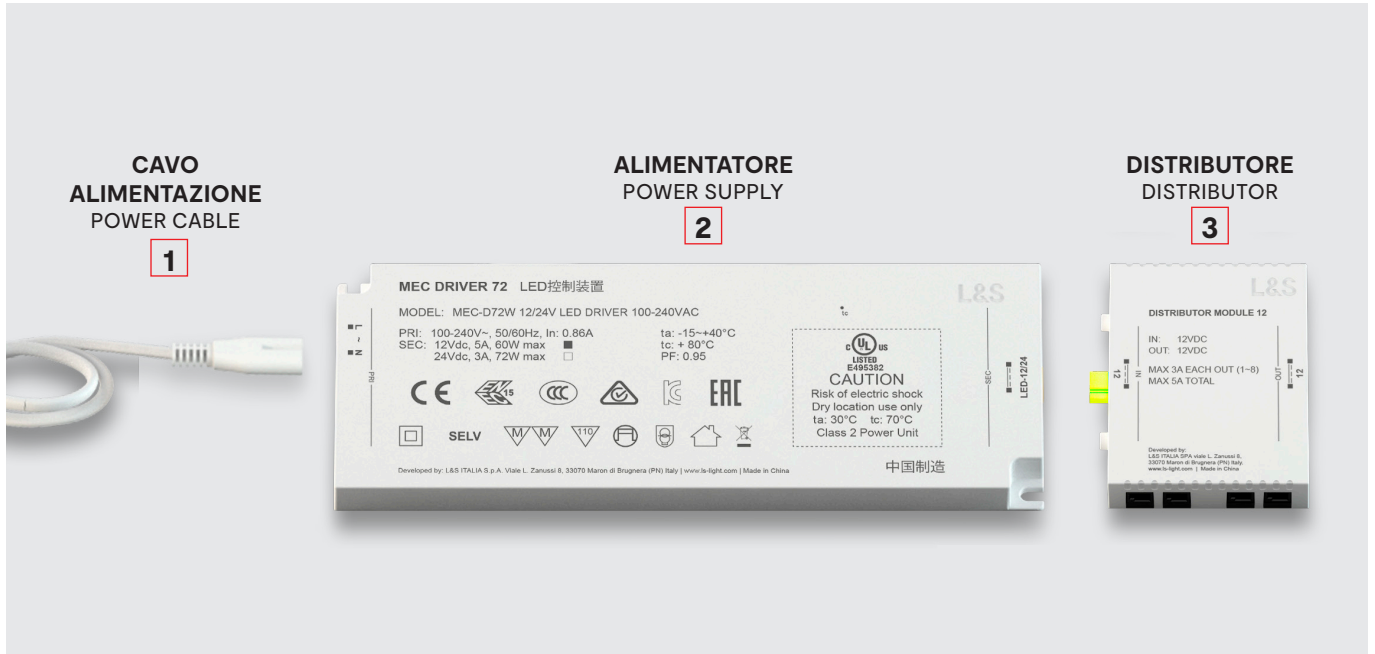

### Composto da:

- 1) CAVO ALIMENTAZIONE (EU/USA/Canada)
- 2) ALIMENTATORE **in base alla potenza necessaria**
- 3) DISTRIBUTORE

### Composed of:

- 1) POWER CABLE (EU/USA/Canada)
- 2) POWER SUPPLY **according to the power request**
- 3) DISTRIBUTOR

## KIT ALIMENTAZIONE EUROPA EUROPE POWER SUPPLY KIT

KIT EUROPA	POWER	OUTPUT	codice code
12422150000	18 W	24 V DC	08618000EU
12422160000	36 W	24 V DC	08618001EU
12422170000	48 W	24 V DC	08618002EU
12422180000	72 W	24 V DC	08618003EU
12422190000	90 W	24 V DC	08618004EU
12425890000	120 W	24 V DC	08618005EU

## KIT ALIMENTAZIONE USA/CANADA USA/CANADA POWER SUPPLY KIT

KIT USA/CANADA	POWER	OUTPUT	codice code
12422070000	18 W	24 V DC	08618000UL
12422080000	36 W	24 V DC	08618001UL
12422080000	48 W	24 V DC	08618002UL
12422100000	60 W	24 V DC	08618003UL
12422580000	90 W	24 V DC	08618004UL

# Accensione con telecomando

## Switch on with remote control (1 area)

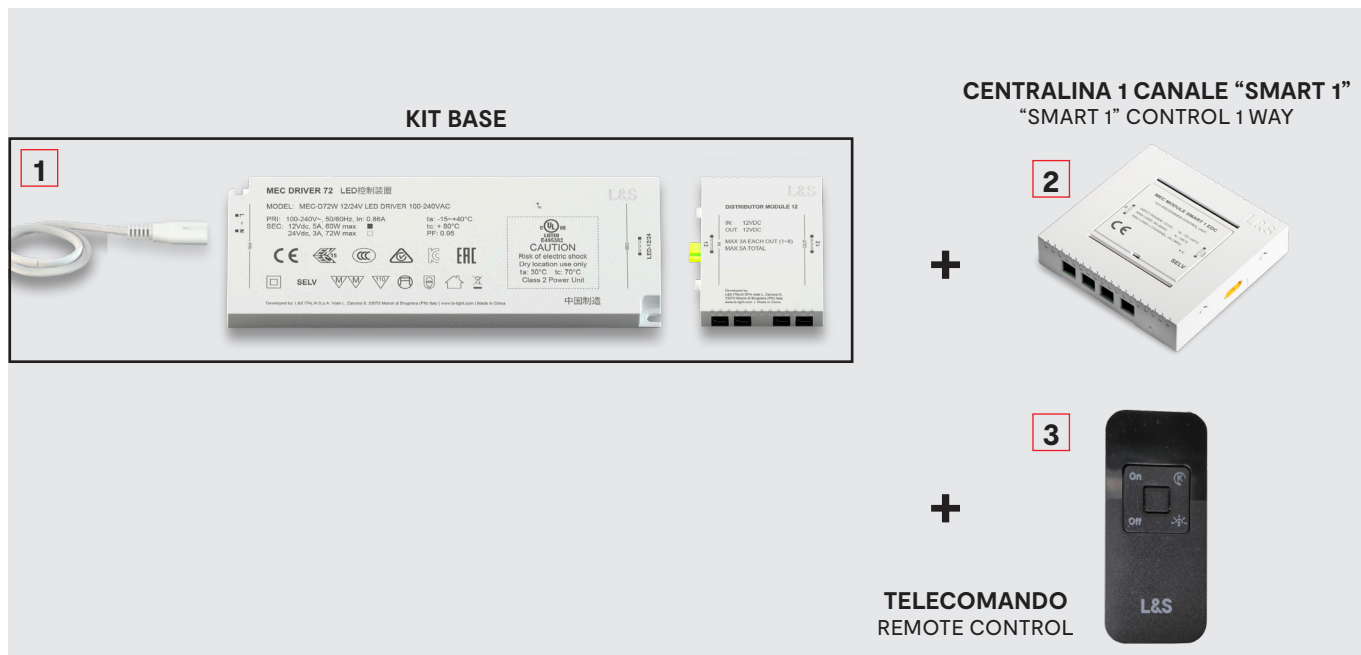

### Composto da:

- 1) KIT BASE (EUROPA o USA/Canada)
- 2) CENTRALINA 1 CANALE "SMART 1"
- 3) TELECOMANDO (da scegliere)

### Composed of:

- 1) BASIC KIT (EUROPE or USA/Canada)
- 2) "SMART 1" CONTROL 1 WAY
- 3) REMOTE CONTROL (to be selected)

## 2 CENTRALINA 1 CANALE "SMART 1" "SMART 1" CONTROL 1 WAY



OUTPUT: Max 5 A total, max 3 A/output

SMART 1	TIPO	INPUT	WAYS	codice code
24201880100	EDC	24 V DC	8	08618031

La centralina *Smart 1* consente di controllare simultaneamente fino a 8 lampade in uscita con i telecomandi della linea *Smart Up 1* e *Smart Up 4*. I moduli possono essere connessi ad altri moduli di distribuzione o di controllo purché si mantenga la stessa tensione in uscita.

The *Smart 1* control unit allows you to simultaneously control up to 8 output lamps with the *Smart Up 1* and *Smart Up 4* remote controls. The modules can be connected to other distribution or control modules as long as the same output voltage is maintained.

## 3 TELECOMANDO 1 CANALE REMOTE CONTROL 1 WAY



### SMART UP 1

- \ On/Off - Dimmerazione - Gestione del colore
- \ 15 m portata all'interno di edifici
- \ Batteria CR2032 (3 anni di durata)
- \ On/Off - Dimming - Colour management
- \ 15 m range indoor
- \ Battery CR2032 (3 years lasting)

SMART UP 1 (1 CANALE)	TIPO	DIMENSIONI	codice code
 24203240300	EDC	82x37x10	08618034

## TELECOMANDO 4 CANALI REMOTE CONTROL 4 WAYS



### SMART UP 4

- \ On/Off - Dimmerazione - Gestione del colore
- \ 15 m portata all'interno di edifici
- \ Batteria CR2032 (3 anni di durata)
- \ On/Off - Dimming - Colour management
- \ 15 m range indoor
- \ Battery CR2032 (3 years lasting)

SMART UP 4 (4 CANALI)	TIPO	DIMENSIONI	codice code
 24203250300	EDC	82x37x10	08618035

# Accensione con app "BlueSmart" o telecomando (4 zone) Switch on with "BlueSmart" app or remote control (4 areas)

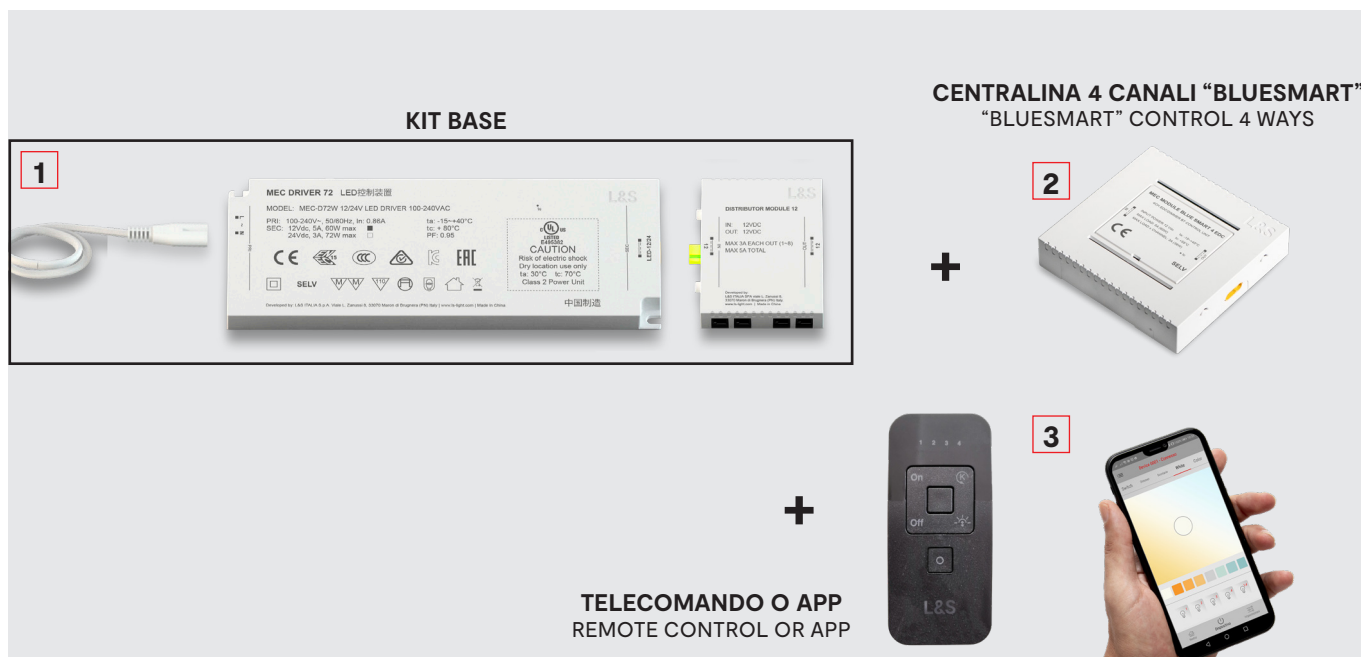

## Composto da:

- 1) KIT BASE (EUROPA o USA/Canada)
- 2) CENTRALINA 4 CANALI "BLUESMART 4" (Bluetooth)
- 3) TELECOMANDO 4 CANALI "SMART UP 4" o App "BlueSmart"

## Composed of:

- 1) BASIC KIT (EUROPE or USA/Canada)
- 2) "BLUESMART" CONTROL 4 WAYS (Bluetooth)
- 3) REMOTE CONTROL 4 WAYS "SMART UP 4" or "BlueSmart" App

## 2 CENTRALINA 4 CANALI "BLUESMART" "BLUESMART" CONTROL 4 WAYS



OUTPUT: Max 5 A total, max 3 A/output

BLUESMART	TIPO	INPUT	WAYS	codice code
24201770100	EDC	24 V DC	4	08618030

La centralina *BlueSmart* consente di controllare individualmente fino a 4 lampade in uscita tramite l'apposita app, scaricabile gratuitamente da *App Store* e *Google Play*. È inoltre compatibile con i telecomandi della linea *Smart Up 1* e *Smart Up 4*. I moduli possono essere connessi ad altri moduli di distribuzione o di controllo purché si mantenga la stessa tensione in uscita.

The *BlueSmart* control unit allows you to individually control up to 4 output lamps using the *Bluesmart* app, which can be downloaded for free from the *App Store* and *Google Play*. It is also compatible with the *Smart Up 1* and *Smart Up 4* remote controls. The modules can be connected to other distribution or control modules as long as the same output voltage is maintained.

## 3 TELECOMANDO 4 CANALI REMOTE CONTROL 4 WAYS



### SMART UP 4

- On/Off - Dimmerazione - Gestione del colore
- 15 m portata all'interno di edifici
- Batteria CR2032 (3 anni di durata)
- On/Off - Dimming - Colour management
- 15 m range indoor
- Battery CR2032 (3 years lasting)

SMART UP 4 (4 CANALI)	TIPO	DIMENSIONI	codice code
03 24203250300	EDC	82x37x10	08618035

## APP "BLUESMART" "BLUESMART" APP



Vedi spiegazioni a pagina 37.  
See explanations on page 37.



ANDROID APP ON  
Google Play



Download on the  
App Store

## MOLTIPLICATORE INGRESSI INPUT MULTIPLIER



Modalità di utilizzo  
Use modality

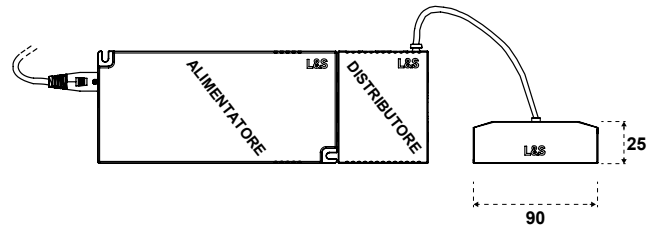

INPUT: 24 V DC

MOLTIPLICATORE	WAYS	CAVO	codice code
12606760000	10	200 mm	08618026

Il moltiplicatore di ingressi consente di collegare fino a 10 lampade per ogni ingresso del modulo. Può essere inserito su tutti i KIT.

The input multiplier allows up to 10 lamps to be connected to each input of the module. It can be inserted on all KIT.

## PROLUNGA EXTENSION



INPUT: 24 V DC

PROLUNGA	CAVO	codice code
	2000 mm	08618029

Prolunga universale per tutti i prodotti. Da utilizzare in aggiunta ai cavi standard per distanze maggiori tra alimentatore e elemento luminoso.

Universal extension cable for all products. To be used in addition to standard cables for longer distances between ballast and lighting element.

## CENTRALINA 1 CANALE “SMART 1” “SMART 1” CONTROL 1 WAY

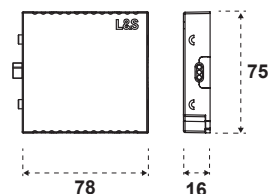

**OUTPUT:** Max 5 A total, max 3 A/output

SMART 1	TIPO	INPUT	WAYS	codice code
24201880100	EDC	24 V DC	8	08618031

La centralina *Smart 1* consente di controllare simultaneamente fino a 8 lampade in uscita con i telecomandi della linea *Smart Up 1* e *Smart Up 4*. I moduli possono essere connessi ad altri moduli di distribuzione o di controllo purché si mantenga la stessa tensione in uscita.

The Smart 1 control unit allows you to simultaneously control up to 8 output lamps with the Smart Up 1 and Smart Up 4 remote controls. The modules can be connected to other distribution or control modules as long as the same output voltage is maintained.

## CENTRALINA 4 CANALI “BLUESMART” “BLUESMART” CONTROL 4 WAYS

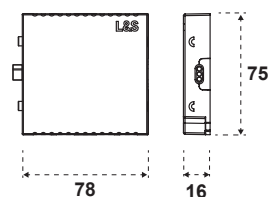

**OUTPUT:** Max 5 A total, max 3 A/output

BLUESMART	TIPO	INPUT	WAYS	codice code
24201770100	EDC	24 V DC	4	08618030

La centralina *BlueSmart* consente di controllare individualmente fino a 4 lampade in uscita tramite l'apposita app, scaricabile gratuitamente da *App Store* e *Google Play*. È inoltre compatibile con i telecomandi della linea *Smart Up 1* e *Smart Up 4*. I moduli possono essere connessi ad altri moduli di distribuzione o di controllo purché si mantenga la stessa tensione in uscita.

The BlueSmart control unit allows you to individually control up to 4 output lamps using the Bluesmart app, which can be downloaded for free from the App Store and Google Play. It is also compatible with the Smart Up 1 and Smart Up 4 remote controls. The modules can be connected to other distribution or control modules as long as the same output voltage is maintained.

## TELECOMANDO 1 CANALE "SMART UP 1"

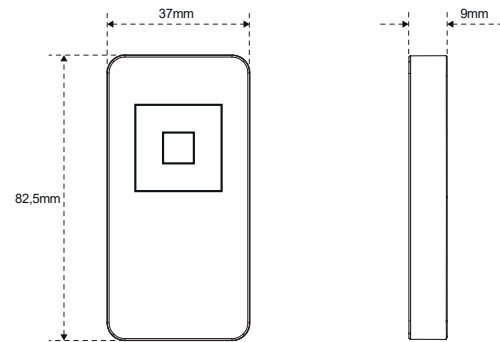

TELECOMANDO SMART UP 1	TIPO
 24203240300	EDC

codice  
code

08618034

Telecomando wireless.

Associato alla centralina Smart 1 o Smart 4, controlla le luci sia per funzioni di dimmerizzazione dell'intensità luminosa, che di cambio della temperatura colore.

- \ On/Off - Dimmerazione - Gestione del colore
- \ 15 m portata all'interno di edifici
- \ Batteria CR2032 (3 anni di durata)
- \ On/Off - Dimming - Colour management
- \ 15 m range indoor
- \ Battery CR2032 (3 years lasting)

Wireless controller.

Associated with the Smart 1 or Smart 4 control, it controls de lights both for dimming the light intensity and for changing the colour temperature.

## TELECOMANDO 4 CANALI "SMART UP 4"

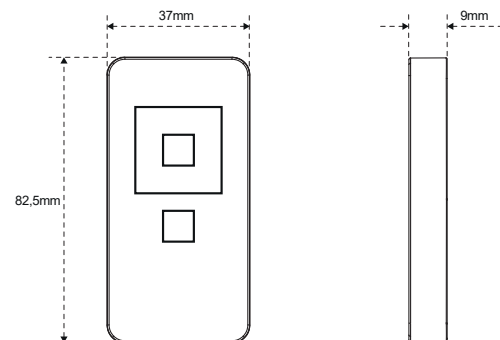

TELECOMANDO SMART UP 4	TIPO	WAYS
 24203250300	EDC	4 ch.

codice  
code

08618035

Telecomando wireless con possibilità di controllare e memorizzare fino a 4 canali indipendenti.

Associato alla centralina Smart 4, controlla le luci sia per funzioni di dimmerazione dell'intensità luminosa, che di cambio della temperatura colore nella versione EDC.

- \ On/Off - Dimmerazione - Gestione del colore
- \ 15 m portata all'interno di edifici
- \ Batteria CR2032 (3 anni di durata)
- \ On/Off - Dimming - Colour management
- \ 15 m range indoor
- \ Battery CR2032 (3 years lasting)

Wireless controller with central button, crown and touch controls, with the possibility to control and store up to 4 independent channels. Combined with the Smart 4 control, it controls the lights both for dimming the light intensity and changing the colour temperature in the EDC version.





### DEVICE SETTING

Consente di visualizzare i dispositivi connessi suddivisi in zone.

Displays the connected devices divided into zones.

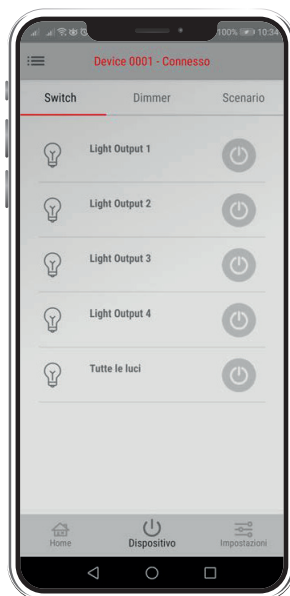

### SWITCH MODE

Consente di selezionare, accendere o spegnere le singole zone.

Allows you to select, switch on or off individual zones.

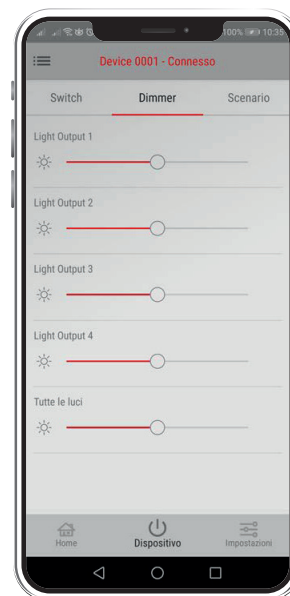

### DIMMER MODE

Consente di regolare l'intensità luminosa di ogni singola lampada.

Allows you to adjust the light intensity of each individual lamp.



### SCENARIO MODE

Consente di gestire fino a 4 diversi scenari da configurare con le impostazioni preferite.

It allows you to manage up to 4 different scenarios to configure with your preferred settings.



### WHITE MODE

Nelle versioni EDC, consente di selezionare la temperatura di colore di ogni singola lampada.

In the EDC versions, it allows you to select the color temperature of each individual lamp.



ANDROID APP ON  
Google Play



Download on the  
App Store

# Schemi Montaggio

## Assembly diagrams

In fase di montaggio si può scegliere il lato di fuoriuscita dei connettori led.  
 Per evitare che gli stessi rimangano a vista consigliamo l'utilizzo di uno schienale o di veicolarene l'uscita in prossimità di un fianco a battuta. (Vedi schemi riportati a seguire)

During the assembly phase, you can choose the side of the LED connectors.  
 To prevent them from remaining visible, we recommend the use of a backrest or to convey the exit in the vicinity of a stop flank. (See diagrams below)

### ESEMPI DI APPLICAZIONE LATO FIANCO A BATTUTA EXAMPLES OF APPLICATION ON THE SIDE-TO-STOP SIDE

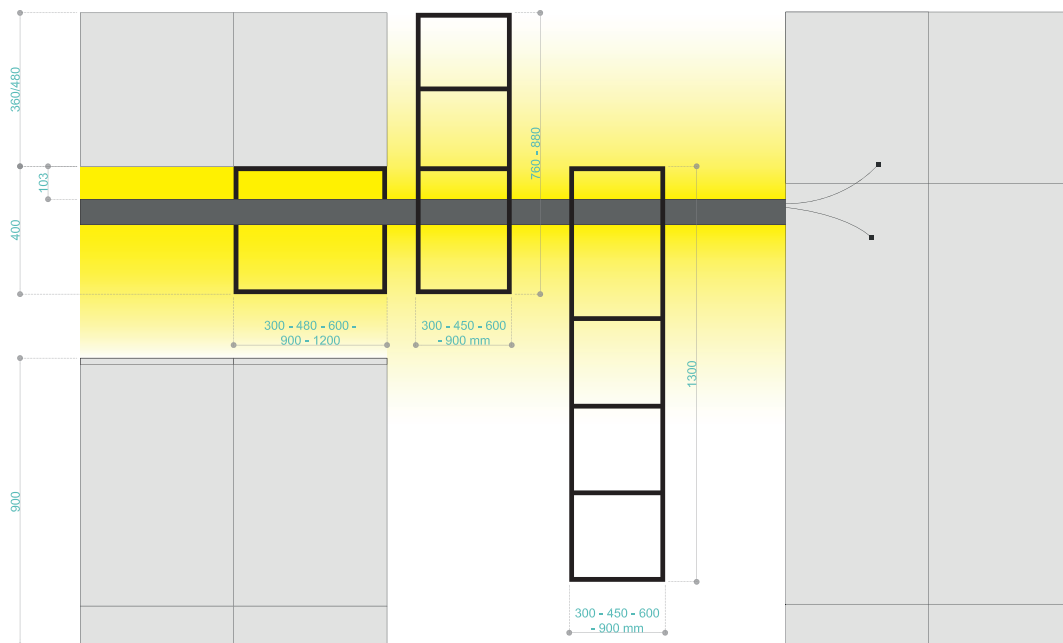

Esempio di applicazione in cucina  
 Example of application in the kitchen

### ESEMPI DI APPLICAZIONE LATO FIANCO CON SCHIENALE APPLICATION EXAMPLES SIDE SIDE WITH BACK PANEL

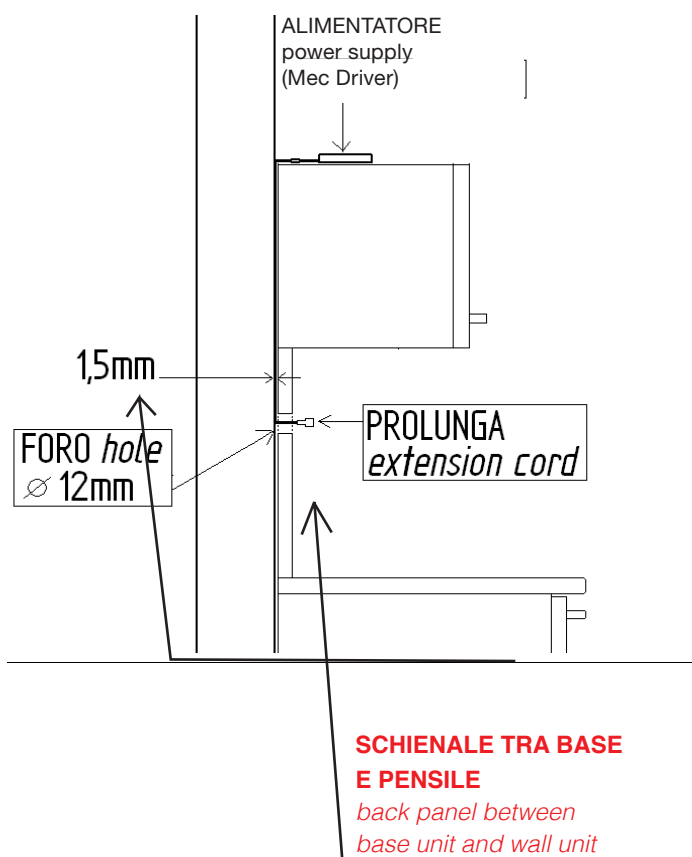



GRUPPO LUBE



# Modular



# MODULAR SENZA SCHIENA

MODULAR WITHOUT BACK PANEL

**Modulo cm 60-90-120 P 13**  
**tra base e pensile con ripiano.**  
**3 ganci predisposto per**  
**accessori**

Rack element  
 cm 60-90-120 D 13  
 between base unit and wall  
 unit with shelf.  
 3 hooks, suitable for  
 accessories

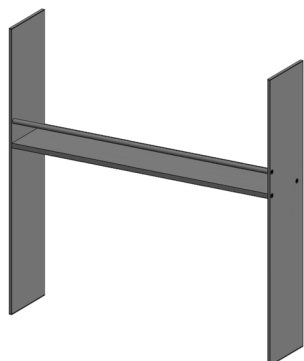

## TIPO A1

L 60

H 53 top sp.4  
 H 54 top sp.3  
 H 54,6 top sp.2,4  
 H 55 top sp.2  
 H 55,8 top sp.1,2

L 65

H 53 top sp.4  
 H 54 top sp.3  
 H 54,6 top sp.2,4  
 H 55 top sp.2  
 H 55,8 top sp.1,2

L 90

H 53 top sp.4  
 H 54 top sp.3  
 H 54,6 top sp.2,4  
 H 55 top sp.2  
 H 55,8 top sp.1,2

L 120

H 53 top sp.4  
 H 54 top sp.3  
 H 54,6 top sp.2,4  
 H 55 top sp.2  
 H 55,8 top sp.1,2

## TIPO A2

L 60

H 56 top sp.4  
 H 57 top sp.3  
 H 57,6 top sp.2,4  
 H 58 top sp.2  
 H 58,8 top sp.1,2

L 65

H 56 top sp.4  
 H 57 top sp.3  
 H 57,6 top sp.2,4  
 H 58 top sp.2  
 H 58,8 top sp.1,2

L 90

H 56 top sp.4  
 H 57 top sp.3  
 H 57,6 top sp.2,4  
 H 58 top sp.2  
 H 58,8 top sp.1,2

L 120

H 56 top sp.4  
 H 57 top sp.3  
 H 57,6 top sp.2,4  
 H 58 top sp.2  
 H 58,8 top sp.1,2

## TYPE A1

L 60

H 53 worktop th.4  
 H 54 worktop th.3  
 H 54,6 worktop th.2,4  
 H 55 worktop th.2  
 H 55,8 worktop th.1,2

L 65

H 53 worktop th.4  
 H 54 worktop th.3  
 H 54,6 worktop th.2,4  
 H 55 worktop th.2  
 H 55,8 worktop th.1,2

L 90

H 53 worktop th.4  
 H 54 worktop th.3  
 H 54,6 worktop th.2,4  
 H 55 worktop th.2  
 H 55,8 worktop th.1,2

L 120

H 53 worktop th.4  
 H 54 worktop th.3  
 H 54,6 worktop th.2,4  
 H 55 worktop th.2  
 H 55,8 worktop th.1,2

## TYPE A2

L 60

H 56 worktop th.4  
 H 57 worktop th.3  
 H 57,6 worktop th.2,4  
 H 58 worktop th.2  
 H 58,8 worktop th.1,2

L 65

H 56 worktop th.4  
 H 57 worktop th.3  
 H 57,6 worktop th.2,4  
 H 58 worktop th.2  
 H 58,8 worktop th.1,2

L 90

H 56 worktop th.4  
 H 57 worktop th.3  
 H 57,6 worktop th.2,4  
 H 58 worktop th.2  
 H 58,8 worktop th.1,2

L 120

H 56 worktop th.4  
 H 57 worktop th.3  
 H 57,6 worktop th.2,4  
 H 58 worktop th.2  
 H 58,8 worktop th.1,2

**CODICE**  
**CODE No.**

**ACCIAIO**  
 STEEL

**TITANIO**  
 TITANIUM

**BRUNITO**  
 BURNISHED

**086MA1160**  
**086MA1360**  
**086MA1560**  
**086MA1760**  
**086MA1960**

**086MA1165**  
**086MA1365**  
**086MA1565**  
**086MA1765**  
**086MA1965**

**086MA1190**  
**086MA1390**  
**086MA1590**  
**086MA1790**  
**086MA1990**

**086MA1195**  
**086MA1395**  
**086MA1595**  
**086MA1795**  
**086MA1995**

**086MA2160**  
**086MA2360**  
**086MA2560**  
**086MA2760**  
**086MA2960**

**086MA2165**  
**086MA2365**  
**086MA2565**  
**086MA2765**  
**086MA2965**

**086MA2190**  
**086MA2390**  
**086MA2590**  
**086MA2790**  
**086MA2990**

**086MA2195**  
**086MA2395**  
**086MA2595**  
**086MA2795**  
**086MA2995**

## Finiture "MODULAR"

"MODULAR" finishes



**Acciaio (opz.A)**  
 Stainless Steel



**Titanio (opz.T)**  
 Titanium



**Brunito (opz.B)**  
 Burnished

# MODULAR SENZA SCHIENA

MODULAR WITHOUT BACK PANEL

**Modulo cm 60-90-120 P 13**  
in appoggio con cielo e ripiano.

Lean on rack element  
cm 60-90-120 D 13  
with top panel and shelf.

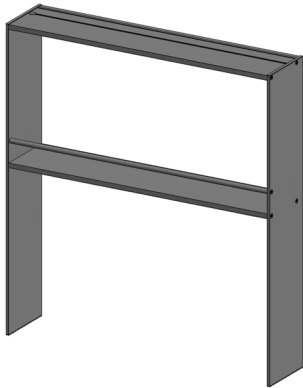

**TIPO B1**  
L 60

H 65 top sp.4  
H 66 top sp.3  
H 66,6 top sp.2,4  
H 67 top sp.2  
H 67,8 top sp.1,2

L 65

H 65 top sp.4  
H 66 top sp.3  
H 66,6 top sp.2,4  
H 67 top sp.2  
H 67,8 top sp.1,2

L 90

H 65 top sp.4  
H 66 top sp.3  
H 66,6 top sp.2,4  
H 67 top sp.2  
H 67,8 top sp.1,2

L 120

H 65 top sp.4  
H 66 top sp.3  
H 66,6 top sp.2,4  
H 67 top sp.2  
H 67,8 top sp.1,2

**TIPO B2**  
L 60

H 68 top sp.4  
H 69 top sp.3  
H 69,6 top sp.2,4  
H 70 top sp.2  
H 70,8 top sp.1,2

L 65

H 68 top sp.4  
H 69 top sp.3  
H 69,6 top sp.2,4  
H 70 top sp.2  
H 70,8 top sp.1,2

L 90

H 68 top sp.4  
H 69 top sp.3  
H 69,6 top sp.2,4  
H 70 top sp.2  
H 70,8 top sp.1,2

L 120

H 68 top sp.4  
H 69 top sp.3  
H 69,6 top sp.2,4  
H 70 top sp.2  
H 70,8 top sp.1,2

**TYPE B1**  
L 60

H 65 worktop th.4  
H 66 worktop th.3  
H 66,6 worktop th.2,4  
H 67 worktop th.2  
H 67,8 worktop th.1,2

L 65

H 65 worktop th.4  
H 66 worktop th.3  
H 66,6 worktop th.2,4  
H 67 worktop th.2  
H 67,8 worktop th.1,2

L 90

H 65 worktop th.4  
H 66 worktop th.3  
H 66,6 worktop th.2,4  
H 67 worktop th.2  
H 67,8 worktop th.1,2

L 120

H 65 worktop th.4  
H 66 worktop th.3  
H 66,6 worktop th.2,4  
H 67 worktop th.2  
H 67,8 worktop th.1,2

**TYPE B2**  
L 60

H 68 worktop th.4  
H 69 worktop th.3  
H 69,6 worktop th.2,4  
H 70 worktop th.2  
H 70,8 worktop th.1,2

L 65

H 68 worktop th.4  
H 69 worktop th.3  
H 69,6 worktop th.2,4  
H 70 worktop th.2  
H 70,8 worktop th.1,2

L 90

H 68 worktop th.4  
H 69 worktop th.3  
H 69,6 worktop th.2,4  
H 70 worktop th.2  
H 70,8 worktop th.1,2

L 120

H 68 worktop th.4  
H 69 worktop th.3  
H 69,6 worktop th.2,4  
H 70 worktop th.2  
H 70,8 worktop th.1,2

**CODICE**  
CODE No.

**ACCIAIO**  
STEEL

**TITANIO**  
TITANIUM

**BRUNITO**  
BURNISHED

086MA3160  
086MA3360  
086MA3560  
086MA3760  
086MA3960

086MA3165  
086MA3365  
086MA3565  
086MA3765  
086MA3965

086MA3190  
086MA3390  
086MA3590  
086MA3790  
086MA3990

086MA3195  
086MA3395  
086MA3595  
086MA3795  
086MA3995

086MA4160  
086MA4360  
086MA4560  
086MA4760  
086MA4960

086MA4165  
086MA4365  
086MA4565  
086MA4765  
086MA4965

086MA4190  
086MA4390  
086MA4590  
086MA4790  
086MA4990

086MA4195  
086MA4395  
086MA4595  
086MA4795  
086MA4995



# MODULAR SENZA SCHIENA

MODULAR WITHOUT BACK PANEL

**Modulo cm 60-90-120 P 13**  
in appoggio con cielo e 2 ripiani.

Lean on rack element  
cm 60-90-120 D 13  
with top panel and 2 shelves.

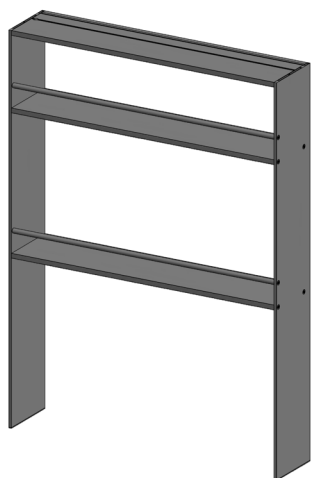

### TIPO C1

**L 60**  
H 77 top sp.4  
H 78 top sp.3  
H 78,6 top sp.2,4  
H 79 top sp.2  
H 79,8 top sp.1,2

**L 65**  
H 77 top sp.4  
H 78 top sp.3  
H 78,6 top sp.2,4  
H 79 top sp.2  
H 79,8 top sp.1,2

**L 90**  
H 77 top sp.4  
H 78 top sp.3  
H 78,6 top sp.2,4  
H 79 top sp.2  
H 79,8 top sp.1,2

**L 120**  
H 77 top sp.4  
H 78 top sp.3  
H 78,6 top sp.2,4  
H 79 top sp.2  
H 79,8 top sp.1,2

### TIPO C2

**L 60**  
H 80 top sp.4  
H 81 top sp.3  
H 81,6 top sp.2,4  
H 82 top sp.2  
H 82,8 top sp.1,2

**L 65**  
H 80 top sp.4  
H 81 top sp.3  
H 81,6 top sp.2,4  
H 82 top sp.2  
H 82,8 top sp.1,2

**L 90**  
H 80 top sp.4  
H 81 top sp.3  
H 81,6 top sp.2,4  
H 82 top sp.2  
H 82,8 top sp.1,2

**L 120**  
H 80 top sp.4  
H 81 top sp.3  
H 81,6 top sp.2,4  
H 82 top sp.2  
H 82,8 top sp.1,2

### TYPE C1

**L 60**  
H 77 worktop th.4  
H 78 worktop th.3  
H 78,6 worktop th.2,4  
H 79 worktop th.2  
H 79,8 worktop th.1,2

**L 65**  
H 77 worktop th.4  
H 78 worktop th.3  
H 78,6 worktop th.2,4  
H 79 worktop th.2  
H 79,8 worktop th.1,2

**L 90**  
H 77 worktop th.4  
H 78 worktop th.3  
H 78,6 worktop th.2,4  
H 79 worktop th.2  
H 79,8 worktop th.1,2

**L 120**  
H 77 worktop th.4  
H 78 worktop th.3  
H 78,6 worktop th.2,4  
H 79 worktop th.2  
H 79,8 worktop th.1,2

### TYPE C2

**L 60**  
H 80 worktop th.4  
H 81 worktop th.3  
H 81,6 worktop th.2,4  
H 82 worktop th.2  
H 82,8 worktop th.1,2

**L 65**  
H 80 worktop th.4  
H 81 worktop th.3  
H 81,6 worktop th.2,4  
H 82 worktop th.2  
H 82,8 worktop th.1,2

**L 90**  
H 80 worktop th.4  
H 81 worktop th.3  
H 81,6 worktop th.2,4  
H 82 worktop th.2  
H 82,8 worktop th.1,2

**L 120**  
H 80 worktop th.4  
H 81 worktop th.3  
H 81,6 worktop th.2,4  
H 82 worktop th.2  
H 82,8 worktop th.1,2

**CODICE**  
*CODE No.*

**ACCIAIO**  
STEEL

**TITANIO**  
TITANIUM

**BRUNITO**  
BURNISHED

**086MA5160**  
**086MA5360**  
**086MA5560**  
**086MA5760**  
**086MA5960**

**086MA5165**  
**086MA5365**  
**086MA5565**  
**086MA5765**  
**086MA5965**

**086MA5190**  
**086MA5390**  
**086MA5590**  
**086MA5790**  
**086MA5990**

**086MA5195**  
**086MA5395**  
**086MA5595**  
**086MA5795**  
**086MA5995**

**086MA6160**  
**086MA6360**  
**086MA6560**  
**086MA6760**  
**086MA6960**

**086MA6165**  
**086MA6365**  
**086MA6565**  
**086MA6765**  
**086MA6965**

**086MA6190**  
**086MA6390**  
**086MA6590**  
**086MA6790**  
**086MA6990**

**086MA6195**  
**086MA6395**  
**086MA6595**  
**086MA6795**  
**086MA6995**

## Finiture "MODULAR"

"MODULAR" finishes



**Acciaio (opz.A)**  
Stainless Steel



**Titanio (opz.T)**  
Titanium



**Brunito (opz.B)**  
Burnished

# MODULAR SENZA SCHIENA

MODULAR WITHOUT BACK PANEL

**Modulo cm 60-90-120 P 13**  
in appoggio con cielo e 2 ripiani.

Lean on rack element  
cm 60-90-120 D 13  
with top panel and 2 shelves.

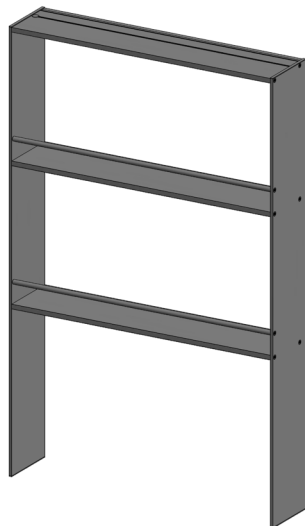

## TIPO D1

L 60

H 89 top sp.4  
H 90 top sp.3  
H 90,6 top sp.2,4  
H 91 top sp.2  
H 91,8 top sp.1,2

L 65

H 89 top sp.4  
H 90 top sp.3  
H 90,6 top sp.2,4  
H 91 top sp.2  
H 91,8 top sp.1,2

L 90

H 89 top sp.4  
H 90 top sp.3  
H 90,6 top sp.2,4  
H 91 top sp.2  
H 91,8 top sp.1,2

L 120

H 89 top sp.4  
H 90 top sp.3  
H 90,6 top sp.2,4  
H 91 top sp.2  
H 91,8 top sp.1,2

## TIPO D2

L 60

H 92 top sp.4  
H 93 top sp.3  
H 93,6 top sp.2,4  
H 94 top sp.2  
H 94,8 top sp.1,2

L 65

H 92 top sp.4  
H 93 top sp.3  
H 93,6 top sp.2,4  
H 94 top sp.2  
H 94,8 top sp.1,2

L 90

H 92 top sp.4  
H 93 top sp.3  
H 93,6 top sp.2,4  
H 94 top sp.2  
H 94,8 top sp.1,2

L 120

H 92 top sp.4  
H 93 top sp.3  
H 93,6 top sp.2,4  
H 94 top sp.2  
H 94,8 top sp.1,2

## TYPE D1

L 60

H 89 worktop th.4  
H 90 worktop th.3  
H 90,6 worktop th.2,4  
H 91 worktop th.2  
H 91,8 worktop th.1,2

L 65

H 89 worktop th.4  
H 90 worktop th.3  
H 90,6 worktop th.2,4  
H 91 worktop th.2  
H 91,8 worktop th.1,2

L 90

H 89 worktop th.4  
H 90 worktop th.3  
H 90,6 worktop th.2,4  
H 91 worktop th.2  
H 91,8 worktop th.1,2

L 120

H 89 worktop th.4  
H 90 worktop th.3  
H 90,6 worktop th.2,4  
H 91 worktop th.2  
H 91,8 worktop th.1,2

## TYPE D2

L 60

H 92 worktop th.4  
H 93 worktop th.3  
H 93,6 worktop th.2,4  
H 94 worktop th.2  
H 94,8 worktop th.1,2

L 65

H 92 worktop th.4  
H 93 worktop th.3  
H 93,6 worktop th.2,4  
H 94 worktop th.2  
H 94,8 worktop th.1,2

L 90

H 92 worktop th.4  
H 93 worktop th.3  
H 93,6 worktop th.2,4  
H 94 worktop th.2  
H 94,8 worktop th.1,2

L 120

H 92 worktop th.4  
H 93 worktop th.3  
H 93,6 worktop th.2,4  
H 94 worktop th.2  
H 94,8 worktop th.1,2

**CODICE**  
*CODE No.*

**ACCIAIO**  
STEEL

**TITANIO**  
TITANIUM

**BRUNITO**  
BURNISHED

**086MB1160**  
**086MB1360**  
**086MB1560**  
**086MB1760**  
**086MB1960**

**086MB1165**  
**086MB1365**  
**086MB1565**  
**086MB1765**  
**086MB1965**

**086MB1190**  
**086MB1390**  
**086MB1590**  
**086MB1790**  
**086MB1990**

**086MB1195**  
**086MB1395**  
**086MB1595**  
**086MB1795**  
**086MB1995**

**086MB2160**  
**086MB2360**  
**086MB2560**  
**086MB2760**  
**086MB2960**

**086MB2165**  
**086MB2365**  
**086MB2565**  
**086MB2765**  
**086MB2965**

**086MB2190**  
**086MB2390**  
**086MB2590**  
**086MB2790**  
**086MB2990**

**086MB2195**  
**086MB2395**  
**086MB2595**  
**086MB2795**  
**086MB2995**

## Finiture "MODULAR"

"MODULAR" finishes



**Acciaio (opz.A)**  
Stainless Steel



**Titanio (opz.T)**  
Titanium



**Brunito (opz.B)**  
Burnished

# MODULAR SENZA SCHIENA

MODULAR WITHOUT BACK PANEL

**Modulo cm 60-90-120 P 13**  
in appoggio con cielo e 2 ripiani.

Lean on rack element  
cm 60-90-120 D 13  
with top panel and 2 shelves.

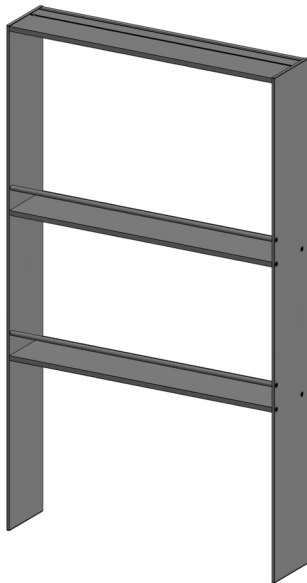

### TIPO E1

**L 60**

H 101 top sp.4  
H 102 top sp.3  
H 102,6 top sp.2,4  
H 103 top sp.2  
H 103,8 top sp.1,2

**L 65**

H 101 top sp.4  
H 102 top sp.3  
H 102,6 top sp.2,4  
H 103 top sp.2  
H 103,8 top sp.1,2

**L 90**

H 101 top sp.4  
H 102 top sp.3  
H 102,6 top sp.2,4  
H 103 top sp.2  
H 103,8 top sp.1,2

**L 120**

H 101 top sp.4  
H 102 top sp.3  
H 102,6 top sp.2,4  
H 103 top sp.2  
H 103,8 top sp.1,2

### TIPO E2

**L 60**

H 104 top sp.4  
H 105 top sp.3  
H 105,6 top sp.2,4  
H 106 top sp.2  
H 106,8 top sp.1,2

**L 65**

H 104 top sp.4  
H 105 top sp.3  
H 105,6 top sp.2,4  
H 106 top sp.2  
H 106,8 top sp.1,2

**L 90**

H 104 top sp.4  
H 105 top sp.3  
H 105,6 top sp.2,4  
H 106 top sp.2  
H 106,8 top sp.1,2

**L 120**

H 104 top sp.4  
H 105 top sp.3  
H 105,6 top sp.2,4  
H 106 top sp.2  
H 106,8 top sp.1,2

### TYPE E1

**L 60**

H 101 worktop th.4  
H 102 worktop th.3  
H 102,6 worktop th.2,4  
H 103 worktop th.2  
H 103,8 worktop th.1,2

**L 65**

H 101 worktop th.4  
H 102 worktop th.3  
H 102,6 worktop th.2,4  
H 103 worktop th.2  
H 103,8 worktop th.1,2

**L 90**

H 101 worktop th.4  
H 102 worktop th.3  
H 102,6 worktop th.2,4  
H 103 worktop th.2  
H 103,8 worktop th.1,2

**L 120**

H 101 worktop th.4  
H 102 worktop th.3  
H 102,6 worktop th.2,4  
H 103 worktop th.2  
H 103,8 worktop th.1,2

### TYPE E2

**L 60**

H 104 worktop th.4  
H 105 worktop th.3  
H 105,6 worktop th.2,4  
H 106 worktop th.2  
H 106,8 worktop th.1,2

**L 60**

H 104 worktop th.4  
H 105 worktop th.3  
H 105,6 worktop th.2,4  
H 106 worktop th.2  
H 106,8 worktop th.1,2

**L 90**

H 104 worktop th.4  
H 105 worktop th.3  
H 105,6 worktop th.2,4  
H 106 worktop th.2  
H 106,8 worktop th.1,2

**L 120**

H 104 worktop th.4  
H 105 worktop th.3  
H 105,6 worktop th.2,4  
H 106 worktop th.2  
H 106,8 worktop th.1,2

**CODICE**  
*CODE No.*

**ACCIAIO**  
STEEL

**TITANIO**  
TITANIUM

**BRUNITO**  
BURNISHED

**086MB3160**  
**086MB3360**  
**086MB3560**  
**086MB3760**  
**086MB3960**

**086MB3165**  
**086MB3365**  
**086MB3565**  
**086MB3765**  
**086MB3965**

**086MB3190**  
**086MB3390**  
**086MB3590**  
**086MB3790**  
**086MB3990**

**086MB3195**  
**086MB3395**  
**086MB3595**  
**086MB3795**  
**086MB3995**

**086MB4160**  
**086MB4360**  
**086MB4560**  
**086MB4760**  
**086MB4960**

**086MB4165**  
**086MB4365**  
**086MB4565**  
**086MB4765**  
**086MB4965**

**086MB4190**  
**086MB4390**  
**086MB4590**  
**086MB4790**  
**086MB4990**

**086MB4195**  
**086MB4395**  
**086MB4595**  
**086MB4795**  
**086MB4995**

## Finiture "MODULAR"

"MODULAR" finishes



**Acciaio (opz.A)**  
Stainless Steel



**Titanio (opz.T)**  
Titanium



**Brunito (opz.B)**  
Burnished



# MODULAR SENZA SCHIENA

MODULAR WITHOUT BACK PANEL

**Modulo cm 60-90 P 13**  
in appoggio con cielo e 3 ripiani.

Lean on rack element  
cm 60-90-120 D 13  
with top panel and 3 shelves.

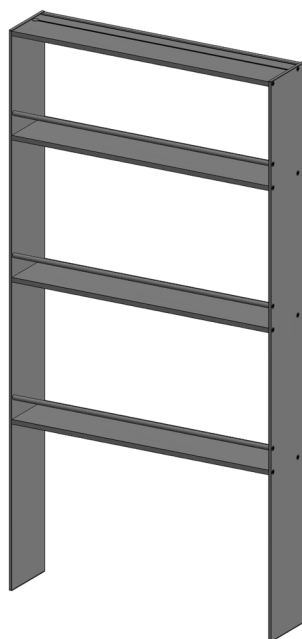

## TIPO F1

**L 60**

H 125 top sp.4  
H 126 top sp.3  
H 126,6 top sp.2,4  
H 127 top sp.2  
H 127,8 top sp.1,2

**L 65**

H 125 top sp.4  
H 126 top sp.3  
H 126,6 top sp.2,4  
H 127 top sp.2  
H 127,8 top sp.1,2

**L 90**

H 125 top sp.4  
H 126 top sp.3  
H 126,6 top sp.2,4  
H 127 top sp.2  
H 127,8 top sp.1,2

## TIPO F2

**L 60**

H 128 top sp.4  
H 129 top sp.3  
H 129,6 top sp.2,4  
H 130 top sp.2  
H 130,8 top sp.1,2

**L 65**

H 128 top sp.4  
H 129 top sp.3  
H 129,6 top sp.2,4  
H 130 top sp.2  
H 130,8 top sp.1,2

**L 90**

H 128 top sp.4  
H 129 top sp.3  
H 129,6 top sp.2,4  
H 130 top sp.2  
H 130,8 top sp.1,2

## TYPE F1

**L 60**

H 125 worktop th.4  
H 126 worktop th.3  
H 126,6 worktop th.2,4  
H 127 worktop th.2  
H 127,8 worktop th.1,2

**L 65**

H 125 worktop th.4  
H 126 worktop th.3  
H 126,6 worktop th.2,4  
H 127 worktop th.2  
H 127,8 worktop th.1,2

**L 90**

H 125 worktop th.4  
H 126 worktop th.3  
H 126,6 worktop th.2,4  
H 127 worktop th.2  
H 127,8 worktop th.1,2

## TYPE F2

**L 60**

H 128 worktop th.4  
H 129 worktop th.3  
H 129,6 worktop th.2,4  
H 130 worktop th.2  
H 130,8 worktop th.1,2

**L 65**

H 128 worktop th.4  
H 129 worktop th.3  
H 129,6 worktop th.2,4  
H 130 worktop th.2  
H 130,8 worktop th.1,2

**L 90**

H 128 worktop th.4  
H 129 worktop th.3  
H 129,6 worktop th.2,4  
H 130 worktop th.2  
H 130,8 worktop th.1,2

**CODICE**  
*CODE No.*

**ACCIAIO**  
STEEL

**TITANIO**  
TITANIUM

**BRUNITO**  
BURNISHED

**086MA7160**  
**086MA7360**  
**086MA7560**  
**086MA7760**  
**086MA7960**

**086MA7165**  
**086MA7365**  
**086MA7565**  
**086MA7765**  
**086MA7965**

**086MA7190**  
**086MA7390**  
**086MA7590**  
**086MA7790**  
**086MA7990**

**086MA8160**  
**086MA8360**  
**086MA8560**  
**086MA8760**  
**086MA8960**

**086MA8165**  
**086MA8365**  
**086MA8565**  
**086MA8765**  
**086MA8965**

**086MA8190**  
**086MA8390**  
**086MA8590**  
**086MA8790**  
**086MA8990**

## Finiture "MODULAR"

"MODULAR" finishes



**Acciaio (opz.A)**  
Stainless Steel



**Titanio (opz.T)**  
Titanium



**Brunito (opz.B)**  
Burnished

# MODULAR SOSPESO SENZA SCHIENA

MODULAR SUSPENDED WITHOUT BACK PANEL

**Modulo H 132 P 13**  
**sospeso con cielo e 4 ripiani.**

Hanging rack element  
 H 132 D 13  
 with top panel and 4 shelves.

**CODICE**  
**CODE No.**

**ACCIAIO**  
 STEEL

**TITANIO**  
 TITANIUM

**BRUNITO**  
 BURNISHED

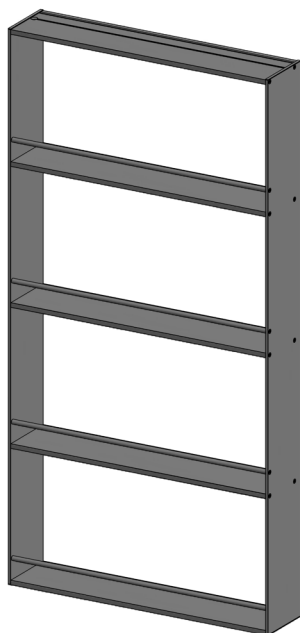

L 60  
 L 90

W 60  
 W 90

**086MB9060**  
**086MB9090**



# MODULAR CON SCHIENALI

MODULAR WITH BACK PANELS



# MODULAR COLORI SCHIENALI

MODULAR COLOURS BACK PANELS

## COLORI MELAMICI MODELLO IMMAGINA PLUS

IMMAGINA PLUS MODEL MELAMINE COLOURS

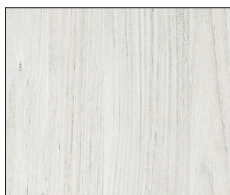

**cansiglio bianco**  
(opz.1561)  
white cansiglio

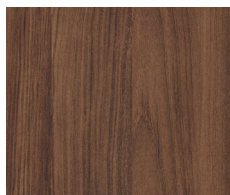

**cansiglio terra bruciata**  
(opz.1562)  
scorched earth cansiglio



**cansiglio grigio fumo**  
(opz.1563)  
smoke grey cansiglio

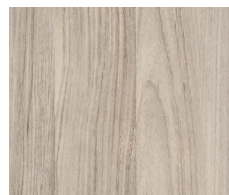

**cansiglio sabbia**  
(opz.1564)  
sand cansiglio



**cansiglio champagne**  
(opz.1565)  
champagne cansiglio



**larice baglia**  
(opz.1826)  
baglia larch

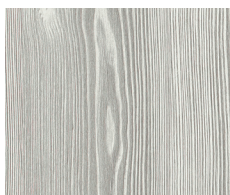

**larice laguna**  
(opz.1827)  
lagoon larch

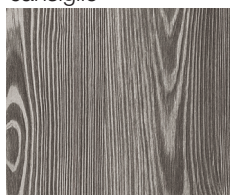

**larice vulcano**  
(opz.1828)  
volcano larch

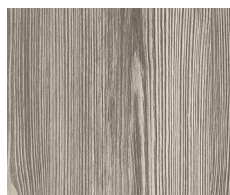

**larice terra**  
(opz.1829)  
earth larch

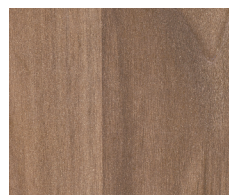

**noce**  
(opz.2363)  
walnut



**cemento**  
(opz.9633)  
cement



**bianco cristallo**  
(opz.7445)  
crystal white



**grigio nebbia**  
(opz.9626)  
fog grey



**castoro**  
(opz.8862)  
beaver

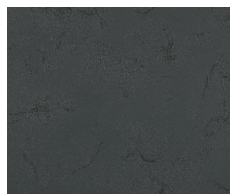

**lavagna**  
(opz.9627)  
slate grey



**juta**  
(opz.8863)  
jute

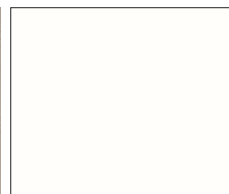

**bianco assoluto**  
(opz.7441)  
absolute white

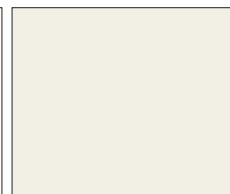

**bianco neve**  
(opz.750)  
snow white



**grigio sasso**  
(opz.9650)  
pebble grey



**verde marino**  
(opz.8402)  
sea green

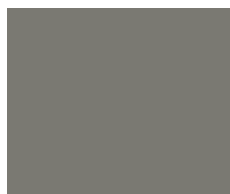

**grigio monzone**  
(opz.9651)  
monsoon grey



**grigio notte**  
(opz.9652)  
midnight grey



**grigio velo**  
(opz.9653)  
veil grey

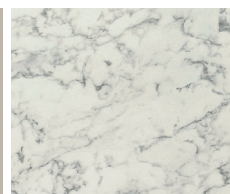

**marmo baron**  
(opz.9632)  
baron marble



**nichel**  
(opz.9660)  
nickel

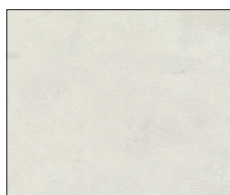

**platino**  
(opz.9661)  
platinum



**zinco**  
(opz.9662)  
zinc



**peltro**  
(opz.9666)  
pewter



**titanio**  
(opz.9665)  
titanium



**olmo bianco**  
(opz.5001)  
white elm

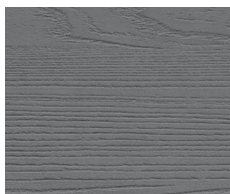

**olmo antracite**  
(opz.5004)  
anthracite elm

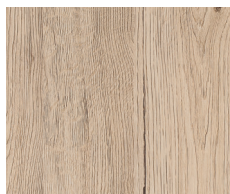

**oak miele**  
(opz.1361)  
honey oak



**oak neve**  
(opz.1362)  
snow oak

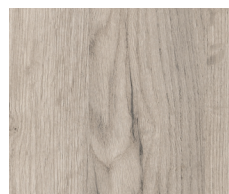

**oak cognac**  
(opz.1363)  
cognac oak

# MODULAR COLORI SCHIENALI

MODULAR COLOURS BACK PANELS

## COLORI MELAMICI MODELLO TABLET - JEY FEEL - SMART

TABLET - JEY FEEL - SMART MODEL MELAMINE COLOURS



**rovere luna**  
(opz.5316)  
moon oak

**rovere venere**  
(opz.5315)  
venus oak

**rovere arizona**  
(opz.5317)  
arizona oak

**rovere dark**  
(opz.5318)  
dark oak

**frassino lava**  
(opz.2408)  
lava ash

**frassino sabbia**  
(opz.2406)  
sand ash

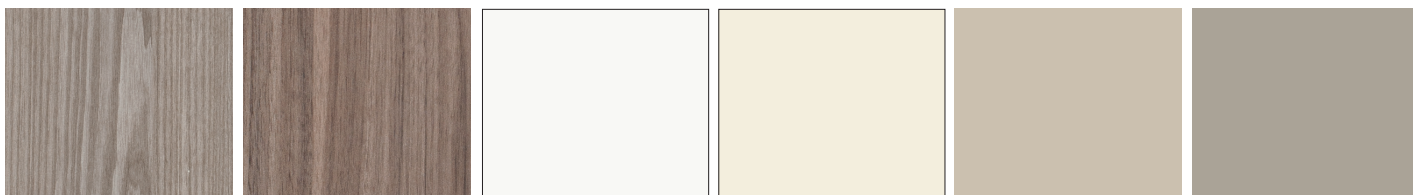

**frassino pietra**  
(opz.2407)  
stone ash

**noce brown**  
(opz.2371)  
brown walnut

**bianco soft matt**  
(opz.7447N)  
soft matt white

**porcellana soft matt**  
(opz.7703N)  
soft matt porcelain

**desert soft matt**  
(opz.8914N)  
soft matt desert

**molaria soft matt**  
(opz.9636N)  
soft matt molaria



**arena soft matt** (opz.9637N)  
soft matt arena

**bianco**  
(opz.9639)  
white

**bronzo**  
(opz.8866)  
bronze

**ardesia**  
(opz.9638)  
slate grey

**rovere silver**  
(opz.5306)  
silver oak

**rovere diamond**  
(opz.5307)  
diamond oak



**rovere tabià**  
(opz.5309)  
tabià oak

**rovere ortisei**  
(opz.5305)  
ortisei oak

**trani**  
(opz.7704)  
trani

**black**  
(opz.7863)  
black

**white**  
(opz.7448)  
white

**grigio agata**  
(opz.9623)  
agata grey



**grigio inox**  
(opz.9624)  
stainless steel grey

**rosso cardinale**  
(opz.8123)  
cardinal red

**frassino bianco alpino**  
(opz.2310)  
alpine-white ash

**rovere greige**  
(opz.2320)  
greige oak

**betulla**  
(opz.2311)  
birch

## COLORI STRUTTURE

CARCASSES COLOURS



**bianco** (opz.001)  
white

**visone** (opz.948M)  
mink

**lavagna** (opz.9620)  
slate grey

**fango** (opz.8860)  
mud

**conchiglia** (opz.8910)  
shell

**argilla** (opz.9690)  
clay

# MODULAR COLORI SCHIENALI

MODULAR COLOURS BACK PANELS

## COLORI FENIX

FENIX COLOURS

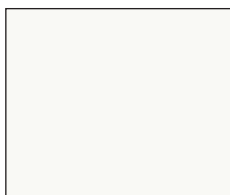

**bianco caldo**  
(opz.0032)  
warm white



**castoro**  
(opz.0717)  
beaver



**fumo**  
(opz.0718)  
smoke



**nero**  
(opz.0720)  
black

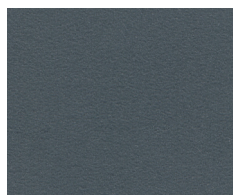

**grigio bromo**  
(opz.0724)  
bromine grey

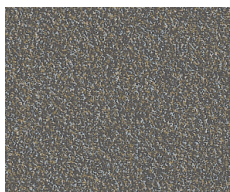

**bronzo doha**  
(opz.2629)  
doha bronze



**beige arizona**  
(opz.0748)  
arizona beige

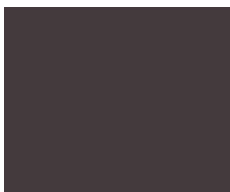

**cacao orinoco**  
(opz.0749)  
orinoco cocoa

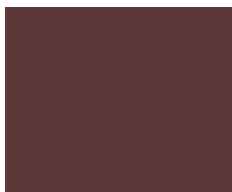

**rosso jaipur**  
(opz.0751)  
jaipur red



**verde commodoro**  
(opz.0750)  
commodoro green



**grigio antrim**  
(opz.0752)  
antrim grey

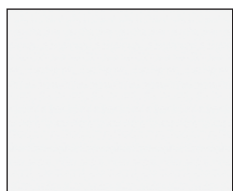

**bianco dover**  
(opz.0757)  
dover white



**grigio efeso**  
(opz.0725)  
ephesus grey

## COLORI EFFETTO MARMO

MARBLE EFFECT COLOURS

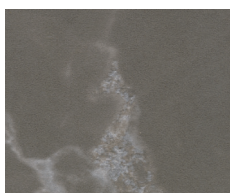

**perlato finitura ker**  
(opz.3443)  
pearly with ker finish

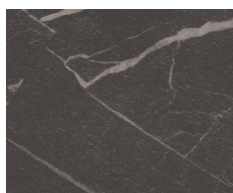

**alabastro finitura mn**  
(opz.6014)  
alabaster with mn finish



**calacatta finitura mn**  
(opz.6019)  
calacatta with mn finish

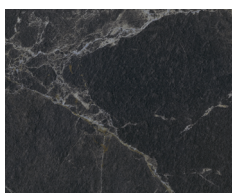

**dark finitura mn**  
(opz.6133)  
dark with mn finish

## COLORI WOOD IMPIALLACCIATO MODELLO IMMAGINA - TABLET

IMMAGINA - TABLET MODEL VENEERED COLOURS

**N.B: non utilizzati per gli elementi da 120**

**Note: not used for 120 elements**

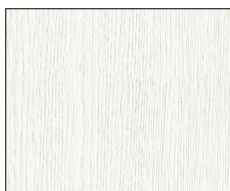

**rovere bianco**  
(opz.5441)  
white oak

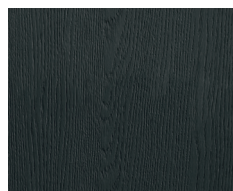

**rovere nero**  
(opz.5446)  
black oak



**rovere moscato**  
(opz.5444)  
muscat oak

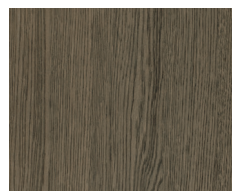

**rovere fumè**  
(opz.5445)  
smoked oak

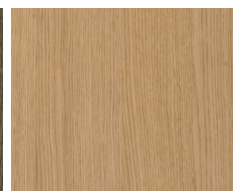

**rovere naturale**  
(opz.5442)  
natural oak

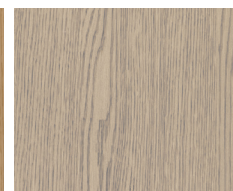

**rovere grey**  
(opz.5443)  
grey oak

# MODULAR CON SCHIENALE

## MODULAR WITH BACK PANEL

**Modulo cm 60-90-120 P 15,3**  
**tra base e pensile con ripiano.**  
**3 ganci predisposto per**  
**accessori**

Rack element  
 cm 60-90-120 D 15,3  
 between base unit and wall  
 unit with shelf.  
 3 hooks suitable for  
 accessories.

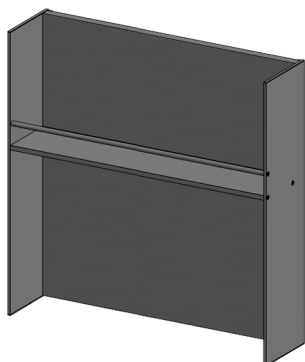

### TIPO A1

#### L 60

H 53 top sp.4  
 H 54 top sp.3  
 H 54,6 top sp.2,4  
 H 55 top sp.2  
 H 55,8 top sp.1,2

#### L 65

H 53 top sp.4  
 H 54 top sp.3  
 H 54,6 top sp.2,4  
 H 55 top sp.2  
 H 55,8 top sp.1,2

#### L 90

H 53 top sp.4  
 H 54 top sp.3  
 H 54,6 top sp.2,4  
 H 55 top sp.2  
 H 55,8 top sp.1,2

#### L 120

H 53 top sp.4  
 H 54 top sp.3  
 H 54,6 top sp.2,4  
 H 55 top sp.2  
 H 55,8 top sp.1,2

### TIPO A2

#### L 60

H 56 top sp.4  
 H 57 top sp.3  
 H 57,6 top sp.2,4  
 H 58 top sp.2  
 H 58,8 top sp.1,2

#### L 65

H 56 top sp.4  
 H 57 top sp.3  
 H 57,6 top sp.2,4  
 H 58 top sp.2  
 H 58,8 top sp.1,2

#### L 90

H 56 top sp.4  
 H 57 top sp.3  
 H 57,6 top sp.2,4  
 H 58 top sp.2  
 H 58,8 top sp.1,2

#### L 120

H 56 top sp.4  
 H 57 top sp.3  
 H 57,6 top sp.2,4  
 H 58 top sp.2  
 H 58,8 top sp.1,2

### TYPE A1

#### L 60

H 53 worktop th.4  
 H 54 worktop th.3  
 H 54,6 worktop th.2,4  
 H 55 worktop th.2  
 H 55,8 worktop th.1,2

#### L 65

H 53 worktop th.4  
 H 54 worktop th.3  
 H 54,6 worktop th.2,4  
 H 55 worktop th.2  
 H 55,8 worktop th.1,2

#### L 90

H 53 worktop th.4  
 H 54 worktop th.3  
 H 54,6 worktop th.2,4  
 H 55 worktop th.2  
 H 55,8 worktop th.1,2

#### L 120

H 53 worktop th.4  
 H 54 worktop th.3  
 H 54,6 worktop th.2,4  
 H 55 worktop th.2  
 H 55,8 worktop th.1,2

### TYPE A2

#### L 60

H 56 worktop th.4  
 H 57 worktop th.3  
 H 57,6 worktop th.2,4  
 H 58 worktop th.2  
 H 58,8 worktop th.1,2

#### L 65

H 56 worktop th.4  
 H 57 worktop th.3  
 H 57,6 worktop th.2,4  
 H 58 worktop th.2  
 H 58,8 worktop th.1,2

#### L 90

H 56 worktop th.4  
 H 57 worktop th.3  
 H 57,6 worktop th.2,4  
 H 58 worktop th.2  
 H 58,8 worktop th.1,2

#### L 120

H 56 worktop th.4  
 H 57 worktop th.3  
 H 57,6 worktop th.2,4  
 H 58 worktop th.2  
 H 58,8 worktop th.1,2

**CODICE**  
**CODE No.**

**ACCIAIO**  
 STEEL

**TITANIO**  
 TITANIUM

**BRUNITO**  
 BURNISHED

**086MC1160**  
**086MC1360**  
**086MC1560**  
**086MC1760**  
**086MC1960**

**086MC1165**  
**086MC1365**  
**086MC1565**  
**086MC1765**  
**086MC1965**

**086MC1190**  
**086MC1390**  
**086MC1590**  
**086MC1790**  
**086MC1990**

**086MC1195**  
**086MC1395**  
**086MC1595**  
**086MC1795**  
**086MC1995**

**086MC2160**  
**086MC2360**  
**086MC2560**  
**086MC2760**  
**086MC2960**

**086MC2165**  
**086MC2365**  
**086MC2565**  
**086MC2765**  
**086MC2965**

**086MC2190**  
**086MC2390**  
**086MC2590**  
**086MC2790**  
**086MC2990**

**086MC2195**  
**086MC2395**  
**086MC2595**  
**086MC2795**  
**086MC2995**

SCHIENALI FENIX

FENIX BACK PANELS

SCHIENALI EFFETTO MARMO

EFFECT MARBLE BACK PANELS

SCHIENALI IMPIALLACCIATI WOOD

**N.B.: non utilizzati per gli elementi da 120**

WOOD VENEERED BACK PANELS

**Note: not used for 120 elements**



# MODULAR CON SCHIENALE

MODULAR WITH BACK PANEL

Modulo cm 60-90-120 P 15,3  
in appoggio con cielo e ripiano.

Lean on rack element  
cm 60-90-120 D 15,3  
with top panel and shelf.

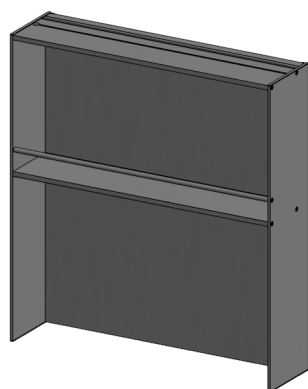

## TIPO B1

L 60

H 65 top sp.4  
H 66 top sp.3  
H 66,6 top sp.2,4  
H 67 top sp.2  
H 67,8 top sp.1,2

## L 65

H 65 top sp.4  
H 66 top sp.3  
H 66,6 top sp.2,4  
H 67 top sp.2  
H 67,8 top sp.1,2

## L 90

H 65 top sp.4  
H 66 top sp.3  
H 66,6 top sp.2,4  
H 67 top sp.2  
H 67,8 top sp.1,2

## L 120

H 65 top sp.4  
H 66 top sp.3  
H 66,6 top sp.2,4  
H 67 top sp.2  
H 67,8 top sp.1,2

## TIPO B2

L 60

H 68 top sp.4  
H 69 top sp.3  
H 69,6 top sp.2,4  
H 70 top sp.2  
H 70,8 top sp.1,2

## L 65

H 68 top sp.4  
H 69 top sp.3  
H 69,6 top sp.2,4  
H 70 top sp.2  
H 70,8 top sp.1,2

## L 90

H 68 top sp.4  
H 69 top sp.3  
H 69,6 top sp.2,4  
H 70 top sp.2  
H 70,8 top sp.1,2

## L 120

H 68 top sp.4  
H 69 top sp.3  
H 69,6 top sp.2,4  
H 70 top sp.2  
H 70,8 top sp.1,2

## TYPE B1

L 60

H 65 worktop th.4  
H 66 worktop th.3  
H 66,6 worktop th.2,4  
H 67 worktop th.2  
H 67,8 worktop th.1,2

## L 65

H 65 worktop th.4  
H 66 worktop th.3  
H 66,6 worktop th.2,4  
H 67 worktop th.2  
H 67,8 worktop th.1,2

## L 90

H 65 worktop th.4  
H 66 worktop th.3  
H 66,6 worktop th.2,4  
H 67 worktop th.2  
H 67,8 worktop th.1,2

## L 120

H 65 worktop th.4  
H 66 worktop th.3  
H 66,6 worktop th.2,4  
H 67 worktop th.2  
H 67,8 worktop th.1,2

## TYPE B2

L 60

H 68 worktop th.4  
H 69 worktop th.3  
H 69,6 worktop th.2,4  
H 70 worktop th.2  
H 70,8 worktop th.1,2

## L 65

H 68 worktop th.4  
H 69 worktop th.3  
H 69,6 worktop th.2,4  
H 70 worktop th.2  
H 70,8 worktop th.1,2

## L 90

H 68 worktop th.4  
H 69 worktop th.3  
H 69,6 worktop th.2,4  
H 70 worktop th.2  
H 70,8 worktop th.1,2

## L 120

H 68 worktop th.4  
H 69 worktop th.3  
H 69,6 worktop th.2,4  
H 70 worktop th.2  
H 70,8 worktop th.1,2

**CODICE**  
CODE No.

**ACCIAIO**  
STEEL

**TITANIO**  
TITANIUM

**BRUNITO**  
BURNISHED

086MC3160  
086MC3360  
086MC3560  
086MC3760  
086MC3960

086MC3165  
086MC3365  
086MC3565  
086MC3765  
086MC3965

086MC3190  
086MC3390  
086MC3590  
086MC3790  
086MC3990

086MC3195  
086MC3395  
086MC3595  
086MC3795  
086MC3995

086MC4160  
086MC4360  
086MC4560  
086MC4760  
086MC4960

086MC4165  
086MC4365  
086MC4565  
086MC4765  
086MC4965

086MC4190  
086MC4390  
086MC4590  
086MC4790  
086MC4990

086MC4195  
086MC4395  
086MC4595  
086MC4795  
086MC4995

SCHIENALI FENIX

FENIX BACK PANELS

SCHIENALI EFFETTO MARMO

EFFECT MARBLE BACK PANELS

SCHIENALI IMPIALLACCIATI WOOD

N.B.: non utilizzati per gli elementi da 120

WOOD VENEERED BACK PANELS

Note: not used for 120 elements

## Finiture "MODULAR"

"MODULAR" finishes



Acciaio (opz.A)  
Stainless Steel



Titanio (opz.T)  
Titanium



Brunito (opz.B)  
Burnished



# MODULAR CON SCHIENALE

MODULAR WITH BACK PANEL

Modulo cm 60-90-120 P 15,3  
in appoggio con cielo e 2 ripiani.

Lean on rack element  
cm 60-90-120 D 15,3  
with top panel and 2 shelves.

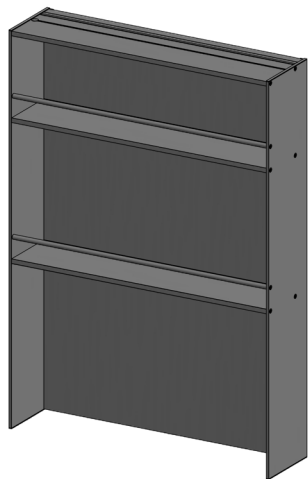

## TIPO C1

L 60

H 77 top sp.4  
H 78 top sp.3  
H 78,6 top sp.2,4  
H 79 top sp.2  
H 79,8 top sp.1,2

L 65

H 77 top sp.4  
H 78 top sp.3  
H 78,6 top sp.2,4  
H 79 top sp.2  
H 79,8 top sp.1,2

L 90

H 77 top sp.4  
H 78 top sp.3  
H 78,6 top sp.2,4  
H 79 top sp.2  
H 79,8 top sp.1,2

L 120

H 77 top sp.4  
H 78 top sp.3  
H 78,6 top sp.2,4  
H 79 top sp.2  
H 79,8 top sp.1,2

## TYPE C1

L 60

H 77 worktop th.4  
H 78 worktop th.3  
H 78,6 worktop th.2,4  
H 79 worktop th.2  
H 79,8 worktop th.1,2

L 65

H 77 worktop th.4  
H 78 worktop th.3  
H 78,6 worktop th.2,4  
H 79 worktop th.2  
H 79,8 worktop th.1,2

L 90

H 77 worktop th.4  
H 78 worktop th.3  
H 78,6 worktop th.2,4  
H 79 worktop th.2  
H 79,8 worktop th.1,2

L 120

H 77 worktop th.4  
H 78 worktop th.3  
H 78,6 worktop th.2,4  
H 79 worktop th.2  
H 79,8 worktop th.1,2

## TIPO C2

L 60

H 80 top sp.4  
H 81 top sp.3  
H 81,6 top sp.2,4  
H 82 top sp.2  
H 82,8 top sp.1,2

L 65

H 80 top sp.4  
H 81 top sp.3  
H 81,6 top sp.2,4  
H 82 top sp.2  
H 82,8 top sp.1,2

L 90

H 80 top sp.4  
H 81 top sp.3  
H 81,6 top sp.2,4  
H 82 top sp.2  
H 82,8 top sp.1,2

L 120

H 80 top sp.4  
H 81 top sp.3  
H 81,6 top sp.2,4  
H 82 top sp.2  
H 82,8 top sp.1,2

## TYPE C2

L 60

H 80 worktop th.4  
H 81 worktop th.3  
H 81,6 worktop th.2,4  
H 82 worktop th.2  
H 82,8 worktop th.1,2

L 60

H 80 worktop th.4  
H 81 worktop th.3  
H 81,6 worktop th.2,4  
H 82 worktop th.2  
H 82,8 worktop th.1,2

L 90

H 80 worktop th.4  
H 81 worktop th.3  
H 81,6 worktop th.2,4  
H 82 worktop th.2  
H 82,8 worktop th.1,2

L 120

H 80 worktop th.4  
H 81 worktop th.3  
H 81,6 worktop th.2,4  
H 82 worktop th.2  
H 82,8 worktop th.1,2

**CODICE**  
CODE No.

**ACCIAIO**  
STEEL

**TITANIO**  
TITANIUM

**BRUNITO**  
BURNISHED

086MC5160  
086MC5360  
086MC5560  
086MC5760  
086MC5960

086MC5165  
086MC5365  
086MC5565  
086MC5765  
086MC5965

086MC5190  
086MC5390  
086MC5590  
086MC5790  
086MC5990

086MC5195  
086MC5395  
086MC5595  
086MC5795  
086MC5995

086MC6160  
086MC6360  
086MC6560  
086MC6760  
086MC6960

086MC6165  
086MC6365  
086MC6565  
086MC6765  
086MC6965

086MC6190  
086MC6390  
086MC6590  
086MC6790  
086MC6990

086MC6195  
086MC6395  
086MC6595  
086MC6795  
086MC6995

SCHIENALI FENIX

FENIX BACK PANELS

SCHIENALI EFFETTO MARMO

EFFECT MARBLE BACK PANELS

SCHIENALI IMPIALLACCIATI WOOD

WOOD VENEERED BACK PANELS

## Finiture "MODULAR"

"MODULAR" finishes



Acciaio (opz.A)  
Stainless Steel



Titanio (opz.T)  
Titanium



Brunito (opz.B)  
Burnished

# MODULAR CON SCHIENALE

MODULAR WITH BACK PANEL

Modulo cm 60-90-120 P 15,3  
in appoggio con cielo e 2 ripiani.

Lean on rack element  
cm 60-90-120 D 15,3  
with top panel and 2 shelves.

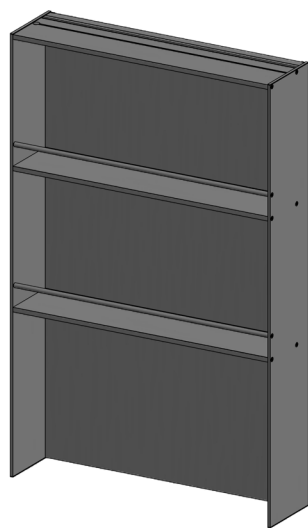

SCHIENALI FENIX  
FENIX BACK PANELS

SCHIENALI EFFETTO MARMO  
EFFECT MARBLE BACK PANELS

SCHIENALI IMPIALLACCIATI WOOD

WOOD VENEERED BACK PANELS

## TIPO D1

L 60

H 89 top sp.4  
H 90 top sp.3  
H 90,6 top sp.2,4  
H 91 top sp.2  
H 91,8 top sp.1,2

L 65

H 89 top sp.4  
H 90 top sp.3  
H 90,6 top sp.2,4  
H 91 top sp.2  
H 91,8 top sp.1,2

L 90

H 89 top sp.4  
H 90 top sp.3  
H 90,6 top sp.2,4  
H 91 top sp.2  
H 91,8 top sp.1,2

L 120

H 89 top sp.4  
H 90 top sp.3  
H 90,6 top sp.2,4  
H 91 top sp.2  
H 91,8 top sp.1,2

## TIPO D2

L 60

H 92 top sp.4  
H 93 top sp.3  
H 93,6 top sp.2,4  
H 94 top sp.2  
H 94,8 top sp.1,2

L 65

H 92 top sp.4  
H 93 top sp.3  
H 93,6 top sp.2,4  
H 94 top sp.2  
H 94,8 top sp.1,2

L 90

H 92 top sp.4  
H 93 top sp.3  
H 93,6 top sp.2,4  
H 94 top sp.2  
H 94,8 top sp.1,2

L 120

H 92 top sp.4  
H 93 top sp.3  
H 93,6 top sp.2,4  
H 94 top sp.2  
H 94,8 top sp.1,2

## TYPE D1

L 60

H 89 worktop th.4  
H 90 worktop th.3  
H 90,6 worktop th.2,4  
H 91 worktop th.2  
H 91,8 worktop th.1,2

L 65

H 89 worktop th.4  
H 90 worktop th.3  
H 90,6 worktop th.2,4  
H 91 worktop th.2  
H 91,8 worktop th.1,2

L 90

H 89 worktop th.4  
H 90 worktop th.3  
H 90,6 worktop th.2,4  
H 91 worktop th.2  
H 91,8 worktop th.1,2

L 120

H 89 worktop th.4  
H 90 worktop th.3  
H 90,6 worktop th.2,4  
H 91 worktop th.2  
H 91,8 worktop th.1,2

## TYPE D2

L 60

H 92 worktop th.4  
H 93 worktop th.3  
H 93,6 worktop th.2,4  
H 94 worktop th.2  
H 94,8 worktop th.1,2

L 65

H 92 worktop th.4  
H 93 worktop th.3  
H 93,6 worktop th.2,4  
H 94 worktop th.2  
H 94,8 worktop th.1,2

L 90

H 92 worktop th.4  
H 93 worktop th.3  
H 93,6 worktop th.2,4  
H 94 worktop th.2  
H 94,8 worktop th.1,2

L 120

H 92 worktop th.4  
H 93 worktop th.3  
H 93,6 worktop th.2,4  
H 94 worktop th.2  
H 94,8 worktop th.1,2

**CODICE**  
CODE No.

**ACCIAIO**  
STEEL

**TITANIO**  
TITANIUM

**BRUNITO**  
BURNISHED

086MD1160  
086MD1360  
086MD1560  
086MD1760  
086MD1960

086MD1165  
086MD1365  
086MD1565  
086MD1765  
086MD1965

086MD1190  
086MD1390  
086MD1590  
086MD1790  
086MD1990

086MD1195  
086MD1395  
086MD1595  
086MD1795  
086MD1995

086MD2160  
086MD2360  
086MD2560  
086MD2760  
086MD2960

086MD2165  
086MD2365  
086MD2565  
086MD2765  
086MD2965

086MD2190  
086MD2390  
086MD2590  
086MD2790  
086MD2990

086MD2195  
086MD2395  
086MD2595  
086MD2795  
086MD2995

## Finiture "MODULAR"

"MODULAR" finishes



Acciaio (opz.A)  
Stainless Steel



Titanio (opz.T)  
Titanium



Brunito (opz.B)  
Burnished

# MODULAR CON SCHIENALE

## MODULAR WITH BACK PANEL

**Modulo cm 60-90-120 P 15,3**  
in appoggio con cielo e 2 ripiani.

Lean on rack element  
cm 60-90-120 D 15,3  
with top panel and 2 shelves.

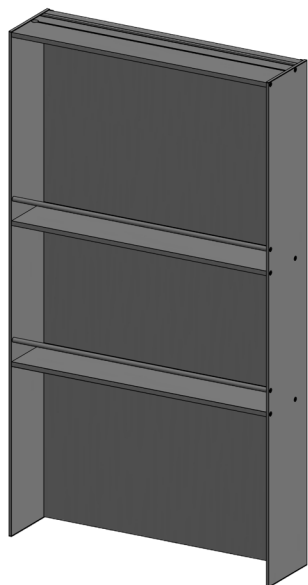

### TIPO E1

L 60

H 101 top sp.4  
H 102 top sp.3  
H 102,6 top sp.2,4  
H 103 top sp.2  
H 103,8 top sp.1,2

L 65

H 101 top sp.4  
H 102 top sp.3  
H 102,6 top sp.2,4  
H 103 top sp.2  
H 103,8 top sp.1,2

L 90

H 101 top sp.4  
H 102 top sp.3  
H 102,6 top sp.2,4  
H 103 top sp.2  
H 103,8 top sp.1,2

L 120

H 101 top sp.4  
H 102 top sp.3  
H 102,6 top sp.2,4  
H 103 top sp.2  
H 103,8 top sp.1,2

### TYPE E1

L 60

H 101 worktop th.4  
H 102 worktop th.3  
H 102,6 worktop th.2,4  
H 103 worktop th.2  
H 103,8 worktop th.1,2

L 65

H 101 worktop th.4  
H 102 worktop th.3  
H 102,6 worktop th.2,4  
H 103 worktop th.2  
H 103,8 worktop th.1,2

L 90

H 101 worktop th.4  
H 102 worktop th.3  
H 102,6 worktop th.2,4  
H 103 worktop th.2  
H 103,8 worktop th.1,2

L 120

H 101 worktop th.4  
H 102 worktop th.3  
H 102,6 worktop th.2,4  
H 103 worktop th.2  
H 103,8 worktop th.1,2

**CODICE**  
*CODE No.*

**ACCIAIO**  
STEEL

**TITANIO**  
TITANIUM

**BRUNITO**  
BURNISHED

086MD3160  
086MD3360  
086MD3560  
086MD3760  
086MD3960

086MD3165  
086MD3365  
086MD3565  
086MD3765  
086MD3965

086MD3190  
086MD3390  
086MD3590  
086MD3790  
086MD3990

086MD3195  
086MD3395  
086MD3595  
086MD3795  
086MD3995

SCHIENALI FENIX  
FENIX BACK PANELS

SCHIENALI EFFETTO MARMO  
EFFECT MARBLE BACK PANELS

SCHIENALI IMPIALLACCIATI WOOD  
WOOD VENEERED BACK PANELS

### TIPO E2

L 60

H 104 top sp.4  
H 105 top sp.3  
H 105,6 top sp.2,4  
H 106 top sp.2  
H 106,8 top sp.1,2

L 65

H 104 top sp.4  
H 105 top sp.3  
H 105,6 top sp.2,4  
H 106 top sp.2  
H 106,8 top sp.1,2

L 90

H 104 top sp.4  
H 105 top sp.3  
H 105,6 top sp.2,4  
H 106 top sp.2  
H 106,8 top sp.1,2

L 120

H 104 top sp.4  
H 105 top sp.3  
H 105,6 top sp.2,4  
H 106 top sp.2  
H 106,8 top sp.1,2

### TYPE E2

L 60

H 104 worktop th.4  
H 105 worktop th.3  
H 105,6 worktop th.2,4  
H 106 worktop th.2  
H 106,8 worktop th.1,2

L 65

H 104 worktop th.4  
H 105 worktop th.3  
H 105,6 worktop th.2,4  
H 106 worktop th.2  
H 106,8 worktop th.1,2

L 90

H 104 worktop th.4  
H 105 worktop th.3  
H 105,6 worktop th.2,4  
H 106 worktop th.2  
H 106,8 worktop th.1,2

L 120

H 104 worktop th.4  
H 105 worktop th.3  
H 105,6 worktop th.2,4  
H 106 worktop th.2  
H 106,8 worktop th.1,2

086MD4160  
086MD4360  
086MD4560  
086MD4760  
086MD4960

086MD4165  
086MD4365  
086MD4565  
086MD4765  
086MD4965

086MD4190  
086MD4390  
086MD4590  
086MD4790  
086MD4990

086MD4195  
086MD4395  
086MD4595  
086MD4795  
086MD4995



# MODULAR CON SCHIENALE

MODULAR WITH BACK PANEL

**Modulo cm 60-90 P 15,3**  
in appoggio con cielo e 3 ripiani.

Lean on rack element  
cm 60-90 D 15,3  
with top panel and 3 shelves.

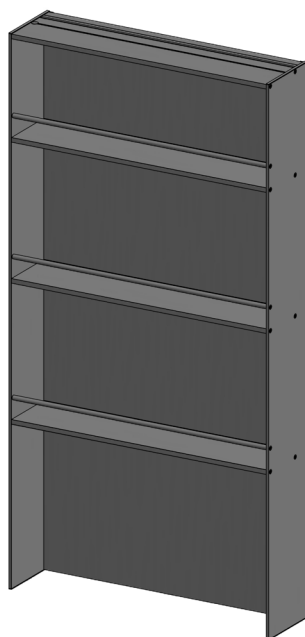

## TIPO F1

L 60

H 125 top sp.4  
H 126 top sp.3  
H 126,6 top sp.2,4  
H 127 top sp.2  
H 127,8 top sp.1,2

L 65

H 125 top sp.4  
H 126 top sp.3  
H 126,6 top sp.2,4  
H 127 top sp.2  
H 127,8 top sp.1,2

L 90

H 125 top sp.4  
H 126 top sp.3  
H 126,6 top sp.2,4  
H 127 top sp.2  
H 127,8 top sp.1,2

## TYPE F1

L 60

H 125 worktop th.4  
H 126 worktop th.3  
H 126,6 worktop th.2,4  
H 127 worktop th.2  
H 127,8 worktop th.1,2

L 65

H 125 worktop th.4  
H 126 worktop th.3  
H 126,6 worktop th.2,4  
H 127 worktop th.2  
H 127,8 worktop th.1,2

L 90

H 125 worktop th.4  
H 126 worktop th.3  
H 126,6 worktop th.2,4  
H 127 worktop th.2  
H 127,8 worktop th.1,2

## TIPO F2

L 60

H 128 top sp.4  
H 129 top sp.3  
H 129,6 top sp.2,4  
H 130 top sp.2  
H 130,8 top sp.1,2

L 65

H 128 top sp.4  
H 129 top sp.3  
H 129,6 top sp.2,4  
H 130 top sp.2  
H 130,8 top sp.1,2

L 90

H 128 top sp.4  
H 129 top sp.3  
H 129,6 top sp.2,4  
H 130 top sp.2  
H 130,8 top sp.1,2

## TYPE F2

L 60

H 128 worktop th.4  
H 129 worktop th.3  
H 129,6 worktop th.2,4  
H 130 worktop th.2  
H 130,8 worktop th.1,2

L 65

H 128 worktop th.4  
H 129 worktop th.3  
H 129,6 worktop th.2,4  
H 130 worktop th.2  
H 130,8 worktop th.1,2

L 90

H 128 worktop th.4  
H 129 worktop th.3  
H 129,6 worktop th.2,4  
H 130 worktop th.2  
H 130,8 worktop th.1,2

**CODICE**  
CODE No.

**ACCIAIO**  
STEEL

**TITANIO**  
TITANIUM

**BRUNITO**  
BURNISHED

086MC7160  
086MC7360  
086MC7560  
086MC7760  
086MC7960

086MC7165  
086MC7365  
086MC7565  
086MC7765  
086MC7965

086MC7190  
086MC7390  
086MC7590  
086MC7790  
086MC7990

086MC8160  
086MC8360  
086MC8560  
086MC8760  
086MC8960

086MC8165  
086MC8365  
086MC8565  
086MC8765  
086MC8965

086MC8190  
086MC8390  
086MC8590  
086MC8790  
086MC8990

SCHIENALI FENIX  
FENIX BACK PANELS

SCHIENALI EFFETTO MARMO  
EFFECT MARBLE BACK PANELS

SCHIENALI IMPIALLACCIATI WOOD  
WOOD VENEERED BACK PANELS

## Finiture "MODULAR"

"MODULAR" finishes



**Acciaio (opz.A)**  
Stainless Steel



**Titanio (opz.T)**  
Titanium



**Brunito (opz.B)**  
Burnished

# MODULAR SOSPESO CON SCHIENALE

MODULAR SUSPENDED WITH BACK PANEL

**Modulo H 132 P 15,3**  
sospeso con cielo e 4 ripiani.

Hanging rack element  
H 132 D 15,3  
with top panel and 4 shelves.

**CODICE**  
*CODE No.*

**ACCIAIO**  
STEEL

**TITANIO**  
TITANIUM

**BRUNITO**  
BURNISHED

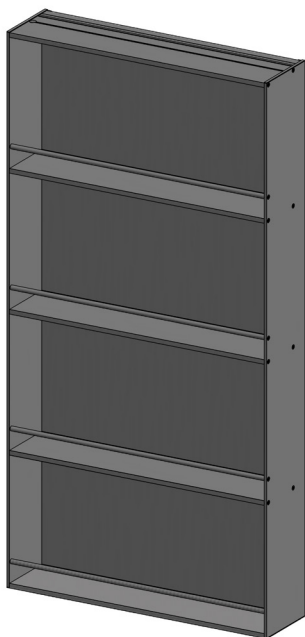

SCHIENALI FENIX  
FENIX BACK PANELS

SCHIENALI EFFETTO MARMO  
EFFECT MARBLE BACK PANELS

SCHIENALI IMPIALLACCIATI WOOD  
WOOD VENEERED BACK PANELS

L 60  
L 90

W 60  
W 90

**086MD9060**  
**086MD9090**

## Finiture "MODULAR"

"MODULAR" finishes



**Acciaio (opz.A)**  
Stainless Steel



**Titanio (opz.T)**  
Titanium



**Brunito (opz.B)**  
Burnished

# MODULAR SCHIENALI CON LUCE DUAL COLOR

MODULAR BACK PANELS WITH DUAL COLOR LIGHT



# MODULAR COLORI SCHIENALI

MODULAR COLOURS BACK PANELS

## COLORI MELAMICI MODELLO IMMAGINA PLUS

IMMAGINA PLUS MODEL MELAMINE COLOURS

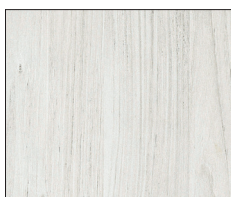

**cansiglio bianco**  
(opz.1561)  
white cansiglio

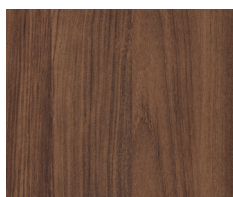

**cansiglio terra bruciata**  
(opz.1562)  
scorched earth cansiglio



**cansiglio grigio fumo**  
(opz.1563)  
smoke grey cansiglio



**cansiglio sabbia**  
(opz.1564)  
sand cansiglio



**cansiglio champagne**  
(opz.1565)  
champagne cansiglio



**larice baglia**  
(opz.1826)  
baglia larch

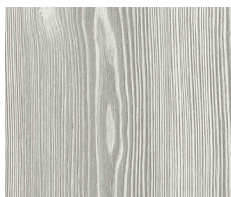

**larice laguna**  
(opz.1827)  
lagoon larch

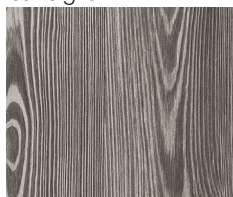

**larice vulcano**  
(opz.1828)  
volcano larch



**larice terra**  
(opz.1829)  
earth larch

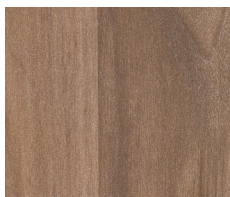

**noce**  
(opz.2363)  
walnut



**cemento**  
(opz.9633)  
cement



**bianco cristallo**  
(opz.7445)  
cristal white



**grigio nebbia**  
(opz.9626)  
fog grey



**castoro**  
(opz.8862)  
beaver

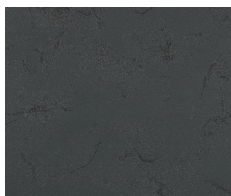

**lavagna**  
(opz.9627)  
slate grey



**juta**  
(opz.8863)  
jute

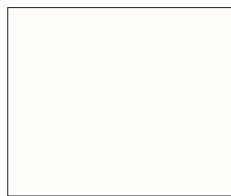

**bianco assoluto**  
(opz.7441)  
absolute white

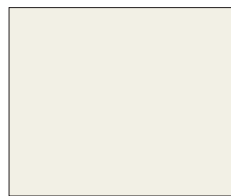

**bianco neve**  
(opz.7450)  
snow white



**grigio sasso**  
(opz.9650)  
pebble grey



**verde marino**  
(opz.8402)  
sea green



**grigio monzone**  
(opz.9651)  
monsoon grey



**grigio notte**  
(opz.9652)  
midnight grey



**grigio velo**  
(opz.9653)  
veil grey

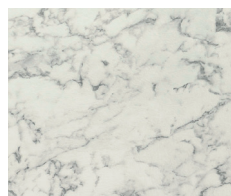

**marmo baron**  
(opz.9632)  
baron marble



**nicel**  
(opz.9660)  
nickel

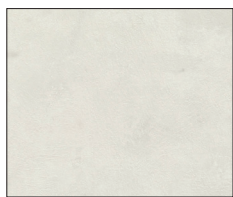

**platino**  
(opz.9661)  
platinum



**zinco**  
(opz.9662)  
zinc



**peltro**  
(opz.9666)  
pewter



**titanio**  
(opz.9665)  
titanium



**olmo bianco**  
(opz.5001)  
white elm



**olmo antracite**  
(opz.5004)  
anthracite elm

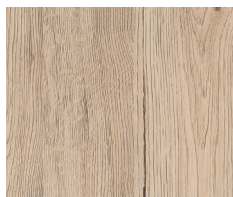

**oak miele**  
(opz.1361)  
honey oak



**oak neve**  
(opz.1362)  
snow oak



**oak cognac**  
(opz.1363)  
cognac oak

# MODULAR COLORI SCHIENALI

MODULAR COLOURS BACK PANELS

## COLORI MELAMICI MODELLO TABLET - JEY FEEL - SMART

TABLET - JEY FEEL - SMART MODEL MELAMINE COLOURS



**rovere luna**  
(opz.5316)  
moon oak

**rovere venere**  
(opz.5315)  
venus oak

**rovere arizona**  
(opz.5317)  
arizona oak

**rovere dark**  
(opz.5318)  
dark oak

**frassino lava**  
(opz.2408)  
lava ash

**frassino sabbia**  
(opz.2406)  
sand ash

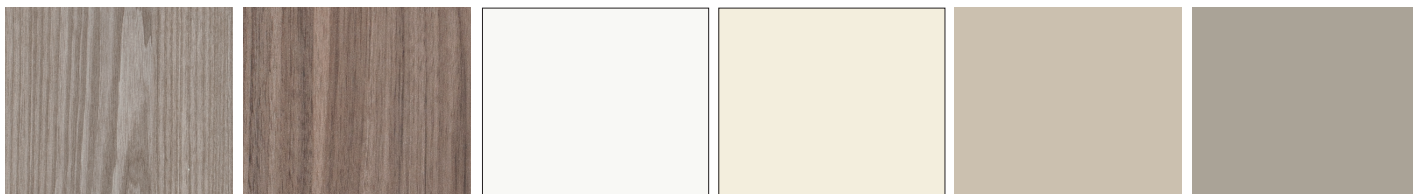

**frassino pietra**  
(opz.2407)  
stone ash

**noce brown**  
(opz.2371)  
brown walnut

**bianco soft matt**  
(opz.7447N)  
soft matt white

**porcellana soft matt**  
(opz.7703N)  
soft matt porcelain

**desert soft matt**  
(opz.8914N)  
soft matt desert

**molaria soft matt**  
(opz.9636N)  
soft matt molaria



**arena soft matt** (opz.9637N)  
soft matt arena

**bianco**  
(opz.9639)  
white

**bronzo**  
(opz.8866)  
bronze

**ardesia**  
(opz.9638)  
slate grey

**rovere silver**  
(opz.5306)  
silver oak

**rovere diamond**  
(opz.5307)  
diamond oak



**rovere tabià**  
(opz.5309)  
tabià oak

**rovere ortisei**  
(opz.5305)  
ortisei oak

**trani**  
(opz.7704)  
trani

**black**  
(opz.7863)  
black

**white**  
(opz.7448)  
white

**grigio agata**  
(opz.9623)  
agata grey

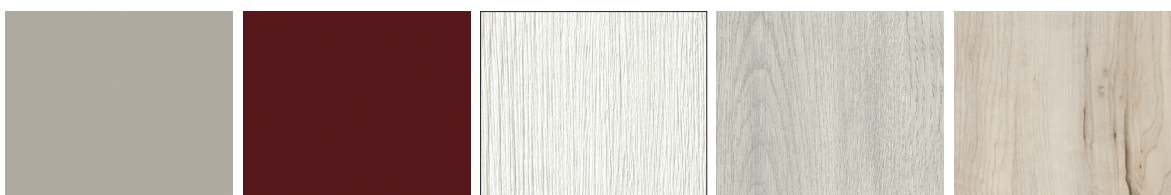

**grigio inox**  
(opz.9624)  
stainless steel grey

**rosso cardinale**  
(opz.8123)  
cardinal red

**frassino bianco alpino**  
(opz.2310)  
alpine-white ash

**rovere greige**  
(opz.2320)  
greige oak

**betulla**  
(opz.2311)  
birch

## COLORI STRUTTURE

CARCASSES COLOURS



**bianco** (opz.001)  
white

**visone** (opz.948M)  
mink

**lavagna** (opz.9620)  
slate grey

**fango** (opz.8860)  
mud

**conchiglia** (opz.8910)  
shell

**argilla** (opz.9690)  
clay



# MODULAR COLORI SCHIENALI

MODULAR COLOURS BACK PANELS

## COLORI FENIX

FENIX COLOURS

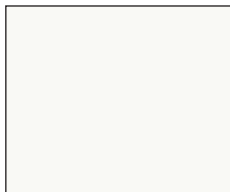

**bianco caldo**  
(opz.0032)  
warm white

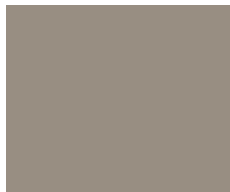

**castoro**  
(opz.0717)  
beaver

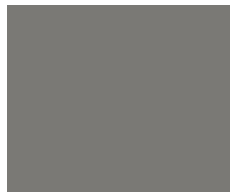

**fumo**  
(opz.0718)  
smoke



**nero**  
(opz.0720)  
black

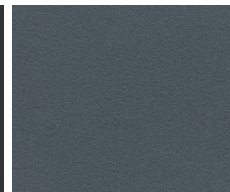

**grigio bromo**  
(opz.0724)  
bromine grey

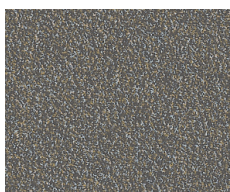

**bronzo doha**  
(opz.2629)  
doha bronze



**beige arizona**  
(opz.0748)  
arizona beige



**cacao orinoco**  
(opz.0749)  
orinoco cocoa



**rosso jaipur**  
(opz.0751)  
jaipur red



**verde commodoro**  
(opz.0750)  
commodoro green



**grigio antrim**  
(opz.0752)  
antrim grey

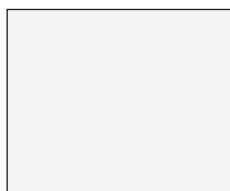

**bianco dover**  
(opz.0757)  
dover white



**grigio efeso**  
(opz.0725)  
ephesus grey

## COLORI EFFETTO MARMO

MARBLE EFFECT COLOURS

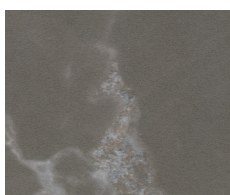

**perlato finitura ker**  
(opz.3443)  
pearly with ker finish

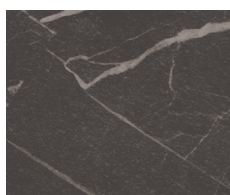

**alabastro finitura mn**  
(opz.6014)  
alabaster with mn finish



**calacatta finitura mn**  
(opz.6019)  
calacatta with mn finish

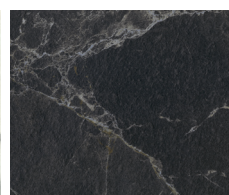

**dark finitura mn**  
(opz.6133)  
dark with mn finish

## COLORI WOOD IMPIALLACCIATO MODELLO IMMAGINA - TABLET

IMMAGINA - TABLET MODEL VENEERED COLOURS

**N.B: non utilizzati per gli elementi da 120**

**Note: not used for 120 elements**

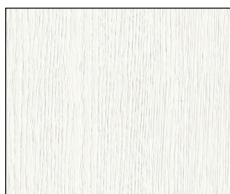

**rovere bianco**  
(opz.5441)  
white oak

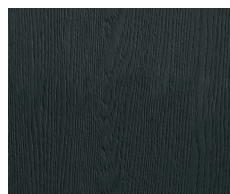

**rovere nero**  
(opz.5446)  
black oak

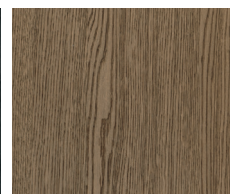

**rovere moscato**  
(opz.5444)  
muscat oak

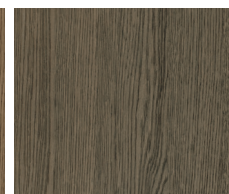

**rovere fumè**  
(opz.5445)  
smoked oak

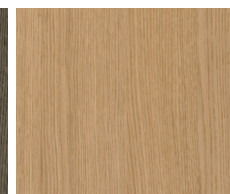

**rovere naturale**  
(opz.5442)  
natural oak

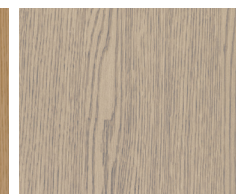

**rovere grey**  
(opz.5443)  
grey oak

# MODULAR CON SCHIENALE E LUCE DUAL COLOR

MODULAR WITH BACK PANEL AND DUAL COLOR LIGHT

**Modulo cm 60-90-120 P 15,2  
in appoggio con cielo e ripiano.**  
**N.B.: kit dual color incluso**

Lean on rack element  
cm 60-90-120 D 15,2  
with top panel and shelf.  
**Note: kit dual colours  
included**

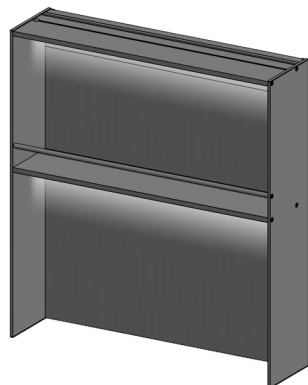

SCHIENALI FENIX

FENIX BACK PANELS

SCHIENALI EFFETTO MARMO

EFFECT MARBLE BACK PANELS

SCHIENALI IMPIALLACCIATI WOOD

WOOD VENEERED BACK PANELS

**N.B.: inserire l'alimentatore corretto in base  
all'assorbimento totale dato dalla somma degli elementi  
inseriti nella composizione.**  
**Vedi pagina 31**

**Note: insert the correct power supply in the base  
to the total absorption given by the sum of the elements  
included in the composition.**  
**See page 31**

## TIPO B1

### L 60 W14 Totali

H 65 top sp.4  
H 66 top sp.3  
H 66,6 top sp.2,4  
H 67 top sp.2  
H 67,8 top sp.1,2

### L 65 W16 Totali

H 65 top sp.4  
H 66 top sp.3  
H 66,6 top sp.2,4  
H 67 top sp.2  
H 67,8 top sp.1,2

### L 90 W20 Totali

H 65 top sp.4  
H 66 top sp.3  
H 66,6 top sp.2,4  
H 67 top sp.2  
H 67,8 top sp.1,2

### L 120 W28 Totali

H 65 top sp.4  
H 66 top sp.3  
H 66,6 top sp.2,4  
H 67 top sp.2  
H 67,8 top sp.1,2

## TIPO B2

### L 60 W14 Totali

H 68 top sp.4  
H 69 top sp.3  
H 69,6 top sp.2,4  
H 70 top sp.2  
H 70,8 top sp.1,2

### L 65 W16 Totali

H 68 top sp.4  
H 69 top sp.3  
H 69,6 top sp.2,4  
H 70 top sp.2  
H 70,8 top sp.1,2

### L 90 W20 Totali

H 68 top sp.4  
H 69 top sp.3  
H 69,6 top sp.2,4  
H 70 top sp.2  
H 70,8 top sp.1,2

### L 120 W28 Totali

H 68 top sp.4  
H 69 top sp.3  
H 69,6 top sp.2,4  
H 70 top sp.2  
H 70,8 top sp.1,2

## TYPE B1

### L 60 W14 Total

H 65 worktop th.4  
H 66 worktop th.3  
H 66,6 worktop th.2,4  
H 67 worktop th.2  
H 67,8 worktop th.1,2

### L 65 W16 Total

H 65 worktop th.4  
H 66 worktop th.3  
H 66,6 worktop th.2,4  
H 67 worktop th.2  
H 67,8 worktop th.1,2

### L 90 W20 Total

H 65 worktop th.4  
H 66 worktop th.3  
H 66,6 worktop th.2,4  
H 67 worktop th.2  
H 67,8 worktop th.1,2

### L 120 W28 Total

H 65 worktop th.4  
H 66 worktop th.3  
H 66,6 worktop th.2,4  
H 67 worktop th.2  
H 67,8 worktop th.1,2

## TYPE B2

### L 60 W14 Total

H 68 worktop th.4  
H 69 worktop th.3  
H 69,6 worktop th.2,4  
H 70 worktop th.2  
H 70,8 worktop th.1,2

### L 65 W16 Total

H 68 worktop th.4  
H 69 worktop th.3  
H 69,6 worktop th.2,4  
H 70 worktop th.2  
H 70,8 worktop th.1,2

### L 90 W20 Total

H 68 worktop th.4  
H 69 worktop th.3  
H 69,6 worktop th.2,4  
H 70 worktop th.2  
H 70,8 worktop th.1,2

### L 120 W28 Total

H 68 worktop th.4  
H 69 worktop th.3  
H 69,6 worktop th.2,4  
H 70 worktop th.2  
H 70,8 worktop th.1,2

**CODICE  
CODE No.**

**ACCIAIO**  
STEEL

**TITANIO**  
TITANIUM

**BRUNITO**  
BURNISHED

**086MCL3160**  
**086MCL3360**  
**086MCL3560**  
**086MCL3760**  
**086MCL3960**

**086MCL3165**  
**086MCL3365**  
**086MCL3565**  
**086MCL3765**  
**086MCL3965**

**086MCL3190**  
**086MCL3390**  
**086MCL3590**  
**086MCL3790**  
**086MCL3990**

**086MCL3195**  
**086MCL3395**  
**086MCL3595**  
**086MCL3795**  
**086MCL3995**

**086MCL4160**  
**086MCL4360**  
**086MCL4560**  
**086MCL4760**  
**086MCL4960**

**086MCL4165**  
**086MCL4365**  
**086MCL4565**  
**086MCL4765**  
**086MCL4965**

**086MCL4190**  
**086MCL4390**  
**086MCL4590**  
**086MCL4790**  
**086MCL4990**

**086MCL4195**  
**086MCL4395**  
**086MCL4595**  
**086MCL4795**  
**086MCL4995**

## Finiture "MODULAR"

"MODULAR" finishes



**Acciaio (opz.A)**  
Stainless Steel



**Titanio (opz.T)**  
Titanium



**Brunito (opz.B)**  
Burnished

# MODULAR CON SCHIENALE E LUCE DUAL COLOR

MODULAR WITH BACK PANEL AND DUAL COLOR LIGHT

**Modulo cm 60-90-120 P 15,2  
in appoggio con cielo e 2 ripiani.  
N.B.: kit dual color incluso**

Lean on rack element  
cm 60-90-120 D 15,2  
with top panel and 2 shelves.  
Note: kit dual colours  
included

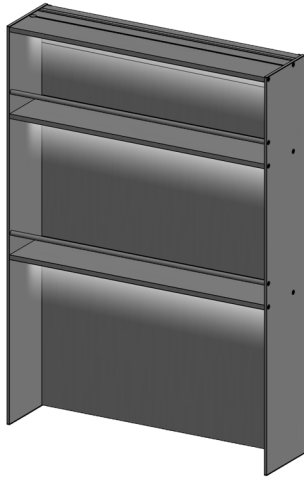

SCHIENALI FENIX

FENIX BACK PANELS

SCHIENALI EFFETTO MARMO

EFFECT MARBLE BACK PANELS

SCHIENALI IMPIALLACCIATI WOOD

WOOD VENEERED BACK PANELS

**N.B.: inserire l'alimentatore corretto in base  
all'assorbimento totale dato dalla somma degli elementi  
inseriti nella composizione.  
Vedi pagina 31**

**Note: insert the correct power supply in the base  
to the total absorption given by the sum of the elements  
included in the composition.  
See page 31**

## TIPO C1

### L 60 W21 Totali

H 77 top sp.4  
H 78 top sp.3  
H 78,6 top sp.2,4  
H 79 top sp.2  
H 79,8 top sp.1,2

### L 65 W24 Totali

H 77 top sp.4  
H 78 top sp.3  
H 78,6 top sp.2,4  
H 79 top sp.2  
H 79,8 top sp.1,2

### L 90 W30 Totali

H 77 top sp.4  
H 78 top sp.3  
H 78,6 top sp.2,4  
H 79 top sp.2  
H 79,8 top sp.1,2

### L 120 W42 Totali

H 77 top sp.4  
H 78 top sp.3  
H 78,6 top sp.2,4  
H 79 top sp.2  
H 79,8 top sp.1,2

## TIPO C2

### L 60 W21 Totali

H 80 top sp.4  
H 81 top sp.3  
H 81,6 top sp.2,4  
H 82 top sp.2  
H 82,8 top sp.1,2

### L 65 W24 Totali

H 80 top sp.4  
H 81 top sp.3  
H 81,6 top sp.2,4  
H 82 top sp.2  
H 82,8 top sp.1,2

### L 90 W30 Totali

H 80 top sp.4  
H 81 top sp.3  
H 81,6 top sp.2,4  
H 82 top sp.2  
H 82,8 top sp.1,2

### L 120 W42 Totali

H 80 top sp.4  
H 81 top sp.3  
H 81,6 top sp.2,4  
H 82 top sp.2  
H 82,8 top sp.1,2

## TYPE C1

### L 60 W21 Total

H 77 worktop th.4  
H 78 worktop th.3  
H 78,6 worktop th.2,4  
H 79 worktop th.2  
H 79,8 worktop th.1,2

### L 65 W24 Total

H 77 worktop th.4  
H 78 worktop th.3  
H 78,6 worktop th.2,4  
H 79 worktop th.2  
H 79,8 worktop th.1,2

### L 90 W30 Total

H 77 worktop th.4  
H 78 worktop th.3  
H 78,6 worktop th.2,4  
H 79 worktop th.2  
H 79,8 worktop th.1,2

### L 120 W42 Total

H 77 worktop th.4  
H 78 worktop th.3  
H 78,6 worktop th.2,4  
H 79 worktop th.2  
H 79,8 worktop th.1,2

## TYPE C2

### L 60 W21 Total

H 80 worktop th.4  
H 81 worktop th.3  
H 81,6 worktop th.2,4  
H 82 worktop th.2  
H 82,8 worktop th.1,2

### L 65 W24 Total

H 80 worktop th.4  
H 81 worktop th.3  
H 81,6 worktop th.2,4  
H 82 worktop th.2  
H 82,8 worktop th.1,2

### L 90 W30 Total

H 80 worktop th.4  
H 81 worktop th.3  
H 81,6 worktop th.2,4  
H 82 worktop th.2  
H 82,8 worktop th.1,2

### L 120 W42 Total

H 80 worktop th.4  
H 81 worktop th.3  
H 81,6 worktop th.2,4  
H 82 worktop th.2  
H 82,8 worktop th.1,2

**CODICE  
CODE No.**

**ACCIAIO**  
STEEL

**TITANIO**  
TITANIUM

**BRUNITO**  
BURNISHED

**086MCL5160  
086MCL5360  
086MCL5560  
086MCL5760  
086MCL5960**

**086MCL5165  
086MCL5365  
086MCL5565  
086MCL5765  
086MCL5965**

**086MCL5190  
086MCL5390  
086MCL5590  
086MCL5790  
086MCL5990**

**086MCL5195  
086MCL5395  
086MCL5595  
086MCL5795  
086MCL5995**

**086MCL6160  
086MCL6360  
086MCL6560  
086MCL6760  
086MCL6960**

**086MCL6165  
086MCL6365  
086MCL6565  
086MCL6765  
086MCL6965**

**086MCL6190  
086MCL6390  
086MCL6590  
086MCL6790  
086MCL6990**

**086MCL6195  
086MCL6395  
086MCL6595  
086MCL6795  
086MCL6995**

## Finiture "MODULAR"

"MODULAR" finishes



**Acciaio (opz.A)**  
Stainless Steel



**Titanio (opz.T)**  
Titanium



**Brunito (opz.B)**  
Burnished

# MODULAR CON SCHIENALE E LUCE DUAL COLOR

MODULAR WITH BACK PANEL AND DUAL COLOR LIGHT

**Modulo cm 60-90-120 P 15,2  
in appoggio con cielo e 2 ripiani.**  
**N.B.: kit dual color incluso**

Lean on rack element  
cm 60-90-120 D 15,2  
with top panel and 2 shelves.  
**Note: kit dual colours  
included**

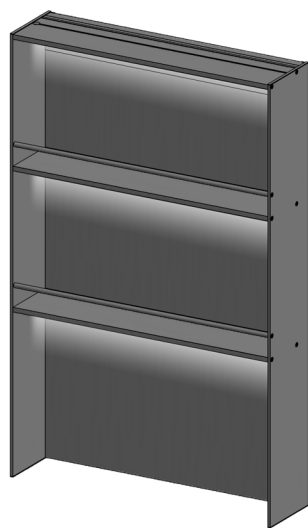

SCHIENALI FENIX  
FENIX BACK PANELS

SCHIENALI EFFETTO MARMO  
EFFECT MARBLE BACK PANELS

SCHIENALI IMPIALLACCIATI WOOD

WOOD VENEERED BACK PANELS

**N.B.: inserire l'alimentatore corretto in base  
all'assorbimento totale dato dalla somma degli elementi  
inseriti nella composizione.**  
Vedi pagina 31

**Note: insert the correct power supply in the base  
to the total absorption given by the sum of the elements  
included in the composition.**  
See page 31

## TIPO D1

**L 60 W21 Totali**  
H 89 top sp.4  
H 90 top sp.3  
H 90,6 top sp.2,4  
H 91 top sp.2  
H 91,8 top sp.1,2

**L 65 W24 Totali**  
H 89 top sp.4  
H 90 top sp.3  
H 90,6 top sp.2,4  
H 91 top sp.2  
H 91,8 top sp.1,2

**L 90 W30 Totali**  
H 89 top sp.4  
H 90 top sp.3  
H 90,6 top sp.2,4  
H 91 top sp.2  
H 91,8 top sp.1,2

**L 120 W42 Totali**  
H 89 top sp.4  
H 90 top sp.3  
H 90,6 top sp.2,4  
H 91 top sp.2  
H 91,8 top sp.1,2

## TIPO D2

**L 60 W21 Totali**  
H 92 top sp.4  
H 93 top sp.3  
H 93,6 top sp.2,4  
H 94 top sp.2  
H 94,8 top sp.1,2

**L 65 W24 Totali**  
H 92 top sp.4  
H 93 top sp.3  
H 93,6 top sp.2,4  
H 94 top sp.2  
H 94,8 top sp.1,2

**L 90 W30 Totali**  
H 92 top sp.4  
H 93 top sp.3  
H 93,6 top sp.2,4  
H 94 top sp.2  
H 94,8 top sp.1,2

**L 120 W42 Totali**  
H 92 top sp.4  
H 93 top sp.3  
H 93,6 top sp.2,4  
H 94 top sp.2  
H 94,8 top sp.1,2

## TYPE D1

**L 60 W21 Total**  
H 89 worktop th.4  
H 90 worktop th.3  
H 90,6 worktop th.2,4  
H 91 worktop th.2  
H 91,8 worktop th.1,2

**L 65 W24 Total**  
H 89 worktop th.4  
H 90 worktop th.3  
H 90,6 worktop th.2,4  
H 91 worktop th.2  
H 91,8 worktop th.1,2

**L 90 W30 Total**  
H 89 worktop th.4  
H 90 worktop th.3  
H 90,6 worktop th.2,4  
H 91 worktop th.2  
H 91,8 worktop th.1,2

**L 120 W42 Total**  
H 89 worktop th.4  
H 90 worktop th.3  
H 90,6 worktop th.2,4  
H 91 worktop th.2  
H 91,8 worktop th.1,2

## TYPE D2

**L 60 W21 Total**  
H 92 worktop th.4  
H 93 worktop th.3  
H 93,6 worktop th.2,4  
H 94 worktop th.2  
H 94,8 worktop th.1,2

**L 65 W24 Total**  
H 92 worktop th.4  
H 93 worktop th.3  
H 93,6 worktop th.2,4  
H 94 worktop th.2  
H 94,8 worktop th.1,2

**L 90 W30 Total**  
H 92 worktop th.4  
H 93 worktop th.3  
H 93,6 worktop th.2,4  
H 94 worktop th.2  
H 94,8 worktop th.1,2

**L 120 W42 Total**  
H 92 worktop th.4  
H 93 worktop th.3  
H 93,6 worktop th.2,4  
H 94 worktop th.2  
H 94,8 worktop th.1,2

**CODICE**  
**CODE No.**

**ACCIAIO**  
STEEL

**TITANIO**  
TITANIUM

**BRUNITO**  
BURNISHED

**086MDL1160**  
**086MDL1360**  
**086MDL1560**  
**086MDL1760**  
**086MDL1960**

**086MDL1165**  
**086MDL1365**  
**086MDL1565**  
**086MDL1765**  
**086MDL1965**

**086MDL1190**  
**086MDL1390**  
**086MDL1590**  
**086MDL1790**  
**086MDL1990**

**086MDL1195**  
**086MDL1395**  
**086MDL1595**  
**086MDL1795**  
**086MDL1995**

**086MDL2160**  
**086MDL2360**  
**086MDL2560**  
**086MDL2760**  
**086MDL2960**

**086MDL2165**  
**086MDL2365**  
**086MDL2565**  
**086MDL2765**  
**086MDL2965**

**086MDL2190**  
**086MDL2390**  
**086MDL2590**  
**086MDL2790**  
**086MDL2990**

**086MDL2195**  
**086MDL2395**  
**086MDL2595**  
**086MDL2795**  
**086MDL2995**

## Finiture "MODULAR"

"MODULAR" finishes



**Acciaio (opz.A)**  
Stainless Steel



**Titanio (opz.T)**  
Titanium



**Brunito (opz.B)**  
Burnished

# MODULAR CON SCHIENALE E LUCE DUAL COLOR

MODULAR WITH BACK PANEL AND DUAL COLOR LIGHT

**Modulo cm 60-90-120 P 15,2**  
**in appoggio con cielo e 2 ripiani.**  
**N.B.: kit dual color incluso**

Lean on rack element  
 cm 60-90-120 D 15,2  
 with top panel and 2 shelves.  
 Note: kit dual colours  
 included

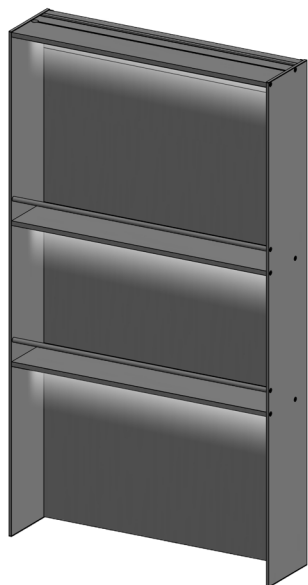

SCHIENALI FENIX  
 FENIX BACK PANELS

SCHIENALI EFFETTO MARMO  
 EFFECT MARBLE BACK PANELS

SCHIENALI IMPIALLACCIATI WOOD  
 WOOD VENEERED BACK PANELS

**N.B.: inserire l'alimentatore corretto in base**  
**all'assorbimento totale dato dalla somma degli elementi**  
**inseriti nella composizione.**  
**Vedi pagina 31**

**Note: insert the correct power supply in the base**  
**to the total absorption given by the sum of the elements**  
**included in the composition.**  
**See page 31**

## TIPO E1

**L 60 W21 Totali**  
 H 101 top sp.4  
 H 102 top sp.3  
 H 102,6 top sp.2,4  
 H 103 top sp.2  
 H 103,8 top sp.1,2

**L 65 W24 Totali**  
 H 101 top sp.4  
 H 102 top sp.3  
 H 102,6 top sp.2,4  
 H 103 top sp.2  
 H 103,8 top sp.1,2

**L 90 W30 Totali**  
 H 101 top sp.4  
 H 102 top sp.3  
 H 102,6 top sp.2,4  
 H 103 top sp.2  
 H 103,8 top sp.1,2

**L 120 W42 Totali**  
 H 101 top sp.4  
 H 102 top sp.3  
 H 102,6 top sp.2,4  
 H 103 top sp.2  
 H 103,8 top sp.1,2

## TIPO E2

**L 60 W21 Totali**  
 H 104 top sp.4  
 H 105 top sp.3  
 H 105,6 top sp.2,4  
 H 106 top sp.2  
 H 106,8 top sp.1,2

**L 65 W24 Totali**  
 H 104 top sp.4  
 H 105 top sp.3  
 H 105,6 top sp.2,4  
 H 106 top sp.2  
 H 106,8 top sp.1,2

**L 90 W30 Totali**  
 H 104 top sp.4  
 H 105 top sp.3  
 H 105,6 top sp.2,4  
 H 106 top sp.2  
 H 106,8 top sp.1,2

**L 120 W42 Totali**  
 H 104 top sp.4  
 H 105 top sp.3  
 H 105,6 top sp.2,4  
 H 106 top sp.2  
 H 106,8 top sp.1,2

## TYPE E1

**L 60 W21 Total**  
 H 101 worktop th.4  
 H 102 worktop th.3  
 H 102,6 worktop th.2,4  
 H 103 worktop th.2  
 H 103,8 worktop th.1,2

**L 65 W24 Total**  
 H 101 worktop th.4  
 H 102 worktop th.3  
 H 102,6 worktop th.2,4  
 H 103 worktop th.2  
 H 103,8 worktop th.1,2

**L 90 W30 Total**  
 H 101 worktop th.4  
 H 102 worktop th.3  
 H 102,6 worktop th.2,4  
 H 103 worktop th.2  
 H 103,8 worktop th.1,2

**L 120 W42 Total**  
 H 101 worktop th.4  
 H 102 worktop th.3  
 H 102,6 worktop th.2,4  
 H 103 worktop th.2  
 H 103,8 worktop th.1,2

## TYPE E2

**L 60 W21 Total**  
 H 104 worktop th.4  
 H 105 worktop th.3  
 H 105,6 worktop th.2,4  
 H 106 worktop th.2  
 H 106,8 worktop th.1,2

**L 65 W24 Total**  
 H 104 worktop th.4  
 H 105 worktop th.3  
 H 105,6 worktop th.2,4  
 H 106 worktop th.2  
 H 106,8 worktop th.1,2

**L 90 W30 Total**  
 H 104 worktop th.4  
 H 105 worktop th.3  
 H 105,6 worktop th.2,4  
 H 106 worktop th.2  
 H 106,8 worktop th.1,2

**L 120 W42 Total**  
 H 104 worktop th.4  
 H 105 worktop th.3  
 H 105,6 worktop th.2,4  
 H 106 worktop th.2  
 H 106,8 worktop th.1,2

**CODICE**  
**CODE No.**

**ACCIAIO**  
 STEEL

**TITANIO**  
 TITANIUM

**BRUNITO**  
 BURNISHED

**086MDL3160**  
**086MDL3360**  
**086MDL3560**  
**086MDL3760**  
**086MDL3960**

**086MDL3165**  
**086MDL3365**  
**086MDL3565**  
**086MDL3765**  
**086MDL3965**

**086MDL3190**  
**086MDL3390**  
**086MDL3590**  
**086MDL3790**  
**086MDL3990**

**086MDL3195**  
**086MDL3395**  
**086MDL3595**  
**086MDL3795**  
**086MDL3995**

**086MDL4160**  
**086MDL4360**  
**086MDL4560**  
**086MDL4760**  
**086MDL4960**

**086MDL4165**  
**086MDL4365**  
**086MDL4565**  
**086MDL4765**  
**086MDL4965**

**086MDL4190**  
**086MDL4390**  
**086MDL4590**  
**086MDL4790**  
**086MDL4990**

**086MDL4195**  
**086MDL4395**  
**086MDL4595**  
**086MDL4795**  
**086MDL4995**



# MODULAR CON SCHIENALE E LUCE DUAL COLOR

MODULAR WITH BACK PANEL AND DUAL COLOR LIGHT

**Modulo cm 60-90 P 15,2  
in appoggio con cielo e 3 ripiani.  
N.B.: kit dual color incluso**

Lean on rack element  
cm 60-90 D 15,2  
with top panel and 3 shelves.  
Note: kit dual colours  
included

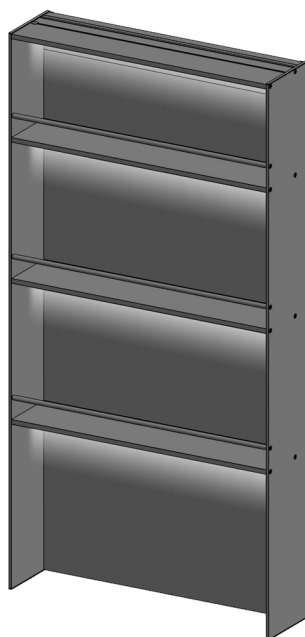

## TIPO F1

**L 60 W28 Totali**  
H 125 top sp.4  
H 126 top sp.3  
H 126,6 top sp.2,4  
H 127 top sp.2  
H 127,8 top sp.1,2

**L 65 W32 Totali**  
H 125 top sp.4  
H 126 top sp.3  
H 126,6 top sp.2,4  
H 127 top sp.2  
H 127,8 top sp.1,2

**L 90 W40 Totali**  
H 125 top sp.4  
H 126 top sp.3  
H 126,6 top sp.2,4  
H 127 top sp.2  
H 127,8 top sp.1,2

## TYPE F1

**L 60 W28 Total**  
H 125 worktop th.4  
H 126 worktop th.3  
H 126,6 worktop th.2,4  
H 127 worktop th.2  
H 127,8 worktop th.1,2

**L 65 W32 Total**  
H 125 worktop th.4  
H 126 worktop th.3  
H 126,6 worktop th.2,4  
H 127 worktop th.2  
H 127,8 worktop th.1,2

**L 90 W40 Total**  
H 125 worktop th.4  
H 126 worktop th.3  
H 126,6 worktop th.2,4  
H 127 worktop th.2  
H 127,8 worktop th.1,2

**CODICE**  
*CODE No.*

**ACCIAIO**  
STEEL

**TITANIO**  
TITANIUM

**BRUNITO**  
BURNISHED

**086MCL7160**  
**086MCL7360**  
**086MCL7560**  
**086MCL7760**  
**086MCL7960**

**086MCL7165**  
**086MCL7365**  
**086MCL7565**  
**086MCL7765**  
**086MCL7965**

**086MCL7190**  
**086MCL7390**  
**086MCL7590**  
**086MCL7790**  
**086MCL7990**

## TIPO F2

**L 60 W28 Totali**  
H 128 top sp.4  
H 129 top sp.3  
H 129,6 top sp.2,4  
H 130 top sp.2  
H 130,8 top sp.1,2

**L 65 W32 Totali**  
H 128 top sp.4  
H 129 top sp.3  
H 129,6 top sp.2,4  
H 130 top sp.2  
H 130,8 top sp.1,2

**L 90 W40 Totali**  
H 128 top sp.4  
H 129 top sp.3  
H 129,6 top sp.2,4  
H 130 top sp.2  
H 130,8 top sp.1,2

## TYPE F2

**L 60 W28 Total**  
H 128 worktop th.4  
H 129 worktop th.3  
H 129,6 worktop th.2,4  
H 130 worktop th.2  
H 130,8 worktop th.1,2

**L 65 W32 Total**  
H 128 worktop th.4  
H 129 worktop th.3  
H 129,6 worktop th.2,4  
H 130 worktop th.2  
H 130,8 worktop th.1,2

**L 90 W40 Total**  
H 128 worktop th.4  
H 129 worktop th.3  
H 129,6 worktop th.2,4  
H 130 worktop th.2  
H 130,8 worktop th.1,2

**086MCL8160**  
**086MCL8360**  
**086MCL8560**  
**086MCL8760**  
**086MCL8960**

**086MCL8165**  
**086MCL8365**  
**086MCL8565**  
**086MCL8765**  
**086MCL8965**

**086MCL8190**  
**086MCL8390**  
**086MCL8590**  
**086MCL8790**  
**086MCL8990**

SCHIENALI FENIX

FENIX BACK PANELS

SCHIENALI EFFETTO MARMO

EFFECT MARBLE BACK PANELS

SCHIENALI IMPIALLACCIATI WOOD

WOOD VENEERED BACK PANELS

**N.B.: inserire l'alimentatore corretto in base  
all'assorbimento totale dato dalla somma degli elementi  
inseriti nella composizione.  
Vedi pagina 31**

**Note: insert the correct power supply in the base  
to the total absorption given by the sum of the elements  
included in the composition.  
See page 31**

## Finiture "MODULAR"

"MODULAR" finishes

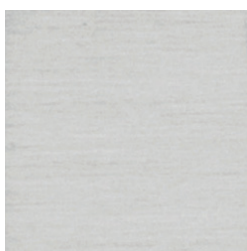

**Acciaio (opz.A)**  
Stainless Steel



**Titanio (opz.T)**  
Titanium



**Brunito (opz.B)**  
Burnished

# MODULAR CON SCHIENALE E LUCE DUAL COLOR

MODULAR WITH BACK PANEL AND DUAL COLOR LIGHT

**Modulo H 132 P 15,2**  
**sospeso con cielo e 4 ripiani.**  
**N.B.: kit dual color incluso**

Hanging rack element  
 H 132 D 15,2  
 with top panel and 4 shelves.  
 Note: kit dual colours  
 included

**CODICE**  
**CODE No.**

**ACCIAIO**  
 STEEL

**TITANIO**  
 TITANIUM

**BRUNITO**  
 BURNISHED

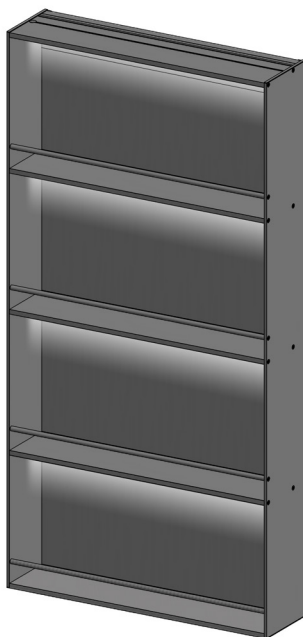

SCHIENALI FENIX  
 FENIX BACK PANELS

SCHIENALI EFFETTO MARMO  
 EFFECT MARBLE BACK PANELS

SCHIENALI IMPIALLACCIATI WOOD  
 WOOD VENEERED BACK PANELS

N.B.: inserire l'alimentatore corretto in base  
 all'assorbimento totale dato dalla somma degli elementi  
 inseriti nella composizione.  
 Vedi pagina 31

Note: insert the correct power supply in the base  
 to the total absorption given by the sum of the elements  
 included in the composition.  
 See page 31

**L 60 W28 Totali**  
**L 90 W40 Totali**

W 60 W28 Total  
 W 90 W40 Total

**086MDL9060**  
**086MDL9090**

## Finiture "MODULAR"

"MODULAR" finishes



**Acciaio (opz.A)**  
 Stainless Steel



**Titanio (opz.T)**  
 Titanium



**Brunito (opz.B)**  
 Burnished

# DIMMER CON RADIOCOMANDO 4 ZONE

## DIMMER WITH WIRELESS 4-ZONE CONTROL



### RICEVITORE DIMMER

Dimensioni 145 x 46,5 x 16 mm

Questo ricevitore 24Vdc deve essere collegato al trasformatore e comanda fino a 6 barre LED fino a max 180 Watt di assorbimento. Fare riferimento ai Watt dei LED indicati in tabella.

### DIMMER RECEIVER

Dimensions 145 x 46,5 x 16 mm

This 24Vdc device has to be connected to the power supply and can control up to 6 LED lights for a max power consumption of 180 Watt. Please refer to the Watt of each LED light in the table.

### RADIOCOMANDO WIRELESS 4-ZONE (da abbinare a ricevitore dimmer)

Dimensioni 137 x 39 x 11 mm

Con questo radiocomando si possono comandare fino a 4 ricevitori insieme o in modo separato per creare 4 zone di illuminazione. Consente di accendere, spegnere e regolare la luminosità di ogni zona singolarmente o in una unica soluzione.

### WIRELESS 4-ZONE CONTROL (to be paired to dimmer receiver)

Dimensions 137 x 39 x 11 mm

This wireless radiocontrol can be paired to max 4 dimmer receivers, thus creating 4 lighting areas. It allows to turn on, off and adjust the light intensity of each area distinctly or all together.

## ALIMENTATORI POWER SUPPLIES



CODICE ITEM CODE	DESCRIZIONE DESCRIPTION
08616190A	TRASFORMATORE 220-24V 20W 3 USCITE
08616191	TRASFORMATORE 220-24V 30W 6 USCITE
08616192A	TRASFORMATORE 220-24V 50W 6 USCITE
08616195	TRASFORMATORE 220-24V 75W 6 USCITE
08616201	TRASFORMATORE 220-24V 100W 6 USCITE
08616202	TRASFORMATORE 220-24V 150W 6 USCITE

## ALIMENTATORI POWER SUPPLIES

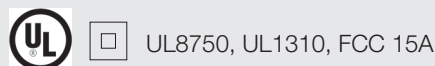

**U.S. and CANADA**



CODICE ITEM CODE	DESCRIZIONE DESCRIPTION
08616198	TRASFORMATORE 110-24V 30W 6 USCITE
08616200	TRASFORMATORE 110-24V 75W 6 USCITE





# MODULAR ACCESSORI

ACCESSORIES MODULAR

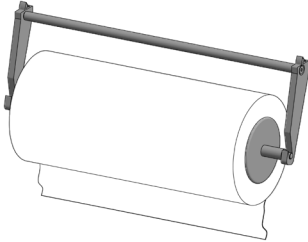
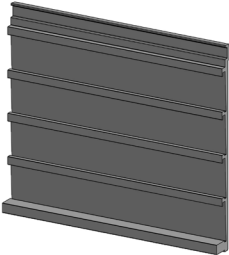
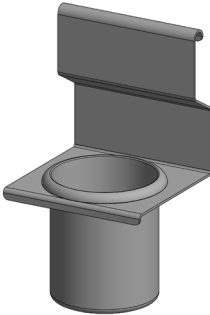
<p><b>Porta rotolo</b> Roll holder</p>  <p>L 24 P 9 H 9,5 W 24 D 9 H 9,5</p>	<p><b>CODICE</b> <i>CODE No.</i></p> <p><b>086M05</b></p>	<p><b>ACCIAIO</b> STEEL</p>	<p><b>TITANIO</b> TITANIUM</p>	<p><b>BRUNITO</b> BURNISHED</p>
<p><b>Porta capsule caffè</b> Coffee pod holder</p>  <p>L 22 P 3,1 H 19,5 W 22 D 3,1 H 19,5</p>	<p><b>086M06</b></p>			
<p><b>Porta contenitore alluminio/inox</b> Aluminium/stainless steel can holder</p>  <p>L 14 P 12,9 H 25 W 14 D 12,9 H 25</p>	<p><b>086M07</b></p>			

# MODULAR ACCESSORI

## ACCESSORIES MODULAR

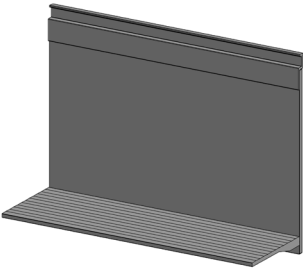
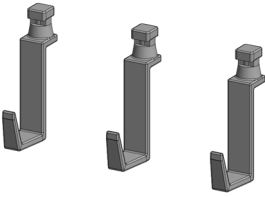
<p><b>Mensola vetro/alluminio</b></p> <p>Glass/Aluminium shelf</p>  <p>L 27 P 10,6 H 20,2</p>	<p><b>CODICE CODE No.</b></p> <p><b>086M08</b></p>	<p><b>ACCIAIO</b> STEEL</p>	<p><b>TITANIO</b> TITANIUM</p>	<p><b>BRUNITO</b> BURNISHED</p>
<p><b>Set ganci</b></p> <p>Hooks kit</p>  <p>W 27 D 10,6 H 20,2</p>	<p><b>086M01</b></p>			

# MODULAR ISOLA

MODULAR ISLAND

Modulo isola

Island hanging rack element

**CODICE**  
**CODE No.**

**ACCIAIO**  
STEEL

**TITANIO**  
TITANIUM

**BRUNITO**  
BURNISHED

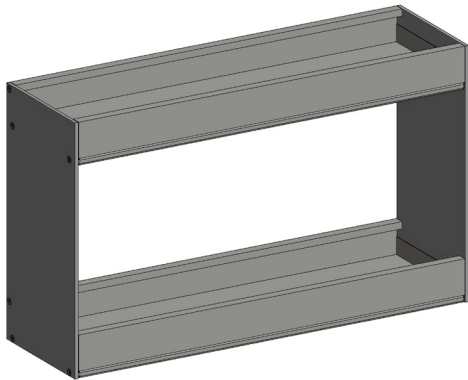

**N.B.: vaschette non incluse**  
Note: bowls not included

L 60 P 18 H 36  
L 90 P 18 H 36

W 60 D 18 H 36  
W 90 D 18 H 36

**08653000**  
**08653005**



## Finiture "MODULAR"

"MODULAR" finishes



**Acciaio (opz.A)**  
Stainless Steel

**Titanio (opz.T)**  
Titanium

**Brunito (opz.B)**  
Burnished

# MODULAR ACCESSORI

ACCESSORIES MODULAR

Vaschetta

Bowl

**CODICE**  
*CODE No.*

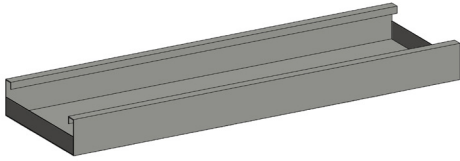

## Finiture

Finishes



**Acciaio (opz.A)**  
Stainless Steel

**Titanio (opz.T)**  
Titanium

**Brunito (opz.B)**  
Burnished



**Rame (opz.R)**  
Copper

**Grafite (opz.P)**  
Graphite

**Bronzo Anticato (opz.Z)**  
Antique Bronze

L 58,9 P 18 H 5  
W 58,9 D 18 H 5

Acciaio Stainless Steel  
Titanio Titanium  
Brunito Burnished  
Rame Copper  
Grafite Graphite  
Bronzo Anticato Antique Bronze

**08653015A**  
**08653015T**  
**08653015B**  
**08653015R**  
**08653015P**  
**08653015Z**

L 88,9 P 18 H 5  
W 88,9 D 18 H 5

Acciaio Stainless Steel  
Titanio Titanium  
Brunito Burnished  
Rame Copper  
Grafite Graphite  
Bronzo Anticato Antique Bronze

**08653020A**  
**08653020T**  
**08653020B**  
**08653020R**  
**08653020P**  
**08653020Z**

CUCINE  
**LUBE**

GRUPPO LUBE

**CREO**  
KITCHENS

Air



**Air** è un sistema di profili estrusi in alluminio che attraverso tre diversi modi di giunzione consentono di ottenere numerose tipologie di strutture per mobili ed espositori.

I profili consentono il montaggio di piani in legno, vetro o altri materiali.

**Air** is a system of extruded aluminum profiles which, through three different joining methods, allow to obtain numerous types of structures for furniture and displays.

The profiles allow to assembly shelves made of wood, glass or other materials.













La struttura può essere tamponata posteriormente con diversi materiali per lasciare massima libertà di personalizzazione.

Le sue composizioni standard sono pensate per poter essere inserite nelle zone kitchen e living.

**Air** è un sistema di grande affidabilità strutturale e valore estetico, ideale per la casa, per gli ambienti operativi o espositivi, e dovunque serva praticità e rapidità d'arredo.

The structure can be padded on the back with different materials, to have the maximum freedom of customization.

Its standard compositions are designed for the kitchen and living areas.

**Air** is a system of great structural reliability and aesthetic value, ideal for the home, for operational or exhibition environments, and wherever practical and quick furnishing is required.

---

# Pensili con schienale in lamiera e ripiani vetro

## Wall units with sheet metal back panel and metal and glass shelves

---

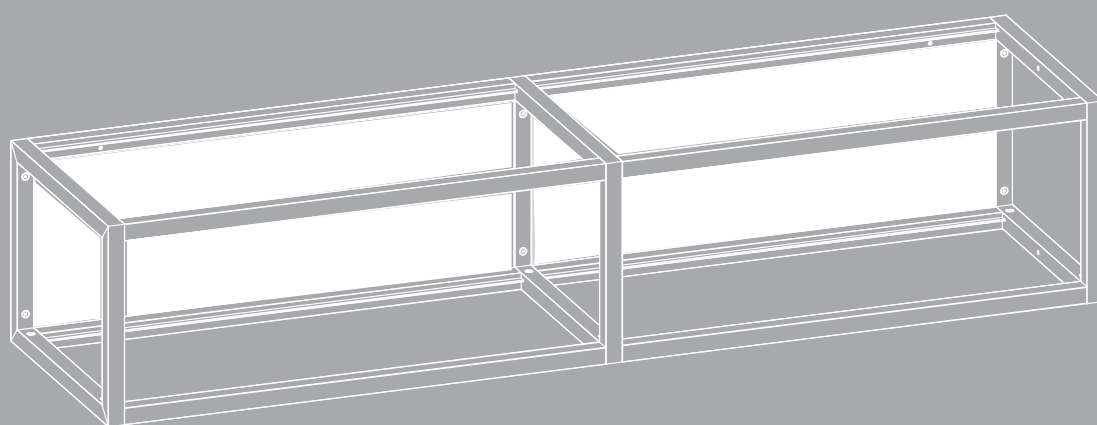

# Pensili H 240

## Wall Units

\*A/V: A=ANODIZZATO V=VERNICIATO  
ANODIZED PAINTED

CON SCHIENALE  
WITH BACK PANEL

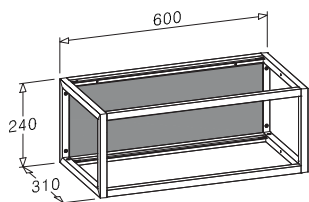

**ALTEZZA, LARGHEZZA E PROFONDITA'**  
**HEIGHT, WIDTH AND DEPTH**  
H.240 L.600 P.310 - H.240 W.600 D.310

**CODICE ARTICOLO** E7800060  
**ITEM NUMBER**

FINITURA FINISH	A/V*	OPZIONE COLORE COLOUR OPTION
■ Nero Black	A	AL11
■ Titanio Titanium	A	AL12
■ Selce Flint Grey	V	AL13
■ Silver Dark Dark Silver	V	AL14
■ Oro Rosa Pink Gold	V	AL17
■ Rame Copper	V	AL23
■ Ottone Brass	V	AL24
■ Umber Umber	V	AL26

**ALTEZZA, LARGHEZZA E PROFONDITA'**  
**HEIGHT, WIDTH AND DEPTH**  
H.240 L.900 P.310 - H.240 W.900 D.310

**CODICE ARTICOLO** E7800090  
**ITEM NUMBER**

FINITURA FINISH	A/V*	OPZIONE COLORE COLOUR OPTION
■ Nero Black	A	AL11
■ Titanio Titanium	A	AL12
■ Selce Flint Grey	V	AL13
■ Silver Dark Dark Silver	V	AL14
■ Oro Rosa Pink Gold	V	AL17
■ Rame Copper	V	AL23
■ Ottone Brass	V	AL24
■ Umber Umber	V	AL26

**ALTEZZA, LARGHEZZA E PROFONDITA'**  
**HEIGHT, WIDTH AND DEPTH**  
H.240 L.1200 P.310 - H.240 W.1200 D.310

**CODICE ARTICOLO** E7800120  
**ITEM NUMBER**

FINITURA FINISH	A/V*	OPZIONE COLORE COLOUR OPTION
■ Nero Black	A	AL11
■ Titanio Titanium	A	AL12
■ Selce Flint Grey	V	AL13
■ Silver Dark Dark Silver	V	AL14
■ Oro Rosa Pink Gold	V	AL17
■ Rame Copper	V	AL23
■ Ottone Brass	V	AL24
■ Umber Umber	V	AL26

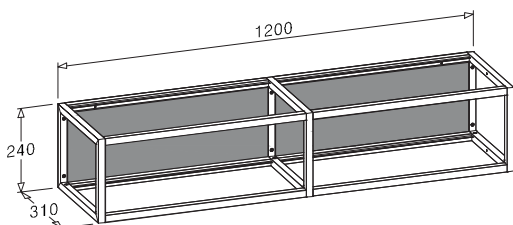
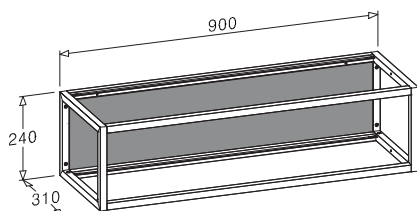

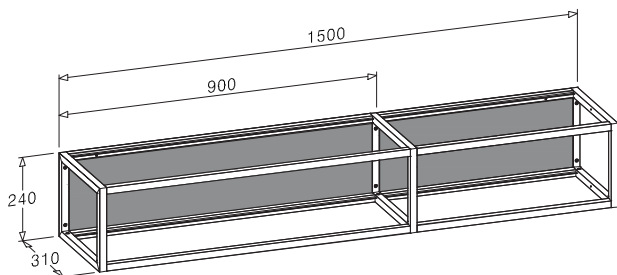

**VERSO DX  
TO THE RIGHT**

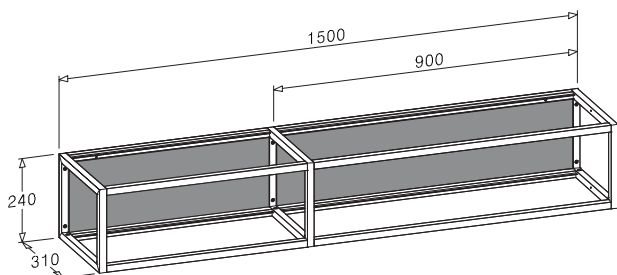

**VERSO SX  
TO THE LEFT**

**ALTEZZA, LARGHEZZA E PROFONDITA'**  
**HEIGHT, WIDTH AND DEPTH**  
H.240 L.1500 P.310 - H.240 W.1500 D.310

**CODICE ARTICOLO E7800151**  
**ITEM NUMBER**

FINITURA FINISH	A/V*	OPZIONE COLORE COLOUR OPTION
■ Nero Black	A	AL11
■ Titanio Titanium	A	AL12
■ Selce Flint Grey	V	AL13
■ Silver Dark Dark Silver	V	AL14
■ Oro Rosa Pink Gold	V	AL17
■ Rame Copper	V	AL23
■ Ottone Brass	V	AL24
■ Umber Umber	V	AL26

**ALTEZZA, LARGHEZZA E PROFONDITA'**  
**HEIGHT, WIDTH AND DEPTH**  
H.240 L.1500 P.310 - H.240 W.1500 D.310

**CODICE ARTICOLO E7800152**  
**ITEM NUMBER**

FINITURA FINISH	A/V*	OPZIONE COLORE COLOUR OPTION
■ Nero Black	A	AL11
■ Titanio Titanium	A	AL12
■ Selce Flint Grey	V	AL13
■ Silver Dark Dark Silver	V	AL14
■ Oro Rosa Pink Gold	V	AL17
■ Rame Copper	V	AL23
■ Ottone Brass	V	AL24
■ Umber Umber	V	AL26

**FINITURE PER RIPIANI VETRO**  
**FINISHES FOR GLASS SHELVES**

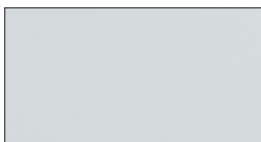

**VETRO TRASPARENTE**  
**TRANSPARENT GLASS**



**VETRO FUME' TRASPARENTE**  
**TRANSPARENT SMOKED GLASS**



**VETRO BRONZO TRASPARENTE**  
**TRANSPARENT BRONZE GLASS**

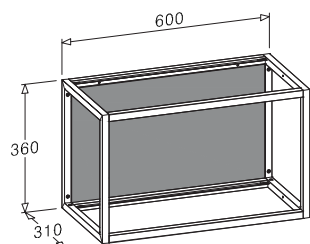

**ALTEZZA, LARGHEZZA E PROFONDITA'**  
**HEIGHT, WIDTH AND DEPTH**  
H.360 L.600 P.310 - H.360 W.600 D.310

**CODICE ARTICOLO** E7801060  
**ITEM NUMBER**

FINITURA FINISH	A/V*	OPZIONE COLORE COLOUR OPTION
■ Nero Black	A	AL11
■ Titanio Titanium	A	AL12
■ Selce Flint Grey	V	AL13
■ Silver Dark Dark Silver	V	AL14
■ Oro Rosa Pink Gold	V	AL17
■ Rame Copper	V	AL23
■ Ottone Brass	V	AL24
■ Umber Umber	V	AL26

**ALTEZZA, LARGHEZZA E PROFONDITA'**  
**HEIGHT, WIDTH AND DEPTH**  
H.360 L.900 P.310 - H.360 W.900 D.310

**CODICE ARTICOLO** E7801090  
**ITEM NUMBER**

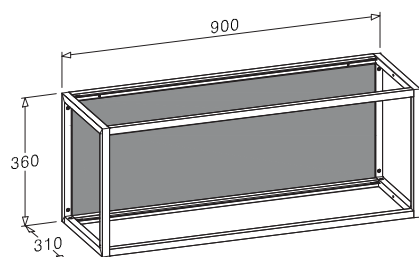

FINITURA FINISH	A/V*	OPZIONE COLORE COLOUR OPTION
■ Nero Black	A	AL11
■ Titanio Titanium	A	AL12
■ Selce Flint Grey	V	AL13
■ Silver Dark Dark Silver	V	AL14
■ Oro Rosa Pink Gold	V	AL17
■ Rame Copper	V	AL23
■ Ottone Brass	V	AL24
■ Umber Umber	V	AL26

**ALTEZZA, LARGHEZZA E PROFONDITA'**  
**HEIGHT, WIDTH AND DEPTH**  
H.360 L.1200 P.310 - H.360 W.1200 D.310

**CODICE ARTICOLO** E7801120  
**ITEM NUMBER**

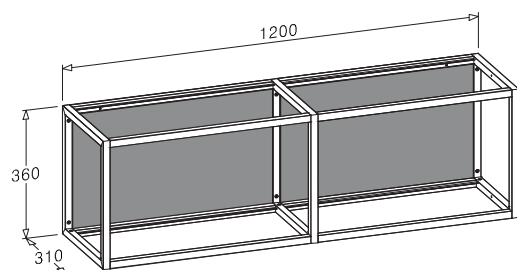

FINITURA FINISH	A/V*	OPZIONE COLORE COLOUR OPTION
■ Nero Black	A	AL11
■ Titanio Titanium	A	AL12
■ Selce Flint Grey	V	AL13
■ Silver Dark Dark Silver	V	AL14
■ Oro Rosa Pink Gold	V	AL17
■ Rame Copper	V	AL23
■ Ottone Brass	V	AL24
■ Umber Umber	V	AL26

**Pensili H 360**  
Wall Units

\*A/V: A=ANODIZZATO V=VERNICIATO  
ANODIZED PAINTED

CON SCHIENALE  
WITH BACK PANEL

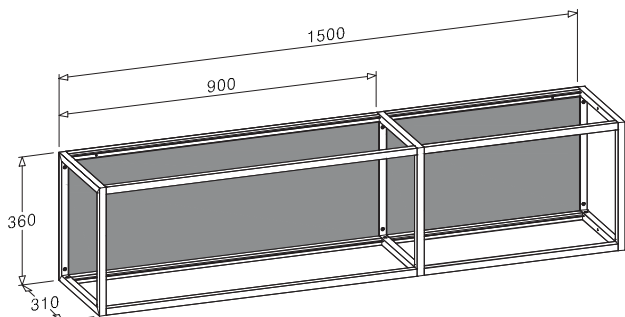

**VERSO DX**  
**TO THE RIGHT**

**ALTEZZA, LARGHEZZA E PROFONDITA'**  
**HEIGHT, WIDTH AND DEPTH**  
H.360 L.1500 P.310 - H.360 W.1500 D.310

**CODICE ARTICOLO E7801151**  
**ITEM NUMBER**

FINITURA FINISH	A/V*	OPZIONE COLORE COLOUR OPTION
■ Nero Black	A	AL11
■ Titanio Titanium	A	AL12
■ Selce Flint Grey	V	AL13
■ Silver Dark Dark Silver	V	AL14
■ Oro Rosa Pink Gold	V	AL17
■ Rame Copper	V	AL23
■ Ottone Brass	V	AL24
■ Umber Umber	V	AL26

**ALTEZZA, LARGHEZZA E PROFONDITA'**  
**HEIGHT, WIDTH AND DEPTH**  
H.360 L.1500 P.310 - H.360 W.1500 D.310

**CODICE ARTICOLO E7801152**  
**ITEM NUMBER**

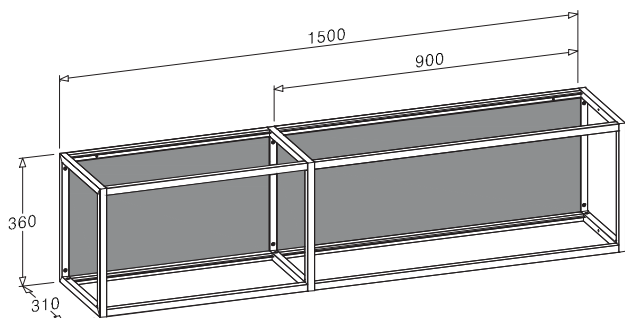

**VERSO SX**  
**TO THE LEFT**

FINITURA FINISH	A/V*	OPZIONE COLORE COLOUR OPTION
■ Nero Black	A	AL11
■ Titanio Titanium	A	AL12
■ Selce Flint Grey	V	AL13
■ Silver Dark Dark Silver	V	AL14
■ Oro Rosa Pink Gold	V	AL17
■ Rame Copper	V	AL23
■ Ottone Brass	V	AL24
■ Umber Umber	V	AL26

**FINITURE PER RIPIANI VETRO**  
**FINISHES FOR GLASS SHELVES**

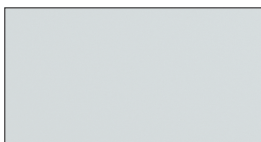

**VETRO TRASPARENTE**  
**TRANSPARENT GLASS**



**VETRO FUME' TRASPARENTE**  
**TRANSPARENT SMOKED GLASS**



**VETRO BRONZO TRASPARENTE**  
**TRANSPARENT BRONZE GLASS**



**Pensili H 480**  
Wall Units

**\*A/V: A=ANODIZZATO V=VERNICIATO**  
ANODIZED PAINTED

CON SCHIENALE  
WITH BACK PANEL

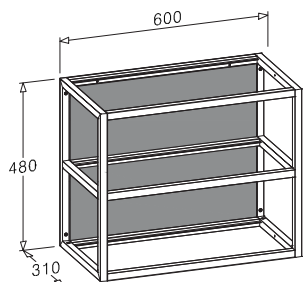

**ALTEZZA, LARGHEZZA E PROFONDITA'**  
**HEIGHT, WIDTH AND DEPTH**  
H.480 L.600 P.310 - H.480 W.600 D.310

**CODICE ARTICOLO E7802060**  
**ITEM NUMBER**

FINITURA FINISH	A/V*	OPZIONE COLORE COLOUR OPTION
■ <b>Nero</b> Black	A	AL11
■ <b>Titanio</b> Titanium	A	AL12
■ <b>Selce</b> Flint Grey	V	AL13
■ <b>Silver Dark</b> Dark Silver	V	AL14
■ <b>Oro Rosa</b> Pink Gold	V	AL17
■ <b>Rame</b> Copper	V	AL23
■ <b>Ottone</b> Brass	V	AL24
■ <b>Umber</b> Umber	V	AL26

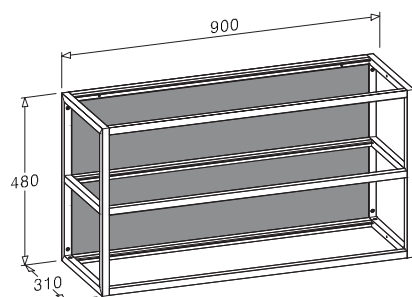

**ALTEZZA, LARGHEZZA E PROFONDITA'**  
**HEIGHT, WIDTH AND DEPTH**  
H.480 L.900 P.310 - H.480 W.900 D.310

**CODICE ARTICOLO E7802090**  
**ITEM NUMBER**

FINITURA FINISH	A/V*	OPZIONE COLORE COLOUR OPTION
■ <b>Nero</b> Black	A	AL11
■ <b>Titanio</b> Titanium	A	AL12
■ <b>Selce</b> Flint Grey	V	AL13
■ <b>Silver Dark</b> Dark Silver	V	AL14
■ <b>Oro Rosa</b> Pink Gold	V	AL17
■ <b>Rame</b> Copper	V	AL23
■ <b>Ottone</b> Brass	V	AL24
■ <b>Umber</b> Umber	V	AL26

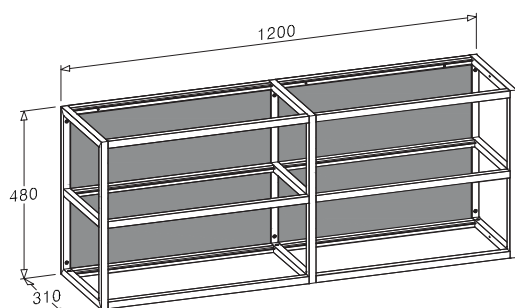

**ALTEZZA, LARGHEZZA E PROFONDITA'**  
**HEIGHT, WIDTH AND DEPTH**  
H.480 L.1200 P.310 - H.480 W.1200 D.310

**CODICE ARTICOLO E7802120**  
**ITEM NUMBER**

FINITURA FINISH	A/V*	OPZIONE COLORE COLOUR OPTION
■ <b>Nero</b> Black	A	AL11
■ <b>Titanio</b> Titanium	A	AL12
■ <b>Selce</b> Flint Grey	V	AL13
■ <b>Silver Dark</b> Dark Silver	V	AL14
■ <b>Oro Rosa</b> Pink Gold	V	AL17
■ <b>Rame</b> Copper	V	AL23
■ <b>Ottone</b> Brass	V	AL24
■ <b>Umber</b> Umber	V	AL26

# Pensili H 480

## Wall Units

\*A/V: A=ANODIZZATO V=VERNICIATO  
ANODIZED PAINTED

CON SCHIENALE  
WITH BACK PANEL

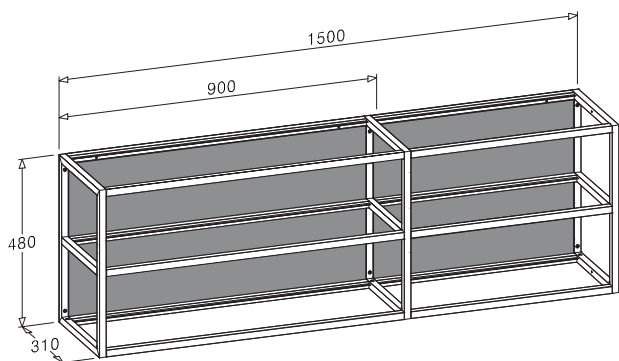

**VERSO DX**  
**TO THE RIGHT**

**ALTEZZA, LARGHEZZA E PROFONDITA'**  
**HEIGHT, WIDTH AND DEPTH**  
H.480 L.1500 P.310 - H.480 W.1500 D.310

**CODICE ARTICOLO E7802151**  
**ITEM NUMBER**

FINITURA FINISH	A/V*	OPZIONE COLORE COLOUR OPTION
■ Nero Black	A	AL11
■ Titanio Titanium	A	AL12
■ Selce Flint Grey	V	AL13
■ Silver Dark Dark Silver	V	AL14
■ Oro Rosa Pink Gold	V	AL17
■ Rame Copper	V	AL23
■ Ottone Brass	V	AL24
■ Umber Umber	V	AL26

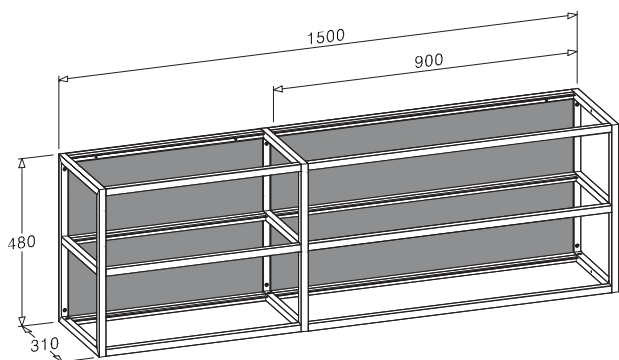

**VERSO SX**  
**TO THE LEFT**

**ALTEZZA, LARGHEZZA E PROFONDITA'**  
**HEIGHT, WIDTH AND DEPTH**  
H.480 L.1500 P.310 - H.480 W.1500 D.310

**CODICE ARTICOLO E7802152**  
**ITEM NUMBER**

FINITURA FINISH	A/V*	OPZIONE COLORE COLOUR OPTION
■ Nero Black	A	AL11
■ Titanio Titanium	A	AL12
■ Selce Flint Grey	V	AL13
■ Silver Dark Dark Silver	V	AL14
■ Oro Rosa Pink Gold	V	AL17
■ Rame Copper	V	AL23
■ Ottone Brass	V	AL24
■ Umber Umber	V	AL26

### FINITURE PER RIPIANI VETRO

#### FINISHES FOR GLASS SHELVES

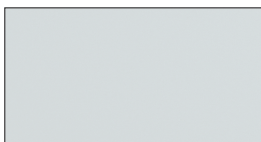

**VETRO TRASPARENTE**  
**TRANSPARENT GLASS**



**VETRO FUME' TRASPARENTE**  
**TRANSPARENT SMOKED GLASS**



**VETRO BRONZO TRASPARENTE**  
**TRANSPARENT BRONZE GLASS**

# Pensili H 600

## Wall Units

\*A/V: A=ANODIZZATO V=VERNICIATO  
ANODIZED PAINTED

CON SCHIENALE  
WITH BACK PANEL

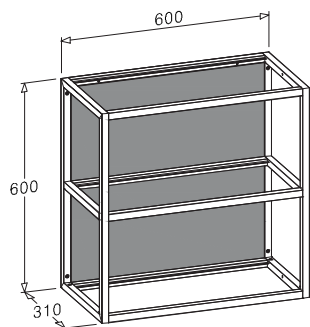

**ALTEZZA, LARGHEZZA E PROFONDITA'**  
**HEIGHT, WIDTH AND DEPTH**  
H.600 L.600 P.310 - H.600 W.600 D.310

**CODICE ARTICOLO** E7803060  
**ITEM NUMBER**

FINITURA FINISH	A/V*	OPZIONE COLORE COLOUR OPTION
■ Nero Black	A	AL11
■ Titanio Titanium	A	AL12
■ Selce Flint Grey	V	AL13
■ Silver Dark Dark Silver	V	AL14
■ Oro Rosa Pink Gold	V	AL17
■ Rame Copper	V	AL23
■ Ottone Brass	V	AL24
■ Umber Umber	V	AL26

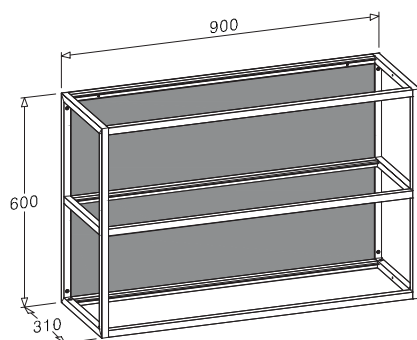

**ALTEZZA, LARGHEZZA E PROFONDITA'**  
**HEIGHT, WIDTH AND DEPTH**  
H.600 L.900 P.310 - H.600 W.900 D.310

**CODICE ARTICOLO** E7803090  
**ITEM NUMBER**

FINITURA FINISH	A/V*	OPZIONE COLORE COLOUR OPTION
■ Nero Black	A	AL11
■ Titanio Titanium	A	AL12
■ Selce Flint Grey	V	AL13
■ Silver Dark Dark Silver	V	AL14
■ Oro Rosa Pink Gold	V	AL17
■ Rame Copper	V	AL23
■ Ottone Brass	V	AL24
■ Umber Umber	V	AL26

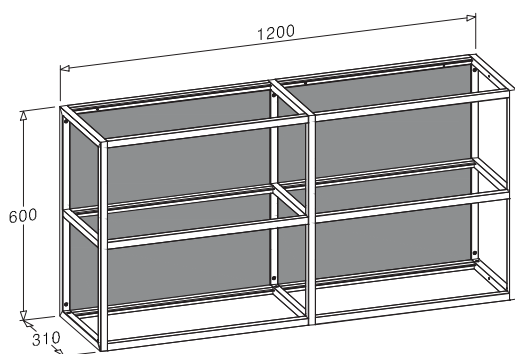

**ALTEZZA, LARGHEZZA E PROFONDITA'**  
**HEIGHT, WIDTH AND DEPTH**  
H.600 L.1200 P.310 - H.600 W.1200 D.310

**CODICE ARTICOLO** E7803120  
**ITEM NUMBER**

FINITURA FINISH	A/V*	OPZIONE COLORE COLOUR OPTION
■ Nero Black	A	AL11
■ Titanio Titanium	A	AL12
■ Selce Flint Grey	V	AL13
■ Silver Dark Dark Silver	V	AL14
■ Oro Rosa Pink Gold	V	AL17
■ Rame Copper	V	AL23
■ Ottone Brass	V	AL24
■ Umber Umber	V	AL26

# Pensili H 600

## Wall Units

\*A/V: A=ANODIZZATO V=VERNICIATO  
ANODIZED PAINTED

CON SCHIENALE  
WITH BACK PANEL

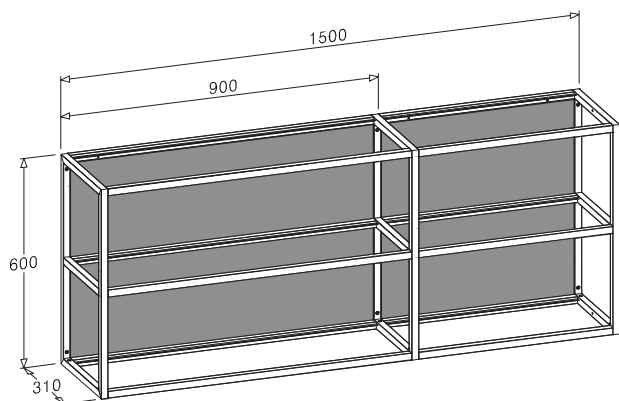

**VERSO DX**  
**TO THE RIGHT**

**ALTEZZA, LARGHEZZA E PROFONDITA'**  
**HEIGHT, WIDTH AND DEPTH**  
H.600 L.1500 P.310 - H.600 W.1500 D.310

**CODICE ARTICOLO E7803151**  
**ITEM NUMBER**

FINITURA FINISH	A/V*	OPZIONE COLORE COLOUR OPTION
■ Nero Black	A	AL11
■ Titanio Titanium	A	AL12
■ Selce Flint Grey	V	AL13
■ Silver Dark Dark Silver	V	AL14
■ Oro Rosa Pink Gold	V	AL17
■ Rame Copper	V	AL23
■ Ottone Brass	V	AL24
■ Umber Umber	V	AL26

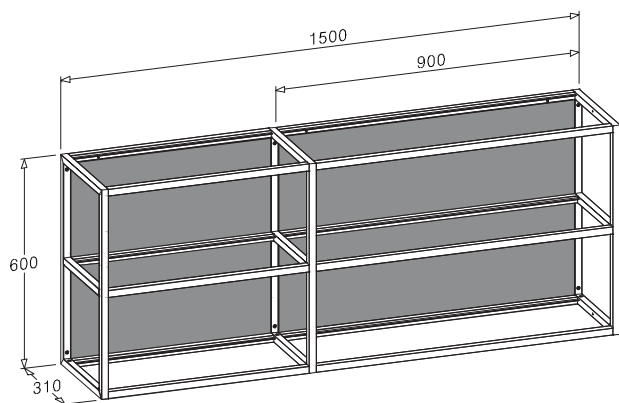

**VERSO SX**  
**TO THE LEFT**

**ALTEZZA, LARGHEZZA E PROFONDITA'**  
**HEIGHT, WIDTH AND DEPTH**  
H.600 L.1500 P.310 - H.600 W.1500 D.310

**CODICE ARTICOLO E7803152**  
**ITEM NUMBER**

FINITURA FINISH	A/V*	OPZIONE COLORE COLOUR OPTION
■ Nero Black	A	AL11
■ Titanio Titanium	A	AL12
■ Selce Flint Grey	V	AL13
■ Silver Dark Dark Silver	V	AL14
■ Oro Rosa Pink Gold	V	AL17
■ Rame Copper	V	AL23
■ Ottone Brass	V	AL24
■ Umber Umber	V	AL26

### FINITURE PER RIPIANI VETRO

#### FINISHES FOR GLASS SHELVES

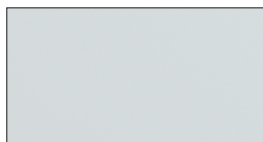

**VETRO TRASPARENTE**  
**TRANSPARENT GLASS**



**VETRO FUME' TRASPARENTE**  
**TRANSPARENT SMOKED GLASS**



**VETRO BRONZO TRASPARENTE**  
**TRANSPARENT BRONZE GLASS**

---

# Pensili con schiena personalizzata e ripiani vetro

## Wall units with personalized back panel and glass shelves

---

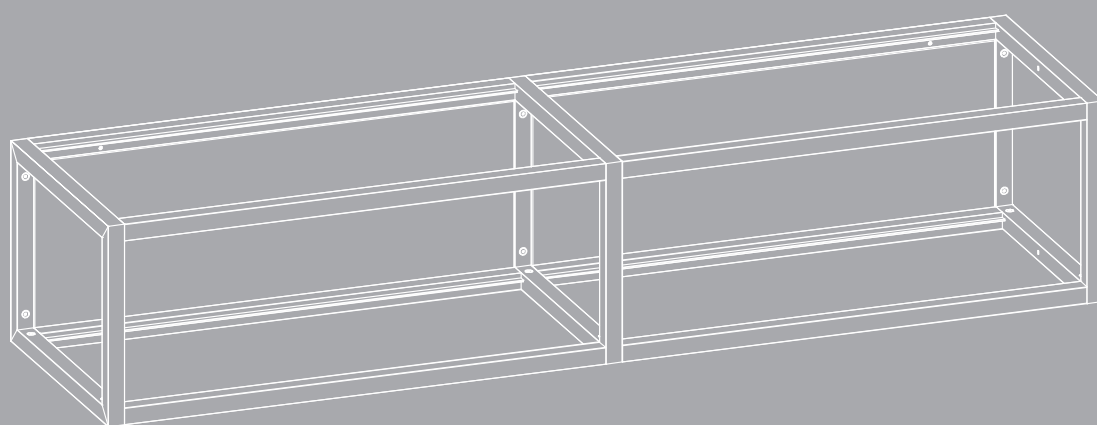

# Pensili H 240

## Wall Units

\*A/V: A=ANODIZZATO V=VERNICIATO  
ANODIZED PAINTED

**N.B.: PER I COLORI DELLE SCHIENE VEDI PAG:74-77**  
**NOTE: FOR THE BACK PANEL COLORS SEE PAGE 74-77**

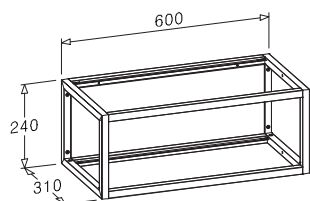

**ALTEZZA, LARGHEZZA E PROFONDITA'**  
**HEIGHT, WIDTH AND DEPTH**  
H.240 L.600 P.310 - H.240 W.600 D.310

**CODICE ARTICOLO E7750060**  
**ITEM NUMBER**

FINITURA FINISH	A/V*	OPZIONE COLORE COLOUR OPTION
■ Nero Black	A	AL11
■ Titanio Titanium	A	AL12
■ Selce Flint Grey	V	AL13
■ Silver Dark Dark Silver	V	AL14
■ Oro Rosa Pink Gold	V	AL17
■ Rame Copper	V	AL23
■ Ottone Brass	V	AL24
■ Umber Umber	V	AL26

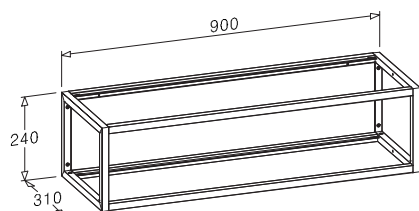

**ALTEZZA, LARGHEZZA E PROFONDITA'**  
**HEIGHT, WIDTH AND DEPTH**  
H.240 L.900 P.310 - H.240 W.900 D.310

**CODICE ARTICOLO E7750090**  
**ITEM NUMBER**

FINITURA FINISH	A/V*	OPZIONE COLORE COLOUR OPTION
■ Nero Black	A	AL11
■ Titanio Titanium	A	AL12
■ Selce Flint Grey	V	AL13
■ Silver Dark Dark Silver	V	AL14
■ Oro Rosa Pink Gold	V	AL17
■ Rame Copper	V	AL23
■ Ottone Brass	V	AL24
■ Umber Umber	V	AL26

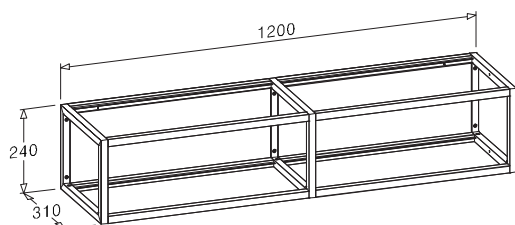

**ALTEZZA, LARGHEZZA E PROFONDITA'**  
**HEIGHT, WIDTH AND DEPTH**  
H.240 L.1200 P.310 - H.240 W.1200 D.310

**CODICE ARTICOLO E7750120**  
**ITEM NUMBER**

FINITURA FINISH	A/V*	OPZIONE COLORE COLOUR OPTION
■ Nero Black	A	AL11
■ Titanio Titanium	A	AL12
■ Selce Flint Grey	V	AL13
■ Silver Dark Dark Silver	V	AL14
■ Oro Rosa Pink Gold	V	AL17
■ Rame Copper	V	AL23
■ Ottone Brass	V	AL24
■ Umber Umber	V	AL26

# Pensili H 240

Wall Units

\*A/V: A=ANODIZZATO V=VERNICIATO  
ANODIZED PAINTED

**N.B.: PER I COLORI DELLE SCHIENE VEDI PAG:74-77**  
**NOTE: FOR THE BACK PANEL COLORS SEE PAGE 74-77**

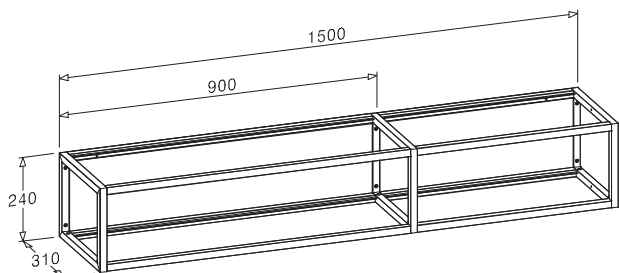

**VERSO DX**  
**TO THE RIGHT**

## ALTEZZA, LARGHEZZA E PROFONDITA'

HEIGHT, WIDTH AND DEPTH

H.240 L.1500 P.310 - H.240 W.1500 D.310

**CODICE ARTICOLO E7750151**

ITEM NUMBER

FINITURA FINISH	A/V*	OPZIONE COLORE COLOUR OPTION
■ Nero Black	A	AL11
■ Titanio Titanium	A	AL12
■ Selce Flint Grey	V	AL13
■ Silver Dark Dark Silver	V	AL14
■ Oro Rosa Pink Gold	V	AL17
■ Rame Copper	V	AL23
■ Ottone Brass	V	AL24
■ Umber Umber	V	AL26

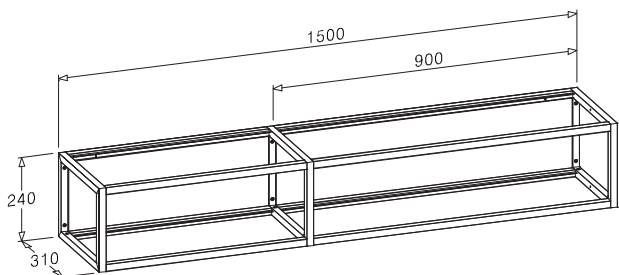

**VERSO SX**  
**TO THE LEFT**

## ALTEZZA, LARGHEZZA E PROFONDITA'

HEIGHT, WIDTH AND DEPTH

H.240 L.1500 P.310 - H.240 W.1500 D.310

**CODICE ARTICOLO E7750152**

ITEM NUMBER

FINITURA FINISH	A/V*	OPZIONE COLORE COLOUR OPTION
■ Nero Black	A	AL11
■ Titanio Titanium	A	AL12
■ Selce Flint Grey	V	AL13
■ Silver Dark Dark Silver	V	AL14
■ Oro Rosa Pink Gold	V	AL17
■ Rame Copper	V	AL23
■ Ottone Brass	V	AL24
■ Umber Umber	V	AL26

## FINITURE PER RIPIANI VETRO

FINISHES FOR GLASS SHELVES

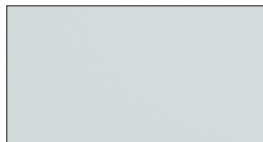

**VETRO TRASPARENTE**  
**TRANSPARENT GLASS**



**VETRO FUME' TRASPARENTE**  
**TRANSPARENT SMOKED GLASS**



**VETRO BRONZO TRASPARENTE**  
**TRANSPARENT BRONZE GLASS**

**Pensili H 360**  
Wall Units

\*A/V: A=ANODIZZATO V=VERNICIATO  
ANODIZED PAINTED

**N.B.: PER I COLORI DELLE SCHIENE VEDI PAG:74-77**  
**NOTE: FOR THE BACK PANEL COLORS SEE PAGE 74-77**

**ALTEZZA, LARGHEZZA E PROFONDITA'**  
**HEIGHT, WIDTH AND DEPTH**  
H.360 L.600 P.310 - H.360 W.600 D.310

**CODICE ARTICOLO E7751060**  
**ITEM NUMBER**

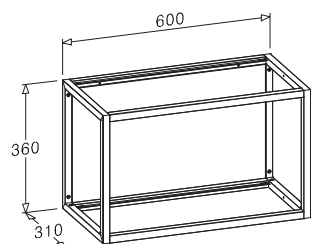

FINITURA FINISH	A/V*	OPZIONE COLORE COLOUR OPTION
■ Nero Black	A	AL11
■ Titanio Titanium	A	AL12
■ Selce Flint Grey	V	AL13
■ Silver Dark Dark Silver	V	AL14
■ Oro Rosa Pink Gold	V	AL17
■ Rame Copper	V	AL23
■ Ottone Brass	V	AL24
■ Umber Umber	V	AL26

**ALTEZZA, LARGHEZZA E PROFONDITA'**  
**HEIGHT, WIDTH AND DEPTH**  
H.360 L.900 P.310 - H.360 W.900 D.310

**CODICE ARTICOLO E7751090**  
**ITEM NUMBER**

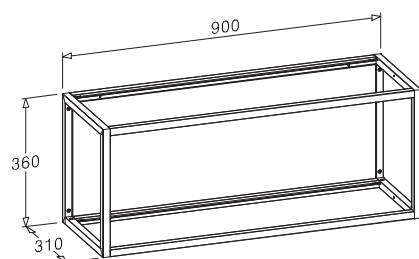

FINITURA FINISH	A/V*	OPZIONE COLORE COLOUR OPTION
■ Nero Black	A	AL11
■ Titanio Titanium	A	AL12
■ Selce Flint Grey	V	AL13
■ Silver Dark Dark Silver	V	AL14
■ Oro Rosa Pink Gold	V	AL17
■ Rame Copper	V	AL23
■ Ottone Brass	V	AL24
■ Umber Umber	V	AL26

**ALTEZZA, LARGHEZZA E PROFONDITA'**  
**HEIGHT, WIDTH AND DEPTH**  
H.360 L.1200 P.310 - H.360 W.1200 D.310

**CODICE ARTICOLO E7751120**  
**ITEM NUMBER**

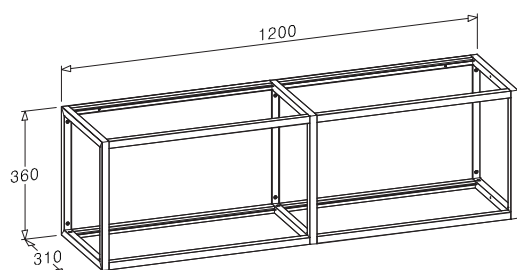

FINITURA FINISH	A/V*	OPZIONE COLORE COLOUR OPTION
■ Nero Black	A	AL11
■ Titanio Titanium	A	AL12
■ Selce Flint Grey	V	AL13
■ Silver Dark Dark Silver	V	AL14
■ Oro Rosa Pink Gold	V	AL17
■ Rame Copper	V	AL23
■ Ottone Brass	V	AL24
■ Umber Umber	V	AL26



# Pensili H 360

## Wall Units

\*A/V: A=ANODIZZATO V=VERNICIATO  
ANODIZED PAINTED

**N.B.: PER I COLORI DELLE SCHIENE VEDI PAG:74-77**  
**NOTE: FOR THE BACK PANEL COLORS SEE PAGE 74-77**

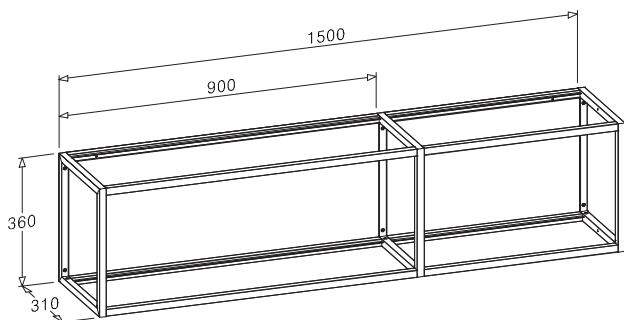

**VERSO DX**  
**TO THE RIGHT**

### ALTEZZA, LARGHEZZA E PROFONDITA'

HEIGHT, WIDTH AND DEPTH  
H.360 L.1500 P.310 - H.360 W.1500 D.310

**CODICE ARTICOLO E7751151**  
ITEM NUMBER

FINITURA FINISH	A/V*	OPZIONE COLORE COLOUR OPTION
■ Nero Black	A	AL11
■ Titanio Titanium	A	AL12
■ Selce Flint Grey	V	AL13
■ Silver Dark Dark Silver	V	AL14
■ Oro Rosa Pink Gold	V	AL17
■ Rame Copper	V	AL23
■ Ottone Brass	V	AL24
■ Umber Umber	V	AL26

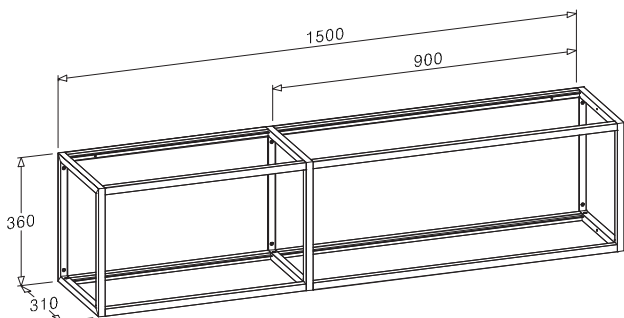

**VERSO SX**  
**TO THE LEFT**

### ALTEZZA, LARGHEZZA E PROFONDITA'

HEIGHT, WIDTH AND DEPTH  
H.360 L.1500 P.310 - H.360 W.1500 D.310

**CODICE ARTICOLO E7751152**  
ITEM NUMBER

FINITURA FINISH	A/V*	OPZIONE COLORE COLOUR OPTION
■ Nero Black	A	AL11
■ Titanio Titanium	A	AL12
■ Selce Flint Grey	V	AL13
■ Silver Dark Dark Silver	V	AL14
■ Oro Rosa Pink Gold	V	AL17
■ Rame Copper	V	AL23
■ Ottone Brass	V	AL24
■ Umber Umber	V	AL26

### FINITURE PER RIPIANI VETRO

#### FINISHES FOR GLASS SHELVES

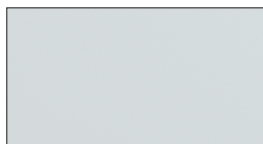

**VETRO TRASPARENTE**  
TRANSPARENT GLASS



**VETRO FUME' TRASPARENTE**  
TRANSPARENT SMOKED GLASS



**VETRO BRONZO TRASPARENTE**  
TRANSPARENT BRONZE GLASS

**Pensili H 480**  
Wall Units

\*A/V: A=ANODIZZATO V=VERNICIATO  
ANODIZED PAINTED

**N.B.: PER I COLORI DELLE SCHIENE VEDI PAG:74-77**  
**NOTE: FOR THE BACK PANEL COLORS SEE PAGE 74-77**

**ALTEZZA, LARGHEZZA E PROFONDITA'**  
**HEIGHT, WIDTH AND DEPTH**  
H.480 L.600 P.310 - H.480 W.600 D.310

**CODICE ARTICOLO E7752060**  
**ITEM NUMBER**

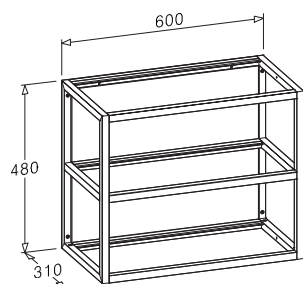

FINITURA FINISH	A/V*	OPZIONE COLORE COLOUR OPTION
■ Nero Black	A	AL11
■ Titanio Titanium	A	AL12
■ Selce Flint Grey	V	AL13
■ Silver Dark Dark Silver	V	AL14
■ Oro Rosa Pink Gold	V	AL17
■ Rame Copper	V	AL23
■ Ottone Brass	V	AL24
■ Umber Umber	V	AL26

**ALTEZZA, LARGHEZZA E PROFONDITA'**  
**HEIGHT, WIDTH AND DEPTH**  
H.480 L.900 P.310 - H.480 W.900 D.310

**CODICE ARTICOLO E7752090**  
**ITEM NUMBER**

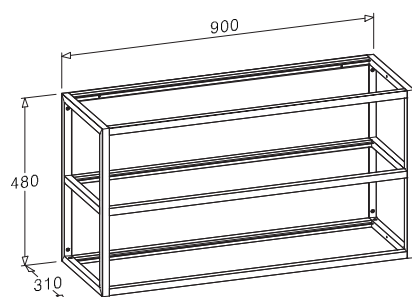

FINITURA FINISH	A/V*	OPZIONE COLORE COLOUR OPTION
■ Nero Black	A	AL11
■ Titanio Titanium	A	AL12
■ Selce Flint Grey	V	AL13
■ Silver Dark Dark Silver	V	AL14
■ Oro Rosa Pink Gold	V	AL17
■ Rame Copper	V	AL23
■ Ottone Brass	V	AL24
■ Umber Umber	V	AL26

**ALTEZZA, LARGHEZZA E PROFONDITA'**  
**HEIGHT, WIDTH AND DEPTH**  
H.480 L.1200 P.310 - H.480 W.1200 D.310

**CODICE ARTICOLO E7752120**  
**ITEM NUMBER**

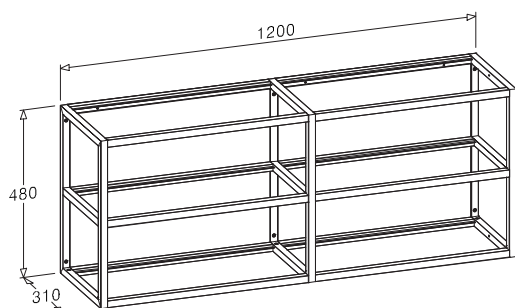

FINITURA FINISH	A/V*	OPZIONE COLORE COLOUR OPTION
■ Nero Black	A	AL11
■ Titanio Titanium	A	AL12
■ Selce Flint Grey	V	AL13
■ Silver Dark Dark Silver	V	AL14
■ Oro Rosa Pink Gold	V	AL17
■ Rame Copper	V	AL23
■ Ottone Brass	V	AL24
■ Umber Umber	V	AL26

**Pensili H 480**  
Wall Units

\*A/V: A=ANODIZZATO V=VERNICIATO  
ANODIZED PAINTED

**N.B.: PER I COLORI DELLE SCHIENE VEDI PAG:74-77**  
**NOTE: FOR THE BACK PANEL COLORS SEE PAGE 74-77**

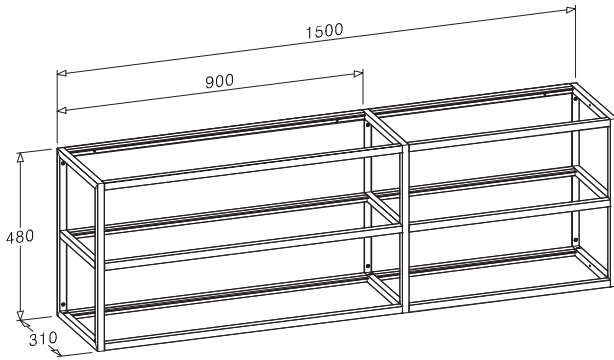

**VERSO DX**  
**TO THE RIGHT**

**ALTEZZA, LARGHEZZA E PROFONDITA'**  
**HEIGHT, WIDTH AND DEPTH**  
H.480 L.1500 P.310 - H.480 W.1500 D.310

**CODICE ARTICOLO** E7752151  
**ITEM NUMBER**

FINITURA FINISH	A/V*	OPZIONE COLORE COLOUR OPTION
■ Nero Black	A	AL11
■ Titanio Titanium	A	AL12
■ Selce Flint Grey	V	AL13
■ Silver Dark Dark Silver	V	AL14
■ Oro Rosa Pink Gold	V	AL17
■ Rame Copper	V	AL23
■ Ottone Brass	V	AL24
■ Umber Umber	V	AL26

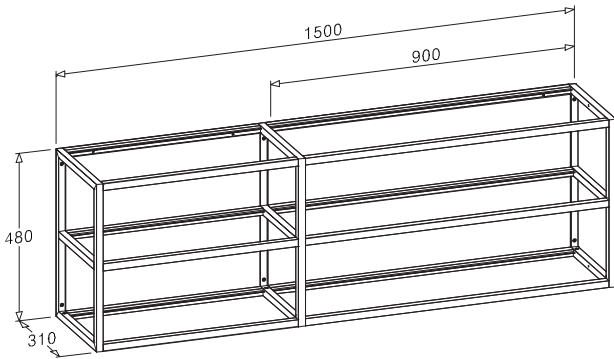

**VERSO SX**  
**TO THE LEFT**

**ALTEZZA, LARGHEZZA E PROFONDITA'**  
**HEIGHT, WIDTH AND DEPTH**  
H.480 L.1500 P.310 - H.480 W.1500 D.310

**CODICE ARTICOLO** E7752152  
**ITEM NUMBER**

FINITURA FINISH	A/V*	OPZIONE COLORE COLOUR OPTION
■ Nero Black	A	AL11
■ Titanio Titanium	A	AL12
■ Selce Flint Grey	V	AL13
■ Silver Dark Dark Silver	V	AL14
■ Oro Rosa Pink Gold	V	AL17
■ Rame Copper	V	AL23
■ Ottone Brass	V	AL24
■ Umber Umber	V	AL26

**FINITURE PER RIPIANI VETRO**  
**FINISHES FOR GLASS SHELVES**

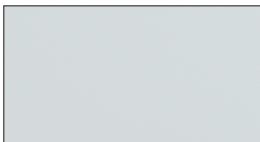

**VETRO TRASPARENTE**  
**TRANSPARENT GLASS**



**VETRO FUME' TRASPARENTE**  
**TRANSPARENT SMOKED GLASS**



**VETRO BRONZO TRASPARENTE**  
**TRANSPARENT BRONZE GLASS**

**Pensili H 600**  
Wall Units

\*A/V: A=ANODIZZATO V=VERNICIATO  
ANODIZED PAINTED

**N.B.: PER I COLORI DELLE SCHIENE VEDI PAG:74-77**  
**NOTE: FOR THE BACK PANEL COLORS SEE PAGE 74-77**

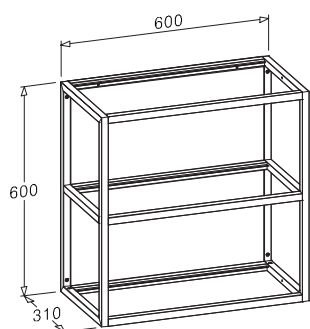

**ALTEZZA, LARGHEZZA E PROFONDITA'**  
**HEIGHT, WIDTH AND DEPTH**  
H.600 L.600 P.310 - H.600 W.600 D.310

**CODICE ARTICOLO E7753060**  
**ITEM NUMBER**

FINITURA FINISH	A/V*	OPZIONE COLORE COLOUR OPTION
■ Nero Black	A	AL11
■ Titanio Titanium	A	AL12
■ Selce Flint Grey	V	AL13
■ Silver Dark Dark Silver	V	AL14
■ Oro Rosa Pink Gold	V	AL17
■ Rame Copper	V	AL23
■ Ottone Brass	V	AL24
■ Umber Umber	V	AL26

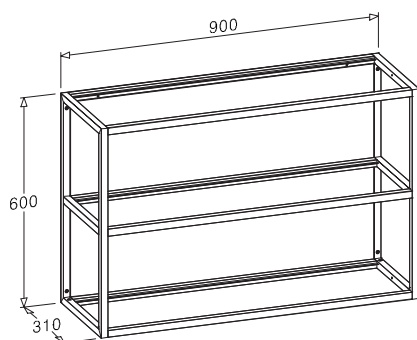

**ALTEZZA, LARGHEZZA E PROFONDITA'**  
**HEIGHT, WIDTH AND DEPTH**  
H.600 L.900 P.310 - H.600 W.900 D.310

**CODICE ARTICOLO E7753090**  
**ITEM NUMBER**

FINITURA FINISH	A/V*	OPZIONE COLORE COLOUR OPTION
■ Nero Black	A	AL11
■ Titanio Titanium	A	AL12
■ Selce Flint Grey	V	AL13
■ Silver Dark Dark Silver	V	AL14
■ Oro Rosa Pink Gold	V	AL17
■ Rame Copper	V	AL23
■ Ottone Brass	V	AL24
■ Umber Umber	V	AL26

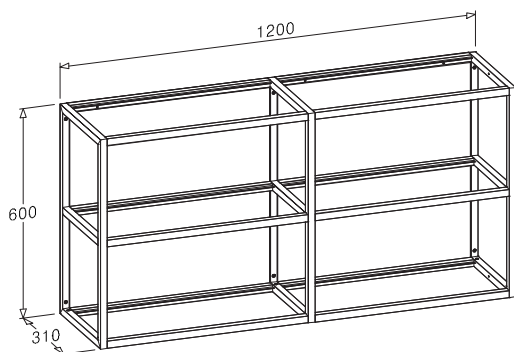

**ALTEZZA, LARGHEZZA E PROFONDITA'**  
**HEIGHT, WIDTH AND DEPTH**  
H.600 L.1200 P.310 - H.600 W.1200 D.310

**CODICE ARTICOLO E7753120**  
**ITEM NUMBER**

FINITURA FINISH	A/V*	OPZIONE COLORE COLOUR OPTION
■ Nero Black	A	AL11
■ Titanio Titanium	A	AL12
■ Selce Flint Grey	V	AL13
■ Silver Dark Dark Silver	V	AL14
■ Oro Rosa Pink Gold	V	AL17
■ Rame Copper	V	AL23
■ Ottone Brass	V	AL24
■ Umber Umber	V	AL26

# Pensili H 600

Wall Units

\*A/V: A=ANODIZZATO V=VERNICIATO  
ANODIZED PAINTED

**N.B.: PER I COLORI DELLE SCHIENE VEDI PAG:74-77**  
**NOTE: FOR THE BACK PANEL COLORS SEE PAGE 74-77**

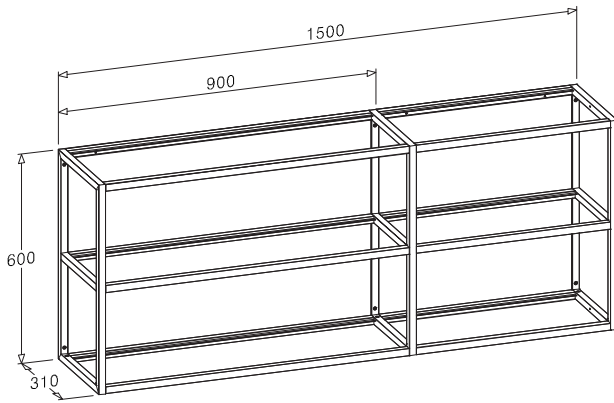

**VERSO DX**  
**TO THE RIGHT**

## ALTEZZA, LARGHEZZA E PROFONDITA'

HEIGHT, WIDTH AND DEPTH

H.600 L.1500 P.310 - H.600 W.1500 D.310

**CODICE ARTICOLO E7753151**  
**ITEM NUMBER**

FINITURA FINISH	A/V*	OPZIONE COLORE COLOUR OPTION
<b>Nero</b> Black	A	AL11
<b>Titanio</b> Titanium	A	AL12
<b>Selce</b> Flint Grey	V	AL13
<b>Silver Dark</b> Dark Silver	V	AL14
<b>Oro Rosa</b> Pink Gold	V	AL17
<b>Rame</b> Copper	V	AL23
<b>Ottone</b> Brass	V	AL24
<b>Umber</b> Umber	V	AL26

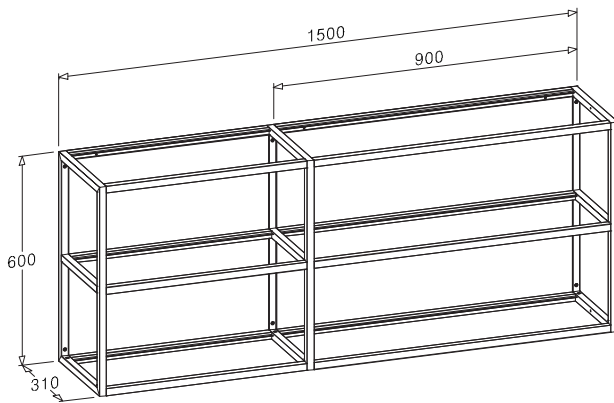

**VERSO SX**  
**TO THE LEFT**

## ALTEZZA, LARGHEZZA E PROFONDITA'

HEIGHT, WIDTH AND DEPTH

H.600 L.1500 P.310 - H.600 W.1500 D.310

**CODICE ARTICOLO E7753152**  
**ITEM NUMBER**

FINITURA FINISH	A/V*	OPZIONE COLORE COLOUR OPTION
<b>Nero</b> Black	A	AL11
<b>Titanio</b> Titanium	A	AL12
<b>Selce</b> Flint Grey	V	AL13
<b>Silver Dark</b> Dark Silver	V	AL14
<b>Oro Rosa</b> Pink Gold	V	AL17
<b>Rame</b> Copper	V	AL23
<b>Ottone</b> Brass	V	AL24
<b>Umber</b> Umber	V	AL26

## FINITURE PER RIPIANI VETRO

FINISHES FOR GLASS SHELVES

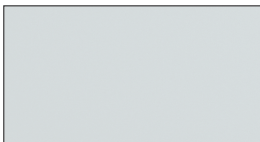

**VETRO TRASPARENTE**  
**TRANSPARENT GLASS**



**VETRO FUME' TRASPARENTE**  
**TRANSPARENT SMOKED GLASS**



**VETRO BRONZO TRASPARENTE**  
**TRANSPARENT BRONZE GLASS**

---

# Pensili alti con schienale in lamiera e ripiani vetro

## Tall wall units with sheet metal back panel and glass shelves

---

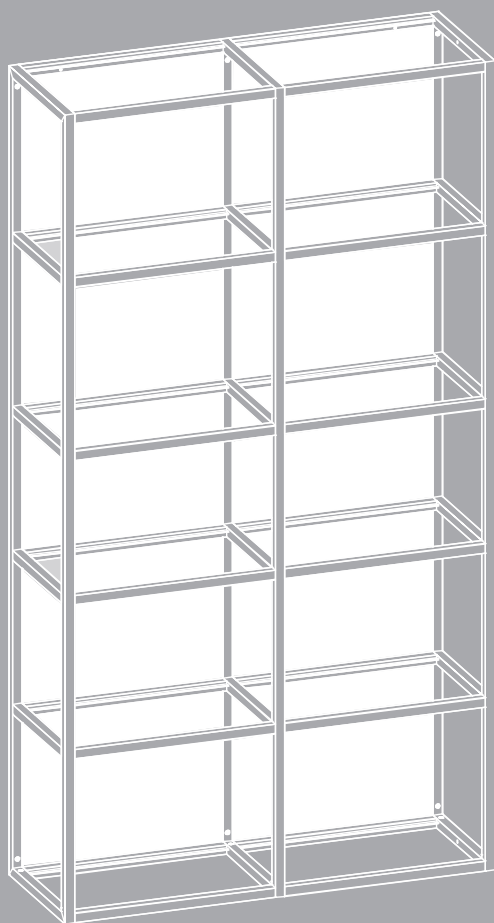

# Pensili H 720

## Wall Units

\*A/V: A=ANODIZZATO V=VERNICIATO  
ANODIZED PAINTED

CON SCHIENALE  
WITH BACK PANEL

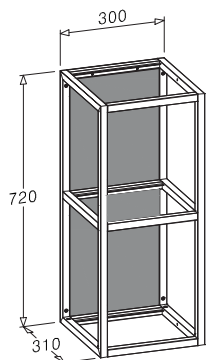

### ALTEZZA, LARGHEZZA E PROFONDITA'

HEIGHT, WIDTH AND DEPTH  
H.720 L.300 P.310 - H.720 W.300 D.310

**CODICE ARTICOLO** E7804030  
ITEM NUMBER

FINITURA FINISH	A/V*	OPZIONE COLORE COLOUR OPTION
■ <b>Nero</b> Black	A	AL11
■ <b>Titanio</b> Titanium	A	AL12
■ <b>Selce</b> Flint Grey	V	AL13
■ <b>Silver Dark</b> Dark Silver	V	AL14
■ <b>Oro Rosa</b> Pink Gold	V	AL17
■ <b>Rame</b> Copper	V	AL23
■ <b>Ottone</b> Brass	V	AL24
■ <b>Umber</b> Umber	V	AL26

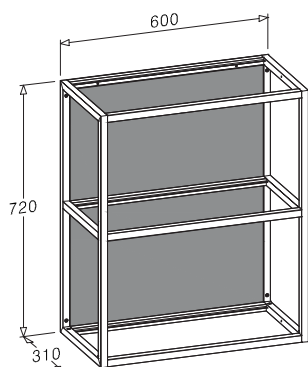

### ALTEZZA, LARGHEZZA E PROFONDITA'

HEIGHT, WIDTH AND DEPTH  
H.720 L.600 P.310 - H.720 W.600 D.310

**CODICE ARTICOLO** E7804060  
ITEM NUMBER

FINITURA FINISH	A/V*	OPZIONE COLORE COLOUR OPTION
■ <b>Nero</b> Black	A	AL11
■ <b>Titanio</b> Titanium	A	AL12
■ <b>Selce</b> Flint Grey	V	AL13
■ <b>Silver Dark</b> Dark Silver	V	AL14
■ <b>Oro Rosa</b> Pink Gold	V	AL17
■ <b>Rame</b> Copper	V	AL23
■ <b>Ottone</b> Brass	V	AL24
■ <b>Umber</b> Umber	V	AL26

**Pensili H 960**  
Wall Units

\*A/V: A=ANODIZZATO V=VERNICIATO  
ANODIZED PAINTED

CON SCHIENALE  
WITH BACK PANEL

**ALTEZZA, LARGHEZZA E PROFONDITA'**

**HEIGHT, WIDTH AND DEPTH**

H.960 L.300 P.310 - H.960 W.300 D.310

**CODICE ARTICOLO** E7805030  
**ITEM NUMBER**

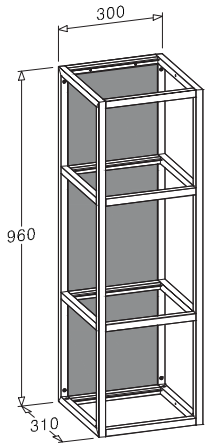

FINITURA FINISH	A/V*	OPZIONE COLORE COLOUR OPTION
<b>Nero</b> Black	A	AL11
<b>Titanio</b> Titanium	A	AL12
<b>Selce</b> Flint Grey	V	AL13
<b>Silver Dark</b> Dark Silver	V	AL14
<b>Oro Rosa</b> Pink Gold	V	AL17
<b>Rame</b> Copper	V	AL23
<b>Ottone</b> Brass	V	AL24
<b>Umber</b> Umber	V	AL26

**ALTEZZA, LARGHEZZA E PROFONDITA'**

**HEIGHT, WIDTH AND DEPTH**

H.960 L.600 P.310 - H.960 W.600 D.310

**CODICE ARTICOLO** E7805060  
**ITEM NUMBER**

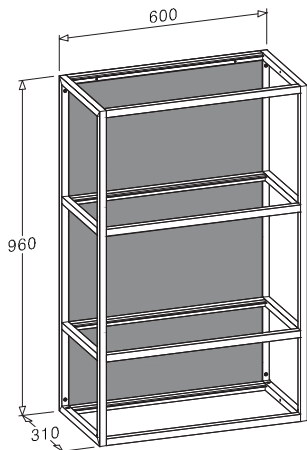

FINITURA FINISH	A/V*	OPZIONE COLORE COLOUR OPTION
<b>Nero</b> Black	A	AL11
<b>Titanio</b> Titanium	A	AL12
<b>Selce</b> Flint Grey	V	AL13
<b>Silver Dark</b> Dark Silver	V	AL14
<b>Oro Rosa</b> Pink Gold	V	AL17
<b>Rame</b> Copper	V	AL23
<b>Ottone</b> Brass	V	AL24
<b>Umber</b> Umber	V	AL26

**FINITURE PER RIPIANI VETRO**  
**FINISHES FOR GLASS SHELVES**

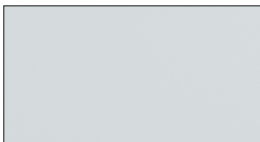

**VETRO TRASPARENTE**  
**TRANSPARENT GLASS**



**VETRO FUME' TRASPARENTE**  
**TRANSPARENT SMOKED GLASS**



**VETRO BRONZO TRASPARENTE**  
**TRANSPARENT BRONZE GLASS**



**Pensili H 1020**  
Wall Units

**\*A/V:** A=ANODIZZATO V=VERNICIATO  
ANODIZED PAINTED

CON SCHIENALE  
WITH BACK PANEL

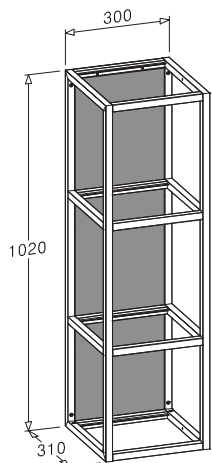

**ALTEZZA, LARGHEZZA E PROFONDITA'**  
**HEIGHT, WIDTH AND DEPTH**  
H.1020 L.300 P.310 - H.1020 W.300 D.310

**CODICE ARTICOLO** E7806030  
**ITEM NUMBER**

<b>FINITURA</b> <b>FINISH</b>	<b>A/V*</b>	<b>OPZIONE COLORE</b> <b>COLOUR OPTION</b>
■ <b>Nero</b> Black	A	AL11
■ <b>Titanio</b> Titanium	A	AL12
■ <b>Selce</b> Flint Grey	V	AL13
■ <b>Silver Dark</b> Dark Silver	V	AL14
■ <b>Oro Rosa</b> Pink Gold	V	AL17
■ <b>Rame</b> Copper	V	AL23
■ <b>Ottone</b> Brass	V	AL24
■ <b>Umber</b> Umber	V	AL26

# Pensili H 1320

Wall Units

\*A/V: A=ANODIZZATO V=VERNICIATO  
ANODIZED PAINTED

CON SCHIENALE  
WITH BACK PANEL

## ALTEZZA, LARGHEZZA E PROFONDITA'

HEIGHT, WIDTH AND DEPTH

H.1320 L.300 P.310 - H.1320 W.300 D.310

**CODICE ARTICOLO E7806160**

ITEM NUMBER

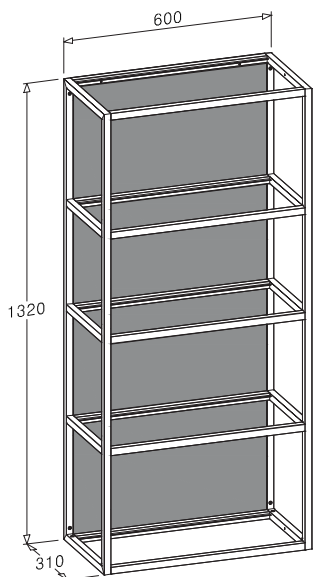

FINITURA FINISH	A/V*	OPZIONE COLORE COLOUR OPTION
■ Nero Black	A	AL11
■ Titanio Titanium	A	AL12
■ Selce Flint Grey	V	AL13
■ Silver Dark Dark Silver	V	AL14
■ Oro Rosa Pink Gold	V	AL17
■ Rame Copper	V	AL23
■ Ottone Brass	V	AL24
■ Umber Umber	V	AL26

## FINITURE PER RIPIANI VETRO

FINISHES FOR GLASS SHELVES

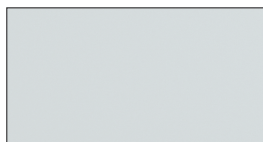

**VETRO TRASPARENTE**  
TRANSPARENT GLASS



**VETRO FUME' TRASPARENTE**  
TRANSPARENT SMOKED GLASS



**VETRO BRONZO TRASPARENTE**  
TRANSPARENT BRONZE GLASS

**Pensili H 1680**  
Wall Units

\*A/V: A=ANODIZZATO V=VERNICIATO  
ANODIZED PAINTED

CON SCHIENALE  
WITH BACK PANEL

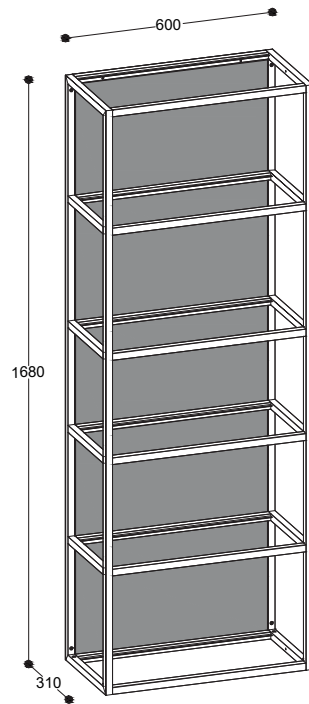
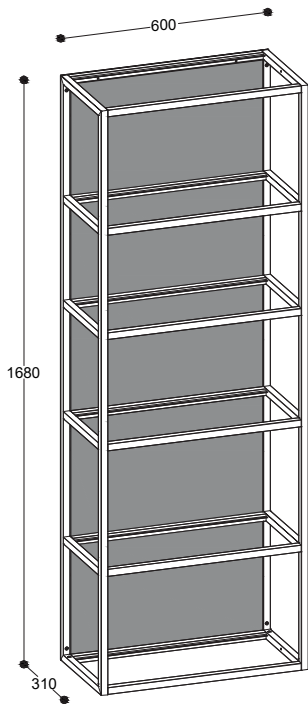

**ALTEZZA, LARGHEZZA E PROFONDITA'**  
**HEIGHT, WIDTH AND DEPTH**  
H.1680 L.600 P.310 - H.1680 W.600 D.310

**CODICE ARTICOLO E7807060**  
**ITEM NUMBER**

FINITURA FINISH	A/V*	OPZIONE COLORE COLOUR OPTION
■ Nero Black	A	AL11
■ Titanio Titanium	A	AL12
■ Selce Flint Grey	V	AL13
■ Silver Dark Dark Silver	V	AL14
■ Oro Rosa Pink Gold	V	AL17
■ Rame Copper	V	AL23
■ Ottone Brass	V	AL24
■ Umber Umber	V	AL26

**ALTEZZA, LARGHEZZA E PROFONDITA'**  
**HEIGHT, WIDTH AND DEPTH**  
H.1680 L.600 P.310 - H.1680 W.600 D.310

**RIALZATO RAISED**  
**CODICE ARTICOLO E7807063**  
**ITEM NUMBER**

**PER ALLINEAMENTO UTILIZZARE**  
**MODULO H 36 (vedi pag.79-80)**  
**FOR ALIGNMENT USE**  
**MODULE H 36 (see page 79-80)**

**RIALZATO**  
**PER ALLINEAMENTO UTILIZZARE**  
**MODULO H 72 (vedi pag.79-80)**  
**RAISED**  
**FOR ALIGNMENT USE**  
**MODULE H 72 (see page 79-80)**

FINITURA FINISH	A/V*	OPZIONE COLORE COLOUR OPTION
■ Nero Black	A	AL11
■ Titanio Titanium	A	AL12
■ Selce Flint Grey	V	AL13
■ Silver Dark Dark Silver	V	AL14
■ Oro Rosa Pink Gold	V	AL17
■ Rame Copper	V	AL23
■ Ottone Brass	V	AL24
■ Umber Umber	V	AL26

**ALTEZZA, LARGHEZZA E PROFONDITA'**  
**HEIGHT, WIDTH AND DEPTH**  
H.1680 L.900 P.310 - H.1680 W.900 D.310

**CODICE ARTICOLO E7807090**  
**ITEM NUMBER**

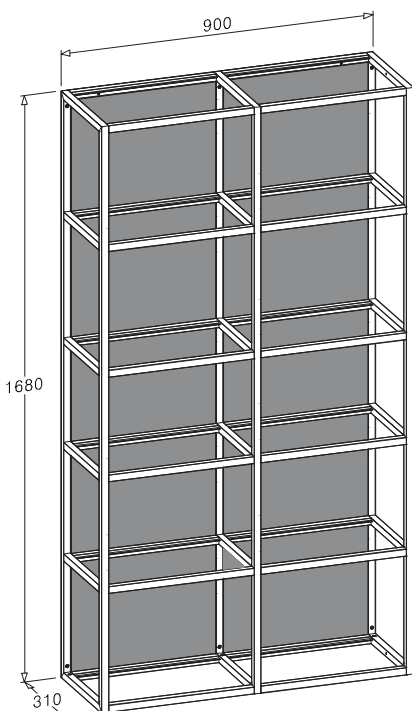

FINITURA FINISH	A/V*	OPZIONE COLORE COLOUR OPTION
■ Nero Black	A	AL11
■ Titanio Titanium	A	AL12
■ Selce Flint Grey	V	AL13
■ Silver Dark Dark Silver	V	AL14
■ Oro Rosa Pink Gold	V	AL17
■ Rame Copper	V	AL23
■ Ottone Brass	V	AL24
■ Umber Umber	V	AL26

# Pensili H 2040

Wall Units

\*A/V: A=ANODIZZATO V=VERNICIATO  
ANODIZED PAINTED

CON SCHIENALE  
WITH BACK PANEL

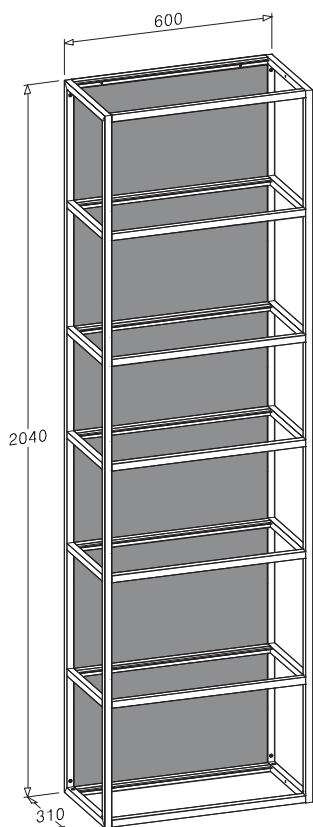

## ALTEZZA, LARGHEZZA E PROFONDITA'

HEIGHT, WIDTH AND DEPTH

H.2040 L.600 P.310 - H.2040 W.600 D.310

**CODICE ARTICOLO E7838060**

ITEM NUMBER

FINITURA FINISH	A/V*	OPZIONE COLORE COLOUR OPTION
■ Nero Black	A	AL11
■ Titanio Titanium	A	AL12
■ Selce Flint Grey	V	AL13
■ Silver Dark Dark Silver	V	AL14
■ Oro Rosa Pink Gold	V	AL17
■ Rame Copper	V	AL23
■ Ottone Brass	V	AL24
■ Umber Umber	V	AL26

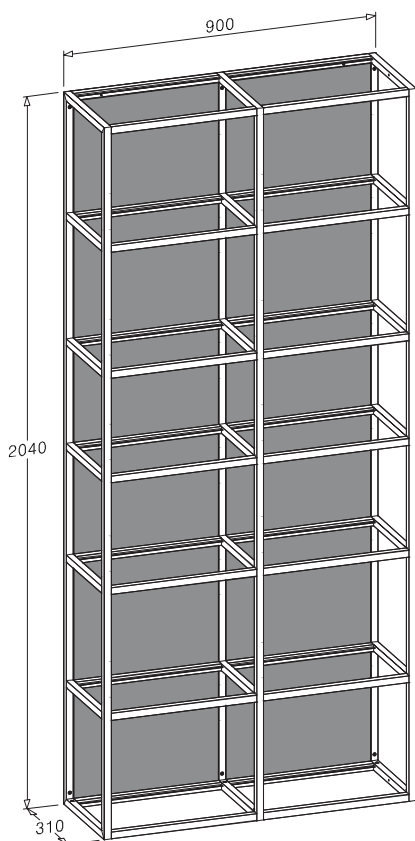

## ALTEZZA, LARGHEZZA E PROFONDITA'

HEIGHT, WIDTH AND DEPTH

H.2040 L.900 P.310 - H.2040 W.900 D.310

**CODICE ARTICOLO E7838090**

ITEM NUMBER

FINITURA FINISH	A/V*	OPZIONE COLORE COLOUR OPTION
■ Nero Black	A	AL11
■ Titanio Titanium	A	AL12
■ Selce Flint Grey	V	AL13
■ Silver Dark Dark Silver	V	AL14
■ Oro Rosa Pink Gold	V	AL17
■ Rame Copper	V	AL23
■ Ottone Brass	V	AL24
■ Umber Umber	V	AL26

## FINITURE PER RIPIANI VETRO

FINISHES FOR GLASS SHELVES

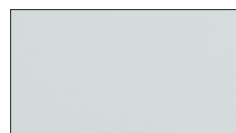

**VETRO TRASPARENTE**  
TRANSPARENT GLASS



**VETRO FUME' TRASPARENTE**  
TRANSPARENT SMOKED GLASS



**VETRO BRONZO TRASPARENTE**  
TRANSPARENT BRONZE GLASS

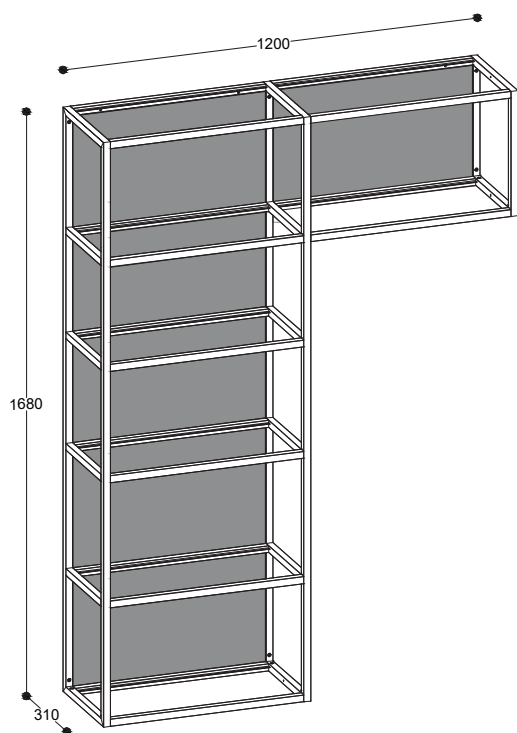

**VERSO DX (esempio di utilizzo vedi pag.79-80)**  
**TO THE RIGHT (example of use see page 79-80)**

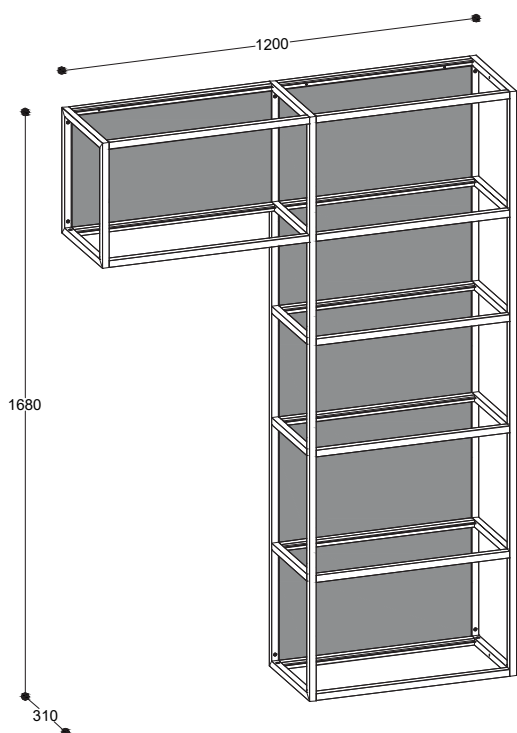

**VERSO SX (esempio di utilizzo vedi pag.79-80)**  
**TO THE LEFT (example of use see page 79-80)**

**ALTEZZA, LARGHEZZA E PROFONDITA'**  
**HEIGHT, WIDTH AND DEPTH**  
H.1680 L.1200 P.310 - H.1680 W.1200 D.310

**CODICE ARTICOLO E7807121**  
**ITEM NUMBER**

FINITURA FINISH	A/V*	OPZIONE COLORE COLOUR OPTION
■ <b>Nero</b> Black	A	AL11
■ <b>Titanio</b> Titanium	A	AL12
■ <b>Selce</b> Flint Grey	V	AL13
■ <b>Silver Dark</b> Dark Silver	V	AL14
■ <b>Oro Rosa</b> Pink Gold	V	AL17
■ <b>Rame</b> Copper	V	AL23
■ <b>Ottone</b> Brass	V	AL24
■ <b>Umber</b> Umber	V	AL26

**ALTEZZA, LARGHEZZA E PROFONDITA'**  
**HEIGHT, WIDTH AND DEPTH**  
H.1680 L.1200 P.310 - H.1680 W.1200 D.310

**CODICE ARTICOLO E7807122**  
**ITEM NUMBER**

FINITURA FINISH	A/V*	OPZIONE COLORE COLOUR OPTION
■ <b>Nero</b> Black	A	AL11
■ <b>Titanio</b> Titanium	A	AL12
■ <b>Selce</b> Flint Grey	V	AL13
■ <b>Silver Dark</b> Dark Silver	V	AL14
■ <b>Oro Rosa</b> Pink Gold	V	AL17
■ <b>Rame</b> Copper	V	AL23
■ <b>Ottone</b> Brass	V	AL24
■ <b>Umber</b> Umber	V	AL26

Elementi sottopenisola H 480  
Under-peninsula elements

\*A/V: A=ANODIZZATO V=VERNICIATO  
ANODIZED PAINTED

CON SCHIENALE  
WITH BACK PANEL

ALTEZZA, LARGHEZZA E PROFONDITA'  
HEIGHT, WIDTH AND DEPTH  
H.480 L.600 P.310 - H.480 W.600 D.310

CODICE ARTICOLO E7822060  
ITEM NUMBER

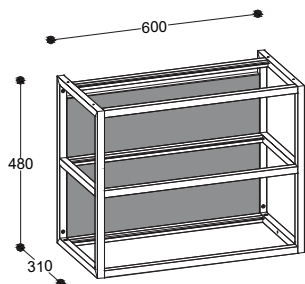

FINITURA FINISH	A/V*	OPZIONE COLORE COLOUR OPTION
<b>Nero</b> Black	A	AL11
<b>Titanio</b> Titanium	A	AL12
<b>Selce</b> Flint Grey	V	AL13
<b>Silver Dark</b> Dark Silver	V	AL14
<b>Oro Rosa</b> Pink Gold	V	AL17
<b>Rame</b> Copper	V	AL23
<b>Ottone</b> Brass	V	AL24
<b>Umber</b> Umber	V	AL26

ALTEZZA, LARGHEZZA E PROFONDITA'  
HEIGHT, WIDTH AND DEPTH  
H.480 L.900 P.310 - H.480 W.900 D.310

CODICE ARTICOLO E7822090  
ITEM NUMBER

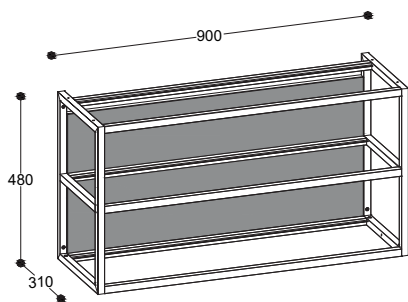

FINITURA FINISH	A/V*	OPZIONE COLORE COLOUR OPTION
<b>Nero</b> Black	A	AL11
<b>Titanio</b> Titanium	A	AL12
<b>Selce</b> Flint Grey	V	AL13
<b>Silver Dark</b> Dark Silver	V	AL14
<b>Oro Rosa</b> Pink Gold	V	AL17
<b>Rame</b> Copper	V	AL23
<b>Ottone</b> Brass	V	AL24
<b>Umber</b> Umber	V	AL26

FINITURE PER RIPIANI VETRO  
FINISHES FOR GLASS SHELVES

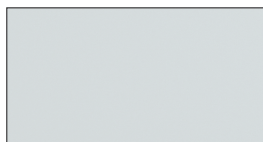

VETRO TRASPARENTE  
TRANSPARENT GLASS



VETRO FUME' TRASPARENTE  
TRANSPARENT SMOKED GLASS



VETRO BRONZO TRASPARENTE  
TRANSPARENT BRONZE GLASS

---

# Pensili alti con schiena personalizzata e ripiani vetro

## Tall wall units with personalized back panel and glass shelves

---

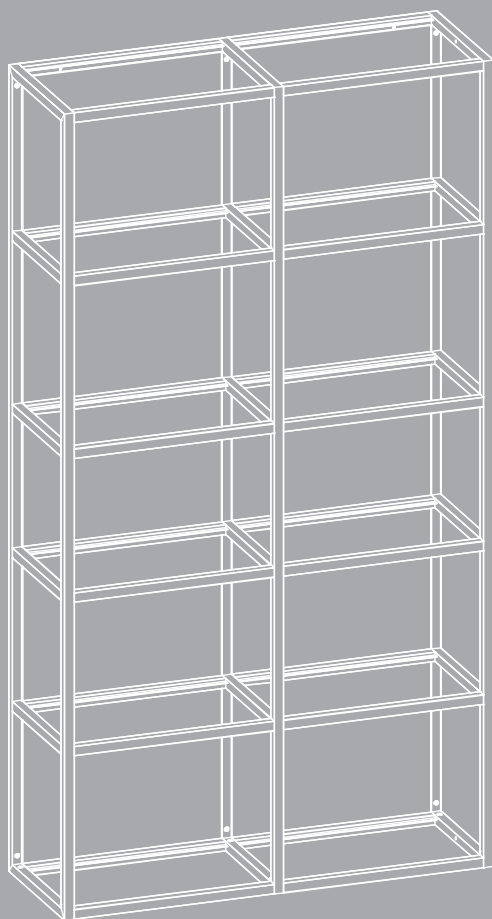

# Pensili H 720

## Wall Units

\*A/V: A=ANODIZZATO V=VERNICIATO  
ANODIZED PAINTED

**N.B.: PER I COLORI DELLE SCHIENE VEDI PAG:74-77**  
**NOTE: FOR THE BACK PANEL COLORS SEE PAGE 74-77**

### ALTEZZA, LARGHEZZA E PROFONDITA'

#### HEIGHT, WIDTH AND DEPTH

H.720 L.300 P.310 - H.720 W.300 D.310

**CODICE ARTICOLO E7754030**

ITEM NUMBER

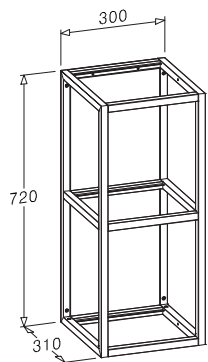

FINITURA FINISH	A/V*	OPZIONE COLORE COLOUR OPTION
■ <b>Nero</b> Black	A	AL11
■ <b>Titanio</b> Titanium	A	AL12
■ <b>Selce</b> Flint Grey	V	AL13
■ <b>Silver Dark</b> Dark Silver	V	AL14
■ <b>Oro Rosa</b> Pink Gold	V	AL17
■ <b>Rame</b> Copper	V	AL23
■ <b>Ottone</b> Brass	V	AL24
■ <b>Umber</b> Umber	V	AL26

### ALTEZZA, LARGHEZZA E PROFONDITA'

#### HEIGHT, WIDTH AND DEPTH

H.720 L.600 P.310 - H.720 W.600 D.310

**CODICE ARTICOLO E7754060**

ITEM NUMBER

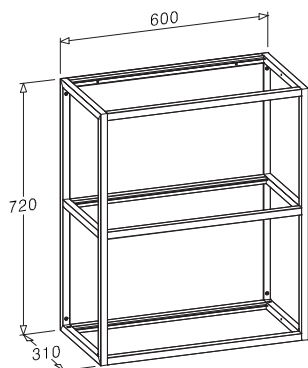

FINITURA FINISH	A/V*	OPZIONE COLORE COLOUR OPTION
■ <b>Nero</b> Black	A	AL11
■ <b>Titanio</b> Titanium	A	AL12
■ <b>Selce</b> Flint Grey	V	AL13
■ <b>Silver Dark</b> Dark Silver	V	AL14
■ <b>Oro Rosa</b> Pink Gold	V	AL17
■ <b>Rame</b> Copper	V	AL23
■ <b>Ottone</b> Brass	V	AL24
■ <b>Umber</b> Umber	V	AL26



# Pensili H 960

## Wall Units

\*A/V: A=ANODIZZATO V=VERNICIATO  
ANODIZED PAINTED

**N.B.: PER I COLORI DELLE SCHIENE VEDI PAG:74-77**  
**NOTE: FOR THE BACK PANEL COLORS SEE PAGE 74-77**

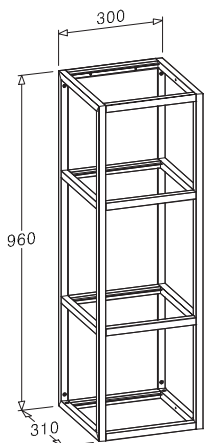

### ALTEZZA, LARGHEZZA E PROFONDITA'

#### HEIGHT, WIDTH AND DEPTH

H.960 L.300 P.310 - H.960 W.300 D.310

### CODICE ARTICOLO E7755030

#### ITEM NUMBER

FINITURA FINISH	A/V*	OPZIONE COLORE COLOUR OPTION
■ Nero Black	A	AL11
■ Titanio Titanium	A	AL12
■ Selce Flint Grey	V	AL13
■ Silver Dark Dark Silver	V	AL14
■ Oro Rosa Pink Gold	V	AL17
■ Rame Copper	V	AL23
■ Ottone Brass	V	AL24
■ Umber Umber	V	AL26

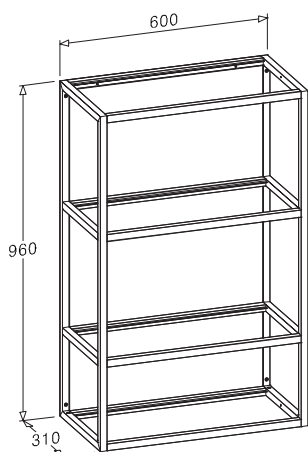

### ALTEZZA, LARGHEZZA E PROFONDITA'

#### HEIGHT, WIDTH AND DEPTH

H.960 L.600 P.310 - H.960 W.600 D.310

### CODICE ARTICOLO E7755060

#### ITEM NUMBER

FINITURA FINISH	A/V*	OPZIONE COLORE COLOUR OPTION
■ Nero Black	A	AL11
■ Titanio Titanium	A	AL12
■ Selce Flint Grey	V	AL13
■ Silver Dark Dark Silver	V	AL14
■ Oro Rosa Pink Gold	V	AL17
■ Rame Copper	V	AL23
■ Ottone Brass	V	AL24
■ Umber Umber	V	AL26

### FINITURE PER RIPIANI VETRO

#### FINISHES FOR GLASS SHELVES

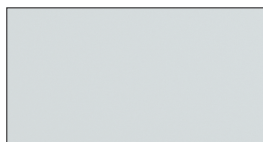

**VETRO TRASPARENTE**  
TRANSPARENT GLASS



**VETRO FUME' TRASPARENTE**  
TRANSPARENT SMOKED GLASS



**VETRO BRONZO TRASPARENTE**  
TRANSPARENT BRONZE GLASS

**Pensili H 1020**  
Wall Units

**\*A/V:** A=ANODIZZATO V=VERNICIATO  
ANODIZED PAINTED

**N.B.: PER I COLORI DELLE SCHIENE VEDI PAG:74-77**  
**NOTE: FOR THE BACK PANEL COLORS SEE PAGE 74-77**

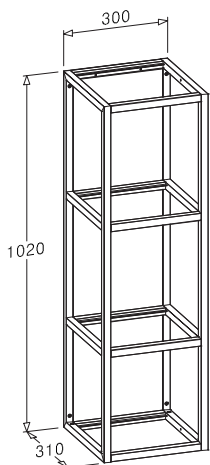

**ALTEZZA, LARGHEZZA E PROFONDITA'**  
**HEIGHT, WIDTH AND DEPTH**  
H.1020 L.300 P.310 - H.1020 W.300 D.310

**CODICE ARTICOLO E7756030**  
**ITEM NUMBER**

FINITURA FINISH	A/V*	OPZIONE COLORE COLOUR OPTION
■ <b>Nero</b> Black	A	AL11
■ <b>Titanio</b> Titanium	A	AL12
■ <b>Selce</b> Flint Grey	V	AL13
■ <b>Silver Dark</b> Dark Silver	V	AL14
■ <b>Oro Rosa</b> Pink Gold	V	AL17
■ <b>Rame</b> Copper	V	AL23
■ <b>Ottone</b> Brass	V	AL24
■ <b>Umber</b> Umber	V	AL26

# Pensili H 1320

Wall Units

\*A/V: A=ANODIZZATO V=VERNICIATO  
ANODIZED PAINTED

**N.B.: PER I COLORI DELLE SCHIENE VEDI PAG:74-77**  
**NOTE: FOR THE BACK PANEL COLORS SEE PAGE 74-77**

## ALTEZZA, LARGHEZZA E PROFONDITA'

HEIGHT, WIDTH AND DEPTH

H.1320 L.600 P.310 - H.1320 W.600 D.310

**CODICE ARTICOLO E7756160**

ITEM NUMBER

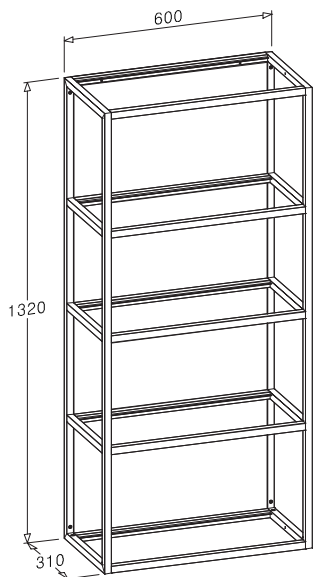

FINITURA FINISH	A/V*	OPZIONE COLORE COLOUR OPTION
■ <b>Nero</b> Black	A	AL11
■ <b>Titanio</b> Titanium	A	AL12
■ <b>Selce</b> Flint Grey	V	AL13
■ <b>Silver Dark</b> Dark Silver	V	AL14
■ <b>Oro Rosa</b> Pink Gold	V	AL17
■ <b>Rame</b> Copper	V	AL23
■ <b>Ottone</b> Brass	V	AL24
■ <b>Umber</b> Umber	V	AL26

## FINITURE PER RIPIANI VETRO

FINISHES FOR GLASS SHELVES

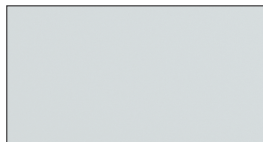

**VETRO TRASPARENTE**  
TRANSPARENT GLASS



**VETRO FUME' TRASPARENTE**  
TRANSPARENT SMOKED GLASS



**VETRO BRONZO TRASPARENTE**  
TRANSPARENT BRONZE GLASS

# Pensili H 1680

Wall Units

\*A/V: A=ANODIZZATO V=VERNICIATO  
ANODIZED PAINTED

**N.B.: PER I COLORI DELLE SCHIENE VEDI PAG:74-77**  
**NOTE: FOR THE BACK PANEL COLORS SEE PAGE 74-77**

## ALTEZZA, LARGHEZZA E PROFONDITA'

HEIGHT, WIDTH AND DEPTH

H.1680 L.600 P.310 - H.1680 W.600 D.310

**CODICE ARTICOLO E7757060**

ITEM NUMBER

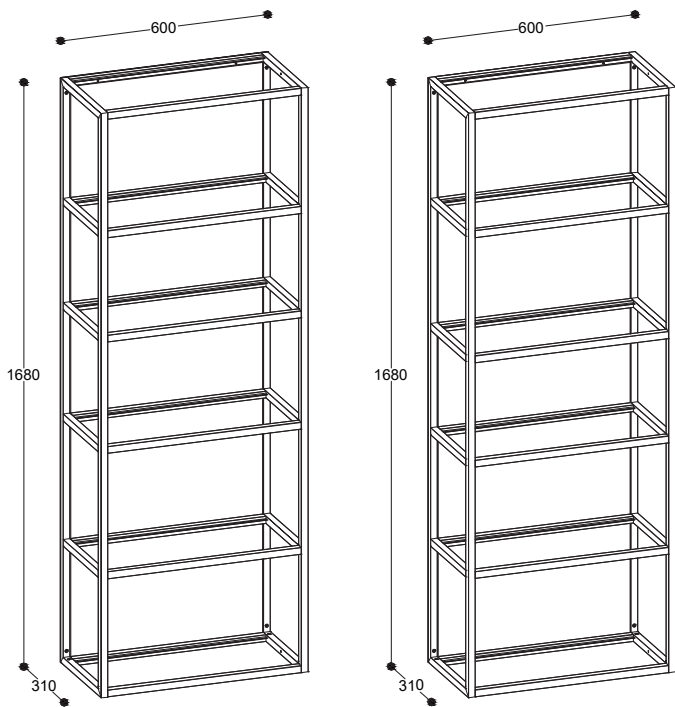

FINITURA FINISH	A/V*	OPZIONE COLORE COLOUR OPTION
<b>Nero</b> Black	A	AL11
<b>Titanio</b> Titanium	A	AL12
<b>Selce</b> Flint Grey	V	AL13
<b>Silver Dark</b> Dark Silver	V	AL14
<b>Oro Rosa</b> Pink Gold	V	AL17
<b>Rame</b> Copper	V	AL23
<b>Ottone</b> Brass	V	AL24
<b>Umber</b> Umber	V	AL26

## ALTEZZA, LARGHEZZA E PROFONDITA'

HEIGHT, WIDTH AND DEPTH

H.1680 L.600 P.310 - H.1680 W.600 D.310

**RIALZATO RAISED**

**CODICE ARTICOLO E7757063**

ITEM NUMBER

**PER ALLINEAMENTO UTILIZZARE  
MODULO H 36 (vedi pag.79-80)  
FOR ALIGNMENT USE  
MODULE H 36 (see page 79-80)**

**RIALZATO  
PER ALLINEAMENTO UTILIZZARE  
MODULO H 72 (vedi pag.79-80)  
RAISED  
FOR ALIGNMENT USE  
MODULE H 72 (see page 79-80)**

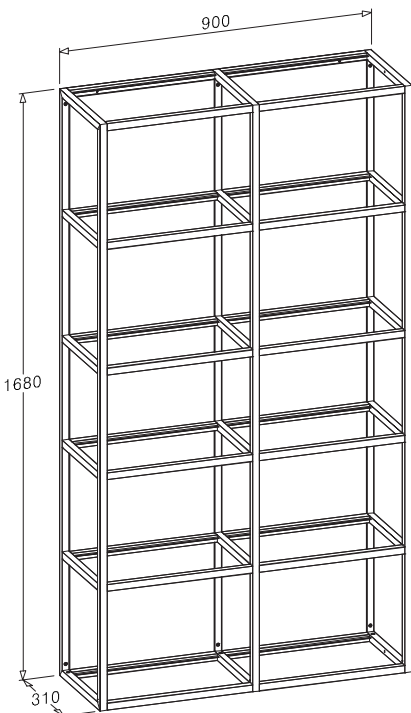

FINITURA FINISH	A/V*	OPZIONE COLORE COLOUR OPTION
<b>Nero</b> Black	A	AL11
<b>Titanio</b> Titanium	A	AL12
<b>Selce</b> Flint Grey	V	AL13
<b>Silver Dark</b> Dark Silver	V	AL14
<b>Oro Rosa</b> Pink Gold	V	AL17
<b>Rame</b> Copper	V	AL23
<b>Ottone</b> Brass	V	AL24
<b>Umber</b> Umber	V	AL26

## ALTEZZA, LARGHEZZA E PROFONDITA'

HEIGHT, WIDTH AND DEPTH

H.1680 L.900 P.310 - H.1680 W.900 D.310

**CODICE ARTICOLO E7757090**

ITEM NUMBER

FINITURA FINISH	A/V*	OPZIONE COLORE COLOUR OPTION
<b>Nero</b> Black	A	AL11
<b>Titanio</b> Titanium	A	AL12
<b>Selce</b> Flint Grey	V	AL13
<b>Silver Dark</b> Dark Silver	V	AL14
<b>Oro Rosa</b> Pink Gold	V	AL17
<b>Rame</b> Copper	V	AL23
<b>Ottone</b> Brass	V	AL24
<b>Umber</b> Umber	V	AL26

# Pensili H 2040

Wall Units

\*A/V: A=ANODIZZATO V=VERNICIATO  
ANODIZED PAINTED

**N.B.: PER I COLORI DELLE SCHIENE VEDI PAG:74-77**  
**NOTE: FOR THE BACK PANEL COLORS SEE PAGE 74-77**

## ALTEZZA, LARGHEZZA E PROFONDITA'

HEIGHT, WIDTH AND DEPTH

H.2040 L.600 P.310 - H.2040 W.600 D.310

**CODICE ARTICOLO E7788060**

ITEM NUMBER

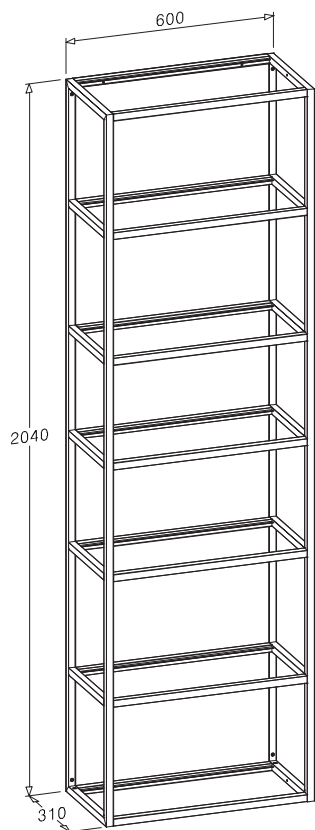

FINITURA FINISH	A/V*	OPZIONE COLORE COLOUR OPTION
■ Nero Black	A	AL11
■ Titanio Titanium	A	AL12
■ Selce Flint Grey	V	AL13
■ Silver Dark Dark Silver	V	AL14
■ Oro Rosa Pink Gold	V	AL17
■ Rame Copper	V	AL23
■ Ottone Brass	V	AL24
■ Umber	V	AL26

## ALTEZZA, LARGHEZZA E PROFONDITA'

HEIGHT, WIDTH AND DEPTH

H.2040 L.900 P.310 - H.2040 W.900 D.310

**CODICE ARTICOLO E7788090**

ITEM NUMBER

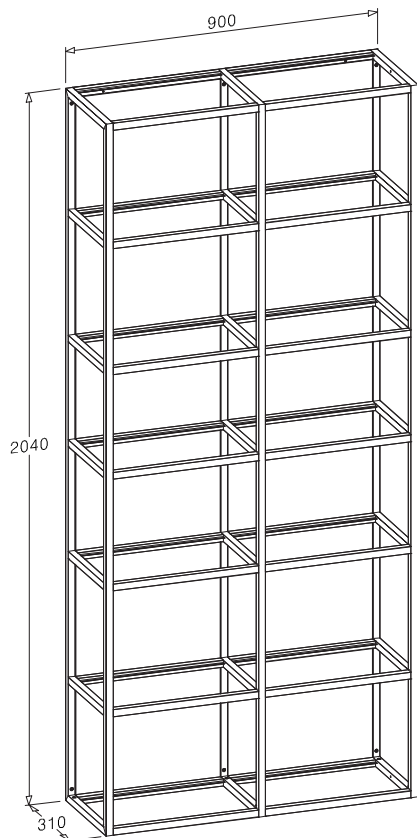

FINITURA FINISH	A/V*	OPZIONE COLORE COLOUR OPTION
■ Nero Black	A	AL11
■ Titanio Titanium	A	AL12
■ Selce Flint Grey	V	AL13
■ Silver Dark Dark Silver	V	AL14
■ Oro Rosa Pink Gold	V	AL17
■ Rame Copper	V	AL23
■ Ottone Brass	V	AL24
■ Umber	V	AL26

## FINITURE PER RIPIANI VETRO FINISHES FOR GLASS SHELVES

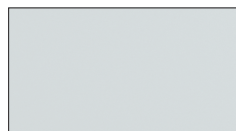

**VETRO TRASPARENTE**  
TRANSPARENT GLASS



**VETRO FUME' TRASPARENTE**  
TRANSPARENT SMOKED GLASS



**VETRO BRONZO TRASPARENTE**  
TRANSPARENT BRONZE GLASS

Pensili H 1680 elementi speciali \*A/V: A=ANODIZZATO V=VERNICIATO  
 ANODIZED PAINTED

**N.B.: PER I COLORI DELLE SCHIENE VEDI PAG:74-77**  
**NOTE: FOR THE BACK PANEL COLORS SEE PAGE 74-77**

Wall Units - Special elements

**ALTEZZA, LARGHEZZA E PROFONDITA'**  
**HEIGHT, WIDTH AND DEPTH**  
 H.1680 L.1200 P.310 - H.1680 W.1200 D.310

**CODICE ARTICOLO E7757121**  
**ITEM NUMBER**

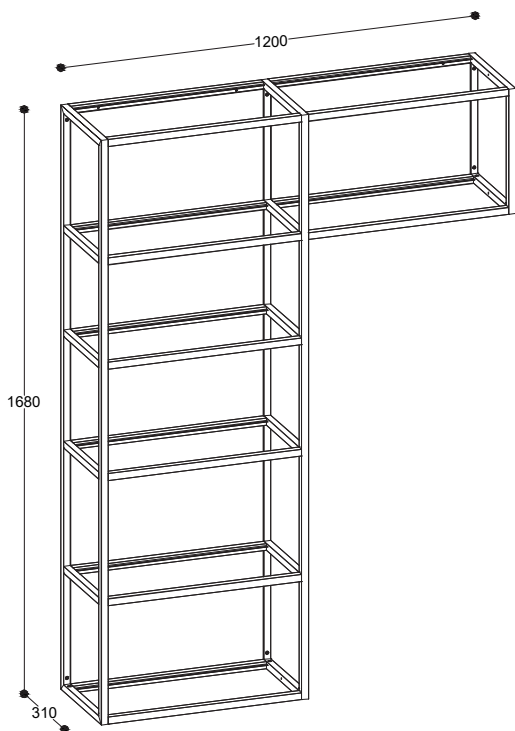

FINITURA FINISH	A/V*	OPZIONE COLORE COLOUR OPTION
■ Nero Black	A	AL11
■ Titanio Titanium	A	AL12
■ Selce Flint Grey	V	AL13
■ Silver Dark Dark Silver	V	AL14
■ Oro Rosa Pink Gold	V	AL17
■ Rame Copper	V	AL23
■ Ottone Brass	V	AL24
■ Umber	V	AL26

**VERSO DX (esempio di utilizzo vedi pag.79-80)**  
**TO THE RIGHT (example of use see page 79-80)**

**ALTEZZA, LARGHEZZA E PROFONDITA'**  
**HEIGHT, WIDTH AND DEPTH**  
 H.1680 L.1200 P.310 - H.1680 W.1200 D.310

**CODICE ARTICOLO E7757122**  
**ITEM NUMBER**

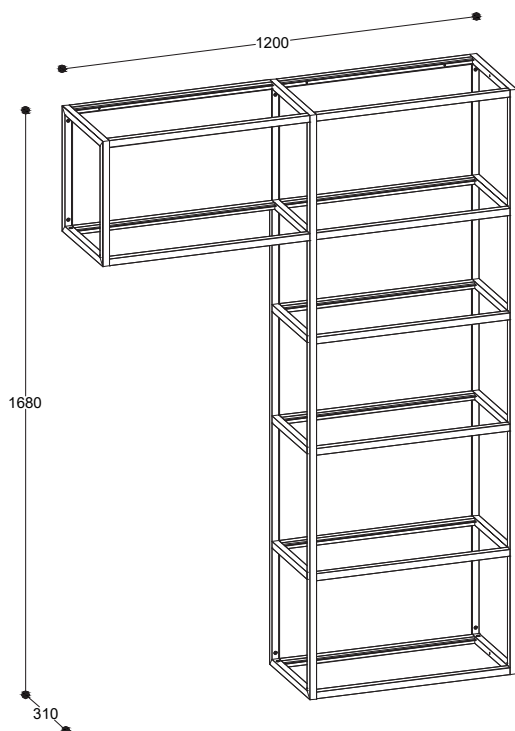

FINITURA FINISH	A/V*	OPZIONE COLORE COLOUR OPTION
■ Nero Black	A	AL11
■ Titanio Titanium	A	AL12
■ Selce Flint Grey	V	AL13
■ Silver Dark Dark Silver	V	AL14
■ Oro Rosa Pink Gold	V	AL17
■ Rame Copper	V	AL23
■ Ottone Brass	V	AL24
■ Umber	V	AL26

**VERSO SX (esempio di utilizzo vedi pag.79-80)**  
**TO THE LEFT (example of use see page 79-80)**

Elementi sottopenisola H 480  
Under-peninsula elements

\*A/V: A=ANODIZZATO V=VERNICIATO  
ANODIZED PAINTED

**N.B.: PER I COLORI DELLE SCHIENE VEDI PAG:74-77**  
**NOTE: FOR THE BACK PANEL COLORS SEE PAGE 74-77**

**ALTEZZA, LARGHEZZA E PROFONDITA'**

**HEIGHT, WIDTH AND DEPTH**

H.480 L.600 P.310 - H.480 W.600 D.310

**CODICE ARTICOLO E7772060**  
**ITEM NUMBER**

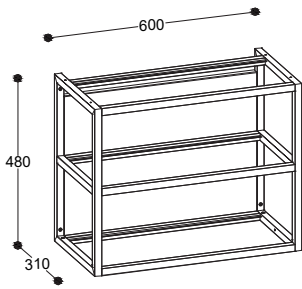

FINITURA FINISH	A/V*	OPZIONE COLORE COLOUR OPTION
<b>Nero</b> Black	A	AL11
<b>Titanio</b> Titanium	A	AL12
<b>Selce</b> Flint Grey	V	AL13
<b>Silver Dark</b> Dark Silver	V	AL14
<b>Oro Rosa</b> Pink Gold	V	AL17
<b>Rame</b> Copper	V	AL23
<b>Ottone</b> Brass	V	AL24
<b>Umber</b> Umber	V	AL26

**ALTEZZA, LARGHEZZA E PROFONDITA'**

**HEIGHT, WIDTH AND DEPTH**

H.480 L.900 P.310 - H.480 W.900 D.310

**CODICE ARTICOLO E7772090**  
**ITEM NUMBER**

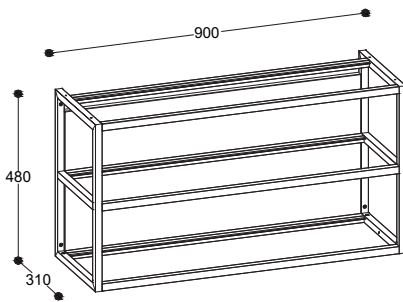

FINITURA FINISH	A/V*	OPZIONE COLORE COLOUR OPTION
<b>Nero</b> Black	A	AL11
<b>Titanio</b> Titanium	A	AL12
<b>Selce</b> Flint Grey	V	AL13
<b>Silver Dark</b> Dark Silver	V	AL14
<b>Oro Rosa</b> Pink Gold	V	AL17
<b>Rame</b> Copper	V	AL23
<b>Ottone</b> Brass	V	AL24
<b>Umber</b> Umber	V	AL26

**FINITURE PER RIPIANI VETRO**  
**FINISHES FOR GLASS SHELVES**

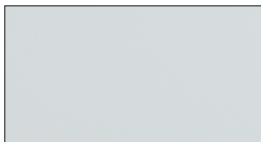

**VETRO TRASPARENTE**  
**TRANSPARENT GLASS**



**VETRO FUME' TRASPARENTE**  
**TRANSPARENT SMOKED GLASS**



**VETRO BRONZO TRASPARENTE**  
**TRANSPARENT BRONZE GLASS**

---

Pensili con schienale e fondo alluminio, ripiano vetro  
Wall units with aluminum back panel and bottom, glass shelf

---

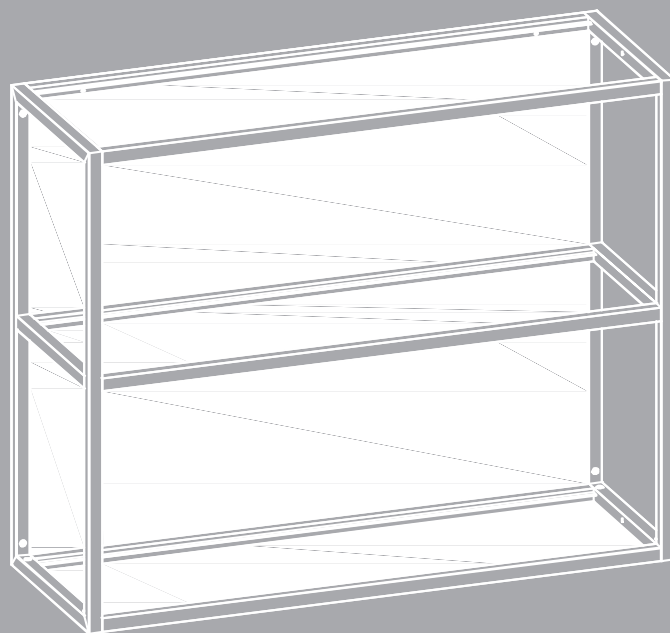



# Pensili H 240

## Wall Units

\*A/V: A=ANODIZZATO V=VERNICIATO  
ANODIZED PAINTED

CON SCHIENALE E FONDO  
WITH BACK PANEL AND BOTTOM

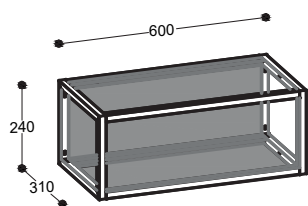

**ALTEZZA, LARGHEZZA E PROFONDITA'**  
**HEIGHT, WIDTH AND DEPTH**  
H.240 L.600 P.310 - H.240 W.600 D.310

**CODICE ARTICOLO** E7740060  
**ITEM NUMBER**

FINITURA FINISH	A/V*	OPZIONE COLORE COLOUR OPTION
■ Nero Black	A	AL11
■ Titanio Titanium	A	AL12
■ Selce Flint Grey	V	AL13
■ Silver Dark Dark Silver	V	AL14
■ Oro Rosa Pink Gold	V	AL17
■ Rame Copper	V	AL23
■ Ottone Brass	V	AL24
■ Umber Umber	V	AL26

**ALTEZZA, LARGHEZZA E PROFONDITA'**  
**HEIGHT, WIDTH AND DEPTH**  
H.240 L.900 P.310 - H.240 W.900 D.310

**CODICE ARTICOLO** E7740090  
**ITEM NUMBER**

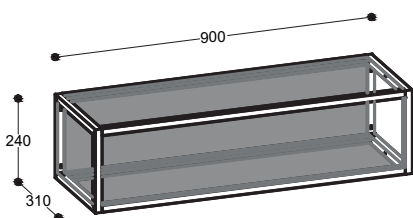

FINITURA FINISH	A/V*	OPZIONE COLORE COLOUR OPTION
■ Nero Black	A	AL11
■ Titanio Titanium	A	AL12
■ Selce Flint Grey	V	AL13
■ Silver Dark Dark Silver	V	AL14
■ Oro Rosa Pink Gold	V	AL17
■ Rame Copper	V	AL23
■ Ottone Brass	V	AL24
■ Umber Umber	V	AL26

**ALTEZZA, LARGHEZZA E PROFONDITA'**  
**HEIGHT, WIDTH AND DEPTH**  
H.240 L.1200 P.310 - H.240 W.1200 D.310

**CODICE ARTICOLO** E7740120  
**ITEM NUMBER**

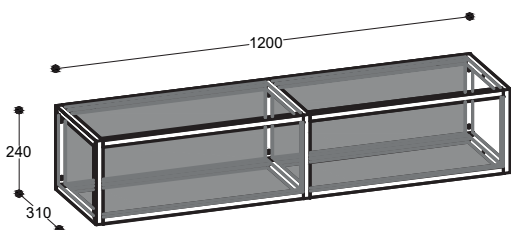

FINITURA FINISH	A/V*	OPZIONE COLORE COLOUR OPTION
■ Nero Black	A	AL11
■ Titanio Titanium	A	AL12
■ Selce Flint Grey	V	AL13
■ Silver Dark Dark Silver	V	AL14
■ Oro Rosa Pink Gold	V	AL17
■ Rame Copper	V	AL23
■ Ottone Brass	V	AL24
■ Umber Umber	V	AL26

Pensili H 240  
Wall Units

\*A/V: A=ANODIZZATO V=VERNICIATO  
ANODIZED PAINTED

CON SCHIENALE E FONDO  
WITH BACK PANEL AND BOTTOM

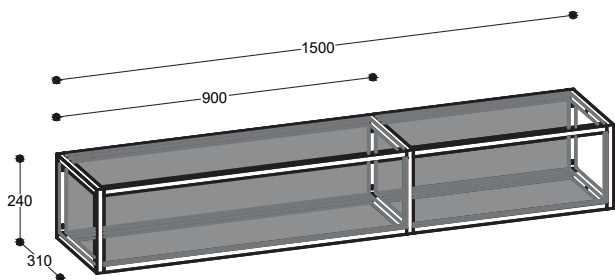

**VERSO DX  
TO THE RIGHT**

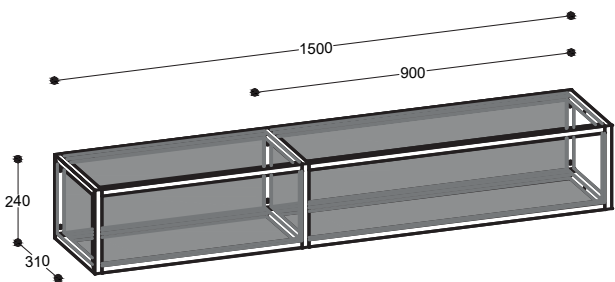

**VERSO SX  
TO THE LEFT**

**ALTEZZA, LARGHEZZA E PROFONDITA'**  
**HEIGHT, WIDTH AND DEPTH**  
H.240 L.1500 P.310 - H.240 W.1500 D.310

**CODICE ARTICOLO E7740151**  
**ITEM NUMBER**

FINITURA FINISH	A/V*	OPZIONE COLORE COLOUR OPTION
■ Nero Black	A	AL11
■ Titanio Titanium	A	AL12
■ Selce Flint Grey	V	AL13
■ Silver Dark Dark Silver	V	AL14
■ Oro Rosa Pink Gold	V	AL17
■ Rame Copper	V	AL23
■ Ottone Brass	V	AL24
■ Umber Umber	V	AL26

**ALTEZZA, LARGHEZZA E PROFONDITA'**  
**HEIGHT, WIDTH AND DEPTH**  
H.240 L.1500 P.310 - H.240 W.1500 D.310

**CODICE ARTICOLO E7740152**  
**ITEM NUMBER**

FINITURA FINISH	A/V*	OPZIONE COLORE COLOUR OPTION
■ Nero Black	A	AL11
■ Titanio Titanium	A	AL12
■ Selce Flint Grey	V	AL13
■ Silver Dark Dark Silver	V	AL14
■ Oro Rosa Pink Gold	V	AL17
■ Rame Copper	V	AL23
■ Ottone Brass	V	AL24
■ Umber Umber	V	AL26

**FINITURE PER RIPIANI VETRO**  
**FINISHES FOR GLASS SHELVES**

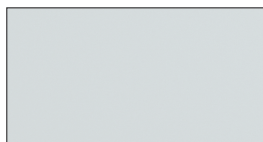

**VETRO TRASPARENTE**  
**TRANSPARENT GLASS**



**VETRO FUME' TRASPARENTE**  
**TRANSPARENT SMOKED GLASS**



**VETRO BRONZO TRASPARENTE**  
**TRANSPARENT BRONZE GLASS**

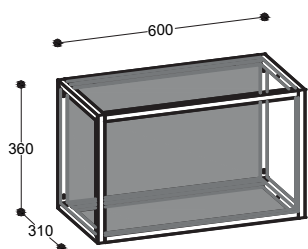

**ALTEZZA, LARGHEZZA E PROFONDITA'**  
**HEIGHT, WIDTH AND DEPTH**  
H.360 L.600 P.310 - H.360 W.600 D.310

**CODICE ARTICOLO** E7741060  
**ITEM NUMBER**

FINITURA FINISH	A/V*	OPZIONE COLORE COLOUR OPTION
<b>Nero</b> Black	A	AL11
<b>Titanio</b> Titanium	A	AL12
<b>Selce</b> Flint Grey	V	AL13
<b>Silver Dark</b> Dark Silver	V	AL14
<b>Oro Rosa</b> Pink Gold	V	AL17
<b>Rame</b> Copper	V	AL23
<b>Ottone</b> Brass	V	AL24
<b>Umber</b> Umber	V	AL26

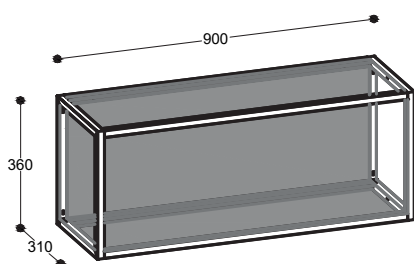

**ALTEZZA, LARGHEZZA E PROFONDITA'**  
**HEIGHT, WIDTH AND DEPTH**  
H.360 L.900 P.310 - H.360 W.900 D.310

**CODICE ARTICOLO** E7741090  
**ITEM NUMBER**

FINITURA FINISH	A/V*	OPZIONE COLORE COLOUR OPTION
<b>Nero</b> Black	A	AL11
<b>Titanio</b> Titanium	A	AL12
<b>Selce</b> Flint Grey	V	AL13
<b>Silver Dark</b> Dark Silver	V	AL14
<b>Oro Rosa</b> Pink Gold	V	AL17
<b>Rame</b> Copper	V	AL23
<b>Ottone</b> Brass	V	AL24
<b>Umber</b> Umber	V	AL26

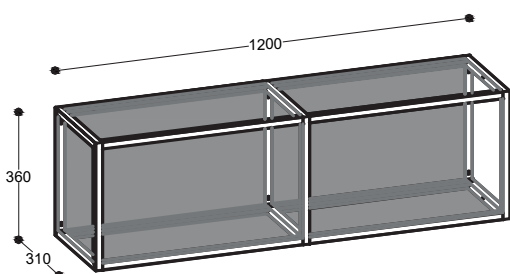

**ALTEZZA, LARGHEZZA E PROFONDITA'**  
**HEIGHT, WIDTH AND DEPTH**  
H.360 L.1200 P.310 - H.360 W.1200 D.310

**CODICE ARTICOLO** E7741120  
**ITEM NUMBER**

FINITURA FINISH	A/V*	OPZIONE COLORE COLOUR OPTION
<b>Nero</b> Black	A	AL11
<b>Titanio</b> Titanium	A	AL12
<b>Selce</b> Flint Grey	V	AL13
<b>Silver Dark</b> Dark Silver	V	AL14
<b>Oro Rosa</b> Pink Gold	V	AL17
<b>Rame</b> Copper	V	AL23
<b>Ottone</b> Brass	V	AL24
<b>Umber</b> Umber	V	AL26

Pensili H 360  
Wall Units

\*A/V: A=ANODIZZATO V=VERNICIATO  
ANODIZED PAINTED

CON SCHIENALE E FONDO  
WITH BACK PANEL AND BOTTOM

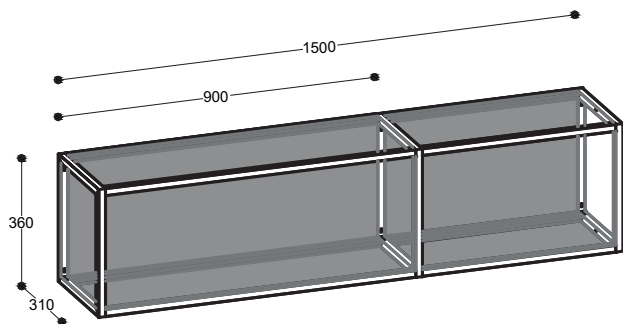

**VERSO DX  
TO THE RIGHT**

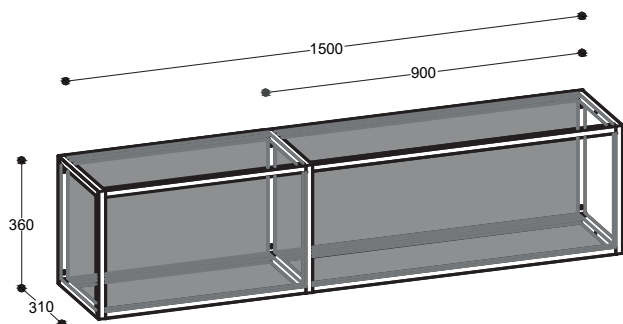

**VERSO SX  
TO THE LEFT**

**ALTEZZA, LARGHEZZA E PROFONDITA'**  
**HEIGHT, WIDTH AND DEPTH**  
H.360 L.1500 P.310 - H.360 W.1500 D.310

**CODICE ARTICOLO E7741151**  
**ITEM NUMBER**

FINITURA FINISH	A/V*	OPZIONE COLORE COLOUR OPTION
■ Nero Black	A	AL11
■ Titanio Titanium	A	AL12
■ Selce Flint Grey	V	AL13
■ Silver Dark Dark Silver	V	AL14
■ Oro Rosa Pink Gold	V	AL17
■ Rame Copper	V	AL23
■ Ottone Brass	V	AL24
■ Umber Umber	V	AL26

**ALTEZZA, LARGHEZZA E PROFONDITA'**  
**HEIGHT, WIDTH AND DEPTH**  
H.360 L.1500 P.310 - H.360 W.1500 D.310

**CODICE ARTICOLO E7741152**  
**ITEM NUMBER**

FINITURA FINISH	A/V*	OPZIONE COLORE COLOUR OPTION
■ Nero Black	A	AL11
■ Titanio Titanium	A	AL12
■ Selce Flint Grey	V	AL13
■ Silver Dark Dark Silver	V	AL14
■ Oro Rosa Pink Gold	V	AL17
■ Rame Copper	V	AL23
■ Ottone Brass	V	AL24
■ Umber Umber	V	AL26

**FINITURE PER RIPIANI VETRO**  
**FINISHES FOR GLASS SHELVES**

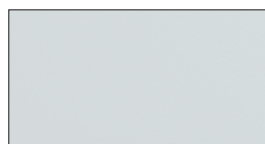

**VETRO TRASPARENTE**  
**TRANSPARENT GLASS**



**VETRO FUME' TRASPARENTE**  
**TRANSPARENT SMOKED GLASS**



**VETRO BRONZO TRASPARENTE**  
**TRANSPARENT BRONZE GLASS**

---

Pensili con schienale personalizzato  
fondo alluminio e ripiano vetro  
Wall units with personalized back panel,  
aluminum bottom and glass shelf

---

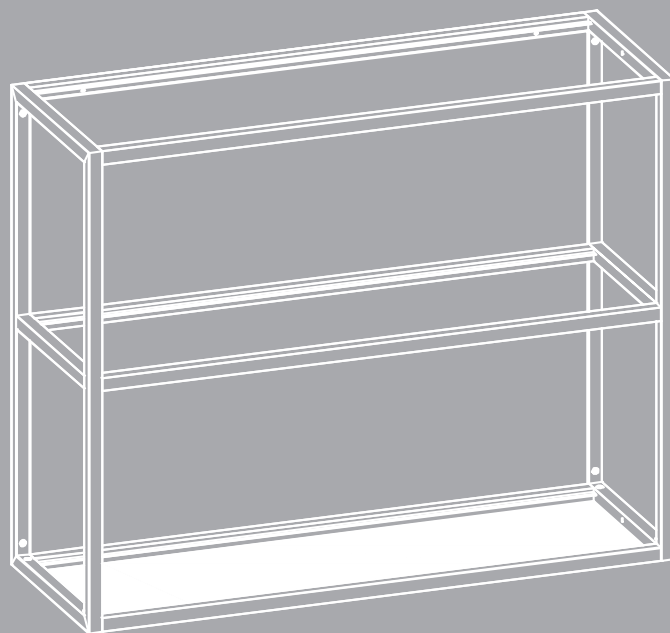

# Pensili H 240

Wall Units

\*A/V: A=ANODIZZATO V=VERNICIATO  
ANODIZED PAINTED

**N.B.: PER I COLORI DELLE SCHIENE VEDI PAG:74-77**  
**NOTE: FOR THE BACK PANEL COLORS SEE PAGE 74-77**

## ALTEZZA, LARGHEZZA E PROFONDITA'

HEIGHT, WIDTH AND DEPTH

H.240 L.600 P.310 - H.240 W.600 D.310

**CODICE ARTICOLO E7730060**

ITEM NUMBER

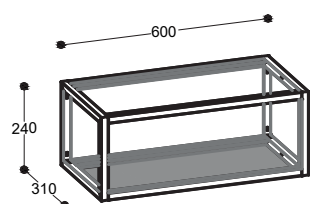

FINITURA FINISH	A/V*	OPZIONE COLORE COLOUR OPTION
<b>Nero</b> Black	A	AL11
<b>Titanio</b> Titanium	A	AL12
<b>Selce</b> Flint Grey	V	AL13
<b>Silver Dark</b> Dark Silver	V	AL14
<b>Oro Rosa</b> Pink Gold	V	AL17
<b>Rame</b> Copper	V	AL23
<b>Ottone</b> Brass	V	AL24
<b>Umber</b> Umber	V	AL26

## ALTEZZA, LARGHEZZA E PROFONDITA'

HEIGHT, WIDTH AND DEPTH

H.240 L.900 P.310 - H.240 W.900 D.310

**CODICE ARTICOLO E7730090**

ITEM NUMBER

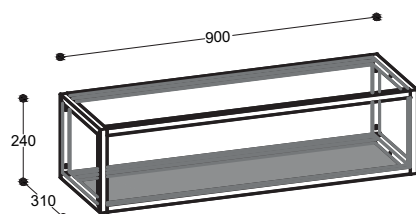

FINITURA FINISH	A/V*	OPZIONE COLORE COLOUR OPTION
<b>Nero</b> Black	A	AL11
<b>Titanio</b> Titanium	A	AL12
<b>Selce</b> Flint Grey	V	AL13
<b>Silver Dark</b> Dark Silver	V	AL14
<b>Oro Rosa</b> Pink Gold	V	AL17
<b>Rame</b> Copper	V	AL23
<b>Ottone</b> Brass	V	AL24
<b>Umber</b> Umber	V	AL26

## ALTEZZA, LARGHEZZA E PROFONDITA'

HEIGHT, WIDTH AND DEPTH

H.240 L.1200 P.310 - H.240 W.1200 D.310

**CODICE ARTICOLO E7730120**

ITEM NUMBER

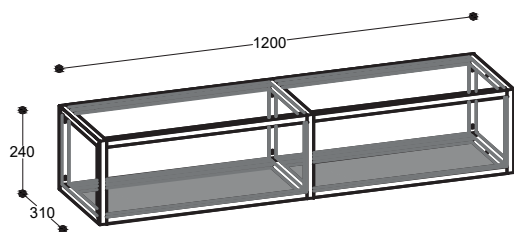

FINITURA FINISH	A/V*	OPZIONE COLORE COLOUR OPTION
<b>Nero</b> Black	A	AL11
<b>Titanio</b> Titanium	A	AL12
<b>Selce</b> Flint Grey	V	AL13
<b>Silver Dark</b> Dark Silver	V	AL14
<b>Oro Rosa</b> Pink Gold	V	AL17
<b>Rame</b> Copper	V	AL23
<b>Ottone</b> Brass	V	AL24
<b>Umber</b> Umber	V	AL26

# Pensili H 240

Wall Units

\*A/V: A=ANODIZZATO V=VERNICIATO  
ANODIZED PAINTED

**N.B.: PER I COLORI DELLE SCHIENE VEDI PAG:74-77**  
**NOTE: FOR THE BACK PANEL COLORS SEE PAGE 74-77**

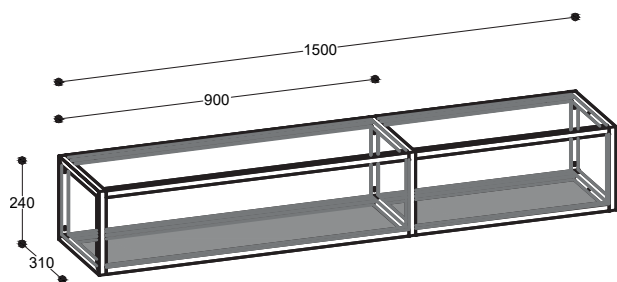

**VERSO DX**  
**TO THE RIGHT**

## ALTEZZA, LARGHEZZA E PROFONDITA'

HEIGHT, WIDTH AND DEPTH

H.240 L.1500 P.310 - H.240 W.1500 D.310

**CODICE ARTICOLO E7730151**

ITEM NUMBER

FINITURA FINISH	A/V*	OPZIONE COLORE COLOUR OPTION
<b>Nero</b> Black	A	AL11
<b>Titanio</b> Titanium	A	AL12
<b>Selce</b> Flint Grey	V	AL13
<b>Silver Dark</b> Dark Silver	V	AL14
<b>Oro Rosa</b> Pink Gold	V	AL17
<b>Rame</b> Copper	V	AL23
<b>Ottone</b> Brass	V	AL24
<b>Umber</b> Umber	V	AL26

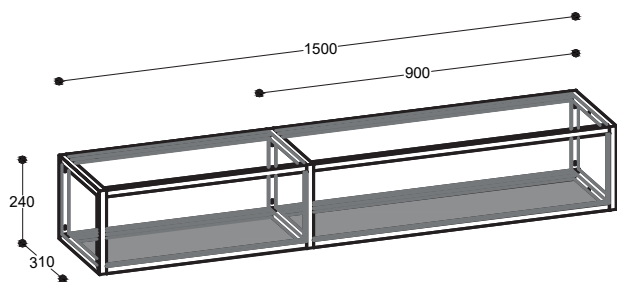

**VERSO SX**  
**TO THE LEFT**

## ALTEZZA, LARGHEZZA E PROFONDITA'

HEIGHT, WIDTH AND DEPTH

H.240 L.1500 P.310 - H.240 W.1500 D.310

**CODICE ARTICOLO E7730152**

ITEM NUMBER

FINITURA FINISH	A/V*	OPZIONE COLORE COLOUR OPTION
<b>Nero</b> Black	A	AL11
<b>Titanio</b> Titanium	A	AL12
<b>Selce</b> Flint Grey	V	AL13
<b>Silver Dark</b> Dark Silver	V	AL14
<b>Oro Rosa</b> Pink Gold	V	AL17
<b>Rame</b> Copper	V	AL23
<b>Ottone</b> Brass	V	AL24
<b>Umber</b> Umber	V	AL26

## FINITURE PER RIPIANI VETRO

FINISHES FOR GLASS SHELVES

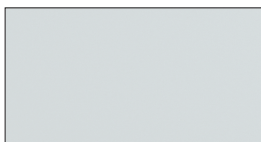

**VETRO TRASPARENTE**  
TRANSPARENT GLASS



**VETRO FUME' TRASPARENTE**  
TRANSPARENT SMOKED GLASS



**VETRO BRONZO TRASPARENTE**  
TRANSPARENT BRONZE GLASS

Pensili H 360  
Wall Units

\*A/V: A=ANODIZZATO V=VERNICIATO  
ANODIZED PAINTED

**N.B.: PER I COLORI DELLE SCHIENE VEDI PAG:74-77**  
**NOTE: FOR THE BACK PANEL COLORS SEE PAGE 74-77**

**ALTEZZA, LARGHEZZA E PROFONDITA'**  
**HEIGHT, WIDTH AND DEPTH**  
H.360 L.600 P.310 - H.360 W.600 D.310

**CODICE ARTICOLO E7731060**  
**ITEM NUMBER**

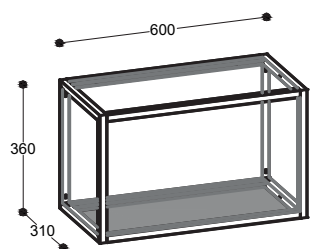

FINITURA FINISH	A/V*	OPZIONE COLORE COLOUR OPTION
<b>Nero</b> Black	A	AL11
<b>Titanio</b> Titanium	A	AL12
<b>Selce</b> Flint Grey	V	AL13
<b>Silver Dark</b> Dark Silver	V	AL14
<b>Oro Rosa</b> Pink Gold	V	AL17
<b>Rame</b> Copper	V	AL23
<b>Ottone</b> Brass	V	AL24
<b>Umber</b> Umber	V	AL26

**ALTEZZA, LARGHEZZA E PROFONDITA'**  
**HEIGHT, WIDTH AND DEPTH**  
H.360 L.900 P.310 - H.360 W.900 D.310

**CODICE ARTICOLO E7731090**  
**ITEM NUMBER**

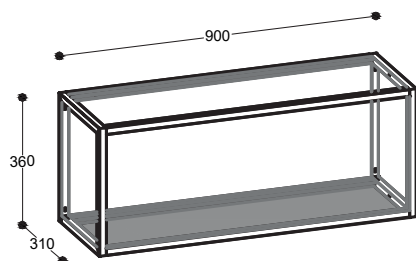

FINITURA FINISH	A/V*	OPZIONE COLORE COLOUR OPTION
<b>Nero</b> Black	A	AL11
<b>Titanio</b> Titanium	A	AL12
<b>Selce</b> Flint Grey	V	AL13
<b>Silver Dark</b> Dark Silver	V	AL14
<b>Oro Rosa</b> Pink Gold	V	AL17
<b>Rame</b> Copper	V	AL23
<b>Ottone</b> Brass	V	AL24
<b>Umber</b> Umber	V	AL26

**ALTEZZA, LARGHEZZA E PROFONDITA'**  
**HEIGHT, WIDTH AND DEPTH**  
H.360 L.1200 P.310 - H.360 W.1200 D.310

**CODICE ARTICOLO E7731120**  
**ITEM NUMBER**

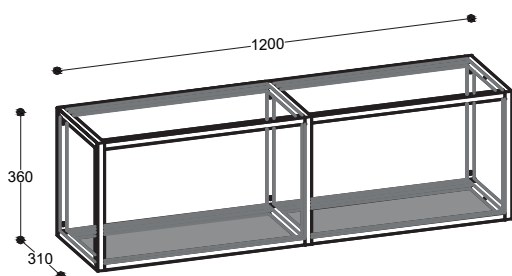

FINITURA FINISH	A/V*	OPZIONE COLORE COLOUR OPTION
<b>Nero</b> Black	A	AL11
<b>Titanio</b> Titanium	A	AL12
<b>Selce</b> Flint Grey	V	AL13
<b>Silver Dark</b> Dark Silver	V	AL14
<b>Oro Rosa</b> Pink Gold	V	AL17
<b>Rame</b> Copper	V	AL23
<b>Ottone</b> Brass	V	AL24
<b>Umber</b> Umber	V	AL26



Pensili H 360  
Wall Units

\*A/V: A=ANODIZZATO V=VERNICIATO  
ANODIZED PAINTED

**N.B.: PER I COLORI DELLE SCHIENE VEDI PAG:74-77**  
**NOTE: FOR THE BACK PANEL COLORS SEE PAGE 74-77**

**ALTEZZA, LARGHEZZA E PROFONDITA'**

**HEIGHT, WIDTH AND DEPTH**

H.360 L.1500 P.310 - H.360 W.1500 D.310

**CODICE ARTICOLO E7731151**  
**ITEM NUMBER**

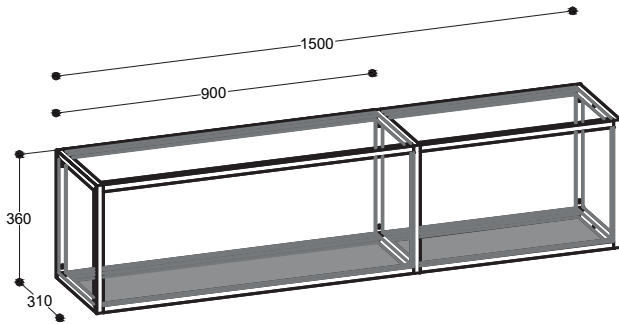

**VERSO DX**  
**TO THE RIGHT**

**FINITURA FINISH** | **A/V\*** | **OPZIONE COLORE COLOUR OPTION**

<b>Nero</b> Black	A	AL11
<b>Titanio</b> Titanium	A	AL12
<b>Selce</b> Flint Grey	V	AL13
<b>Silver Dark</b> Dark Silver	V	AL14
<b>Oro Rosa</b> Pink Gold	V	AL17
<b>Rame</b> Copper	V	AL23
<b>Ottone</b> Brass	V	AL24
<b>Umber</b> Umber	V	AL26

**ALTEZZA, LARGHEZZA E PROFONDITA'**

**HEIGHT, WIDTH AND DEPTH**

H.360 L.1500 P.310 - H.360 W.1500 D.310

**CODICE ARTICOLO E7731152**  
**ITEM NUMBER**

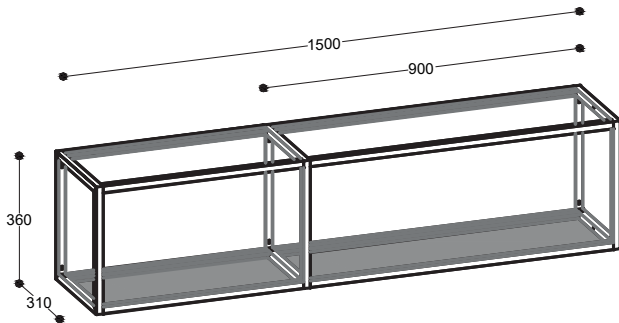

**VERSO SX**  
**TO THE LEFT**

**FINITURA FINISH** | **A/V\*** | **OPZIONE COLORE COLOUR OPTION**

<b>Nero</b> Black	A	AL11
<b>Titanio</b> Titanium	A	AL12
<b>Selce</b> Flint Grey	V	AL13
<b>Silver Dark</b> Dark Silver	V	AL14
<b>Oro Rosa</b> Pink Gold	V	AL17
<b>Rame</b> Copper	V	AL23
<b>Ottone</b> Brass	V	AL24
<b>Umber</b> Umber	V	AL26

**FINITURE PER RIPIANI VETRO**  
**FINISHES FOR GLASS SHELVES**

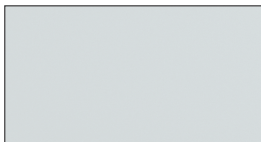

**VETRO TRASPARENTE**  
**TRANSPARENT GLASS**



**VETRO FUME' TRASPARENTE**  
**TRANSPARENT SMOKED GLASS**



**VETRO BRONZO TRASPARENTE**  
**TRANSPARENT BRONZE GLASS**

---

# Elementi terminali a giorno con schiena alluminio e ripiano vetro

Open end units with aluminum back panel and glass shelf

---

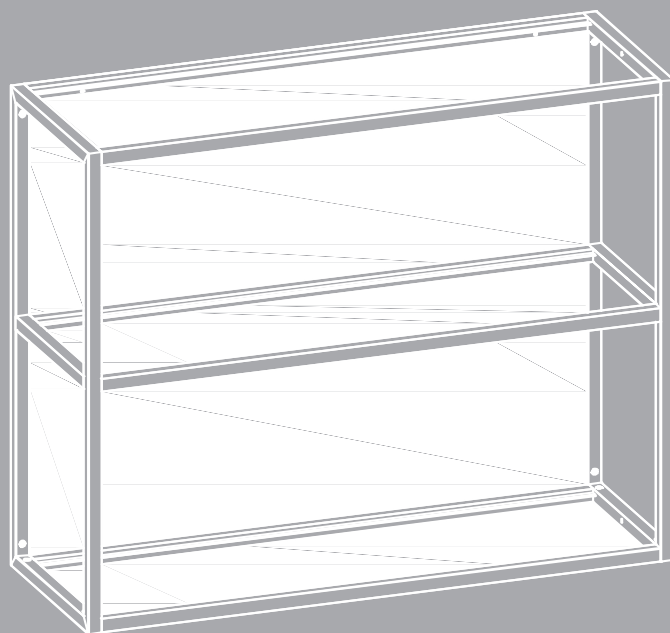

Terminali H 720  
End Units

\*A/V: A=ANODIZZATO V=VERNICIATO  
ANODIZED PAINTED

CON SCHIENALE E FONDO  
WITH BACK PANEL AND BOTTOM

**ALTEZZA, LARGHEZZA E PROFONDITA'**  
**HEIGHT, WIDTH AND DEPTH**  
H.720 L.575 P.310 - H.720 W.575 D.310

**CODICE ARTICOLO** E7812575  
**ITEM NUMBER**

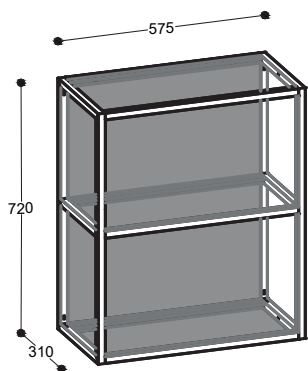

FINITURA FINISH	A/V*	OPZIONE COLORE COLOUR OPTION
■ <b>Nero</b> Black	A	AL11
■ <b>Titanio</b> Titanium	A	AL12
■ <b>Selce</b> Flint Grey	V	AL13
■ <b>Silver Dark</b> Dark Silver	V	AL14
■ <b>Oro Rosa</b> Pink Gold	V	AL17
■ <b>Rame</b> Copper	V	AL23
■ <b>Ottone</b> Brass	V	AL24
■ <b>Umber</b> Umber	V	AL26

**ALTEZZA, LARGHEZZA E PROFONDITA'**  
**HEIGHT, WIDTH AND DEPTH**  
H.720 L.885 P.310 - H.720 W.885 D.310

**CODICE ARTICOLO** E7812885  
**ITEM NUMBER**

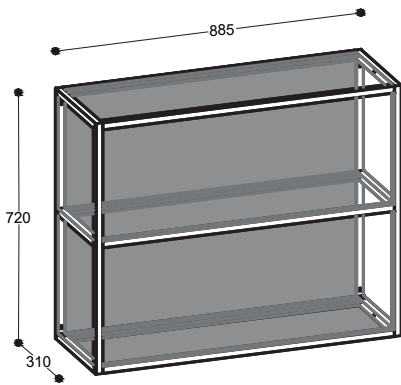

FINITURA FINISH	A/V*	OPZIONE COLORE COLOUR OPTION
■ <b>Nero</b> Black	A	AL11
■ <b>Titanio</b> Titanium	A	AL12
■ <b>Selce</b> Flint Grey	V	AL13
■ <b>Silver Dark</b> Dark Silver	V	AL14
■ <b>Oro Rosa</b> Pink Gold	V	AL17
■ <b>Rame</b> Copper	V	AL23
■ <b>Ottone</b> Brass	V	AL24
■ <b>Umber</b> Umber	V	AL26

**FINITURE PER RIPIANI VETRO**  
**FINISHES FOR GLASS SHELVES**

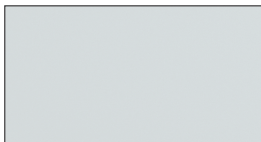

**VETRO TRASPARENTE**  
**TRANSPARENT GLASS**



**VETRO FUME' TRASPARENTE**  
**TRANSPARENT SMOKED GLASS**



**VETRO BRONZO TRASPARENTE**  
**TRANSPARENT BRONZE GLASS**

# Terminali H 750

## End Units

**\*A/V:** A=ANODIZZATO V=VERNICIATO  
ANODIZED PAINTED

CON SCHIENALE E FONDO  
WITH BACK PANEL AND BOTTOM

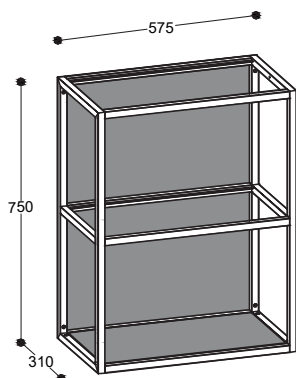

### ALTEZZA, LARGHEZZA E PROFONDITA'

HEIGHT, WIDTH AND DEPTH  
H.750 L.575 P.310 - H.750 W.575 D.310

**CODICE ARTICOLO** E7813575  
**ITEM NUMBER**

FINITURA FINISH	A/V*	OPZIONE COLORE COLOUR OPTION
■ Nero Black	A	AL11
■ Titanio Titanium	A	AL12
■ Selce Flint Grey	V	AL13
■ Silver Dark Dark Silver	V	AL14
■ Oro Rosa Pink Gold	V	AL17
■ Rame Copper	V	AL23
■ Ottone Brass	V	AL24
■ Umber Umber	V	AL26

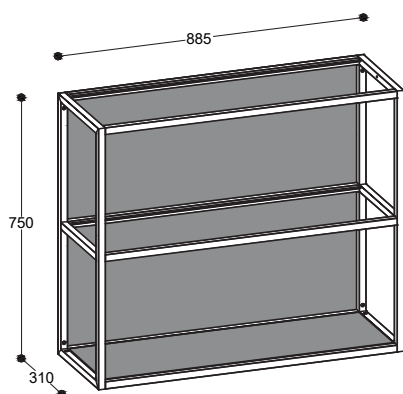

### ALTEZZA, LARGHEZZA E PROFONDITA'

HEIGHT, WIDTH AND DEPTH  
H.750 L.885 P.310 - H.750 W.885 D.310

**CODICE ARTICOLO** E7813885  
**ITEM NUMBER**

FINITURA FINISH	A/V*	OPZIONE COLORE COLOUR OPTION
■ Nero Black	A	AL11
■ Titanio Titanium	A	AL12
■ Selce Flint Grey	V	AL13
■ Silver Dark Dark Silver	V	AL14
■ Oro Rosa Pink Gold	V	AL17
■ Rame Copper	V	AL23
■ Ottone Brass	V	AL24
■ Umber Umber	V	AL26

# Terminali H 840

## End Units

\*A/V: A=ANODIZZATO V=VERNICIATO  
ANODIZED PAINTED

CON SCHIENALE E FONDO  
WITH BACK PANEL AND BOTTOM

**ALTEZZA, LARGHEZZA E PROFONDITA'**  
**HEIGHT, WIDTH AND DEPTH**  
H.840 L.885 P.310 - H.840 W.885 D.310

**CODICE ARTICOLO** E7815575  
**ITEM NUMBER**

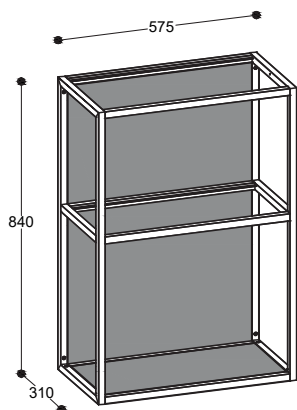

FINITURA FINISH	A/V*	OPZIONE COLORE COLOUR OPTION
■ Nero Black	A	AL11
■ Titanio Titanium	A	AL12
■ Selce Flint Grey	V	AL13
■ Silver Dark Dark Silver	V	AL14
■ Oro Rosa Pink Gold	V	AL17
■ Rame Copper	V	AL23
■ Ottone Brass	V	AL24
■ Umber Umber	V	AL26

**ALTEZZA, LARGHEZZA E PROFONDITA'**  
**HEIGHT, WIDTH AND DEPTH**  
H.840 L.885 P.310 - H.840 W.885 D.310

**CODICE ARTICOLO** E7815885  
**ITEM NUMBER**

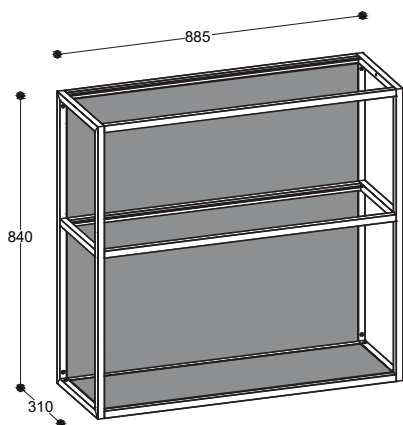

FINITURA FINISH	A/V*	OPZIONE COLORE COLOUR OPTION
■ Nero Black	A	AL11
■ Titanio Titanium	A	AL12
■ Selce Flint Grey	V	AL13
■ Silver Dark Dark Silver	V	AL14
■ Oro Rosa Pink Gold	V	AL17
■ Rame Copper	V	AL23
■ Ottone Brass	V	AL24
■ Umber Umber	V	AL26

### FINITURE PER RIPIANI VETRO

#### FINISHES FOR GLASS SHELVES

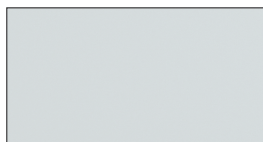

**VETRO TRASPARENTE**  
TRANSPARENT GLASS



**VETRO FUME' TRASPARENTE**  
TRANSPARENT SMOKED GLASS



**VETRO BRONZO TRASPARENTE**  
TRANSPARENT BRONZE GLASS

---

# Elementi terminali a giorno con schiena personalizzata e ripiano vetro

Open end units with personalized back panel and glass shelf

---

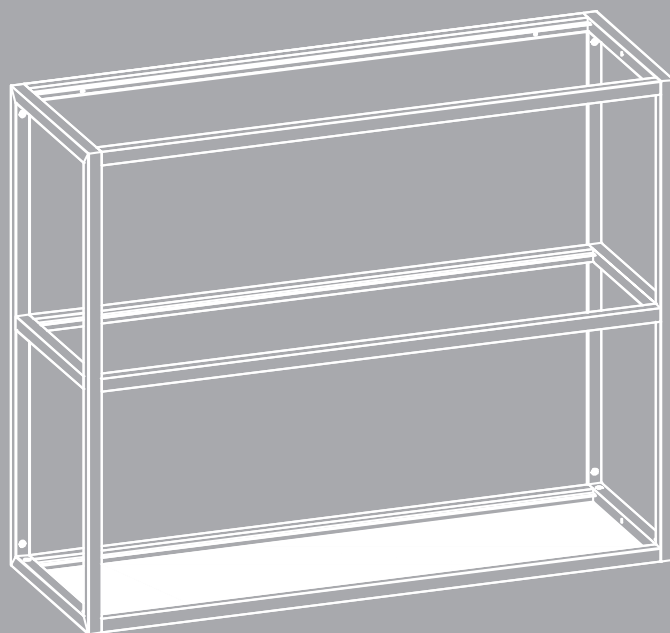

# Terminali H 720

## End Units

\*A/V: A=ANODIZZATO V=VERNICIATO  
ANODIZED PAINTED

**N.B.: PER I COLORI DELLE SCHIENE VEDI PAG:74-77**  
**NOTE: FOR THE BACK PANEL COLORS SEE PAGE 74-77**

### ALTEZZA, LARGHEZZA E PROFONDITA'

HEIGHT, WIDTH AND DEPTH

H.720 L.575 P.310 - H.720 W.575 D.310

**CODICE ARTICOLO E7762575**  
ITEM NUMBER

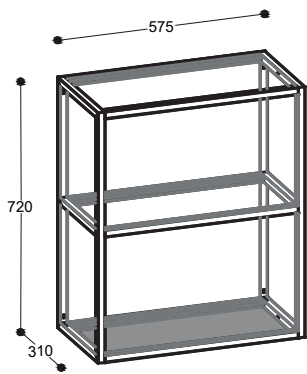

FINITURA FINISH	A/V*	OPZIONE COLORE COLOUR OPTION
■ <b>Nero</b> Black	A	AL11
■ <b>Titanio</b> Titanium	A	AL12
■ <b>Selce</b> Flint Grey	V	AL13
■ <b>Silver Dark</b> Dark Silver	V	AL14
■ <b>Oro Rosa</b> Pink Gold	V	AL17
■ <b>Rame</b> Copper	V	AL23
■ <b>Ottone</b> Brass	V	AL24
■ <b>Umber</b> Umber	V	AL26



# Terminali H 720

## End Units

\*A/V: A=ANODIZZATO V=VERNICIATO  
ANODIZED PAINTED

**N.B.: PER I COLORI DELLE SCHIENE VEDI PAG:74-77**  
**NOTE: FOR THE BACK PANEL COLORS SEE PAGE 74-77**

### ALTEZZA, LARGHEZZA E PROFONDITA'

#### HEIGHT, WIDTH AND DEPTH

H.720 L.885 P.310 - H.720 W.885 D.310

#### CODICE ARTICOLO E7762885

#### ITEM NUMBER

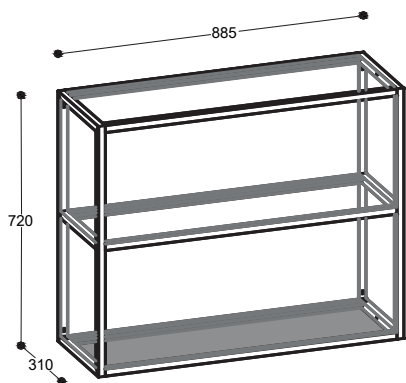

FINITURA FINISH	A/V*	OPZIONE COLORE COLOUR OPTION
<b>Nero</b> Black	A	AL11
<b>Titanio</b> Titanium	A	AL12
<b>Selce</b> Flint Grey	V	AL13
<b>Silver Dark</b> Dark Silver	V	AL14
<b>Oro Rosa</b> Pink Gold	V	AL17
<b>Rame</b> Copper	V	AL23
<b>Ottone</b> Brass	V	AL24
<b>Umber</b> Umber	V	AL26

### FINITURE PER RIPIANI VETRO

#### FINISHES FOR GLASS SHELVES

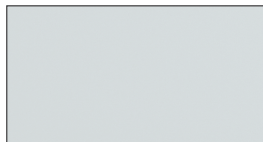

**VETRO TRASPARENTE**  
TRANSPARENT GLASS



**VETRO FUME' TRASPARENTE**  
TRANSPARENT SMOKED GLASS



**VETRO BRONZO TRASPARENTE**  
TRANSPARENT BRONZE GLASS

# Terminali H 750

## End Units

\*A/V: A=ANODIZZATO V=VERNICIATO  
ANODIZED PAINTED

**N.B.: PER I COLORI DELLE SCHIENE VEDI PAG:74-77**  
**NOTE: FOR THE BACK PANEL COLORS SEE PAGE 74-77**

### ALTEZZA, LARGHEZZA E PROFONDITA'

#### HEIGHT, WIDTH AND DEPTH

H.750 L.575 P.310 - H.750 W.575 D.310

#### CODICE ARTICOLO E7763575

#### ITEM NUMBER

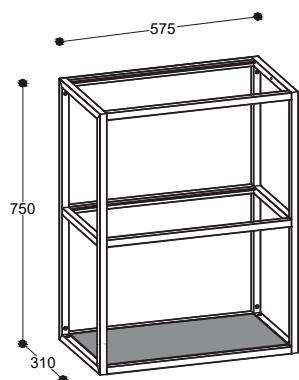

FINITURA FINISH	A/V*	OPZIONE COLORE COLOUR OPTION
■ Nero Black	A	AL11
■ Titanio Titanium	A	AL12
■ Selce Flint Grey	V	AL13
■ Silver Dark Dark Silver	V	AL14
■ Oro Rosa Pink Gold	V	AL17
■ Rame Copper	V	AL23
■ Ottone Brass	V	AL24
■ Umber Umber	V	AL26

### ALTEZZA, LARGHEZZA E PROFONDITA'

#### HEIGHT, WIDTH AND DEPTH

H.750 L.885 P.310 - H.750 W.885 D.310

#### CODICE ARTICOLO E7763885

#### ITEM NUMBER

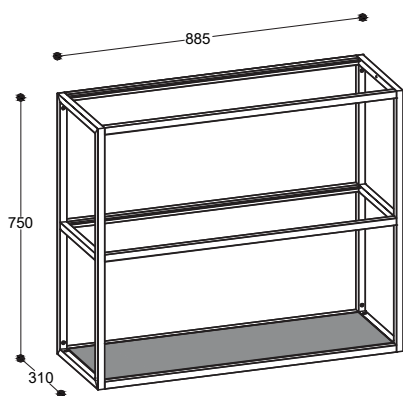

FINITURA FINISH	A/V*	OPZIONE COLORE COLOUR OPTION
■ Nero Black	A	AL11
■ Titanio Titanium	A	AL12
■ Selce Flint Grey	V	AL13
■ Silver Dark Dark Silver	V	AL14
■ Oro Rosa Pink Gold	V	AL17
■ Rame Copper	V	AL23
■ Ottone Brass	V	AL24
■ Umber Umber	V	AL26

# Terminali H 840

## End Units

\*A/V: A=ANODIZZATO V=VERNICIATO  
ANODIZED PAINTED

**N.B.: PER I COLORI DELLE SCHIENE VEDI PAG:74-77**  
**NOTE: FOR THE BACK PANEL COLORS SEE PAGE 74-77**

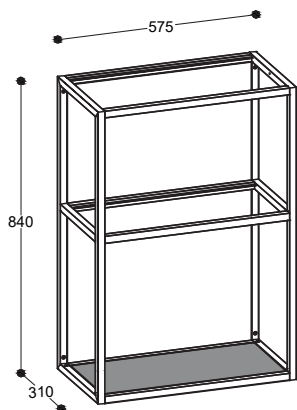

### ALTEZZA, LARGHEZZA E PROFONDITA'

HEIGHT, WIDTH AND DEPTH  
H.840 L.575 P.310 - H.840 W.575 D.310

**CODICE ARTICOLO E7765575**  
ITEM NUMBER

FINITURA FINISH	A/V*	OPZIONE COLORE COLOUR OPTION
■ Nero Black	A	AL11
■ Titanio Titanium	A	AL12
■ Selce Flint Grey	V	AL13
■ Silver Dark Dark Silver	V	AL14
■ Oro Rosa Pink Gold	V	AL17
■ Rame Copper	V	AL23
■ Ottone Brass	V	AL24
■ Umber Umber	V	AL26

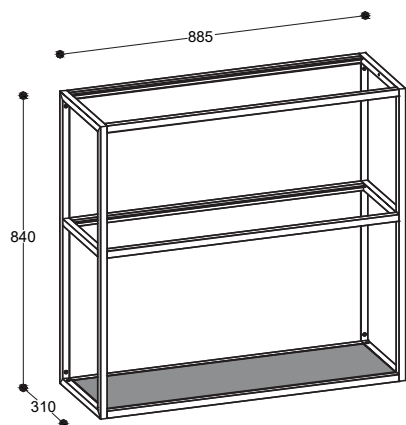

### ALTEZZA, LARGHEZZA E PROFONDITA'

HEIGHT, WIDTH AND DEPTH  
H.840 L.885 P.31 - H.840 W.885 D.310

**CODICE ARTICOLO E7765885**  
ITEM NUMBER

FINITURA FINISH	A/V*	OPZIONE COLORE COLOUR OPTION
■ Nero Black	A	AL11
■ Titanio Titanium	A	AL12
■ Selce Flint Grey	V	AL13
■ Silver Dark Dark Silver	V	AL14
■ Oro Rosa Pink Gold	V	AL17
■ Rame Copper	V	AL23
■ Ottone Brass	V	AL24
■ Umber Umber	V	AL26

**Nero AL11**  
Anodizzato



**Selce AL13**  
Verniciato

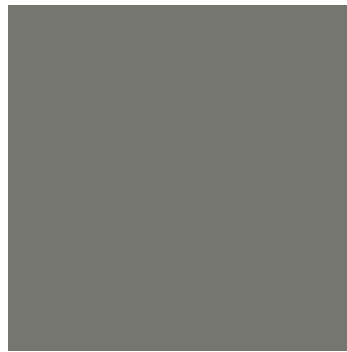

**Titanio AL12**  
Anodizzato



**Silver Dark AL14**  
Verniciato



**Oro Rosa AL17**  
Verniciato

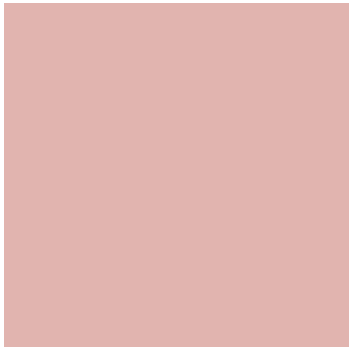

**Ottone AL24**  
Verniciato



**Rame AL23**  
Verniciato



**Umber AL26**  
Verniciato



**COLORI IMPIALLACCIATI MODELLO OLTRE FASCIA C**  
**OLTRE MODEL VENEERED COLOURS BAND C**



**COLORI IMPIALLACCIATI MODELLO CLOVER FASCIA C**  
**CLOVER MODEL VENEERED COLOURS BAND C**



**COLORI IMPIALLACCIATI MODELLO LUNA FASCIA C**  
**LUNA MODEL VENEERED COLOURS BAND C**



**COLORI IMPIALLACCIATI MODELLO IMMAGINA WOOD FASCIA B**  
**IMMAGINA WOOD MODEL VENEERED COLOURS BAND B**



**COLORI IMPIALLACCIATI MODELLO FLAVOUR FASCIA C**  
**FLAVOUR MODEL VENEERED COLOURS BAND C**

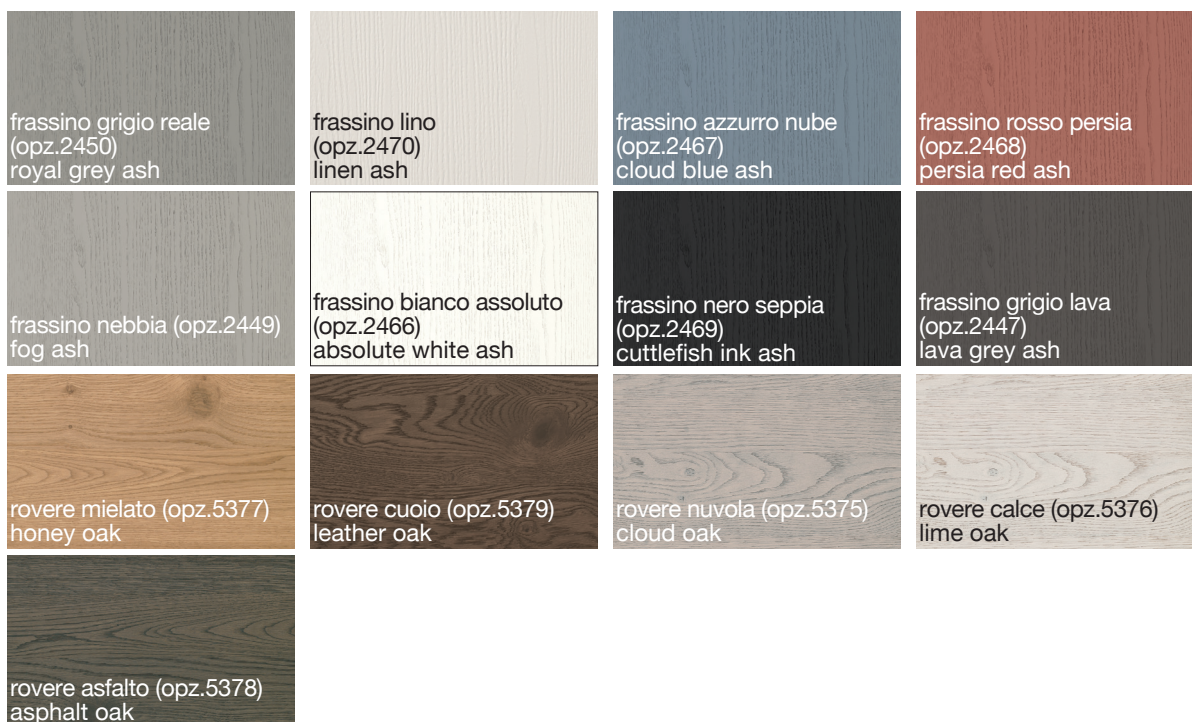

**COLORI FRASSINO MODELLO VERONICA FASCIA C**  
**VERONICA MODEL ASH COLOURS BAND C**



**COLORI FRASSINO MODELLO CONTEMPO FASCIA C**  
**CONTEMPOMODEL ASH COLOURS BAND C**



**COLORI EFFETTO MARMO FASCIA A**  
**COLOURS MARBLE EFFECT BAND A**

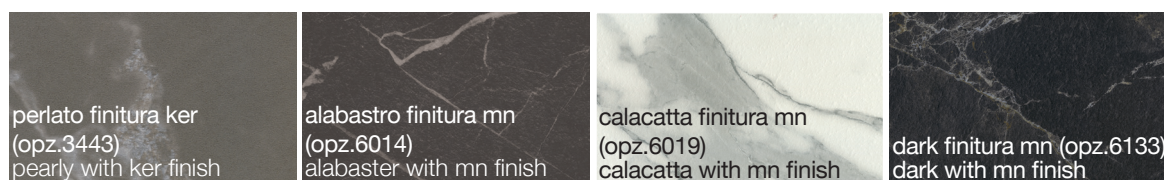



**COLORI LACCATI UV FASCIA A**  
**UV LACQUERED COLOURS BAND A**

 bianco (opz.7405) white	 antracite (opz.9558) anthracite	 grigio arena (opz.9521) arena grey	 rosso vino (opz.8163) wine red
 bianco neve (opz.7407) snow white	 verde malga (opz.8477) alpine green	 ardesia (opz.9525) slate grey	 nero (opz.7895) black
 desert (opz.8941) desert	 polvere (opz.9529) dust	 cannella (opz.8891) cinnamon	 blu cobalto (opz.8383) cobalt blue





# Modularità e Componibilità per zoccolo H 6

MODULARITY AND FITTING SOLUTIONS FOR PLINTH H 6

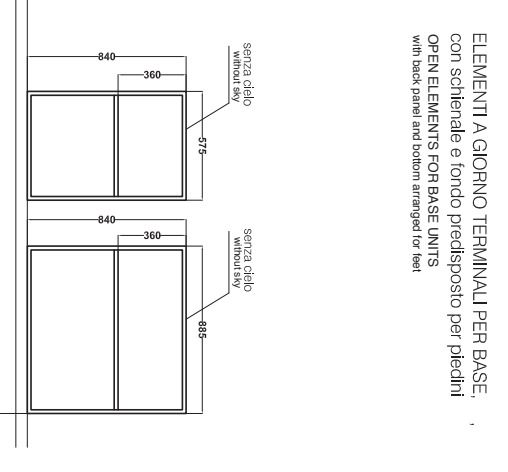
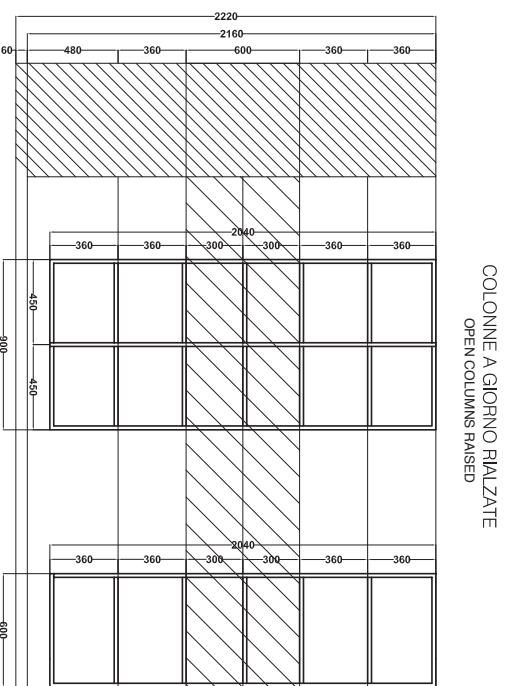
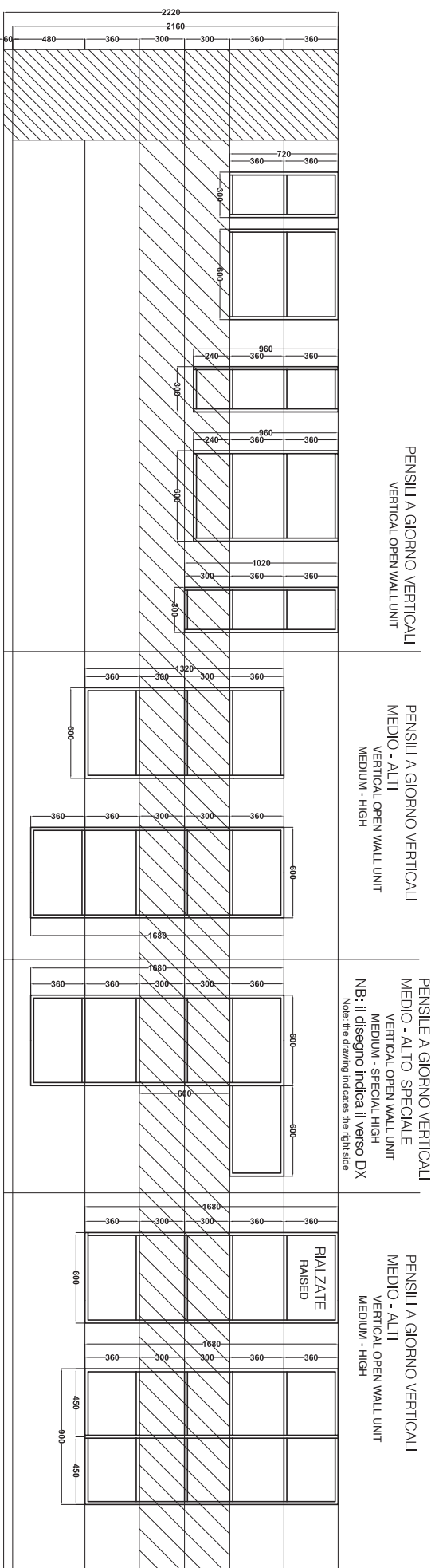

tondo predisposto per montaggio dei piedini regolabili bottom prepared for mounting adjustable feet

Lato anteriore front side

CUCINE  
**LUBE**

GRUPPO LUBE

**CREO**  
KITCHENS

# Boiserie Cover





# BOISERIE COVER IN APPOGGIO

COVER BOISERIE ON SUPPORT

**Modulo cm 45-60-65-90 P 1,8  
per pensile H 72**

**N.B.: disponibilità kit  
ferramenta per bloccaggio  
pannello telescopico  
vedi pag.30**

Rack element  
cm 45-60-65-90 D 1,8  
for wall unit H 72

Note: availability of hardware  
kit for locking telescopic  
panel see page 30

**CODICE  
CODE No.**

**DESERT**

**STONE  
GREY**

**SILVER  
DARK**

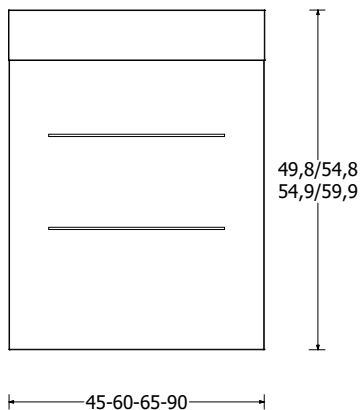

**FIANCO H 72/H 84**

L 45 da 54,9 a 59,9  
L 60 da 54,9 a 59,9  
L 65 da 54,9 a 59,9  
L 90 da 54,9 a 59,9

**SIDE H 72/H 84**

W 45 from 54.9 to 59.9  
W 60 from 54.9 to 59.9  
W 65 from 54.9 to 59.9  
W 90 from 54.9 to 59.9

**086SH45055  
086SH60055  
086SH65055  
086SH90055**

**FIANCO H 75**

**per altezza top maggiore e uguale a 24 mm**

L 45 da 49,8 a 54,8  
L 60 da 49,8 a 54,8  
L 65 da 49,8 a 54,8  
L 90 da 49,8 a 54,8

**SIDE H 75**

**for greater top height and equal to 24 mm**

W 45 from 49,8 to 54,8  
W 60 from 49,8 to 54,8  
W 65 from 49,8 to 54,8  
W 90 from 49,8 to 54,8

**086SH45045  
086SH60045  
086SH65045  
086SH90045**

**per altezza top minore a 24 mm**

L 45 da 54,9 a 59,9  
L 60 da 54,9 a 59,9  
L 65 da 54,9 a 59,9  
L 90 da 54,9 a 59,9

**for lesser top height to 24 mm**

W 45 from 54.9 to 59.9  
W 60 from 54.9 to 59.9  
W 65 from 54.9 to 59.9  
W 90 from 54.9 to 59.9

**086SH45055  
086SH60055  
086SH65055  
086SH90055**

## Finiture "BOISERIE"

"BOISERIE" finishes

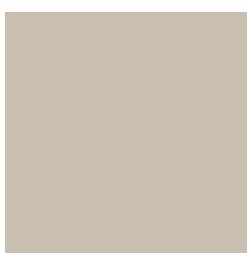

**Desert (opz.D)**

Desert

**N.B.: riferimento immagine  
(opz.8941) UV**

Note: reference immagine  
(opt.8941) UV



**Stone Grey (opz.G)**

Grey Stone

**N.B.: riferimento immagine  
melaminico (opz.9650)**

Note: reference immagine  
melamine (opt.9650)



**Silver Dark (opz.S)**

Dark Silver

# BOISERIE COVER IN APPOGGIO

COVER BOISERIE ON SUPPORT

**Modulo cm 45-60-65-90 P 1,8  
per pensile H 60**

**N.B.: disponibilità kit  
ferramenta per bloccaggio  
pannello telescopico  
vedi pag.30**

Rack element  
cm 45-60-65-90 D 1,8  
for wall unit H 60

Note: availability of hardware  
kit for locking telescopic  
panel see page 30

**CODICE  
CODE No.**

**DESERT**

**STONE  
GREY**

**SILVER  
DARK**

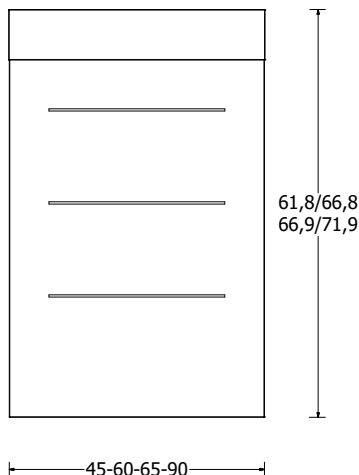

**FIANCO H 72/H 84**

L 45 da 66,9 a 71,9  
L 60 da 66,9 a 71,9  
L 65 da 66,9 a 71,9  
L 90 da 66,9 a 71,9

**SIDE H 72/H 84**

W 45 from 66.9 to 71.9  
W 60 from 66.9 to 71.9  
W 65 from 66.9 to 71.9  
W 90 from 66.9 to 71.9

**086SH45067**  
**086SH60067**  
**086SH65067**  
**086SH90067**

**FIANCO H 75**

**per altezza top maggiore e uguale a 24 mm**

L 45 da 61,8 a 66,8  
L 60 da 61,8 a 66,8  
L 65 da 61,8 a 66,8  
L 90 da 61,8 a 66,8

**SIDE H 75**

**for greater top height and equal to 24 mm**

W 45 from 61,8 to 66,8  
W 60 from 61,8 to 66,8  
W 65 from 61,8 to 66,8  
W 90 from 61,8 to 66,8

**086SH45066**  
**086SH60066**  
**086SH65066**  
**086SH90066**

**per altezza top minore a 24 mm**

L 45 da 66,9 a 71,9  
L 60 da 66,9 a 71,9  
L 65 da 66,9 a 71,9  
L 90 da 66,9 a 71,9

**for lesser top height to 24 mm**

W 45 from 66.9 to 71.9  
W 60 from 66.9 to 71.9  
W 65 from 66.9 to 71.9  
W 90 from 66.9 to 71.9

**086SH45067**  
**086SH60067**  
**086SH65067**  
**086SH90067**

## Finiture "BOISERIE"

"BOISERIE" finishes



**Desert (opz.D)**

Desert

**N.B.: riferimento immagine  
(opz.8941) UV**

Note: reference immagine  
(opt.8941) UV

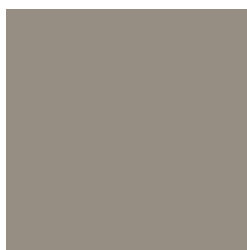

**Stone Grey (opz.G)**

Grey Stone

**N.B.: riferimento immagine  
melaminico (opz.9650)**

Note: reference immagine  
melamine (opt.9650)



**Silver Dark (opz.S)**

Dark Silver



# BOISERIE COVER IN APPOGGIO

COVER BOISERIE ON SUPPORT

**Modulo cm 45-60-65-90 P 1,8  
per pensile H 48**

**N.B.: disponibilità kit  
ferramenta per bloccaggio  
pannello telescopico  
vedi pag.30**

Rack element  
cm 45-60-65-90 D 1,8  
for wall unit H 48

Note: availability of hardware  
kit for locking telescopic  
panel see page 30

**CODICE  
CODE No.**

**DESERT**

**STONE  
GREY**

**SILVER  
DARK**

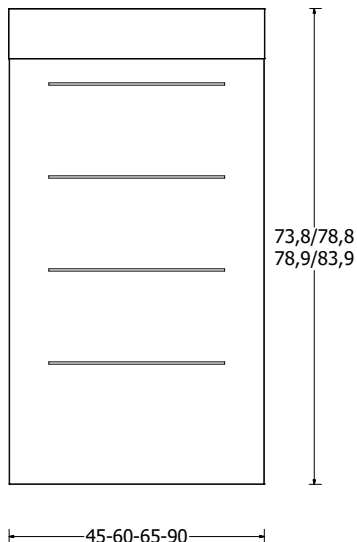

**FIANCO H 72/H 84**

L 45 da 78,9 a 83,9  
L 60 da 78,9 a 83,9  
L 65 da 78,9 a 83,9  
L 90 da 78,9 a 83,9

**SIDE H 72/H 84**

W 45 from 78.9 to 83.9  
W 60 from 78.9 to 83.9  
W 65 from 78.9 to 83.9  
W 90 from 78.9 to 83.9

**086SH45079**  
**086SH60079**  
**086SH65079**  
**086SH90079**

**FIANCO H 75**

**per altezza top maggiore e uguale a 24 mm**

L 45 da 73,8 a 78,8  
L 60 da 73,8 a 78,8  
L 65 da 73,8 a 78,8  
L 90 da 73,8 a 78,8

**SIDE H 75**

**for greater top height and equal to 24 mm**

W 45 from 73,8 to 78,8  
W 60 from 73,8 to 78,8  
W 65 from 73,8 to 78,8  
W 90 from 73,8 to 78,8

**086SH45077**  
**086SH60077**  
**086SH65077**  
**086SH90077**

**per altezza top minore a 24 mm**

L 45 da 78,9 a 83,9  
L 60 da 78,9 a 83,9  
L 65 da 78,9 a 83,9  
L 90 da 78,9 a 83,9

**for lesser top height to 24 mm**

W 45 from 78.9 to 83.9  
W 60 from 78.9 to 83.9  
W 65 from 78.9 to 83.9  
W 90 from 78.9 to 83.9

**086SH45079**  
**086SH60079**  
**086SH65079**  
**086SH90079**

## Finiture "BOISERIE"

"BOISERIE" finishes

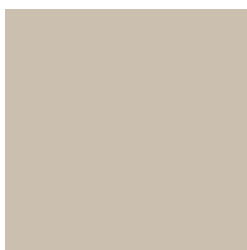

**Desert (opz.D)**

Desert

**N.B.: riferimento immagine  
(opz.8941) UV**

Note: reference immagine  
(opt.8941) UV

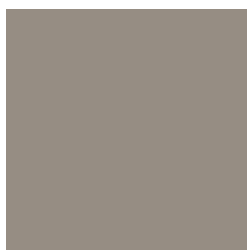

**Stone Grey (opz.G)**

Grey Stone

**N.B.: riferimento immagine  
melaminico (opz.9650)**

Note: reference immagine  
melamine (opt.9650)

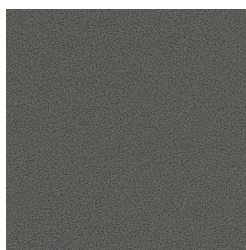

**Silver Dark (opz.S)**

Dark Silver

# BOISERIE COVER IN APPOGGIO

COVER BOISERIE ON SUPPORT

**Modulo cm 45-60-65-90 P 1,8  
per pensile H 36**

**N.B.: disponibilità kit  
ferramenta per bloccaggio  
pannello telescopico  
vedi pag.30**

Rack element  
cm 45-60-65-90 D 1,8  
for wall unit H 36

Note: availability of hardware  
kit for locking telescopic  
panel see page 30

**CODICE  
CODE No.**

**DESERT**

**STONE  
GREY**

**SILVER  
DARK**

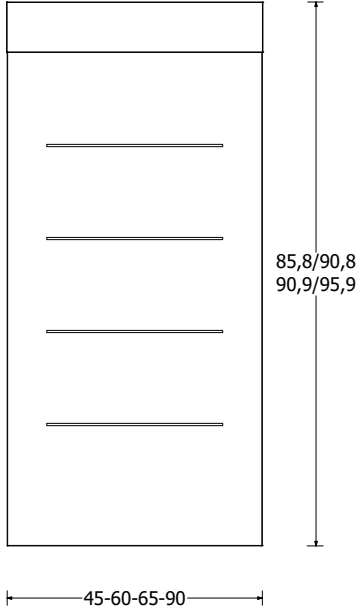

**FIANCO H 72/H 84**

L 45 da 90,9 a 95,9  
L 60 da 90,9 a 95,9  
L 65 da 90,9 a 95,9  
L 90 da 90,9 a 95,9

**SIDE H 72/H 84**

W 45 from 90.9 to 95.9  
W 60 from 90.9 to 95.9  
W 65 from 90.9 to 95.9  
W 90 from 90.9 to 95.9

**086SH45091**  
**086SH60091**  
**086SH65091**  
**086SH90091**

**FIANCO H 75**

**per altezza top maggiore e uguale a 24 mm**

L 45 da 85,8 a 90,8  
L 60 da 85,8 a 90,8  
L 65 da 85,8 a 90,8  
L 90 da 85,8 a 90,8

**SIDE H 75**

**for greater top height and equal to 24 mm**

W 45 from 85,8 to 90,8  
W 60 from 85,8 to 90,8  
W 65 from 85,8 to 90,8  
W 90 from 85,8 to 90,8

**086SH45089**  
**086SH60089**  
**086SH65089**  
**086SH90089**

**per altezza top minore a 24 mm**

L 45 da 90,9 a 95,9  
L 60 da 90,9 a 95,9  
L 65 da 90,9 a 95,9  
L 90 da 90,9 a 95,9

**for lesser top height to 24 mm**

W 45 from 90.9 to 95.9  
W 60 from 90.9 to 95.9  
W 65 from 90.9 to 95.9  
W 90 from 90.9 to 95.9

**086SH45091**  
**086SH60091**  
**086SH65091**  
**086SH90091**

## Finiture "BOISERIE"

"BOISERIE" finishes



**Desert (opz.D)**

Desert

**N.B.: riferimento immagine  
(opz.8941) UV**

Note: reference immagine  
(opt.8941) UV



**Stone Grey (opz.G)**

Grey Stone

**N.B.: riferimento immagine  
melaminico (opz.9650)**

Note: reference immagine  
melamine (opt.9650)

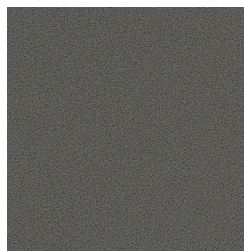

**Silver Dark (opz.S)**

Dark Silver

# BOISERIE COVER IN APPOGGIO

COVER BOISERIE ON SUPPORT

Modulo cm 45-60-65-90 P 1,8

Rack element  
cm 45-60-65-90 D 1,8

**N.B.: se utilizzato senza  
sopracolonna disponibilità  
kit ferramenta per bloccaggio  
pannello telescopico  
vedi pag.30**

Note: if used without column  
availability of hardware  
kit for locking telescopic  
panel see page 30

**CODICE  
CODE No.**

**DESERT**

**STONE  
GREY**

**SILVER  
DARK**

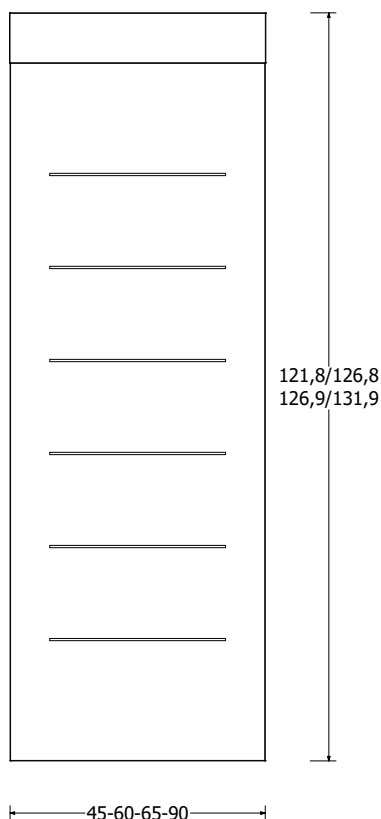

**FIANCO H 72/H 84**

L 45 da 126,9 a 131,9  
L 60 da 126,9 a 131,9  
L 65 da 126,9 a 131,9  
L 90 da 126,9 a 131,9

**SIDE H 72/H 84**

W 45 from 126.9 to 131.9  
W 60 from 126.9 to 131.9  
W 65 from 126.9 to 131.9  
W 90 from 126.9 to 131.9

**086SH45123**  
**086SH60123**  
**086SH65123**  
**086SH90123**

**FIANCO H 75**

**per altezza top maggiore e uguale a 24 mm**

L 45 da 121,8 a 126,8  
L 60 da 121,8 a 126,8  
L 65 da 121,8 a 126,8  
L 90 da 121,8 a 126,8

**SIDE H 75**

**for greater top height and equal to 24 mm**

W 45 from 121,8 to 126,8  
W 60 from 121,8 to 126,8  
W 65 from 121,8 to 126,8  
W 90 from 121,8 to 126,8

**086SH45122**  
**086SH60122**  
**086SH65122**  
**086SH90122**

**per altezza top minore a 24 mm**

L 45 da 126,9 a 131,9  
L 60 da 126,9 a 131,9  
L 65 da 126,9 a 131,9  
L 90 da 126,9 a 131,9

**for lesser top height to 24 mm**

W 45 from 126.9 to 131.9  
W 60 from 126.9 to 131.9  
W 65 from 126.9 to 131.9  
W 90 from 126.9 to 131.9

**086SH45123**  
**086SH60123**  
**086SH65123**  
**086SH90123**

## Finiture "BOISERIE"

"BOISERIE" finishes

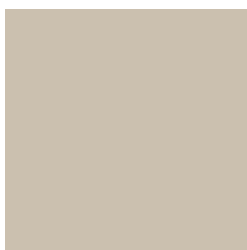

**Desert (opz.D)**

Desert

**N.B.: riferimento immagine  
(opz.8941) UV**

Note: reference immagine  
(opt.8941) UV

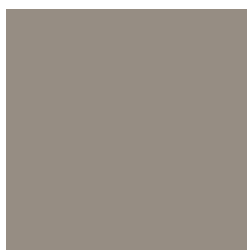

**Stone Grey (opz.G)**

Grey Stone

**N.B.: riferimento immagine  
melaminico (opz.9650)**

Note: reference immagine  
melamine (opt.9650)



**Silver Dark (opz.S)**

Dark Silver

# BOISERIE COVER SOSPESA

COVER BOISERIE HANGING

Modulo cm 60  
P 1,8 H 114

Rack element cm 60  
D 1,8 H 114

**CODICE**  
*CODE No.*

**DESERT**

**STONE  
GREY**

**SILVER  
DARK**

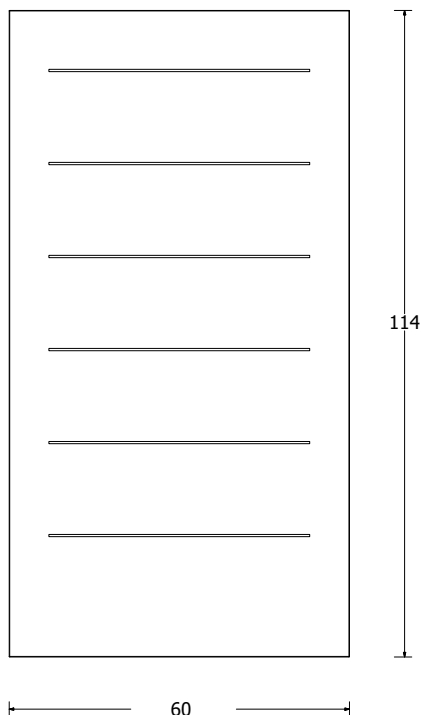

**H 114**  
L 60

H 114  
W 60

**086SHS6011**

## Finiture "BOISERIE"

"BOISERIE" finishes



**Desert (opz.D)**

Desert

**N.B.: riferimento immagine (opz.8941) UV**

Note: reference immagine (opt.8941) UV

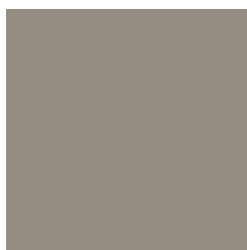

**Stone Grey (opz.G)**

Grey Stone

**N.B.: riferimento immagine melaminico (opz.9650)**

Note: reference immagine melamine (opt.9650)



**Silver Dark (opz.S)**

Dark Silver

# BOISERIE COVER SOSPESA

COVER BOISERIE HANGING

Modulo cm 60 P 1,8  
per colonna

Rack element  
cm 60 D 1,8 for column

**CODICE**  
*CODE No.*

**DESERT**

**STONE  
GREY**

**SILVER  
DARK**

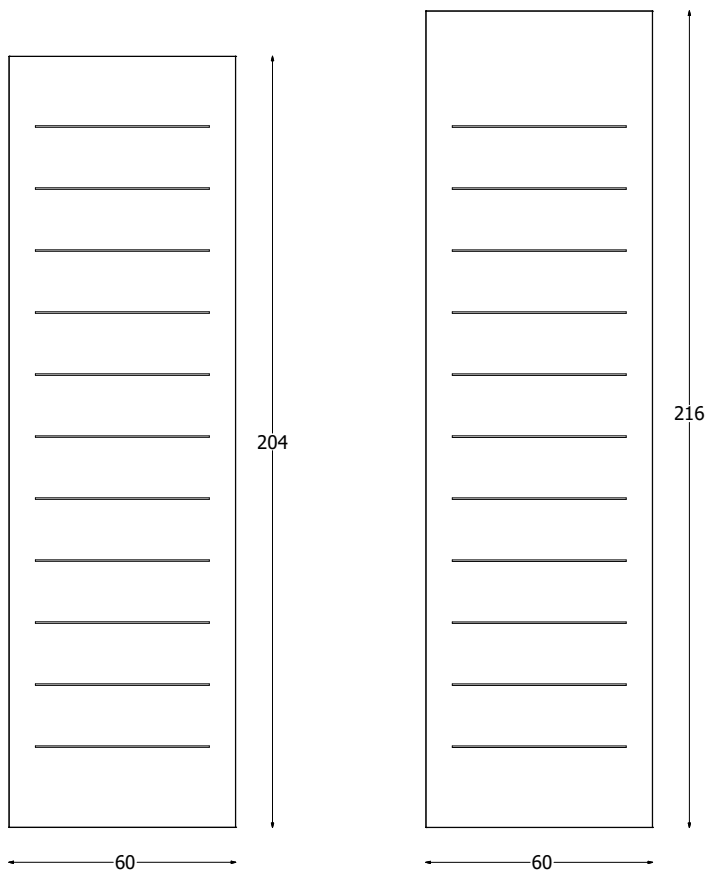

**FIANCO H 204**  
L 60

SIDE H 204  
W 60

**086SHL6020**

**FIANCO H 216**  
L 60

SIDE H 216  
W 60

**086SHL6021**

## Finiture "BOISERIE"

"BOISERIE" finishes



**Desert (opz.D)**

Desert

**N.B.: riferimento immagine  
(opz.8941) UV**

Note: reference immagine  
(opt.8941) UV

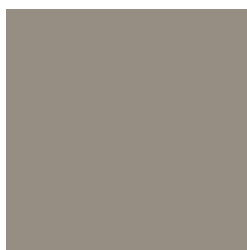

**Stone Grey (opz.G)**

Grey Stone

**N.B.: riferimento immagine  
melaminico (opz.9650)**

Note: reference immagine  
melamine (opt.9650)

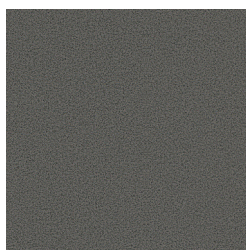

**Silver Dark (opz.S)**

Dark Silver

# TERMINALI COVER

## COVER END UNITS

**Terminale isola/penisola H 72  
zoccolo H 13**

End unit  
island/peninsula H 72  
plinth H 13

**N.B.: possibilità di inserimento  
luce sul cielo, per alimentatore  
vedi listino luci L&S**

Note: possibility  
to insert light on  
top, for the power  
supply see L&S light  
pricelist

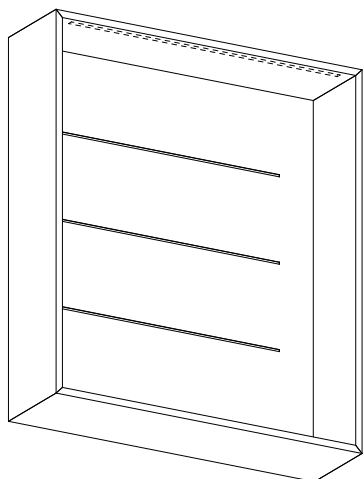

**N.B.: Schienale non rifinito, non progettare a sbalzo  
rispetto alle basi**

Unfinished back panel, do not design cantilever  
than the base unit

L 16,8 H 72 P 62,3  
Luce 7,8W

W 16,8 H 72 D 62,3  
Light 7,8W

**086SHF56**  
**08618325**

**CODICE**  
*CODE No.*

**ROUND**  
**PET**

**CLOVER**  
**IMP.**  
**FASCIA A**

**CLOVER**  
**IMP.**  
**FASCIA B**

**LUNA**  
**IMP.**  
**FASCIA A**

**LUNA**  
**IMP.**  
**FASCIA B**

**FLAVOUR**  
**IMP.**  
**FASCIA B**

**FLAVOUR**  
**IMP.**  
**FASCIA C**

**CLOVER**  
**LUNA**  
**FLAVOUR**  
**LACCATO**  
**OPACO**

## Finiture "BOISERIE"

"BOISERIE" finishes

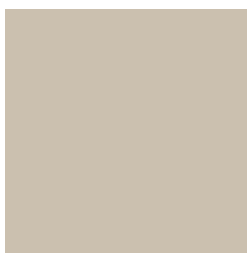

**Desert (opz.D)**

Desert

**N.B.: riferimento immagine  
(opz.8941) UV**

Note: reference immagine  
(opt.8941) UV



**Stone Grey (opz.G)**

Grey Stone

**N.B.: riferimento immagine  
melaminico (opz.9650)**

Note: reference immagine  
melamine (opt.9650)



**Silver Dark (opz.S)**

Dark Silver

# TERMINALI COVER

## COVER END UNITS

**Terminale isola/penisola H 75  
zoccolo H 13**

End unit island/peninsula H 75 plinth H 13

**N.B.: possibilità di inserimento  
luce sul cielo, per alimentatore  
vedi listino luci L&S**

Note: possibility to insert light on top,  
for the power supply see L&S light  
pricelist

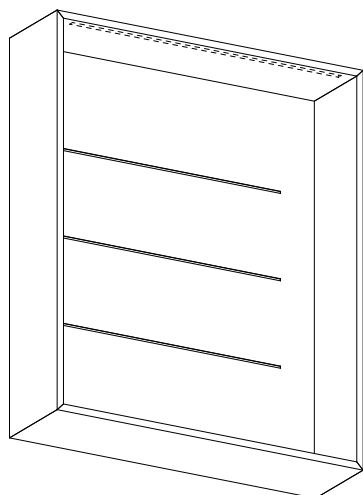

**N.B.: Schienale non rifinito, non progettare a sbalzo  
rispetto alle basi**

Unfinished back panel, do not design cantilever  
than the base unit

L 16,8 H 75 P 62,3  
Luce 7,8W

W 16,8 H 75 D 62,3  
Light 7,8W

**086SHF58**  
**08618325**

**CODICE**  
*CODE No.*

**ROUND**  
**PET**

**CLOVER**  
**IMP.**  
**FASCIA A**

**CLOVER**  
**IMP.**  
**FASCIA B**

**FLAVOUR**  
**IMP.**  
**FASCIA B**

**FLAVOUR**  
**IMP.**  
**FASCIA C**

**CLOVER**  
**FLAVOUR**  
**LACCATO**  
**OPACO**

## Finiture "BOISERIE"

"BOISERIE" finishes



**Desert (opz.D)**

Desert

**N.B.: riferimento immagine  
(opz.8941) UV**

Note: reference immagine  
(opt.8941) UV

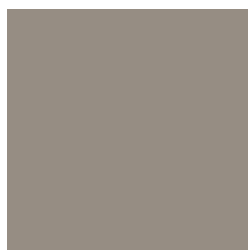

**Stone Grey (opz.G)**

Grey Stone

**N.B.: riferimento immagine  
melaminico (opz.9650)**

Note: reference immagine  
melamine (opt.9650)



**Silver Dark (opz.S)**

Dark Silver

# TERMINALI COVER

## COVER END UNITS

**Terminale isola/penisola H 84  
zoccolo H 6**

End unit island/peninsula H 84 plinth H 6

**N.B.: possibilità di inserimento  
luce sul cielo, per alimentatore  
vedi listino luci L&S**

Note: possibility to insert light on top, for the  
power supply see L&S light pricelist

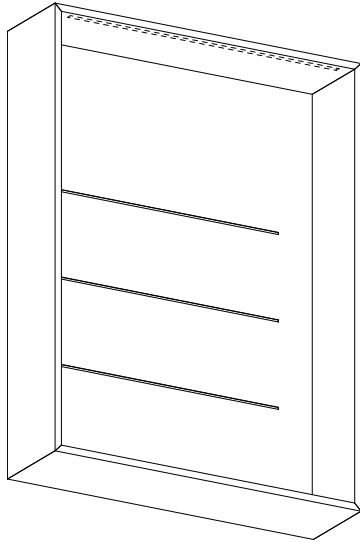

**N.B.: Schienale non rifinito, non progettare a sbalzo  
rispetto alle basi**

Unfinished back panel, do not design cantilever  
than the base unit

L 16,8 H 84 P 62,3  
Luce 7,8W

W 16,8 H 84 D 62,3  
Light 7,8W

**086SHF66**  
**08618325**

**CODICE**  
*CODE No.*

**ROUND**  
**PET**

**OLTRE**  
**IMP.**

**FLAVOUR**  
**IMP.**  
**FASCIA B**

**FLAVOUR**  
**IMP.**  
**FASCIA C**

**OLTRE**  
**FLAVOUR**  
**LACCATO**  
**OPACO**

## Finiture "BOISERIE"

"BOISERIE" finishes



**Desert (opz.D)**

Desert

**N.B.: riferimento immagine  
(opz.8941) UV**

Note: reference immagine  
(opt.8941) UV

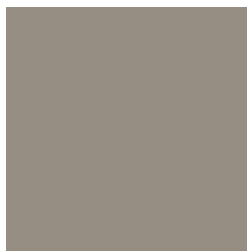

**Stone Grey (opz.G)**

Grey Stone

**N.B.: riferimento immagine  
melaminico (opz.9650)**

Note: reference immagine  
melamine (opt.9650)



**Silver Dark (opz.S)**

Dark Silver



# TERMINALI COVER

## COVER END UNITS

Terminale isola H 72  
zoccolo H 13

End unit island H 72  
plinth H 13

**N.B.: possibilità di inserimento  
luce sul cielo, per alimentatore  
vedi listino luci L&S**

Note: possibility  
to insert light on  
top, for the power  
supply see L&S light  
pricelist

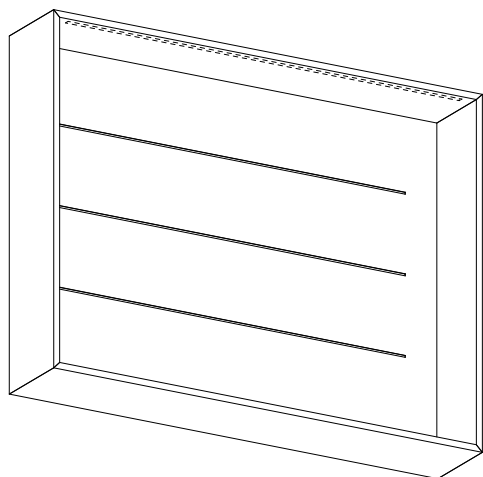

**N.B.: Schienale non rifinito, non progettare a sbalzo  
rispetto alle basi**

Unfinished back panel, do not design cantilever  
than the base unit

L 16,8 H 72 P 93,5  
Luce 11,8W

W 16,8 H 72 D 93,5  
Light 11,8W

**086SHF57**  
**08618326**

**CODICE**  
*CODE No.*

**ROUND**  
**PET**

**CLOVER**  
**IMP.**  
**FASCIA A**

**CLOVER**  
**IMP.**  
**FASCIA B**

**LUNA**  
**IMP.**  
**FASCIA A**

**LUNA**  
**IMP.**  
**FASCIA B**

**FLAVOUR**  
**IMP.**  
**FASCIA B**

**FLAVOUR**  
**IMP.**  
**FASCIA C**

**CLOVER**  
**LUNA**  
**FLAVOUR**  
**LACCATO**  
**OPACO**

## Finiture "BOISERIE"

"BOISERIE" finishes



**Desert (opz.D)**

Desert

**N.B.: riferimento immagine  
(opz.8941) UV**

Note: reference immagine  
(opt.8941) UV

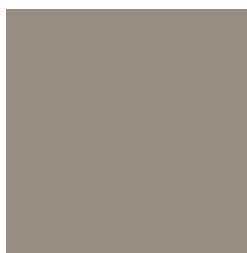

**Stone Grey (opz.G)**

Grey Stone

**N.B.: riferimento immagine  
melaminico (opz.9650)**

Note: reference immagine  
melamine (opt.9650)



**Silver Dark (opz.S)**

Dark Silver

# TERMINALI COVER

## COVER END UNITS

Terminale isola H 75  
zoccolo H 13

End unit island H 75 plinth H 13

**N.B.: possibilità di inserimento  
luce sul cielo, per alimentatore  
vedi listino luci L&S**

Note: possibility to insert light on top,  
for the power supply see L&S light  
pricelist

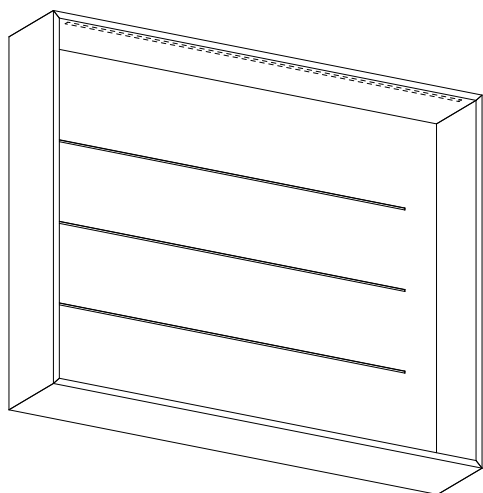

**N.B.: Schienale non rifinito, non progettare a sbalzo  
rispetto alle basi**

Unfinished back panel, do not design cantilever  
than the base unit

L 16,8 H 75 P 93,5  
Luce 11,8W

W 16,8 H 75 D 93,5  
Light 11,8W

**CODICE**  
CODE No.

**ROUND**  
PET

**CLOVER**  
IMP.  
FASCIA A

**CLOVER**  
IMP.  
FASCIA B

**FLAVOUR**  
IMP.  
FASCIA B

**FLAVOUR**  
IMP.  
FASCIA C

**CLOVER**  
FLAVOUR  
LACCATO  
OPACO

**086SHF59**  
**08618326**

## Finiture "BOISERIE"

"BOISERIE" finishes

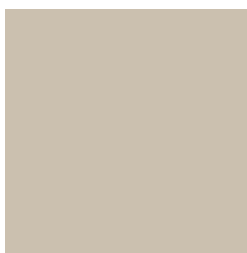

**Desert (opz.D)**

Desert

**N.B.: riferimento immagine  
(opz.8941) UV**

Note: reference immagine  
(opt.8941) UV

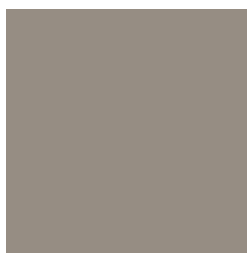

**Stone Grey (opz.G)**

Grey Stone

**N.B.: riferimento immagine  
melaminico (opz.9650)**

Note: reference immagine  
melamine (opt.9650)



**Silver Dark (opz.S)**

Dark Silver

# TERMINALI COVER

## COVER END UNITS

**Terminale isola H 84  
zoccolo H 6**

End unit island H 84 plinth H 6

**N.B.: possibilità di inserimento  
luce sul cielo, per alimentatore  
vedi listino luci L&S**

Note: possibility to insert light on top, for the  
power supply see L&S light pricelist

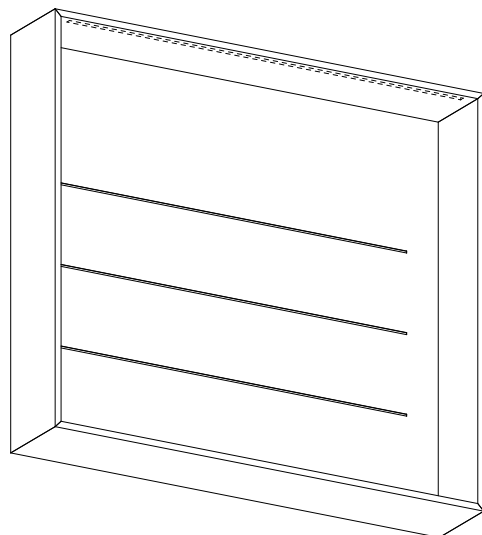

**N.B.: Schienale non rifinito, non progettare a sbalzo  
rispetto alle basi**

Unfinished back panel, do not design cantilever  
than the base unit

L 16,8 H 84 P 93,5  
Luce 11,8W

W 16,8 H 84 D 93,5  
Light 11,8W

**CODICE**  
*CODE No.*

**ROUND**  
**PET**

**OLTRE**  
**IMP.**

**FLAVOUR**  
**IMP.**  
**FASCIA B**

**FLAVOUR**  
**IMP.**  
**FASCIA C**

**OLTRE**  
**FLAVOUR**  
**LACCATO**  
**OPACO**

**086SHF67**  
**08618326**

## Finiture "BOISERIE"

"BOISERIE" finishes

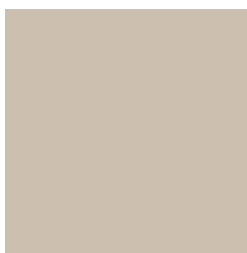

**Desert (opz.D)**

Desert

**N.B.: riferimento immagine  
(opz.8941) UV**

Note: reference immagine  
(opt.8941) UV

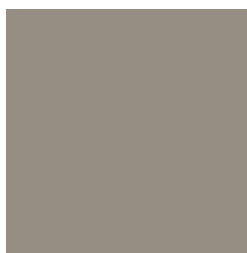

**Stone Grey (opz.G)**

Grey Stone

**N.B.: riferimento immagine  
melaminico (opz.9650)**

Note: reference immagine  
melamine (opt.9650)

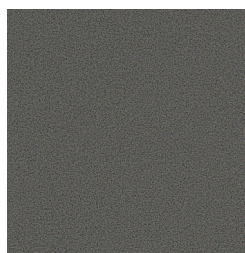

**Silver Dark (opz.S)**

Dark Silver

# TERMINALI COVER

## COVER END UNITS

**Terminale cover con boiserie per colonna H 204**  
**N.B.: possibilità di inserimento luci sui fianchi, per alimentatore vedi listino luci L&S**

Cover end unit with boiserie for tall cabinet H 204  
 Note: possibility to insert lights on side panels, for the power supply see L&S light pricelist

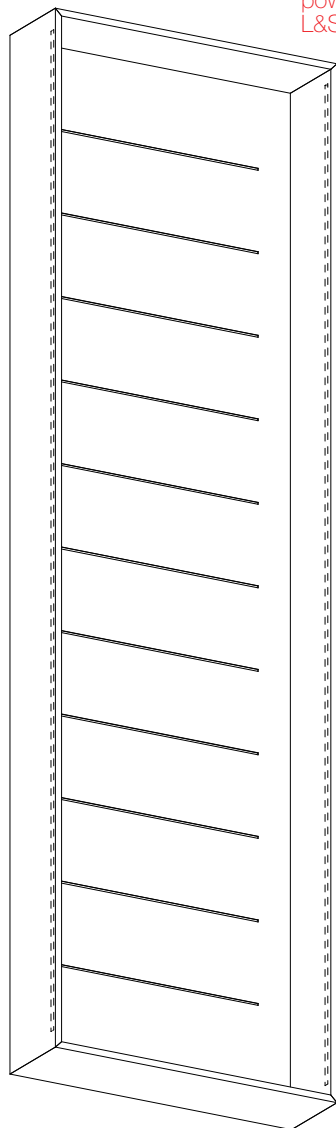

L 16,8 H 204 P 60 DX  
 L 16,8 H 204 P 60 SX  
 Luce nr.2 54W

W 16,8 H 204 D 60 DX  
 W 16,8 H 204 D 60 SX  
 Light nr.2 54W

**CODICE**  
**CODE No.**

**ROUND**  
**PET**

**CLOVER**  
**IMP.**  
**FASCIA A**

**CLOVER**  
**IMP.**  
**FASCIA B**

**LUNA**  
**IMP.**  
**FASCIA A**

**LUNA**  
**IMP.**  
**FASCIA B**

**FLAVOUR**  
**IMP.**  
**FASCIA B**

**FLAVOUR**  
**IMP.**  
**FASCIA C**

**CLOVER**  
**LUNA**  
**FLAVOUR**  
**LACCATO**  
**OPACO**

**086SHF201**  
**086SHF202**  
**08618327**

## Finiture "BOISERIE"

"BOISERIE" finishes

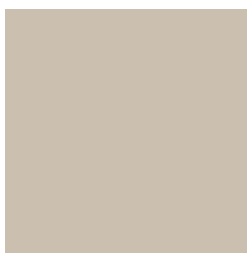

**Desert (opz.D)**

Desert

**N.B.: riferimento immagine (opz.8941) UV**

Note: reference immagine (opt.8941) UV



**Stone Grey (opz.G)**

Grey Stone

**N.B.: riferimento immagine melaminico (opz.9650)**

Note: reference immagine melamine (opt.9650)



**Silver Dark (opz.S)**

Dark Silver

# TERMINALI COVER

## COVER END UNITS

**Terminale cover con boiserie per colonna H 216**  
**N.B.: possibilità di inserimento luci sui fianchi, per alimentatore vedi listino luci L&S**

Cover end unit with boiserie for tall cabinet H 216  
 Note: possibility to insert lights on side panels, for the power supply see L&S light pricelist

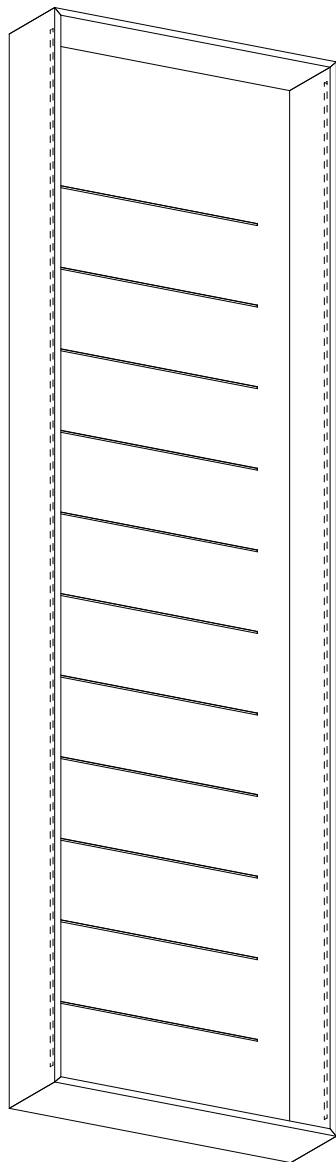

L 16,8 H 216 P 60 DX  
 L 16,8 H 216 P 60 SX  
 Luce nr.2 56,6W

W 16,8 H 216 D 60 DX  
 W 16,8 H 216 D 60 SX  
 Light nr.2 56,6W

**CODICE**  
*CODE No.*

**ROUND**  
**PET**

**OLTRE**  
**IMP.**

**FLAVOUR**  
**IMP.**  
**FASCIA B**

**FLAVOUR**  
**IMP.**  
**FASCIA C**

**OLTRE**  
**FLAVOUR**  
**LACCATO**  
**OPACO**

**086SHF211**  
**086SHF212**  
**08618328**

## Finiture "BOISERIE"

"BOISERIE" finishes

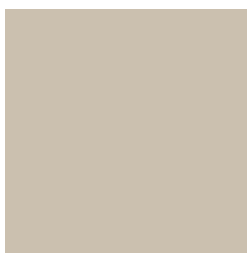

**Desert (opz.D)**

Desert

**N.B.: riferimento immagine (opz.8941) UV**

Note: reference immagine (opt.8941) UV

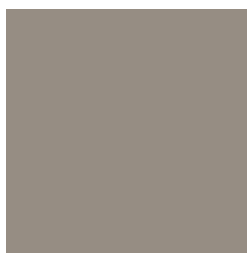

**Stone Grey (opz.G)**

Grey Stone

**N.B.: riferimento immagine melaminico (opz.9650)**

Note: reference immagine melamine (opt.9650)

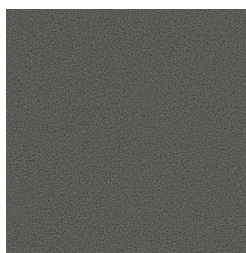

**Silver Dark (opz.S)**

Dark Silver

# COLORI TERMINALI COVER

## COVER END UNITS COLOURS

### COLORI IMPIALLACCIATI MODELLO LUNA

#### LUNA MODEL VENEERED COLOURS

##### FASCIA "A"

###### BAND "A"

 <p>rovere bianco (opz.5429), fiamma orizzontale white oak (opt.5429), horizontal grain</p>	 <p>rovere grigio reale (opz.5432), fiamma orizzontale royal grey oak (opt.5432), horizontal grain</p>	 <p>rovere grigio traffico (opz.5431), fiamma orizzontale traffic grey oak (opt.5431), horizontal grain</p>	 <p>rovere carbon (opz.5434) fiamma orizzontale carbon oak (opt.5434), horizontal grain</p>
 <p>rovere natur (opz.5440) fiamma orizzontale natur oak (opt.5440), horizontal grain</p>	 <p>rovere lino (opz.5430) fiamma orizzontale linen oak (opt.5430), horizontal grain</p>	 <p>rovere moresco (opz.5433) fiamma orizzontale moresco oak (opt.5433), horizontal grain</p>	

##### FASCIA "B"

###### BAND "B"

 <p>noce canaletto (opz.1331) fiamma orizzontale canaletto walnut (opt.1331), horizontal grain</p>
--

### COLORI IMPIALLACCIATI MODELLO CLOVER

#### CLOVER MODEL VENEERED COLOURS



##### FASCIA "A"

###### BAND "A"

 <p>rovere grigio nebbia (opz.5401), fiamma verticale mist grey oak (opt.5401), vertical grain</p>	 <p>rovere polvere (opz.5402), fiamma verticale dust oak (opt.5402), vertical grain</p>	 <p>rovere grafite (opz.5403), fiamma verticale graphite oak (opt.5403), vertical grain</p>	 <p>rovere naturale (opz.5404), fiamma verticale natural oak (opt.5404), vertical grain</p>
 <p>rovere sahara (opz.5416), fiamma orizzontale sahara oak (opt.5416), horizontal grain</p>	 <p>rovere visone (opz.5417), fiamma orizzontale mink oak (opt.5417), horizontal grain</p>	 <p>rovere grigio cenere (opz.5418), fiamma orizzontale ash grey oak (opt.5418), horizontal grain</p>	 <p>rovere lavagna (opz.5419), fiamma orizzontale slate grey oak (opt.5419), horizontal grain</p>
 <p>rovere tabacco (opz.5405), fiamma verticale tobacco oak (opt.5405), vertical grain</p>	 <p>rovere bianco (opz.5415), fiamma orizzontale white oak (opt.5415), horizontal grain</p>	 <p>rovere nero (opz.5420), fiamma orizzontale black oak (opt.5420), horizontal grain</p>	 <p>rovere cenere (opz.5409) fiamma verticale, senza nodo ash oak (opt.5409), vertical grain, without knots</p>
 <p>rovere tan (opz.5408) fiamma verticale, senza nodo tan oak (opt.5408), vertical grain, without knots</p>			

##### FASCIA "B"

###### BAND "B"

 <p>rovere termocotto (opz.5410), fiamma verticale thermo-treated oak (opt.5410), vertical grain</p>	 <p>noce canaletto (opz.1324), fiamma verticale canaletto walnut (opt.1324), vertical grain</p>
--	--

# COLORI TERMINALI COVER

COVER END UNITS COLOURS

## COLORI IMPIALLACCIATI MODELLO OLTRE

OLTRE MODEL VENEERED COLOURS



## COLORI IMPIALLACCIATI MODELLO ROUND

ROUND MODEL VENEERED COLOURS



# COLORI TERMINALI COVER

COVER END UNITS COLOURS

## COLORI IMPIALLACCIATI MODELLO FLAVOUR

FLAVOUR MODEL VENEERED COLOURS

### FASCIA "B"

BAND "B"



### FASCIA "C"

BAND "C"



## COLORI LACCATI OPACHI

MATT LACQUERED COLOURS

### COLORI FREDDI OPACHI SOFT SOFT MATT COLD COLOURS







# COLORI TERMINALI COVER

COVER END UNITS COLOURS

## COLORI LACCATI OPACHI

MATT LACQUERED COLOURS

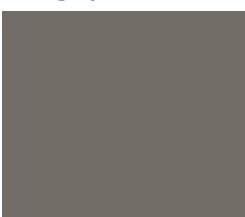
### COLORI CALDI OPACHI SOFT SOFT MATT HOT COLOURS

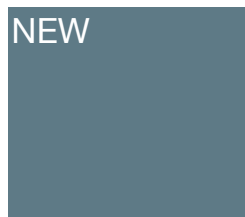
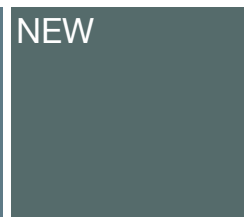
				
bianco caldo (opz.7401) warm white	grigio kenya (opz.9501) kenya grey	bistro (opz.9535) bistro	cannella (opz.8893) cinnamon	grigio reale (opz.95F3) royal grey
				
conchiglia (opz.7403) seashell	lino (opz.9513) linen	creta (opz.9515) clay	rosso persia (opz.8165) persia red	giallo zafferano (opz.8253) saffron yellow
				
grigio lava (opz.95F1) lava grey	polvere (opz.9539) dust	platino (opz.7773) platinum	nocciola (opz.7775) walnut	cuoio (opz.8897) leather
				
grigio piombo (opz.9537) lead grey	grigio quarzo (opz.95F7) quartz grey	azzurro nube (opz.8379) cloud blue	verde bosco (opz.8468) forest green	fumo (opz.9531) smoke
	<b>NEW</b> 	<b>NEW</b> 	<b>NEW</b> 	<b>NEW</b> 
tortora (opz.8993) dove grey	<b>NEW</b> carruba (opz.89L1) carruba	<b>NEW</b> azzurro ottanio (opz.8385) teal blue	<b>NEW</b> verde borneo (opz.8483) borneo green	<b>NEW</b> verde cinabro (opz.8481) cinabro green
<b>NEW</b> 	<b>NEW</b> 	<b>NEW</b> 	<b>NEW</b> 	<b>NEW</b> 
<b>NEW</b> cotto (opz.8887) cooked	<b>NEW</b> rosso (opz.125S) red	<b>NEW</b> granato (opz.8633) ruby red	<b>NEW</b> verde celadon (opz.8485) celadon green	<b>NEW</b> giallo digione (opz.8257) digione yellow

# BOISERIE "QUADRO"

"QUADRO" BOISERIE

Boiserie "QUADRO"

"QUADRO" boiserie

**CODICE**  
*CODE No.*

**DESERT**

**STONE**  
**GREY**

**SILVER**  
**DARK**

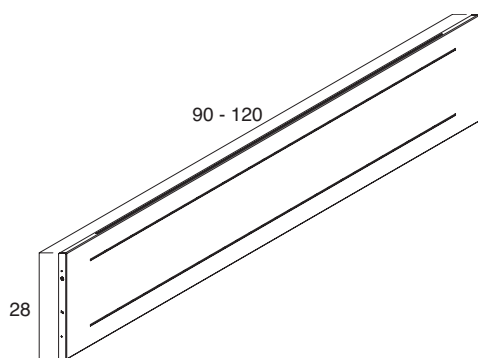
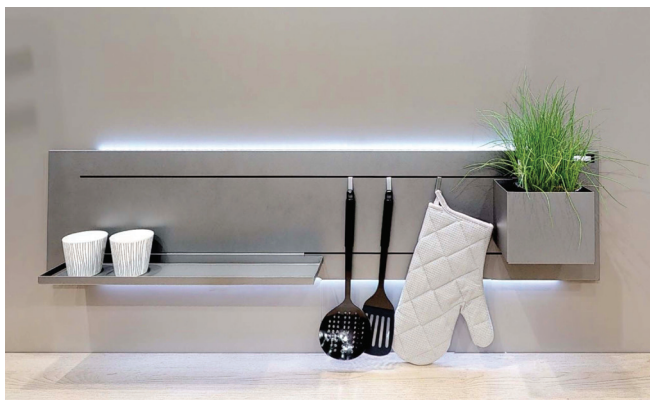

Pannello "QUADRO"  
90X28  
120X28

"QUADRO" back panel  
90x28  
120x28

**086QU090**  
**086QU120**

Pannello "QUADRO" con led touch e  
trasformatore EU  
90X28 DX  
120X28 DX

"QUADRO" back panel with led touch and  
transformer EU  
90x28 RH  
120x28 RH

**086QULD090**  
**086QULD120**

90X28 SX  
120X28 SX

90x28 LH  
120x28 LH

**086QULS090**  
**086QULS120**

Pannello "QUADRO" con led touch e  
trasformatore USA/CANADA  
90X28 DX  
120X28 DX

"QUADRO" back panel with led touch and  
transformer US/CANADA  
90x28 RH  
120x28 RH

**086QULD091**  
**086QULD121**

90X28 SX  
120X28 SX

90x28 LH  
120x28 LH

**086QULS091**  
**086QULS121**

## Finiture "BOISERIE"

"BOISERIE" finishes

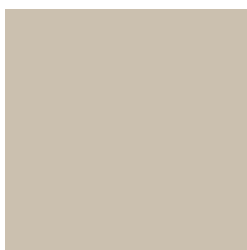

**Desert (opz.D)**

Desert

**N.B.: riferimento immagine**  
**(opz.8941) UV**

Note: reference immagine  
(opt.8941) UV

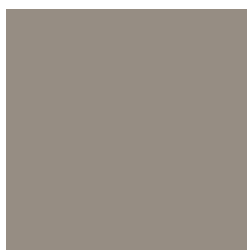

**Stone Grey (opz.G)**

Grey Stone

**N.B.: riferimento immagine**  
**melaminico (opz.9650)**

Note: reference immagine  
melamine (opt.9650)



**Silver Dark (opz.S)**

Dark Silver

# BOISERIE "QUADRO"

"QUADRO" BOISERIE

Nel caso di mancato collegamento ad un punto luce nella parte posteriore del pannello Quadro al fine di nascondere il passaggio del filo in direzione del punto luce esterno si consiglia il posizionamento di un pannello tra base e pensile da scegliere in base alla progettazione.

Vedi esempio sotto

In case of missing connection to a light point in the rear part of the Quadro panel, in order to hide the passage of the wire in the direction of the external light point, it is recommended to place a panel between the base unit and the wall unit to be selected according to the project. See example below

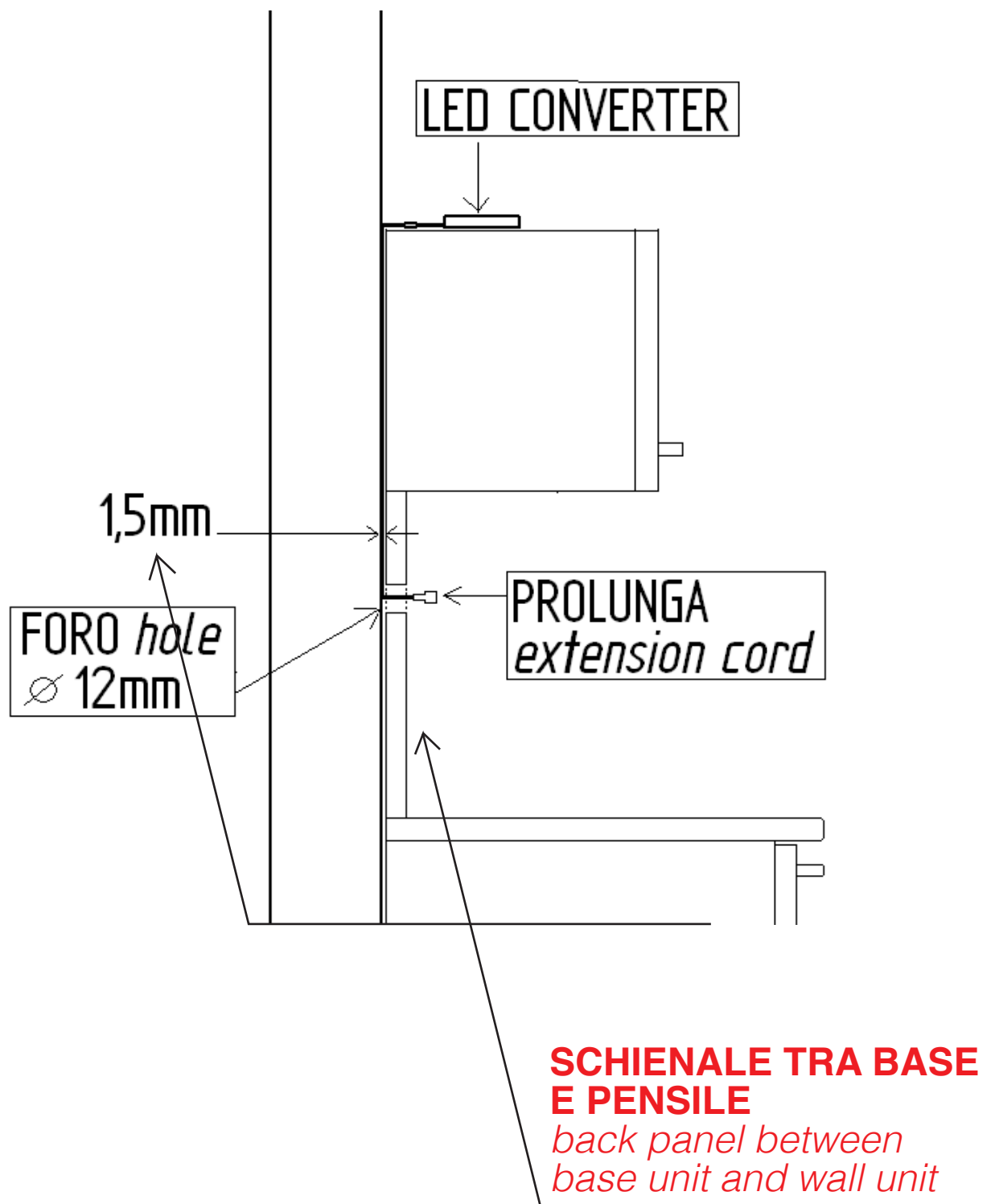

# ACCESSORI

## ACCESSORIES

	<b>Vano a giorno</b>	Open compartment	<b>CODICE CODE No.</b>	<b>DESERT</b>	<b>STONE GREY</b>	<b>SILVER DARK</b>
						
	L 14,8 P 22 H 31,4	W 14,8 D 22 H 31,4	<b>086SHA28</b>			
						
	L 38,8 P 22 H 31,4	W 38,8 D 22 H 31,4	<b>086SHA29</b>			
						
	L 53,8 P 22 H 31,4	W 53,8 D 22 H 31,4	<b>086SHA30</b>			

# ACCESSORI

## ACCESSORIES

		<b>CODICE CODE No.</b>	<b>DESERT</b>	<b>STONE GREY</b>	<b>SILVER DARK</b>
<p><b>Porta Tablet</b></p>  <p>L 20 P 14 H 19,3</p>	<p>Tablet rack</p> <p>W 20 D 14 H 19,3</p>	<b>086SHA23</b>			
<p><b>Porta Riviste</b></p>  <p>L 48,6 P 10,7 H 27,7</p>	<p>Open compartment</p> <p>W 48,6 D 10,7 H 27,7</p>	<b>086SHA26</b>			
<p><b>Parafiamma</b></p>  <p>L 59 P 9 H 21 L 89 P 9 H 21</p>	<p>Firewall</p> <p>W 59 D 9 H 21 W 58 D 9 H 21</p>	<b>086SHA40 086SHA41</b>			

# ACCESSORI

## ACCESSORIES

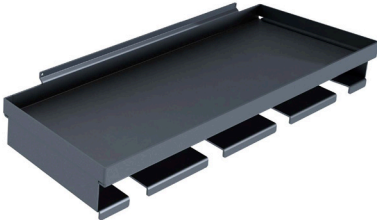
		<b>CODICE CODE No.</b>	<b>DESERT</b>	<b>STONE GREY</b>	<b>SILVER DARK</b>
<b>Mensola Portacalici</b>	Glassholder				
					
L 38,5 P 11,3 H 4	W 38,5 D 11,3 H 4	<b>086SHA20</b>			
<b>Mensola Portacalici</b>	Glassholder				
					
L 53,6 P 11,3 H 4	W 53,6 D 11,3 H 4	<b>086SHA21</b>			
<b>Porta Bottiglie</b>	Bottle rack				
					
L 24 P 18,5 H 8,3	W 24 D 18,5 H 8,3	<b>086SHA24</b>			



# ACCESSORI

ACCESSORIES

<p><b>Gancio</b> Hook</p>  <p>Nr.4 pezzi L 9 P 10 H 3,4</p> <th data-bbox="1098 159 1230 824"><p><b>CODICE</b> <i>CODE No.</i></p><p><b>086SHA27</b></p><th data-bbox="1230 159 1329 824"><p><b>DESERT</b></p><th data-bbox="1329 159 1426 824"><p><b>STONE</b> <b>GREY</b></p><th data-bbox="1426 159 1519 824"><p><b>SILVER</b> <b>DARK</b></p></th></th></th></th>	<p><b>CODICE</b> <i>CODE No.</i></p> <p><b>086SHA27</b></p> <th data-bbox="1230 159 1329 824"><p><b>DESERT</b></p><th data-bbox="1329 159 1426 824"><p><b>STONE</b> <b>GREY</b></p><th data-bbox="1426 159 1519 824"><p><b>SILVER</b> <b>DARK</b></p></th></th></th>	<p><b>DESERT</b></p> <th data-bbox="1329 159 1426 824"><p><b>STONE</b> <b>GREY</b></p><th data-bbox="1426 159 1519 824"><p><b>SILVER</b> <b>DARK</b></p></th></th>	<p><b>STONE</b> <b>GREY</b></p> <th data-bbox="1426 159 1519 824"><p><b>SILVER</b> <b>DARK</b></p></th>	<p><b>SILVER</b> <b>DARK</b></p>
<p><b>Porta Carta</b> Paper rack</p>  <p>L 24 P 8,3 H 10,8</p>	<p><b>086SHA25</b></p>			
<p><b>Mensola Portacoltelli</b> Knife rack</p>  <p>L 41,6 P 15 H 5,8</p>	<p><b>086SHA22</b></p>			

# ACCESSORI

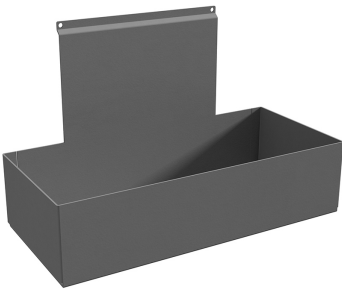
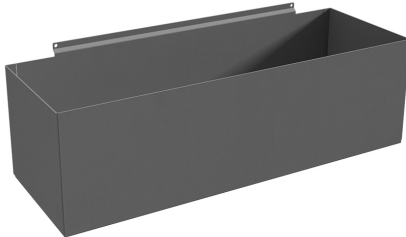
## ACCESSORIES

<b>Mensola</b>	Rack	<b>CODICE</b> <i>CODE No.</i>	<b>DESERT</b>	<b>STONE</b> <b>GREY</b>	<b>SILVER</b> <b>DARK</b>
 <p>L 20 P 9 H 12,8</p>	W 20 D 9 H 12,8	<b>086SHA01</b>			
 <p>L 32 P 11 H 9,7</p>	W 32 D 11 H 9,7	<b>086SHA05</b>			
 <p>L 16,5 P 13,5 H 13,5</p>	W 16,5 D 13,5 H 13,5	<b>086SHA06</b>			



# ACCESSORI

## ACCESSORIES

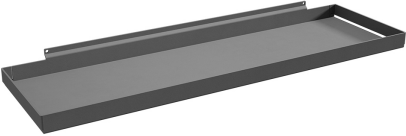
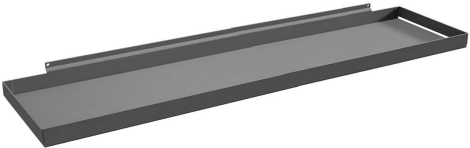
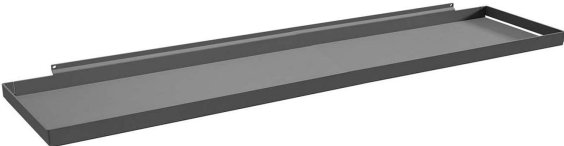
<b>Ripiano</b> Shelf	<b>CODICE</b> <i>CODE No.</i>	<b>DESERT</b>	<b>STONE</b> <b>GREY</b>	<b>SILVER</b> <b>DARK</b>
  L 38,6 P 11,3 H 1,6 W 38,6 D 11,3 H 1,6	<b>086SHA10</b>			
  L 53,6 P 11,3 H 1,6 W 53,6 D 11,3 H 1,6	<b>086SHA11</b>			
  L 83,6 P 11,3 H 1,6 W 83,6 D 11,3 H 1,6	<b>086SHA12</b>			

# ACCESSORI

ACCESSORIES

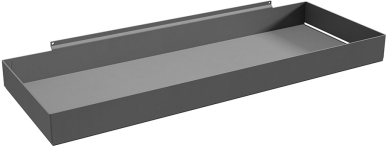
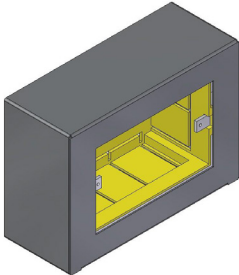
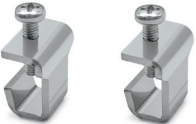
<p><b>Ripiano</b> Shelf</p>  <p>L 41,6 P 15 H 3,4 W 41,6 D 15 H 3,4</p>	<p><b>CODICE</b> CODE No.</p>	<p><b>DESERT</b></p>	<p><b>STONE</b> <b>GREY</b></p>	<p><b>SILVER</b> <b>DARK</b></p>
<p><b>Presa elettrica per boiserie</b> Electrical socket for boiserie</p> <p><b>N.B.: schema fissaggio all'interno dell'imballo</b> Note: fixing diagram inside the packaging</p> 	<p><b>086SHA15</b></p>			
<p><b>Kit ferramenta per bloccaggio pannello telescopico</b> Hardware kit for telescopic panel locking</p> <p><b>N.B.: per boiserie in appoggio</b> Note: boiserie on support</p>  <p>Nr.2 pezzi Nr.2 pieces</p>	<p><b>086SHA45</b></p>			

# ACCESSORI

## ACCESSORIES

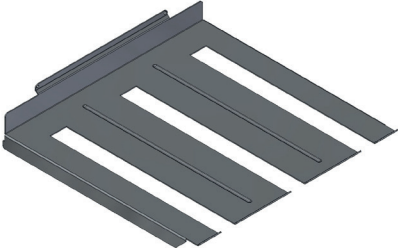
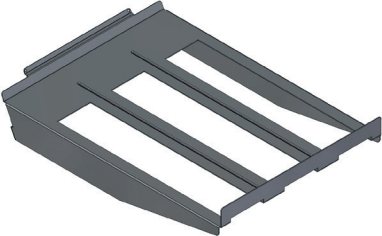
		<b>Compensatore ad "U"</b> H max 1319 mm realizzato a misura in altezza come pannello	"U" shaped compensator max height 1319 mm manufactured in the same height as the panel	<b>CODICE</b> <i>CODE No.</i>	<b>DESERT</b>	<b>STONE</b> <b>GREY</b>	<b>SILVER</b> <b>DARK</b>
		Larghezza mm 12 Larghezza mm 30 Larghezza mm 50	Length mm 12 Length mm 30 Length mm 50	<b>086SHC12</b> <b>086SHC30</b> <b>086SHC50</b>			
		<b>Portacalici</b>	Glassholder				
L 24,3 P 24 H 3,5		W 24,3 D 24 H 3,5		<b>086SHA31</b>			
		<b>Porta Bottiglie</b>	Bottle rack				
L 24,3 P 28,1 H 15,7		W 24,3 D 28,1 H 15,7		<b>086SHA32</b>			

# COLONNA COVER

## COVER END COLUMN

Colonna cover con boiserie  
H 204 accessoriata  
**N.B.: possibilità di inserimento  
luci sui fianchi, per alimentatore  
vedi listino luci L&S**

Cover column with  
boiserie H 204  
equipped  
Note: possibility  
to insert lights on  
side panels, for the  
power supply see  
L&S light pricelist

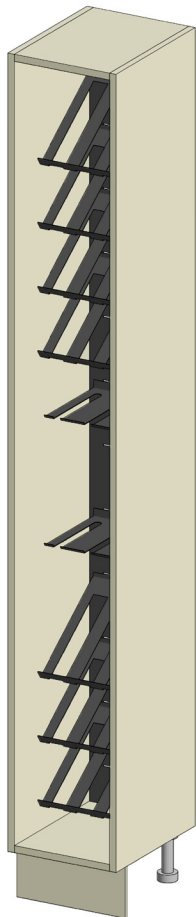

L 30 H 204 P 38  
Luce nr.2 54W

W 30 H 204 D 38  
Light nr.2 54W

**086SHE200**  
**08618327**

**CODICE**  
*CODE No.*

**FASCIA**  
**1**  
MELAMINICO  
FASCIA A

**FASCIA**  
**2**  
MELAMINICO  
FASCIA B  
LACCATO UV

**FASCIA**  
**3**  
WOOD  
MATHERA  
PET FASCIA A  
ALKORCEL

**FASCIA**  
**4**  
PET  
FASCIA B

**FASCIA**  
**5**  
LACCATO  
OPACO

**FASCIA**  
**6**  
IMPIALLAC.  
FASCIA A

**FASCIA**  
**7**  
IMPIALLAC.  
FASCIA B

**FASCIA**  
**8**  
IMPIALLAC.  
FASCIA C

### Modelli disponibili Available models

**Fascia 1: Unica, Immagina, Tablet, Rewind**

Bend 1

**Fascia 2: Unica, Immagina Laccata, Tablet Laccata**

Bend 2

**Fascia 3: Immagina Wood, Immagina Mathera, Tablet Wood, Round, Smart fascia A**

Bend 3

**Fascia 4: Smart fascia B**

Bend 4

**Fascia 5: Clover, Flavour, Oltre, Luna, Contempo**

Bend 5

**Fascia 6: Flavour, Contempo**

Bend 6

**Fascia 7: Flavour, Luna, Clover**

Bend 7

**Fascia 8: Luna, Clover**

Bend 8

# COLONNA COVER

## COVER END COLUMN

Colonna cover con boiserie H 216 accessoriata  
**N.B.: possibilità di inserimento luci sui fianchi, per alimentatore vedi listino luci L&S**

Cover column with boiserie H 216 equipped  
 Note: possibility to insert lights on side panels, for the power supply see L&S light pricelist

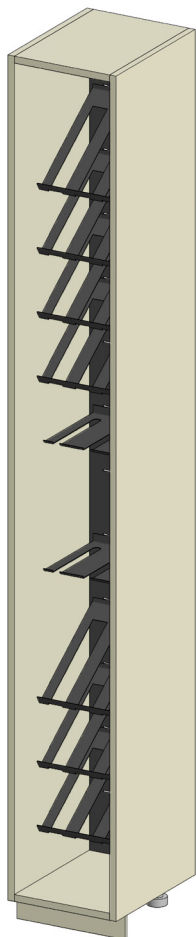

L 30 H 216 P 38  
 Luce nr.2 54W

W 30 H 216 D 38  
 Light nr.2 54W

**086SHE201**  
**08618327**

**CODICE**  
*CODE No.*

**FASCIA**  
**1**  
 MELAMINICO  
 FASCIA A

**FASCIA**  
**2**  
 MELAMINICO  
 FASCIA B  
 LACCATO UV

**FASCIA**  
**3**  
 WOOD  
 MATHERA  
 PET FASCIA A  
 ALKORCEL

**FASCIA**  
**4**  
 PET  
 FASCIA B

**FASCIA**  
**5**  
 LACCATO  
 OPACO

**FASCIA**  
**6**  
 IMPIALLAC.  
 FASCIA A

**FASCIA**  
**7**  
 IMPIALLAC.  
 FASCIA B

**FASCIA**  
**8**  
 IMPIALLAC.  
 FASCIA C

### Modelli disponibili Available models

#### Fascia 1: Immagina, Tablet

Bend 1

#### Fascia 2: Immagina Laccata, Tablet Laccata

Bend 2

#### Fascia 3: Immagina Wood, Immagina Mathera, Tablet Wood, Round

Bend 3

#### Fascia 4: —

Bend 4

#### Fascia 5: Flavour, Oltre

Bend 5

#### Fascia 6: Flavour

Bend 6

#### Fascia 7: Flavour, Oltre

Bend 7

#### Fascia 8: —

Bend 8

CUCINE  
**LUBE**

GRUPPO LUBE



**CREO**  
KITCHENS

# Dama







# ACCESSORI "DAMA"

"DAMA" ACCESSORIES

	<b>Cremagliera da parete in alluminio verniciato</b>	Aluminium painted wall rack system	<b>CODICE</b> <i>CODE No.</i>					
			H 60 L 60 Bianco Grigio Selce Silver Dark Nero					
			H 60 W 60 White Flint Grey Dark Silver Black	<b>08600780W</b> <b>08600780G</b> <b>08600780SD</b> <b>08600780N</b>				
			H 60 L 90 Bianco Grigio Selce Silver Dark Nero	H 60 W 90 White Flint Grey Dark Silver Black	<b>08600781W</b> <b>08600781G</b> <b>08600781SD</b> <b>08600781N</b>			
			H 60 L 120 Bianco Grigio Selce Silver Dark Nero	H 60 W 120 White Flint Grey Dark Silver Black	<b>08600782W</b> <b>08600782G</b> <b>08600782SD</b> <b>08600782N</b>			
						H 72 L 60 Bianco Grigio Selce Silver Dark Nero		
						H 72 W 60 White Flint Grey Dark Silver Black	<b>08600785W</b> <b>08600785G</b> <b>08600785SD</b> <b>08600785N</b>	
						H 72 L 90 Bianco Grigio Selce Silver Dark Nero	H 72 W 90 White Flint Grey Dark Silver Black	<b>08600786W</b> <b>08600786G</b> <b>08600786SD</b> <b>08600786N</b>
						H 72 L 120 Bianco Grigio Selce Silver Dark Nero	H 72 W 120 White Flint Grey Dark Silver Black	<b>08600787W</b> <b>08600787G</b> <b>08600787SD</b> <b>08600787N</b>
								
H 72 W 60 White Flint Grey Dark Silver Black	<b>08600790W</b> <b>08600790G</b> <b>08600790SD</b> <b>08600790N</b>							
H 96 L 90 Bianco Grigio Selce Silver Dark Nero	H 72 W 90 White Flint Grey Dark Silver Black	<b>08600791W</b> <b>08600791G</b> <b>08600791SD</b> <b>08600791N</b>						
H 96 L 120 Bianco Grigio Selce Silver Dark Nero	H 72 W 120 White Flint Grey Dark Silver Black	<b>08600792W</b> <b>08600792G</b> <b>08600792SD</b> <b>08600792N</b>						

# ACCESSORI "DAMA"



"DAMA" ACCESSORIES

	<p><b>Set 3 ganci in alluminio verniciato</b></p>	<p>Kit of 3 aluminium painted hooks</p>	<p><b>CODICE / CODE No.</b></p>	
	<p>Bianco Grigio Selce Silver Dark Nero</p>	<p>White Flint Grey Dark Silver Black</p>	<p><b>08600795W 08600795G 08600795SD 08600795N</b></p>	
	<p><b>Set 3 ganci portapentole in alluminio verniciato</b></p>	<p>Kit of 3 aluminium painted pan holder hooks</p>		
	<p>Bianco Grigio Selce Silver Dark Nero</p>	<p>White Flint Grey Dark Silver Black</p>	<p><b>08600796W 08600796G 08600796SD 08600796N</b></p>	
	<p><b>Portarotolo in alluminio verniciato con corpo in legno faggio</b></p>	<p>Aluminium roll holder Painted, with beech wooden body</p>		
	<p>Bianco Grigio Selce Silver Dark Nero</p>	<p>White Flint Grey Dark Silver Black</p>	<p><b>08600797W 08600797G 08600797SD 08600797N</b></p>	
	<p><b>Portabottiglie con binario portacalici</b></p>	<p>Bottles rack with stem glasses holder</p>		
	<p>Bianco Grigio Selce Silver Dark Nero</p>	<p>White Flint Grey Dark Silver Black</p>	<p><b>08600798W 08600798G 08600798SD 08600798N</b></p>	



# ACCESSORI "DAMA"

"DAMA" ACCESSORIES

	<p><b>Sacchetti contenitori</b> Set 3 ganci in alluminio verniciato non compreso da ordinare separatamente</p> <p>Container bags Kit of 3 painted aluminium hooks is not included, must be ordered separately</p>	<p><b>CODICE / CODE No.</b></p> <p><b>08600800G</b> <b>08600800M</b></p> <p><b>08600799G</b> <b>08600799M</b></p>	
	<p><b>Mensola in alluminio verniciato</b></p> <p>Aluminium painted shelf</p>	<p><b>08600801W</b> <b>08600801G</b> <b>08600801SD</b> <b>08600801N</b></p> <p><b>08600802W</b> <b>08600802G</b> <b>08600802SD</b> <b>08600802N</b></p> <p><b>08600803W</b> <b>08600803G</b> <b>08600803SD</b> <b>08600803N</b></p>	



# ACCESSORI "DAMA"

"DAMA" ACCESSORIES

**Portabarattoli**  
L 27 P 14 H 7,5

Jar rack  
W 27 D 14 H 7,5

**CODICE / CODE No.**

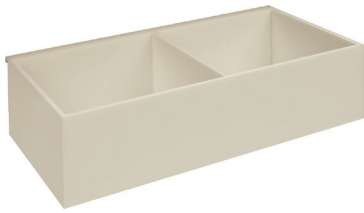

**Adattatore per portabarattoli**  
Jar rack adapter

Bianco  
Grigio Selce  
Silver Dark  
Nero

White  
Flint Grey  
Dark Silver  
Black

**08600794W**  
**08600794G**  
**08600794SD**  
**08600794N**

**Colori opachi disponibili per portabarattoli**

Available matt colours for Jar rack

bianco assoluto  
(opz.740)  
white absolute

conchiglia  
(opz.7403)  
seashell

grigio traffico  
(opz.9511)  
traffic grey

tortora  
(opz.8993)  
dove grey

nero  
(opz.7892)  
black



GRUPPOLUBE



CANALI ATTREZZATI

2023

# MATERIALI

## *MATERIALS*

---

### **2 Materiali | *Materials***

4 Canale a incasso | Low depth back section

16 Canale in appoggio | *Lay-on back section*

24 Alzata in appoggio | *Lay-on double back section*

30 Finiture | *Finishings*



ADATTO AL CONTATTO CON ALIMENTI  
SUITABLE FOR FOODSTUFF CONTACT



ANTI GRAFFIO  
RESISTANT TO SCRATCHES



RESISTENTE AD ACQUA E VAPORE  
RESISTANT TO WATER AND STEAM



ANTI IMPRONTE  
ANTI-FINGERPRINTS



RESISTENTE AI SOLVENTI  
RESISTANT TO ACID SOLVENTS



ECCELLENTI PROPRIETÀ IGIENICHE  
EXCELLENT HYGIENIC PROPERTIES

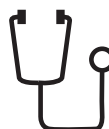

PROPRIETÀ ANTI BATTERICHE  
ANTI-BACTERIAL PROPERTIES



ANTISTATICO  
ANTISTATIC

*Un design semplice e iconico, e un uso di materiali d'avanguardia, sono le principali caratteristiche che rendono il sistema BelNet innovativo e pragmatico. La scelta dell'utilizzo del laminato compatto in spessore 4mm come materiale per la realizzazione degli accessori, è frutto di una ricerca accurata che ha avuto come punto di arrivo la selezione di un materiale resistente all'acqua, al vapore, facile da pulire, ma anche ad alta igienicità e con buone proprietà antibatteriche e antigraffio, tutte caratteristiche che rendono questo materiale perfetto se utilizzato al contatto con il cibo.*

A simple yet iconic design and the use of avant-garde materials are the features that make the BelNet system innovative and pragmatic. The choice to use compact laminate as the main component of our kitchen accessories is fruit of an extensive research aimed to find a material that not only is water and steam resistant, durable and easy to clean, but also a material with highly hygienic and antibacterial properties, that is at the same time scratch resistant and particularly apt to be in contact with food and moisture.



POSSIBILITÀ DI PERSONALIZZAZIONE  
POSSIBLE TO CUSTOMIZE



FACILE DA PULIRE  
EASY TO CLEAN

# CANALE A INCASSO

## *LOW DEPTH BACK SECTION*

---

2 Materiali | *Materials*

**4 Canale a incasso | *Low depth back section***

16 Canale in appoggio | *Lay-on back section*

24 Alzata in appoggio | *Lay-on double back section*

30 Finiture | *Finishings*



*Disegnato per creare uno spazio contenitivo sul top della cucina, il canale attrezzato ad incasso porta una organizzazione e una accessibilità estremamente interessanti a questa parte della cucina.*

*Realizzato in differenti lunghezze, questo canale attrezzato può essere accessorato con tutti gli elementi della linea BelNet 472 con l'aggiunta dell'opzione del vassoio elettrificato, rivelandosi così ideale per organizzare tutti i tipi e dimensioni di top delle cucine.*

Designed to increase storage space on the kitchen counter, our Low Depth Back Section brings organization and accessibility upfront. Coming in five standard measures, and three standard finishings the Low-Depth Back Section can satisfy every cook's need for practicality.

Equipped with the BelNet 472 inserts, this back section can also be furnished with an exclusive Electricity Tray supplied with two Schuko outlets. Extremely versatile and practical, the Low Depth Back Section not only deepens the kitchen counter, but also brings along an orderly elegance.

**■ CANALE A INCASSO - MODULO CON SCOLO**  
*LOW DEPTH BACK SECTION - MODULE WITH WATER DRAINAGE*

**ESEMPIO DI APPLICAZIONE DEL MODULO SENZA MISCELATORE**  
*EXAMPLE OF APPLICATION OF MODULE WITHOUT INTEGRATED FAUCET*





**CANALE A INCASSO  
MODULO 900 CON SCOLO**

**LOW DEPTH BACK SECTION - MODULE 900 WITH WATER DRAINAGE**



<b>CODICE</b> CODE	<b>FINITURA</b> FINISHING	<b>MODULO (mm)</b> MODULE (mm)	<b>MISURE (mm)</b> MEASURE (mm)
0865C0091G	Ghisa Cast Iron	900	860 x 200
0865C0091S	Silver Dark Dark Silver	900	860 x 200
0865C0091N	Nero Black	900	860 x 200

**\_attacco a scarico acqua  
\_attach to the water discharge**

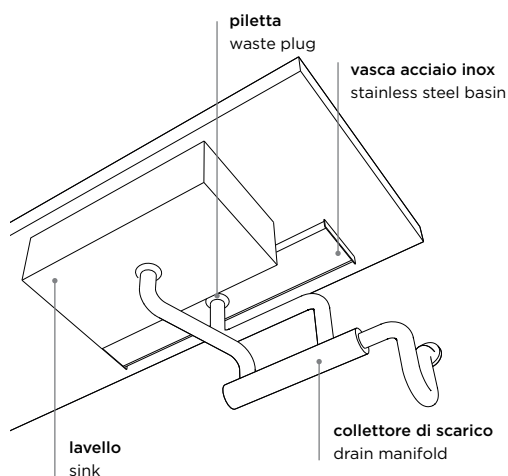
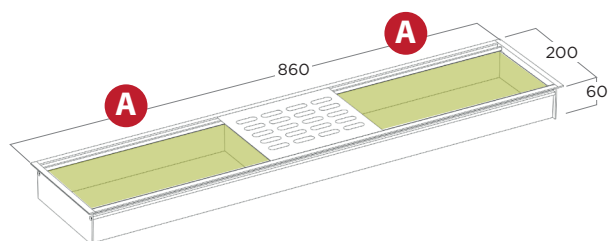

**PORTA PIATTI GHISA**  
PLATE HOLDER CAST IRON

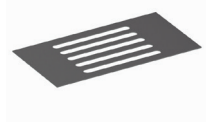

0865C0901G

**PORTA PIATTI SILVER DARK**  
PLATE HOLDER DARK SILVER



0865C0901S

**PORTA PIATTI NERO**  
PLATE HOLDER BLACK



0865C0901N

**GOCCIOLATOIO GHISA**  
DRIP PLAT CAST IRON

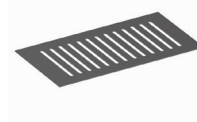

0865C0902G

**GOCCIOLATOIO SILVER DARK**  
DRIP PLAT DARK SILVER

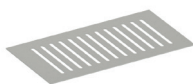

0865C0902S

**GOCCIOLATOIO NERO**  
DRIP PLAT BLACK

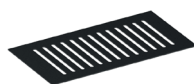

0865C0902N

**VASCHETTA POSATE GHISA**  
TRAY FOR CUTTERY CAST IRON

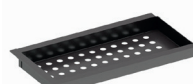

0865C0903G

**VASCHETTA POSATE SILVER DARK**  
TRAY FOR CUTTERY DARK SILVER

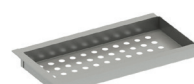

0865C0903S

**VASCHETTA POSATE NERO**  
TRAY FOR CUTTERY BLACK

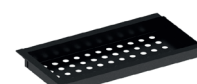

0865C0903N

**CANALE A INCASSO - MODULO CON SCOLO**  
*LOW DEPTH BACK SECTION - MODULE WITH WATER DRAINAGE*

**ESEMPIO DI APPLICAZIONE DEL MODULO CON MISCELATORE**  
*EXAMPLE OF APPLICATION OF MODULE WITH INTEGRATED FAUCET*



## CANALE A INCASSO - MODULO 900 CON SCOLO E ATTACCO PER MISCELATORE

LOW DEPTH BACK SECTION - MODULE 900 WITH WATER DRAINAGE AND ATTACH FOR FAUCET



CODICE CODE	FINITURA FINISHING	MODULO (mm) MODULE (mm)	MISURE (mm) MEASURE (mm)
0865C0092G	Ghisa Cast Iron	900	860 x 200
0865C0092S	Silver Dark Dark Silver	900	860 x 200
0865C0092N	Nero Black	900	860 x 200

Miscelatore non incluso  
Faucet not included

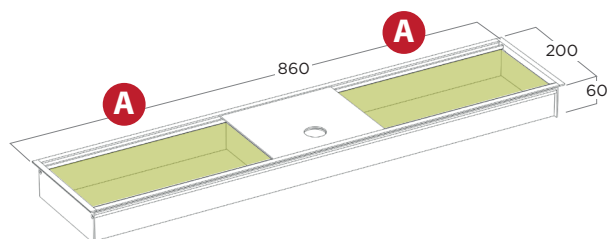

### \_attacco a scarico acqua \_attach to the water discharge

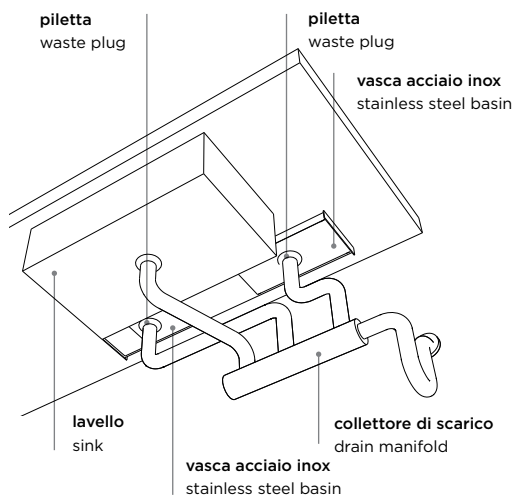

PORTA PIATTI GHISA  
PLATE HOLDER CAST IRON

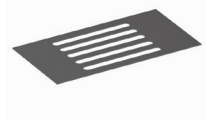

0865C0901G

PORTA PIATTI SILVER DARK  
PLATE HOLDER DARK SILVER



0865C0901S

PORTA PIATTI NERO  
PLATE HOLDER BLACK



0865C0901N

GOCCIOLATOIO GHISA  
DRIP PLAT CAST IRON

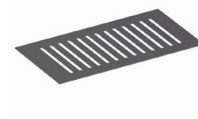

0865C0902G

GOCCIOLATOIO SILVER DARK  
DRIP PLAT DARK SILVER

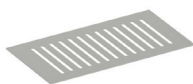

0865C0902S

GOCCIOLATOIO NERO  
DRIP PLAT BLACK



0865C0902N

VASCHETTA POSATE GHISA  
TRAY FOR CUTTERY CAST IRON

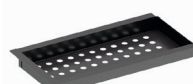

0865C0903G

VASCHETTA POSATE SILVER DARK  
TRAY FOR CUTTERY DARK SILVER

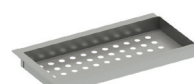

0865C0903S

VASCHETTA POSATE NERO  
TRAY FOR CUTTERY BLACK



0865C0903N

## CANALE A INCASSO - MODULO 900 LOW DEPTH BACK SECTION - MODULE 900

 **A** + **B** oppure **C**

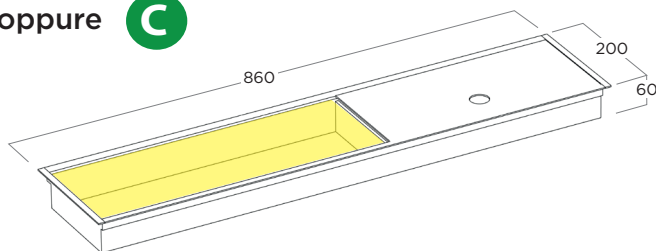

CODICE CODE	FINITURA FINISHING	MODULO (mm) MODULE (mm)	MISURE (mm) MEASURE (mm)
0865C0090G	Ghisa Cast Iron	900	860 x 200
0865C0090S	Silver Dark Dark Silver	900	860 x 200
0865C0090N	Nero Black	900	860 x 200

VASCHETTA UNIVERSALE OAK DARK BROWN  
UNIVERSAL TRAY OAK DARK BROWN

**A**

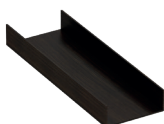

0865C0900

+

**B**

PORTA COLTELLI GHISA  
KNIVES RACK DARK CAST IRON

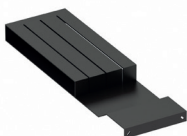

0865C0904G

PORTA OGGETTI GHISA  
OBJECT HOLDERS CAST IRON

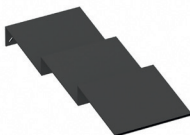

0865C0905G

PORTA SPEZIE GHISA  
SPICE JARS HOLDER CAST IRON



0865C0906G

PORTA BARATTOLI GHISA  
ARS HOLDER CAST IRON



0865C0907G

PORTA COLTELLI SILVER DARK  
KNIVES RACK DARK SILVER

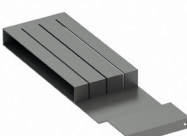

0865C0904S

PORTA OGGETTI SILVER DARK  
OBJECT HOLDERS DARK SILVER

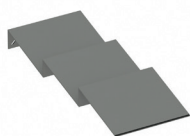

0865C0905S

PORTA SPEZIE SILVER DARK  
SPICE JARS HOLDER DARK SILVER



0865C0906S

PORTA BARATTOLI SILVER DARK  
ARS HOLDER DARK SILVER



0865C0907S

PORTA COLTELLI NERO  
KNIVES RACK BLACK

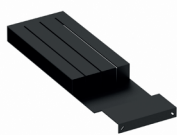

0865C0904N

PORTA OGGETTI NERO  
OBJECT HOLDERS BLACK

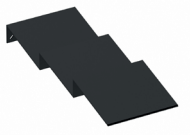

0865C0905N

PORTA SPEZIE NERO  
SPICE JARS HOLDER BLACK



0865C0906N

PORTA BARATTOLI NERO  
ARS HOLDER BLACK



0865C0907N

oppure

**C**

VASCHETTA ELETTTRIFICATA GHISA  
ELECTRICAL TRAY CAST IRON



0865C0908G

VASCHETTA ELETTTRIFICATA SILVER DARK  
ELECTRICAL TRAY DARK SILVER



0865C0908S

VASCHETTA ELETTTRIFICATA NERO  
ELECTRICAL TRAY BLACK



0865C0908N

## CANALE A INCASSO - MODULO 1200

### LOW DEPTH BACK SECTION - MODULE 1200

 **A** + **B** oppure **C**

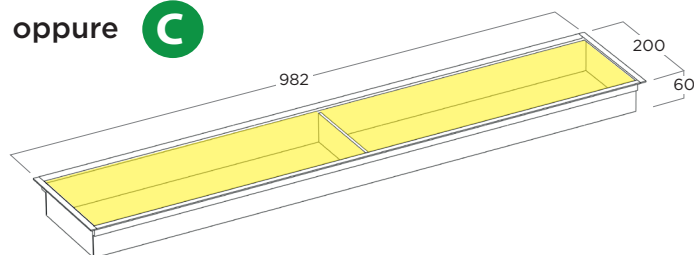

CODICE CODE	FINITURA FINISHING	MODULO (mm) MODULE (mm)	MISURE (mm) MEASURE (mm)
0865C0120G	Ghisa Cast Iron	1200	982 x 200
0865C0120S	Silver Dark Dark Silver	1200	982 x 200
0865C0120N	Nero Black	1200	982 x 200

VASCETTA UNIVERSALE OAK DARK BROWN  
UNIVERSAL TRAY OAK DARK BROWN

**A**

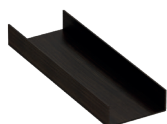

0865C0900

+

**B**

PORTA COLTELLI GHISA  
KNIVES RACK DARK CAST IRON

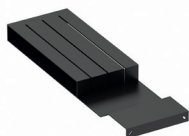

0865C0904G

PORTA OGGETTI GHISA  
OBJECT HOLDERS CAST IRON

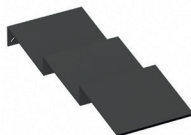

0865C0905G

PORTA SPEZIE GHISA  
SPICE JARS HOLDER CAST IRON



0865C0906G

PORTA BARATTOLI GHISA  
ARS HOLDER CAST IRON



0865C0907G

PORTA COLTELLI SILVER DARK  
KNIVES RACK DARK SILVER

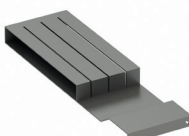

0865C0904S

PORTA OGGETTI SILVER DARK  
OBJECT HOLDERS DARK SILVER

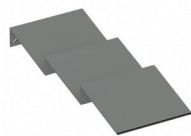

0865C0905S

PORTA SPEZIE SILVER DARK  
SPICE JARS HOLDER DARK SILVER



0865C0906S

PORTA BARATTOLI SILVER DARK  
ARS HOLDER DARK SILVER



0865C0907S

PORTA COLTELLI NERO  
KNIVES RACK BLACK

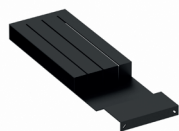

0865C0904N

PORTA OGGETTI NERO  
OBJECT HOLDERS BLACK

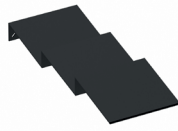

0865C0905N

PORTA SPEZIE NERO  
SPICE JARS HOLDER BLACK



0865C0906N

PORTA BARATTOLI NERO  
ARS HOLDER BLACK



0865C0907N

oppure

**C**

VASCETTA ELETTTRIFICATA GHISA  
ELECTRICAL TRAY CAST IRON



0865C0908G

VASCETTA ELETTTRIFICATA SILVER DARK  
ELECTRICAL TRAY DARK SILVER



0865C0908S

VASCETTA ELETTTRIFICATA NERO  
ELECTRICAL TRAY BLACK



0865C0908N

## CANALE A INCASSO - MODULO 1500 LOW DEPTH BACK SECTION - MODULE 1500

 **A** + **B** oppure **C**

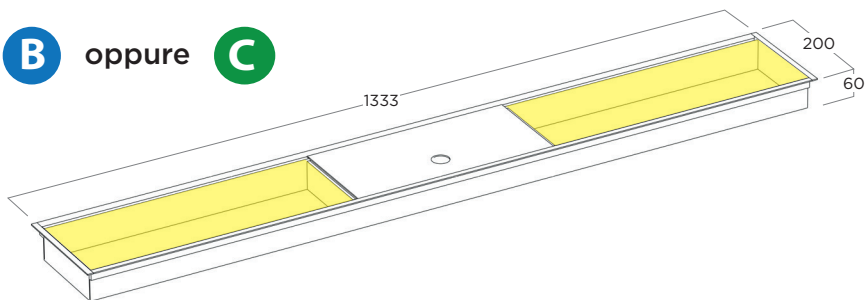

CODICE CODE	FINITURA FINISHING	MODULO (mm) MODULE (mm)	MISURE (mm) MEASURE (mm)
0865C0150G	Ghisa Cast Iron	1500	1333 x 200
0865C0150S	Silver Dark Dark Silver	1500	1333 x 200
0865C0150N	Nero Black	1500	1333 x 200

VASCHETTA UNIVERSALE OAK DARK BROWN  
UNIVERSAL TRAY OAK DARK BROWN

**A**

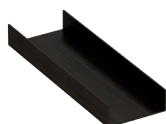

0865C0900

+

**B**

PORTA COLTELLI GHISA  
KNIVES RACK DARK CAST IRON

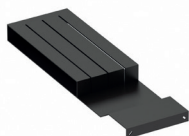

0865C0904G

PORTA OGGETTI GHISA  
OBJECT HOLDERS CAST IRON

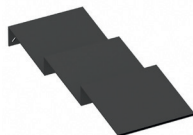

0865C0905G

PORTA SPEZIE GHISA  
SPICE JARS HOLDER CAST IRON



0865C0906G

PORTA BARATTOLI GHISA  
ARS HOLDER CAST IRON



0865C0907G

PORTA COLTELLI SILVER DARK  
KNIVES RACK DARK SILVER

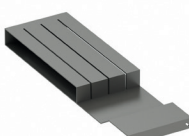

0865C0904S

PORTA OGGETTI SILVER DARK  
OBJECT HOLDERS DARK SILVER

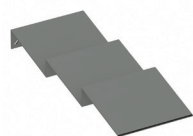

0865C0905S

PORTA SPEZIE SILVER DARK  
SPICE JARS HOLDER DARK SILVER



0865C0906S

PORTA BARATTOLI SILVER DARK  
ARS HOLDER DARK SILVER



0865C0907S

PORTA COLTELLI NERO  
KNIVES RACK BLACK

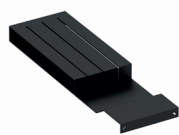

0865C0904N

PORTA OGGETTI NERO  
OBJECT HOLDERS BLACK

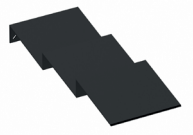

0865C0905N

PORTA SPEZIE NERO  
SPICE JARS HOLDER BLACK



0865C0906N

PORTA BARATTOLI NERO  
ARS HOLDER BLACK



0865C0907N

oppure

**C**

VASCHETTA ELETTTRIFICATA GHISA  
ELECTRICAL TRAY CAST IRON



0865C0908G

VASCHETTA ELETTTRIFICATA SILVER DARK  
ELECTRICAL TRAY DARK SILVER



0865C0908S

VASCHETTA ELETTTRIFICATA NERO  
ELECTRICAL TRAY BLACK



0865C0908N

## CANALE A INCASSO - MODULO 1800

### LOW DEPTH BACK SECTION - MODULE 1800

 **A** + **B** oppure **C**

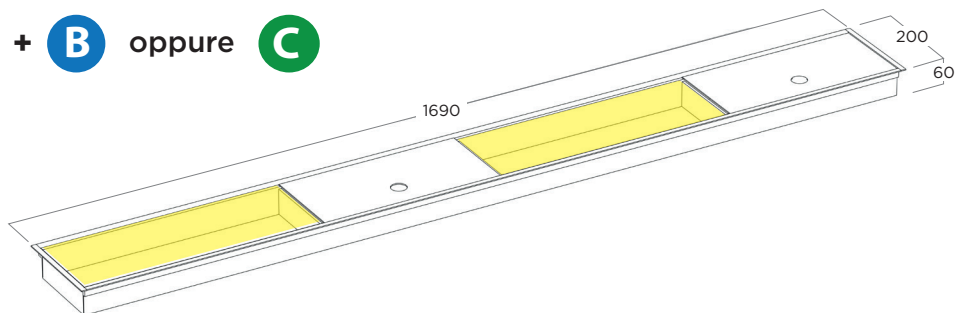

CODICE CODE	FINITURA FINISHING	MODULO (mm) MODULE (mm)	MISURE (mm) MEASURE (mm)
0865C0180G	Ghisa Cast Iron	1800	1690 x 200
0865C0180S	Silver Dark Dark Silver	1800	1690 x 200
0865C0180N	Nero Black	1800	1690 x 200

VASCETTA UNIVERSALE OAK DARK BROWN  
UNIVERSAL TRAY OAK DARK BROWN

**A**

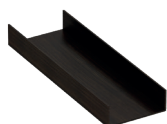

0865C0900

+

**B**

PORTA COLTELLI GHISA  
KNIVES RACK DARK CAST IRON

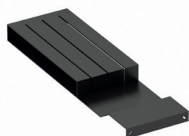

0865C0904G

PORTA OGGETTI GHISA  
OBJECT HOLDERS CAST IRON

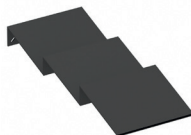

0865C0905G

PORTA SPEZIE GHISA  
SPICE JARS HOLDER CAST IRON



0865C0906G

PORTA BARATTOLI GHISA  
ARS HOLDER CAST IRON



0865C0907G

PORTA COLTELLI SILVER DARK  
KNIVES RACK DARK SILVER

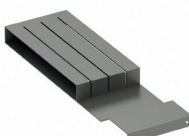

0865C0904S

PORTA OGGETTI SILVER DARK  
OBJECT HOLDERS DARK SILVER

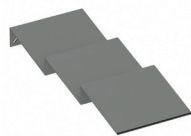

0865C0905S

PORTA SPEZIE SILVER DARK  
SPICE JARS HOLDER DARK SILVER



0865C0906S

PORTA BARATTOLI SILVER DARK  
ARS HOLDER DARK SILVER



0865C0907S

PORTA COLTELLI NERO  
KNIVES RACK BLACK

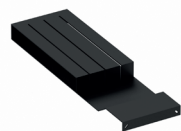

0865C0904N

PORTA OGGETTI NERO  
OBJECT HOLDERS BLACK

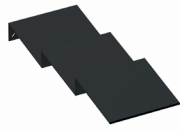

0865C0905N

PORTA SPEZIE NERO  
SPICE JARS HOLDER BLACK



0865C0906N

PORTA BARATTOLI NERO  
ARS HOLDER BLACK



0865C0907N

oppure

**C**

VASCETTA ELETTTRIFICATA GHISA  
ELECTRICAL TRAY CAST IRON



0865C0908G

VASCETTA ELETTTRIFICATA SILVER DARK  
ELECTRICAL TRAY DARK SILVER



0865C0908S

VASCETTA ELETTTRIFICATA NERO  
ELECTRICAL TRAY BLACK



0865C0908N

## CANALE A INCASSO - MODULO 2200 LOW DEPTH BACK SECTION - MODULE 2200

 **A** + **B** oppure **C**

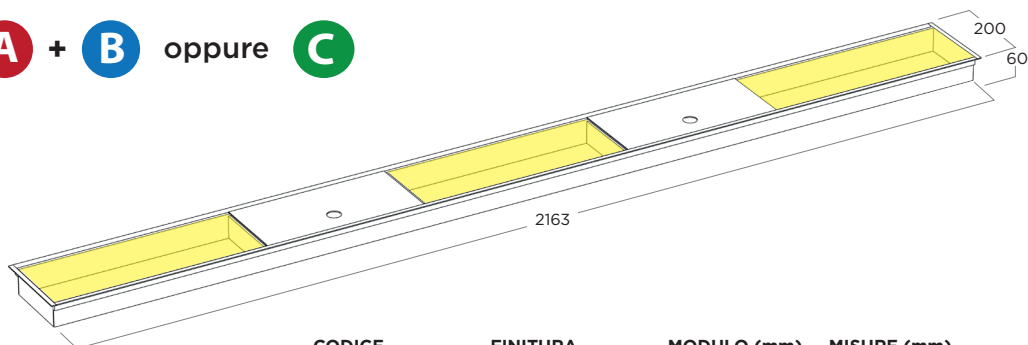

CODICE CODE	FINITURA FINISHING	MODULO (mm) MODULE (mm)	MISURE (mm) MEASURE (mm)
0865C0220G	Ghisa Cast Iron	2200	2163 x 200
0865C0220S	Silver Dark Dark Silver	2200	2163 x 200
0865C0220N	Nero Black	2200	2163 x 200

VASCHETTA UNIVERSALE OAK DARK BROWN  
UNIVERSAL TRAY OAK DARK BROWN

**A**

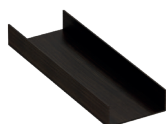

0865C0900

+

**B**

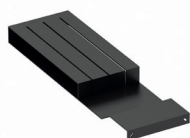

0865C0904G

PORTA COLTELLI GHISA  
KNIVES RACK DARK CAST IRON

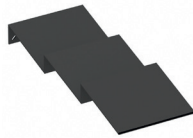

0865C0905G

PORTA OGGETTI GHISA  
OBJECT HOLDERS CAST IRON



0865C0906G

PORTA SPEZIE GHISA  
SPICE JARS HOLDER CAST IRON



0865C0907G

PORTA BARATTOLI GHISA  
ARS HOLDER CAST IRON

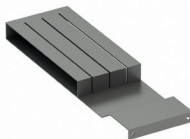

0865C0904S

PORTA COLTELLI SILVER DARK  
KNIVES RACK DARK SILVER

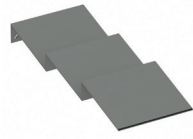

0865C0905S

PORTA OGGETTI SILVER DARK  
OBJECT HOLDERS DARK SILVER



0865C0906S

PORTA SPEZIE SILVER DARK  
SPICE JARS HOLDER DARK SILVER



0865C0907S

PORTA BARATTOLI SILVER DARK  
ARS HOLDER DARK SILVER



0865C0904N

PORTA COLTELLI NERO  
KNIVES RACK BLACK



0865C0905N

PORTA OGGETTI NERO  
OBJECT HOLDERS BLACK



0865C0906N

PORTA SPEZIE NERO  
SPICE JARS HOLDER BLACK



0865C0907N

PORTA BARATTOLI NERO  
ARS HOLDER BLACK

oppure

**C**

VASCHETTA ELETRIFICATA GHISA  
ELECTRICAL TRAY CAST IRON



0865C0908G

VASCHETTA ELETRIFICATA SILVER DARK  
ELECTRICAL TRAY DARK SILVER



0865C0908S

VASCHETTA ELETRIFICATA NERO  
ELECTRICAL TRAY BLACK



0865C0908N



---

**FRESATA NEL TOP**  
**MILLING ON KITCHEN TOP**

**CANALE A INCASSO MODULO 900**  
*LOW DEPTH BACK SECTION - MODULE 900*

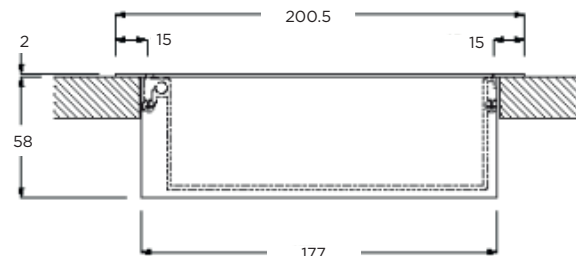
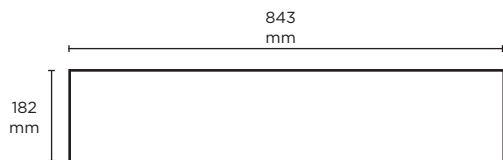

**CANALE A INCASSO MODULO 1200**  
*LOW DEPTH BACK SECTION - MODULE 1200*

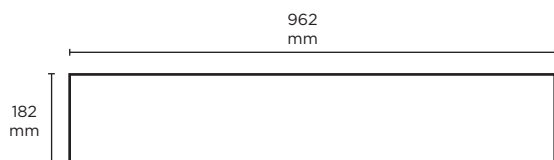

**CANALE A INCASSO MODULO 1500**  
*LOW DEPTH BACK SECTION - MODULE 1500*

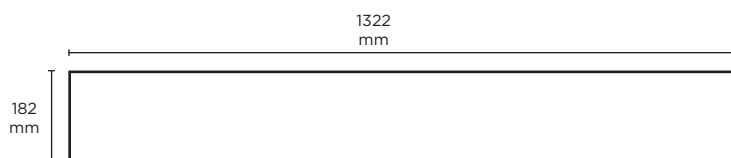

**CANALE A INCASSO MODULO 1800**  
*LOW DEPTH BACK SECTION - MODULE 1800*

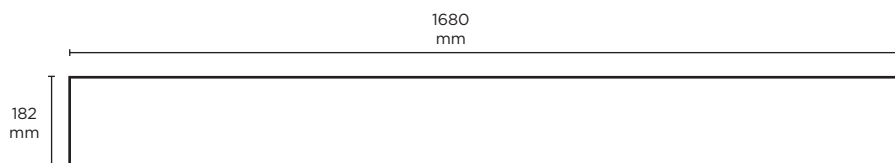

**CANALE A INCASSO MODULO 2200**  
*LOW DEPTH BACK SECTION - MODULE 2200*

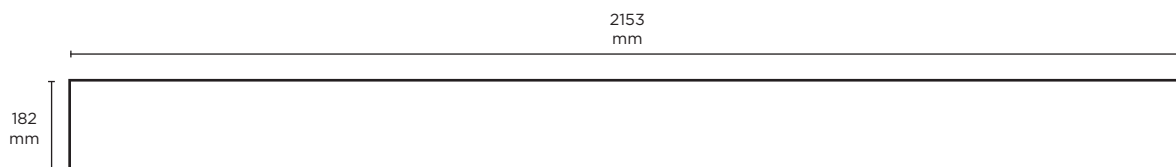

# CANALE IN APPOGGIO

## LAY-ON BACK SECTION

---

2 Materiali | *Materials*

4 Canale a incasso | *Low depth back section*

**16 Canale in appoggio | *Lay-on back section***

24 Alzata in appoggio | *Lay-on double back section*

30 Finiture | *Finishings*



*Disegnato per portare ordine sul top della cucina, il canale attrezzato in appoggio si può posizionare dove più si preferisce proprio perché è solo appoggiato sul top della cucina e fissato grazie ad uno speciale velcro che dà la possibilità di rimuoverlo ogni qualvolta ce ne sia il bisogno.*

*Proprio questa caratteristica di fissaggio, che evita lavorazioni sul top della cucina, lo rende particolarmente semplice da installare anche su una cucina già esistente. Equipaggiato con tutti gli accessori della linea BelNet 472, questo canale attrezzato è estremamente pratico e funzionale, portando carattere anche alle cucine più semplici.*

Designed to bring order on the kitchen counter, the Lay-on Back Section stays where you place it, but can also be moved where you need it, thanks to the practical reusable fastener used to fix it to the counter top. Coming in four standard measures, and three standard colors the Lay-On Back Section can satisfy every cook's need for practicality and orderliness. Equipped with our BelNet 472 inserts, extremely versatile and practical the Lay-On Back Section is the perfect tool to accessorize the kitchen with tidiness and glamour.



## CANALE IN APPOGGIO

### LAY-ON BACK SECTION

*Il fissaggio sul top avviene grazie ad uno speciale velcro che dà la possibilità di rimuoverlo ogni qualvolta ce ne sia il bisogno. Proprio questa caratteristica di fissaggio, che evita lavorazioni sul top della cucina, lo rende particolarmente semplice da installare anche su una cucina già esistente.*

Thanks to the reusable fastener at the bottom, the Lay-On Back Section stays where you put it, but can be moved when and where you need it, without requiring any milling on the kitchen top.

## FACILE DA INSTALLARE SUL TOP DELLA CUCINA

*EASY TO INSTALL ON THE KITCHEN TOP*

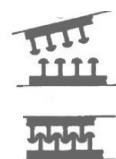
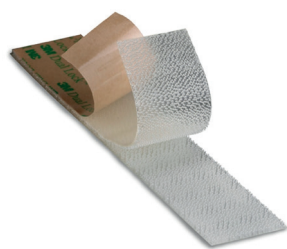

No Screws

No Holes

No Milled

## POSSIBILITÀ DI PERSONALIZZAZIONE

*CUSTOMIZATION AVAILABLE*

*Il canale in appoggio può essere prodotto in misure personalizzate, e può essere fornito anche senza fondo.*

The Lay-On Back Section can be produced in customized measures, and it can be supplied also without bottom panel.

## CANALE IN APPOGGIO - MODULO 900

### LAY-ON BACK SECTION - MODULE 900

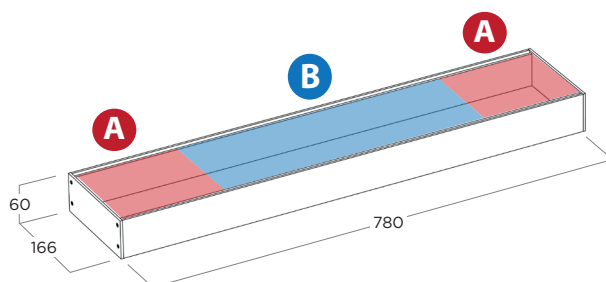

CODICE CODE	FINITURA FINISHING	MODULO (mm) MODULE (mm)	MISURE (mm) MEASURE (mm)
0865C0590G	Ghisa Cast Iron	900	780 x 166 x 60
0865C0590S	Silver Dark Dark Silver	900	780 x 166 x 60
0865C0590N	Nero Black	900	780 x 166 x 60

**A**

PORTA SPEZIE GHISA  
SPICE JARS HOLDER CAST IRON

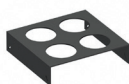

0865C0911G

VASSOIO GHISA  
U TRAY CAST IRON



0865C0910G

PORTA SPEZIE SILVER DARK  
SPICE JARS HOLDER DARK SILVER

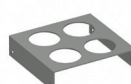

0865C0911S

VASSOIO SILVER DARK  
U TRAY DARK SILVER

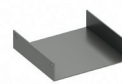

0865C0910S

PORTA SPEZIE NERO  
SPICE JARS HOLDER BLACK



0865C0911N

VASSOIO NERO  
U TRAY BLACK



0865C0910N

PORTA COLTELLI GHISA  
KNIVES RACK DARK CAST IRON

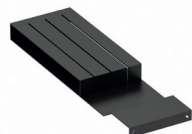

0865C0904G

PORTA OGGETTI GHISA  
OBJECT HOLDERS CAST IRON

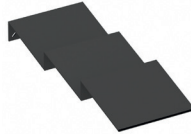

0865C0905G

PORTA SPEZIE GHISA  
SPICE JARS HOLDER CAST IRON



0865C0906G

PORTA BARATTOLI GHISA  
ARS HOLDER CAST IRON



0865C0907G

**B**

PORTA COLTELLI SILVER DARK  
KNIVES RACK DARK SILVER

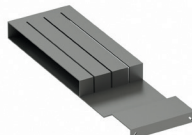

0865C0904S

PORTA OGGETTI SILVER DARK  
OBJECT HOLDERS DARK SILVER

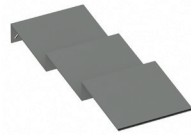

0865C0905S

PORTA SPEZIE SILVER DARK  
SPICE JARS HOLDER DARK SILVER



0865C0906S

PORTA BARATTOLI SILVER DARK  
ARS HOLDER DARK SILVER



0865C0907S

PORTA COLTELLI NERO  
KNIVES RACK BLACK

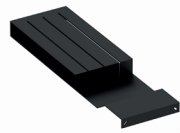

0865C0904N

PORTA OGGETTI NERO  
OBJECT HOLDERS BLACK

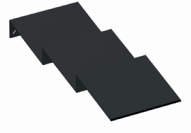

0865C0905N

PORTA SPEZIE NERO  
SPICE JARS HOLDER BLACK



0865C0906N

PORTA BARATTOLI NERO  
ARS HOLDER BLACK

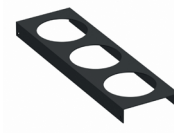

0865C0907N

## CANALE IN APPOGGIO - MODULO 1200

### LAY-ON BACK SECTION - MODULE 1200

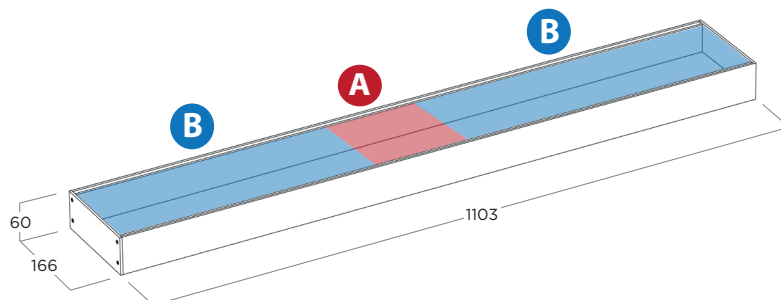

CODICE CODE	FINITURA FINISHING	MODULO (mm) MODULE (mm)	MISURE (mm) MEASURE (mm)
0865C0620G	Ghisa Cast Iron	1200	1103 x 166 x 60
0865C0620S	Silver Dark Dark Silver	1200	1103 x 166 x 60
0865C0620N	Nero Black	1200	1103 x 166 x 60

**A**

PORTA SPEZIE GHISA  
SPICE JARS HOLDER CAST IRON



0865C0911G

VASSOIO GHISA  
U TRAY CAST IRON

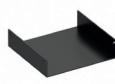

0865C0910G

PORTA SPEZIE SILVER DARK  
SPICE JARS HOLDER DARK SILVER

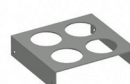

0865C0911S

VASSOIO SILVER DARK  
U TRAY DARK SILVER

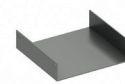

0865C0910S

PORTA SPEZIE NERO  
SPICE JARS HOLDER BLACK



0865C0911N

VASSOIO NERO  
U TRAY BLACK



0865C0910N

PORTA COLTELLI GHISA  
KNIVES RACK DARK CAST IRON

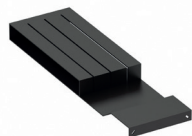

0865C0904G

PORTA OGGETTI GHISA  
OBJECT HOLDERS CAST IRON

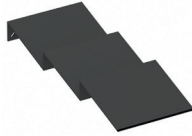

0865C0905G

PORTA SPEZIE GHISA  
SPICE JARS HOLDER CAST IRON



0865C0906G

PORTA BARATTOLI GHISA  
ARS HOLDER CAST IRON



0865C0907G

**B**

PORTA COLTELLI SILVER DARK  
KNIVES RACK DARK SILVER

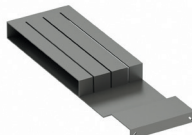

0865C0904S

PORTA OGGETTI SILVER DARK  
OBJECT HOLDERS DARK SILVER

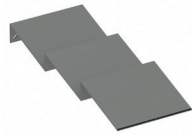

0865C0905S

PORTA SPEZIE SILVER DARK  
SPICE JARS HOLDER DARK SILVER



0865C0906S

PORTA BARATTOLI SILVER DARK  
ARS HOLDER DARK SILVER



0865C0907S

PORTA COLTELLI NERO  
KNIVES RACK BLACK

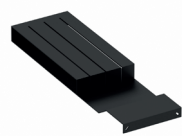

0865C0904N

PORTA OGGETTI NERO  
OBJECT HOLDERS BLACK

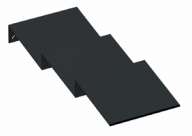

0865C0905N

PORTA SPEZIE NERO  
SPICE JARS HOLDER BLACK



0865C0906N

PORTA BARATTOLI NERO  
ARS HOLDER BLACK



0865C0907N

## CANALE IN APPOGGIO - MODULO 1500 LAY-ON BACK SECTION - MODULE 1500

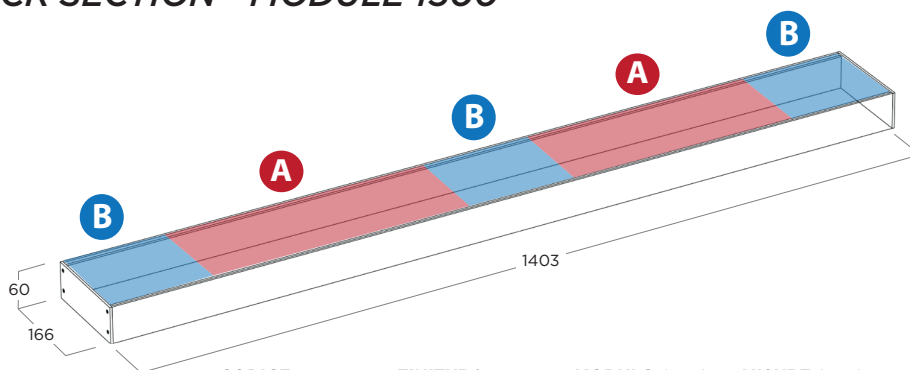

CODICE CODE	FINITURA FINISHING	MODULO (mm) MODULE (mm)	MISURE (mm) MEASURE (mm)
0865C0650G	Ghisa Cast Iron	1500	1403 x 166 x 60
0865C0650S	Silver Dark Dark Silver	1500	1403 x 166 x 60
0865C0650N	Nero Black	1500	1403 x 166 x 60

**A**

PORTA SPEZIE GHISA  
SPICE JARS HOLDER CAST IRON

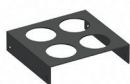

0865C0911G

PORTA SPEZIE NERO  
SPICE JARS HOLDER BLACK



0865C0911N

PORTA COLTELLI GHISA  
KNIVES RACK DARK CAST IRON

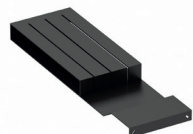

0865C0904G

PORTA COLTELLI SILVER DARK  
KNIVES RACK DARK SILVER

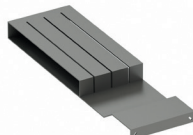

0865C0904S

PORTA COLTELLI NERO  
KNIVES RACK BLACK

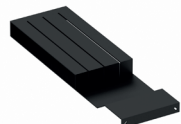

0865C0904N

VASSOIO GHISA  
U TRAY CAST IRON

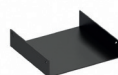

0865C0910G

VASSOIO NERO  
U TRAY BLACK



0865C0910N

PORTA OGGETTI GHISA  
OBJECT HOLDERS CAST IRON

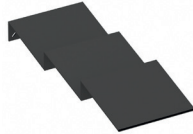

0865C0905G

PORTA OGGETTI SILVER DARK  
OBJECT HOLDERS DARK SILVER

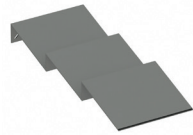

0865C0905S

PORTA OGGETTI NERO  
OBJECT HOLDERS BLACK



0865C0905N

PORTA SPEZIE SILVER DARK  
SPICE JARS HOLDER DARK SILVER

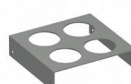

0865C0911S

PORTA SPEZIE GHISA  
SPICE JARS HOLDER CAST IRON



0865C0906G

PORTA SPEZIE SILVER DARK  
SPICE JARS HOLDER DARK SILVER



0865C0906S

PORTA SPEZIE NERO  
SPICE JARS HOLDER BLACK



0865C0906N

VASSOIO SILVER DARK  
U TRAY DARK SILVER

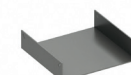

0865C0910S

PORTA BARATTOLI GHISA  
ARS HOLDER CAST IRON



0865C0907G

PORTA BARATTOLI SILVER DARK  
ARS HOLDER DARK SILVER



0865C0907S

PORTA BARATTOLI NERO  
ARS HOLDER BLACK



0865C0907N

**B**



## CANALE IN APPOGGIO - MODULO 1800

### LAY-ON BACK SECTION - MODULE 1800

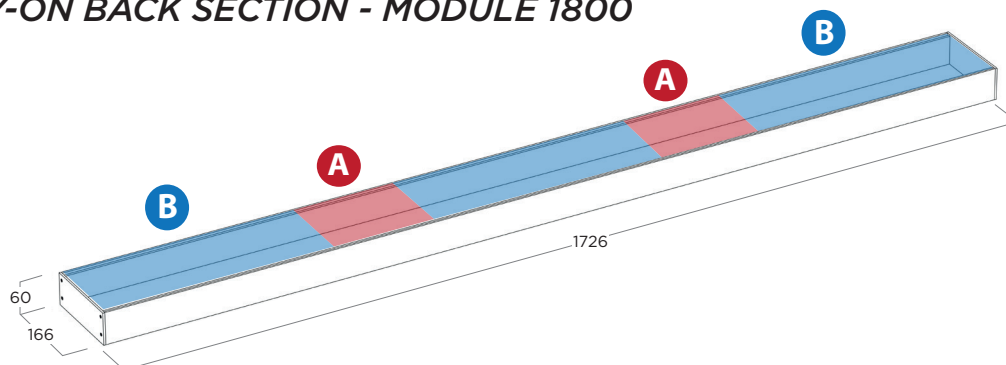

CODICE CODE	FINITURA FINISHING	MODULO (mm) MODULE (mm)	MISURE (mm) MEASURE (mm)
0865C0680G	Ghisa Cast Iron	1800	1726 x 166 x 60
0865C0680S	Silver Dark Dark Silver	1800	1726 x 166 x 60
0865C0680N	Nero Black	1800	1726 x 166 x 60

**A**

PORTA SPEZIE GHISA  
SPICE JARS HOLDER CAST IRON

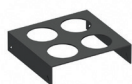

0865C0911G

VASSOIO GHISA  
U TRAY CAST IRON



0865C0910G

PORTA SPEZIE SILVER DARK  
SPICE JARS HOLDER DARK SILVER

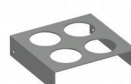

0865C0911S

VASSOIO SILVER DARK  
U TRAY DARK SILVER

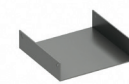

0865C0910S

PORTA SPEZIE NERO  
SPICE JARS HOLDER BLACK



0865C0911N

VASSOIO NERO  
U TRAY BLACK



0865C0910N

**B**

PORTA COLTELLI GHISA  
KNIVES RACK DARK CAST IRON

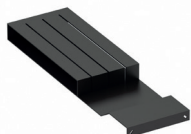

0865C0904G

PORTA OGGETTI GHISA  
OBJECT HOLDERS CAST IRON

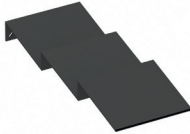

0865C0905G

PORTA SPEZIE GHISA  
SPICE JARS HOLDER CAST IRON



0865C0906G

PORTA BARATTOLI GHISA  
ARS HOLDER CAST IRON



0865C0907G

PORTA COLTELLI SILVER DARK  
KNIVES RACK DARK SILVER

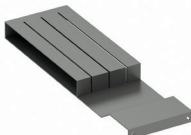

0865C0904S

PORTA OGGETTI SILVER DARK  
OBJECT HOLDERS DARK SILVER

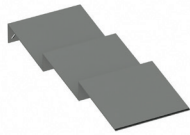

0865C0905S

PORTA SPEZIE SILVER DARK  
SPICE JARS HOLDER DARK SILVER



0865C0906S

PORTA BARATTOLI SILVER DARK  
ARS HOLDER DARK SILVER



0865C0907S

PORTA COLTELLI NERO  
KNIVES RACK BLACK

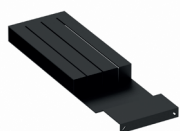

0865C0904N

PORTA OGGETTI NERO  
OBJECT HOLDERS BLACK

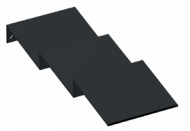

0865C0905N

PORTA SPEZIE NERO  
SPICE JARS HOLDER BLACK



0865C0906N

PORTA BARATTOLI NERO  
ARS HOLDER BLACK



0865C0907N

# ALZATA IN APPOGGIO

## *LAY-ON DOUBLE BACK SECTION*

---

2 Materiali | *Materials*

4 Canale a incasso | *Low depth back section*

16 Canale in appoggio | *Lay-on back section*

**24 Alzata in appoggio | *Lay-on double back section***

30 Finiture | *Finishings*



*L'alzata in appoggio non è altro che l'evoluzione del canale in appoggio sviluppato in altezza su due livelli di contenimento. Anche in questa situazione il fissaggio sul top avviene tramite lo speciale velcro che consente di poter rimuovere l'alzata in ogni momento, ma al contempo dona una stabilità perfetta quando fissata, senza necessità di lavorazioni sul top della cucina. Disponibile in tre lunghezze standard, si adatta perfettamente a tutti i tipi di cucina, sia nelle cucine a muro che nelle isole centro stanza. Equipaggiato con tutti gli accessori della linea BelNet 472, questo canale attrezzato è estremamente pratico e funzionale, portando carattere anche alle cucine più semplici.*

Evolution of the Lay-on Back Section, the Lay-On Double Back Section finds more storage space on the kitchen counter by expanding vertically. Using the reusable fastener to be kept in place, but moved when needed, the Lay-On Double brings dynamism to the cooking area. Coming in three standard measures, and three standard colors this back section can satisfy every cook's need for tidiness and functionality. Equipped with our BelNet 472 inserts, extremely versatile and practical the Lay-On Double Back Section is the perfect tool to accessorize the kitchen with order and style.

## ■ ALZATA IN APPOGGIO

### LAY-ON DOUBLE BACK SECTION

*Il fissaggio sul top avviene grazie ad uno speciale velcro che dà la possibilità di rimuoverlo ogni qualvolta ce ne sia il bisogno. Proprio questa caratteristica di fissaggio, che evita lavorazioni sul top della cucina, lo rende particolarmente semplice da installare anche su una cucina già esistente.*

Thanks to the reusable fastener at the bottom, the Lay-On Double Back Section stays where you put it, but can be moved when and where you need it, without requiring any milling on the kitchen top.

### FACILE DA INSTALLARE SUL TOP DELLA CUCINA

#### EASY TO INSTALL ON THE KITCHEN TOP

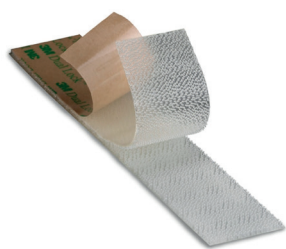

No Screws

No Holes

No Milled

### POSSIBILITÀ DI PERSONALIZZAZIONE

#### CUSTOMIZATION AVAILABLE

*L'alzata in appoggio può essere prodotta in misure personalizzate.*

The Lay-On Double Back Section can be produced in customized measures.

## ALZATA IN APPOGGIO - MODULO 900

### LAY-ON DOUBLE BACK SECTION - MODULE 900

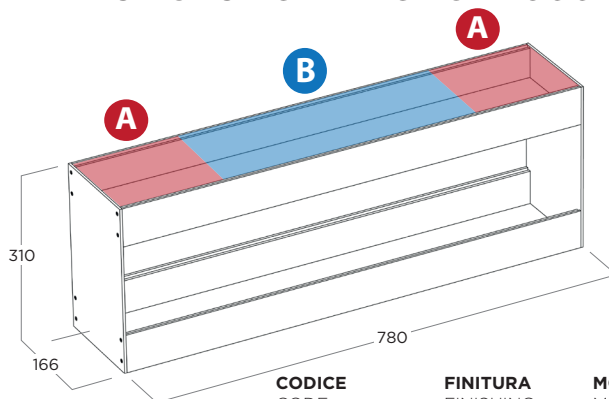

CODICE CODE	FINITURA FINISHING	MODULO (mm) MODULE (mm)	MISURE (mm) MEASURE (mm)
0865C0595G	Ghisa Cast Iron	900	780 x 166 x 310
0865C0595S	Silver Dark Dark Silver	900	780 x 166 x 310
0865C0595N	Nero Black	900	780 x 166 x 310

PORTA SPEZIE GHISA  
SPICE JARS HOLDER CAST IRON

VASSOIO GHISA  
U TRAY CAST IRON

PORTA SPEZIE SILVER DARK  
SPICE JARS HOLDER DARK SILVER

VASSOIO SILVER DARK  
U TRAY DARK SILVER

A

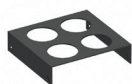

0865C0911G

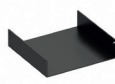

0865C0910G

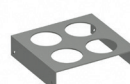

0865C0911S

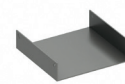

0865C0910S

PORTA SPEZIE NERO  
SPICE JARS HOLDER BLACK

VASSOIO NERO  
U TRAY BLACK



0865C0911N



0865C0910N

PORTA COLTELLI GHISA  
KNIVES RACK DARK CAST IRON

PORTA OGGETTI GHISA  
OBJECT HOLDERS CAST IRON

PORTA SPEZIE GHISA  
SPICE JARS HOLDER CAST IRON

PORTA BARATTOLI GHISA  
ARS HOLDER CAST IRON

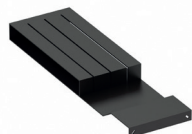

0865C0904G

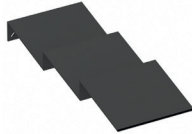

0865C0905G



0865C0906G



0865C0907G

PORTA COLTELLI SILVER DARK  
KNIVES RACK DARK SILVER

PORTA OGGETTI SILVER DARK  
OBJECT HOLDERS DARK SILVER

PORTA SPEZIE SILVER DARK  
SPICE JARS HOLDER DARK SILVER

PORTA BARATTOLI SILVER DARK  
ARS HOLDER DARK SILVER

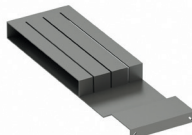

0865C0904S

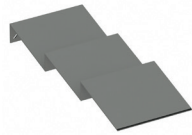

0865C0905S



0865C0906S



0865C0907S

PORTA COLTELLI NERO  
KNIVES RACK BLACK

PORTA OGGETTI NERO  
OBJECT HOLDERS BLACK

PORTA SPEZIE NERO  
SPICE JARS HOLDER BLACK

PORTA BARATTOLI NERO  
ARS HOLDER BLACK

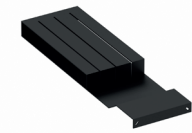

0865C0904N

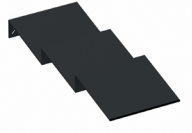

0865C0905N



0865C0906N



0865C0907N

B

## ALZATA IN APPOGGIO - MODULO 1200

### LAY-ON DOUBLE BACK SECTION - MODULE 1200

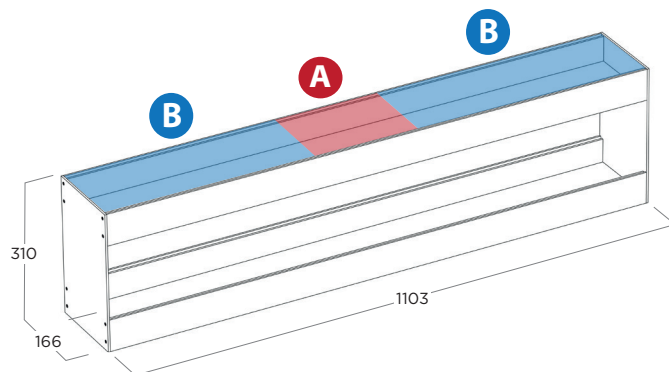

CODICE CODE	FINITURA FINISHING	MODULO (mm) MODULE (mm)	MISURE (mm) MEASURE (mm)
0865C0625G	Ghisa Cast Iron	1200	1103 x 166 x 310
0865C0625S	Silver Dark Dark Silver	1200	1103 x 166 x 310
0865C0625N	Nero Black	1200	1103 x 166 x 310

PORTA SPEZIE GHISA  
SPICE JARS HOLDER CAST IRON

VASSOIO GHISA  
U TRAY CAST IRON

PORTA SPEZIE SILVER DARK  
SPICE JARS HOLDER DARK SILVER

VASSOIO SILVER DARK  
U TRAY DARK SILVER

A

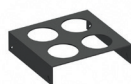

0865C0911G



0865C0910G

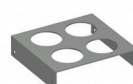

0865C0911S

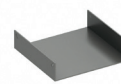

0865C0910S

PORTA SPEZIE NERO  
SPICE JARS HOLDER BLACK

VASSOIO NERO  
U TRAY BLACK



0865C0911N



0865C0910N

PORTA COLTELLI GHISA  
KNIVES RACK DARK CAST IRON

PORTA OGGETTI GHISA  
OBJECT HOLDERS CAST IRON

PORTA SPEZIE SILVER DARK  
SPICE JARS HOLDER DARK SILVER

PORTA BARATTOLI GHISA  
ARS HOLDER CAST IRON

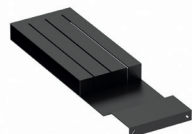

0865C0904G

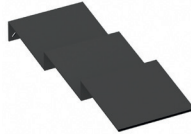

0865C0905G



0865C0906G



0865C0907G

PORTA COLTELLI SILVER DARK  
KNIVES RACK DARK SILVER

PORTA OGGETTI SILVER DARK  
OBJECT HOLDERS DARK SILVER

PORTA SPEZIE SILVER DARK  
SPICE JARS HOLDER DARK SILVER

PORTA BARATTOLI SILVER DARK  
ARS HOLDER DARK SILVER

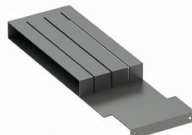

0865C0904S

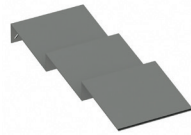

0865C0905S



0865C0906S

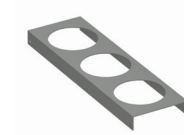

0865C0907S

PORTA COLTELLI NERO  
KNIVES RACK BLACK

PORTA OGGETTI NERO  
OBJECT HOLDERS BLACK

PORTA SPEZIE NERO  
SPICE JARS HOLDER BLACK

PORTA BARATTOLI NERO  
ARS HOLDER BLACK

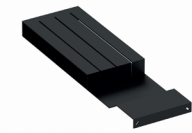

0865C0904N

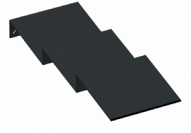

0865C0905N



0865C0906N



0865C0907N

B

## ALZATA IN APPOGGIO - MODULO 1500

### LAY-ON DOUBLE BACK SECTION - MODULE 1500

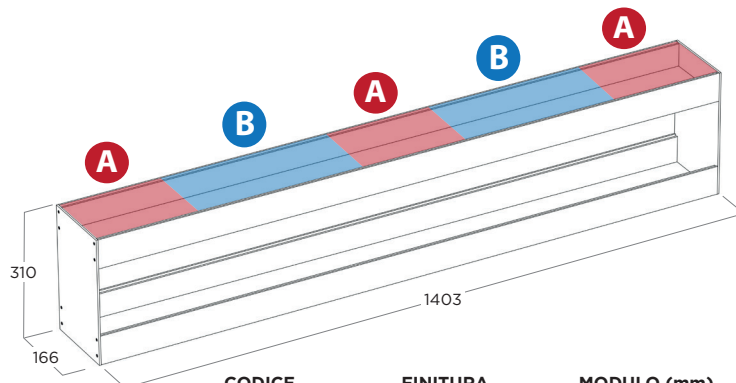

CODICE CODE	FINITURA FINISHING	MODULO (mm) MODULE (mm)	MISURE (mm) MEASURE (mm)
0865C0655G	Ghisa Cast Iron	1500	1403 x 166 x 310
0865C0655S	Silver Dark Dark Silver	1500	1403 x 166 x 310
0865C0655N	Nero Black	1500	1403 x 166 x 310

PORTA SPEZIE GHISA  
SPICE JARS HOLDER CAST IRON

VASSOIO GHISA  
U TRAY CAST IRON

PORTA SPEZIE SILVER DARK  
SPICE JARS HOLDER DARK SILVER

VASSOIO SILVER DARK  
U TRAY DARK SILVER

A

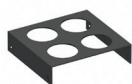

0865C0911G



0865C0910G

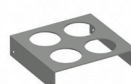

0865C0911S

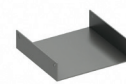

0865C0910S

PORTA SPEZIE NERO  
SPICE JARS HOLDER BLACK

VASSOIO NERO  
U TRAY BLACK



0865C0911N



0865C0910N

PORTA COLTELLI GHISA  
KNIVES RACK DARK CAST IRON

PORTA OGGETTI GHISA  
OBJECT HOLDERS CAST IRON

PORTA SPEZIE GHISA  
SPICE JARS HOLDER CAST IRON

PORTA BARATTOLI GHISA  
ARS HOLDER CAST IRON

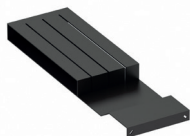

0865C0904G

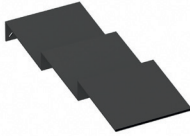

0865C0905G



0865C0906G



0865C0907G

PORTA COLTELLI SILVER DARK  
KNIVES RACK DARK SILVER

PORTA OGGETTI SILVER DARK  
OBJECT HOLDERS DARK SILVER

PORTA SPEZIE SILVER DARK  
SPICE JARS HOLDER DARK SILVER

PORTA BARATTOLI SILVER DARK  
ARS HOLDER DARK SILVER

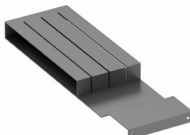

0865C0904S

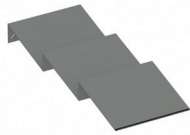

0865C0905S



0865C0906S



0865C0907S

PORTA COLTELLI NERO  
KNIVES RACK BLACK

PORTA OGGETTI NERO  
OBJECT HOLDERS BLACK

PORTA SPEZIE NERO  
SPICE JARS HOLDER BLACK

PORTA BARATTOLI NERO  
ARS HOLDER BLACK

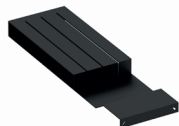

0865C0904N



0865C0905N



0865C0906N

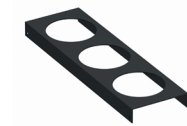

0865C0907N

B

# FINITURE

## *FINISHINGS*

---

2 Materiali | *Materials*

4 Canale a incasso | *Low depth back section*

16 Canale in appoggio | *Lay-on back section*

24 Alzata in appoggio | *Lay-on double back section*

**30 Finiture | *Finishings***



*\* Gli esempi di colore e materiale hanno valore indicativo.*

*\* The color and material references in this page are only indicative.*

## LEGNI IMPIALLACCIATI SU STRATIFICATO

*VENEERED WOOD ON COMPACT HPL*

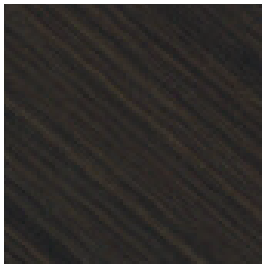

**OAK DARK BROWN**  
DARK BROWN OAK

## ALLUMINIO

*ALUMINIUM*



**SILVER DARK**  
DARK SILVER

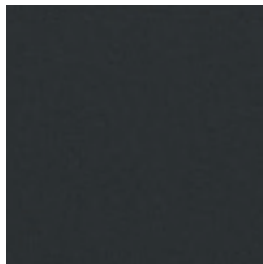

**GHISA**  
CAST IRON



**ALLUMINIO NERO**  
BLACK ALUMINIUM

GRUPPOLUBE



BOISERIE HI-LINE

2023

La **Boiserie Hi-line** è un rivestimento funzionale.

Un elemento che dona al tuo arredamento un grande impatto estetico e ti permette di attrezzare la parete, personalizzandola secondo le tue esigenze. I suoi elementi modulari permettono di avere a portata di mano tutto ciò che ti serve. Le mensole ed i vari accessori, danno anche la possibilità di tenere a vista elementi decorativi e di design, valorizzando la tua composizione anche dal punto di vista estetico.

La **Boiserie**, inoltre, può essere arricchita di luci led e prese elettriche, senza la necessità di dover per forza canalizzare la parete per l'impianto elettrico.

**Boiserie Hi-line** is a functional covering.

An element that allow to have a great aesthetic impact and also to equip the wall, customizing it according to your needs. Its modular elements are thought for having everything you need on hand. The shelves and accessories give the possibility to keep in sights decorative and design elements, enphatizing the furniture also from aesthetical point of view.

Furthermore, the **Boiserie** can be enriched with LED lights and electrical sockets, without modify the electrical system.







La **Boiserie Hi-line**, permette di personalizzare e trasformare non solo la zona cucina ma tutti gli ambienti della casa rendendo gli spazi più eleganti e funzionali. Questa soluzione può diventare una scelta valida anche negli interni dallo stile più contemporaneo.

The **Boiserie Hi Line** allows you to customize not only the kitchen area but also all house spaces, making them more elegant and functional. This solution maybe become a valid choice for contemporary style interiors.

---

# Categorie

## categories

---

### SOVRATOP OVERTOP



Soluzione inserita tra pensile e top.  
Possibilità di variante con luce LED  
nel profilo superiore.

Solution between kitchen cabinet  
and top. Its possible to choose the  
variant with LED light in the upper  
profile.

### ANGOLO CORNER



Modulo per soluzioni personalizzate  
adattabili anche nelle situazioni in  
cui sono presenti pareti con angolo.

Module for customized solutions,  
adaptable for situations with  
corner walls.

### PARETE WALL



Pannellature attrezzate da terra,  
pensate per trovare continuità con le  
modularità della cucina.

Panels equipped from the ground,  
designed to find continuity with the  
kitchen's modularity.



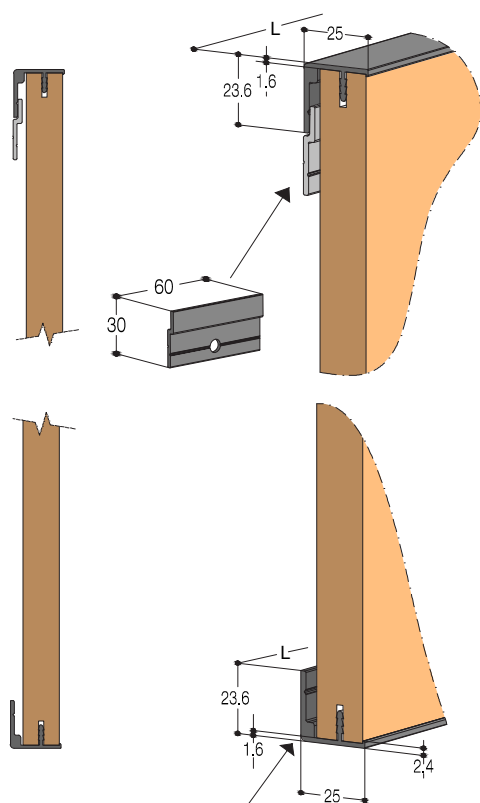

Profilo con fori asolati per fissaggio a parete  
Profile with slotted holes for wall fixing

### PROFILO CHIUSURA SUPERIORE/INFERIORE TOP/BOTTOM CLOSING PROFILE

Lunghezza max di taglio 3000 mm  
Max cutting length 3000 mm

FINITURA Finish	A/V*	CODICE Code
■ Nero black	A	086BHL01AL11
■ Titanio titanium	A	086BHL01AL12

- Profilo di chiusura superiore - compresi N.2 piastrini per aggancio a muro ogni 50 cm;
- Top closing profile - including 2 wall attachment plates every 50 cm;

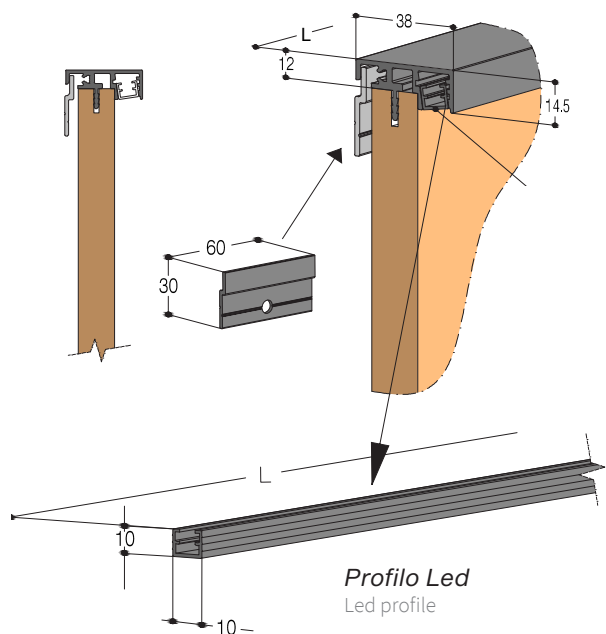

Profilo Led  
Led profile

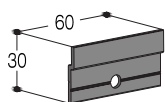

Kit piastrini fissaggio a parete  
inclusi con il profilo Boiserie  
(n.2 piastrini Mtl.)  
Wall fixing plate kit  
included with the Boiserie profile  
(n.2 plates Mtl.)

### PROFILO CHIUSURA SUPERIORE CON LED UPPER CLOSING PROFILE WITH LED

Lunghezza max di taglio 3000 mm  
Max cutting length 3000 mm

FINITURA Finish	A/V*	CODICE Code
■ Nero black	A	086BHL06AL11
■ Titanio titanium	A	086BHL06AL12

- Profilo superiore e barra LED - Dual Color 3000/4000k compreso - NON INSTALLATA; assorbimento 11,4 Watt/M
- Upper profile and LED bar - Dual Color 3000/4000k included - but NOT INSTALLED; absorption 11.4 Watt/M

\*A/V: A=ANODIZZATO V=VERNICIATO  
ANODIZED PAINTED



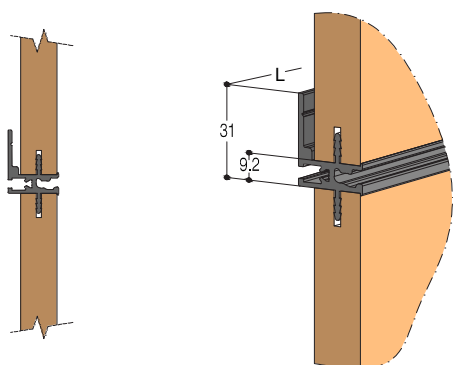

**PROFILO INTERMEDIO PER PANNELLI LEGNO**  
**INTERMEDIATE PROFILE FOR WOOD PANELS**

Lunghezza max di taglio 3000 mm  
Max cutting length 3000 mm

FINITURA Finish	A/V*	CODICE Code
■ Nero black	A	086BHL03AL11
■ Titanio titanium	A	086BHL03AL12

- Profilo intermedio CON SPINA SOPRA/SOTTO;
- Intermediate profile WITH PLUG ABOVE/BELOW,

*Profilo con fori asolati per fissaggio a parete*  
Profile with slotted holes for wall fixing

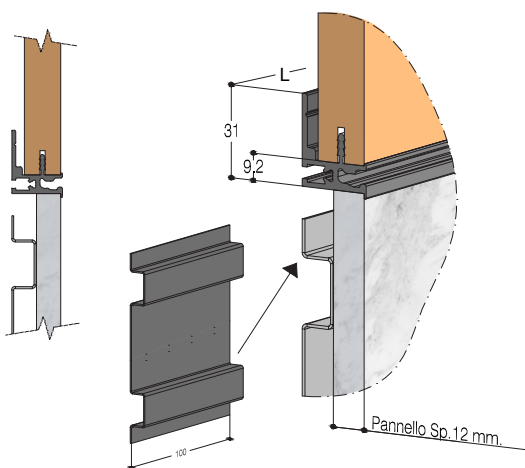

**PROFILO INTERMEDIO PER PANNELLI IN COMPOSITO**  
**INTERMEDIATE PROFILE FOR COMPOSITE PANELS**

Lunghezza max di taglio 3000 mm  
Max cutting length 3000 mm

FINITURA Finish	A/V*	CODICE Code
■ Nero black	A	086BHL04AL11
■ Titanio titanium	A	086BHL04AL12

- Profilo intermedio CON SPINA SOPRA- SENZA SPINA SOTTO;
- Intermediate profile WITH PLUG ABOVE - WITHOUT PLUG BELOW;

*Profilo con fori asolati per fissaggio a parete*  
Profile with slotted holes for wall fixing

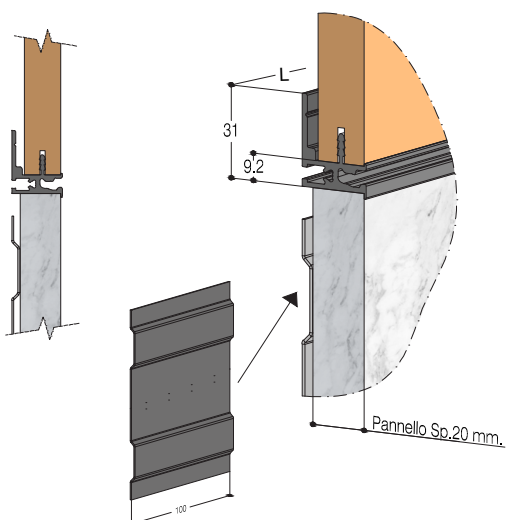

**N.B.: Solo per boiserie sopratop**  
**Note: Only for boiserie worktop**

\*A/V: A=ANODIZZATO V=VERNICIATO  
ANODIZED PAINTED

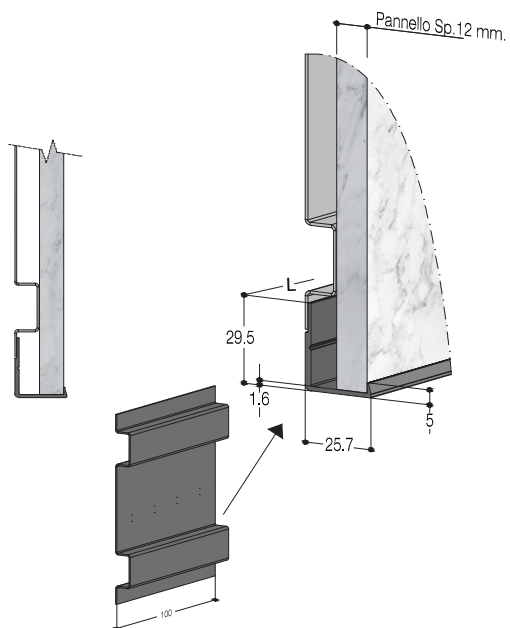

**PROFILO CHIUSURA INF. PER MATERIALI COMPOSITI**  
**BOTTOM CLOSING PROFILE FOR COMPOSITE MATERIALS**

Lunghezza max di taglio 3200 mm  
Max cutting length 3200 mm

FINITURA Finish	A/V*	CODICE Code
■ Nero black	A	086BHL02AL11
■ Titanio titanium	A	086BHL02AL12

- Profilo inferiore SENZA SPINA;
- Bottom profile WITHOUT PLUG

**N.B.: Solo per boiserie sopratop**  
**Note: Only for boiserie worktop**

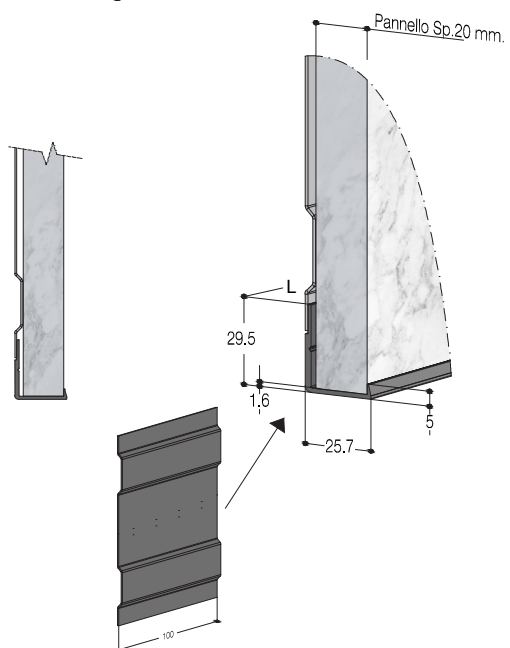

## Lamiere compensazione Compensating sheets

**N.B.: per pannello sp.20**

Note: for panel th.20

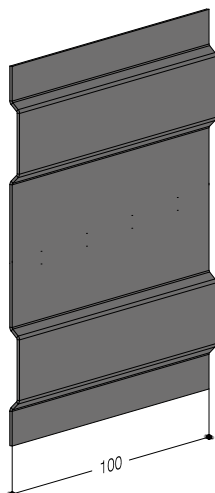

### COPPIA DI COMPENSATORI PER PANNELLI SP.12-20 MM PAIR OF COMPENSATORS FOR PANELS THICKNESS 12-20 MM

FINITURA Finish	A/V'	CODICE Code
■ Grezzo raw	A	086BHL11

**N.B.: Considerare una coppia di compensatori ogni metro di  
composizione**

Note: Consider a pair of compensators for every meter of composition

**N.B.: per pannello sp.12**

Note: for panel th.12

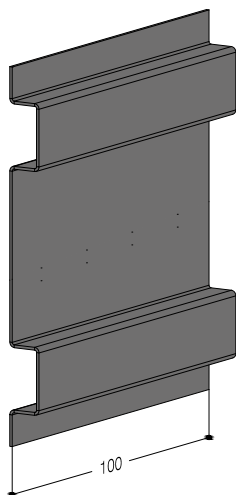

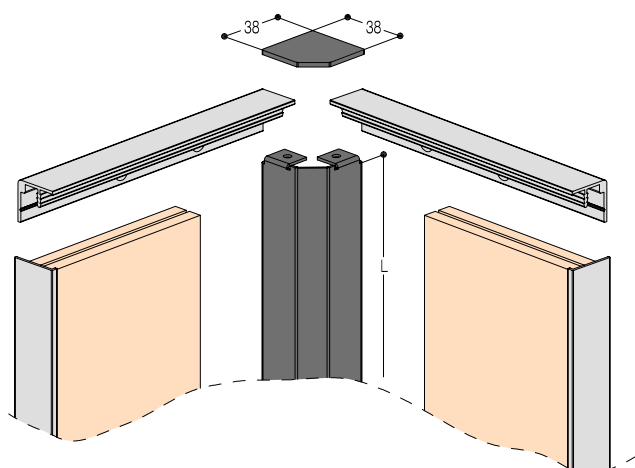

**PROFILO ANGOLARE C/PIASTRINO DI CHIUSURA**  
**ANGULAR PROFILE WITH CLOSING COVER**

Dimensioni piastrino L.38xP.38 mm  
Cover dimension L.38xP.38 mm.

FINITURA Finish	A/V*	CODICE Code
■ Nero black	A	086BHL08AL11
■ Titanio titanium	A	086BHL08AL12

- Profilo angolo con piastrino di chiusura;
- Corner profile with closing plate;

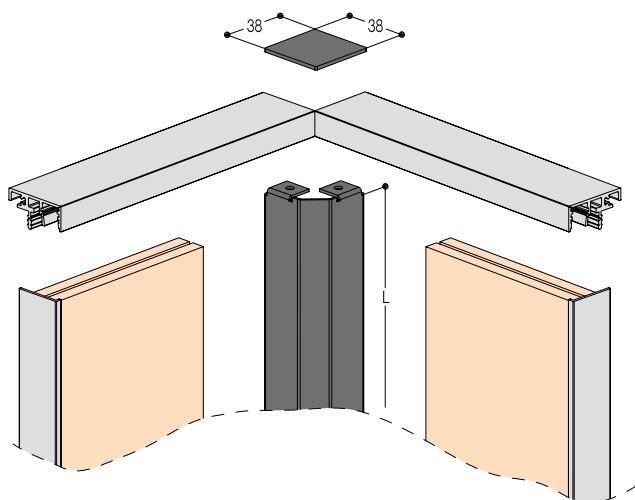

**PROFILO ANGOLARE C/PIASTRINO DI CHIUSURA PER LED**  
**ANGULAR PROFILE WITH CLOSING COVER FOR LED**

Dimensioni piastrino L.38xP.38 mm  
Cover dimension L.38xP.38 mm.

FINITURA Finish	A/V*	CODICE Code
■ Nero black	A	086BHL09AL11
■ Titanio titanium	A	086BHL09AL12

- Profilo angolo con piastrino di chiusura;
- Corner profile with closing plate;

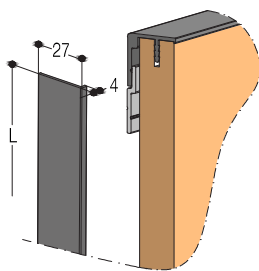

**PROFILO INTERMEDIO DI CHIUSURA VERTICALE**  
**VERTICAL INTERMEDIATE CLOSING PROFILE**

FINITURA Finish	A/V'	CODICE Code
■ Nero black	A	086BHL07AL11
■ Titanio titanium	A	086BHL07AL12

**N.B.: Se si supera la lunghezza massima dei pannelli e si vogliono accostare piu' moduli per allungare la composizione tra questi vanno sempre inseriti i profili intermedi in accosto.**

**Note: If you exceed the maximum length of the panels and you want to combine several modules to lengthen the composition between them the intermediate profiles must always be inserted side by side.**

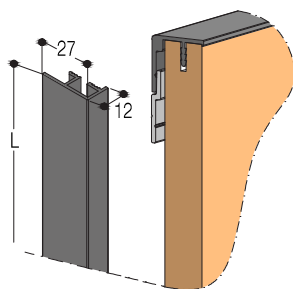

**PROFILO DI CHIUSURA LATERALE L 12**  
**LATERAL CLOSING W 12 PROFILE**

FINITURA Finish	A/V'	CODICE Code
■ Nero black	A	086BHL12AL11
■ Titanio titanium	A	086BHL12AL12

**N.B.: Profilo laterale obbligatorio ad inizio/fine composizione**

**Note: Mandatory side profile at the start/end of the composition**

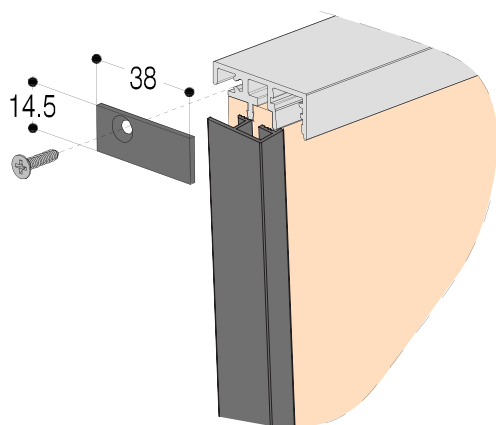

**COPPIA TAPPI CHIUSURA (DX/SX) PER BARRA BOISERIE C/LED**  
**CAPS PAIR OF CLOSURES (R/L) FOR WOODEN BAR W/LED**

FINITURA Finish	A/V'	CODICE Code
■ Nero black	A	086BHL10AL11
■ Titanio titanium	A	086BHL10AL12



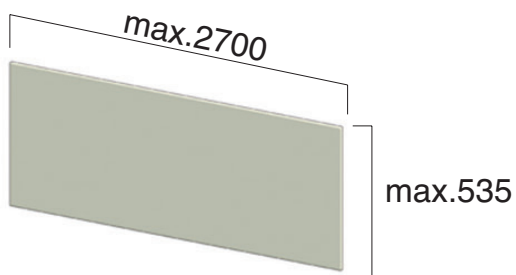

**PANNELLO CON FRESATA SUPERIORE E INFERIORE**  
( Utilizzabile su tutte le tipologie di Boiserie)  
**PANEL WITH UPPER AND LOWER MILLING**  
(Can be used on all types of Boiserie)

**TIPOLOGIA**

Type

Melaminico melamine Tablet  
Melaminico melamine Immagina  
Melaminico melamine Unica  
Laminato come top laminate same as worktop  
Laccato UV UV lacquered  
Fenix

**CODICE**

Code

086BHP01  
086BHP01  
086BHP01  
086BHP01  
086BHP01  
086BHP01

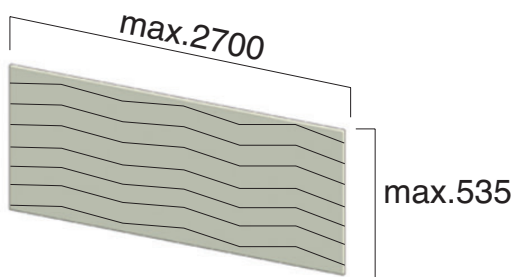

**PANNELLO CON FRESATA SUP. E INF. VENATURA VERTICALE**  
( Utilizzabile su tutte le tipologie di Boiserie)  
**PANEL WITH UPPER AND LOWER MILLED VERTICAL GRAIN**  
(Can be used on all types of Boiserie)

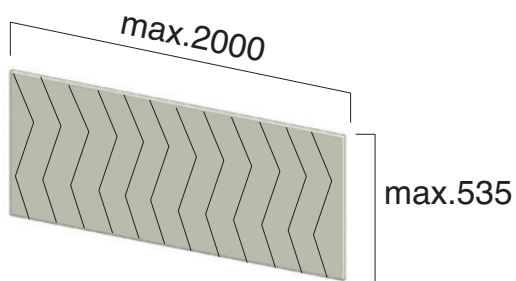

**TIPOLOGIA**

Type

Melaminico melamine Tablet  
Melaminico melamine Immagina  
Melaminico melamine Unica

**CODICE**

Code

086BHP03  
086BHP03  
086BHP03

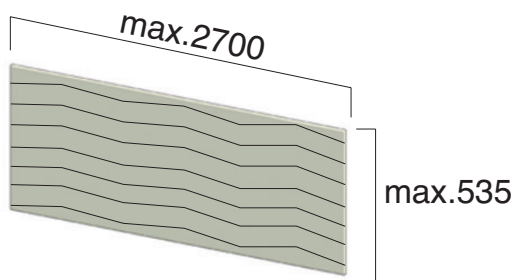

**PANNELLO CON FRESATA SUP. E INF. IMPIALLACCIATO VENATURA ORIZZONTALE**  
( Utilizzabile su tutte le tipologie di Boiserie)  
**PANEL WITH MILLING UPPER AND LOWER HORIZONTAL GRAIN VENEERED**  
(Can be used on all types of Boiserie)

TIPOLOGIA Type	CODICE Code	FASCIA A Category A	FASCIA B Category B	FASCIA C Category C
Wood	086BHP04			
Impiallacciato veneered Clover	086BHP04			
Impiallacciato veneered Flavour	086BHP04			
Impiallacciato veneered Luna	086BHP04			
Impiallacciato veneered Oltre	086BHP04			

**N.B.: Costi riferiti al MQ**  
Note: Cost referred per squadre meter

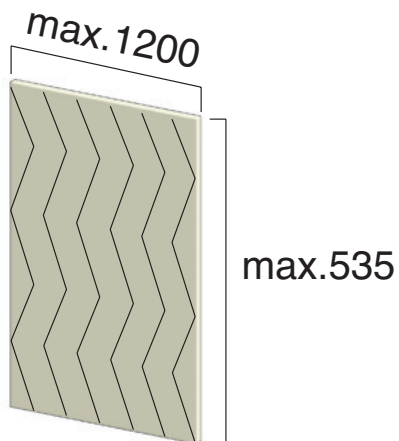

**PANNELLO CON FRESATA SUP. E INF. IMPIALLACCIATO VENATURA VERTICALE**  
( Utilizzabile su tutte le tipologie di Boiserie)  
**PANEL WITH UPPER AND LOWER MILLED VEENERED VERTICAL GRAIN**  
(Can be used on all types of Boiserie)

TIPOLOGIA Type	CODICE Code	FASCIA A Category A	FASCIA B Category B	FASCIA C Category C
Wood	086BHP05			
Impiallacciato veneered Clover	086BHP05			
Impiallacciato veneered Flavour	086BHP05			
Impiallacciato veneered Luna	086BHP05			
Impiallacciato veneered Oltre	086BHP05			

**N.B.: Costi riferiti al MQ**  
Note: Cost referred per squadre meter



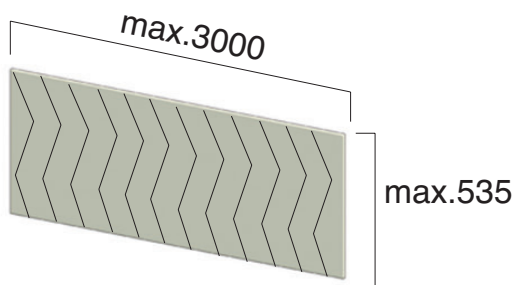

**PANNELLO CON FRESATA SUPERIORE E INFERIORE**  
( Utilizzabile su tutte le tipologie di Boiserie)  
**PANEL WITH UPPER AND LOWER MILLED VERTICAL GRAIN**  
(Can be used on all types of Boiserie)

**TIPOLOGIA**  
Type  
Mathera

**CODICE**  
Code  
086BHP07

**N.B.: solo per finiture selce**  
Note: only for flint finishes

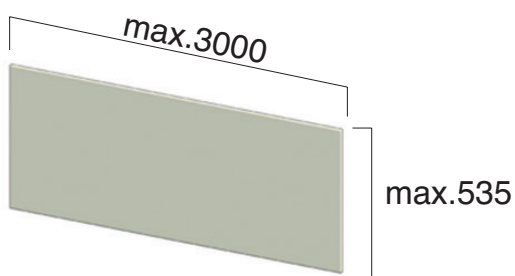

**PANNELLO CON FRESATA SUP. E INF. VENATURA ORIZZONTALE**  
( Utilizzabile su tutte le tipologie di Boiserie)  
**PANEL WITH UPPER AND LOWER MILLED HORIZONTAL GRAIN**  
(Can be used on all types of Boiserie)

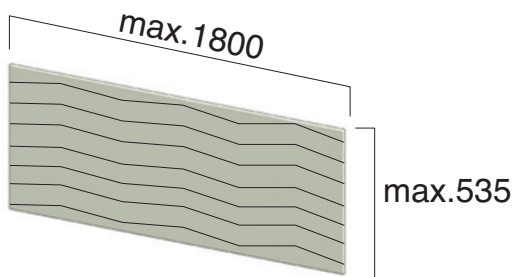

**TIPOLOGIA**  
Type  
Mathera

**CODICE**  
Code  
086BHP06

**N.B.: solo per finiture selce**  
Note: only for flint finishes

## Pannelli Panels

**Durante la fase di progettazione bisogna tener presente sia del limite dimensionale del pannello (altezza e larghezza max.) che in caso di finiture materiche, dell'orientamento della venatura.**

**During the design phase, it is necessary to keep in mind both the panel dimensional limit (height and width max.) and in the case of finishes material, the grain orientation (vertical or horizontal).**

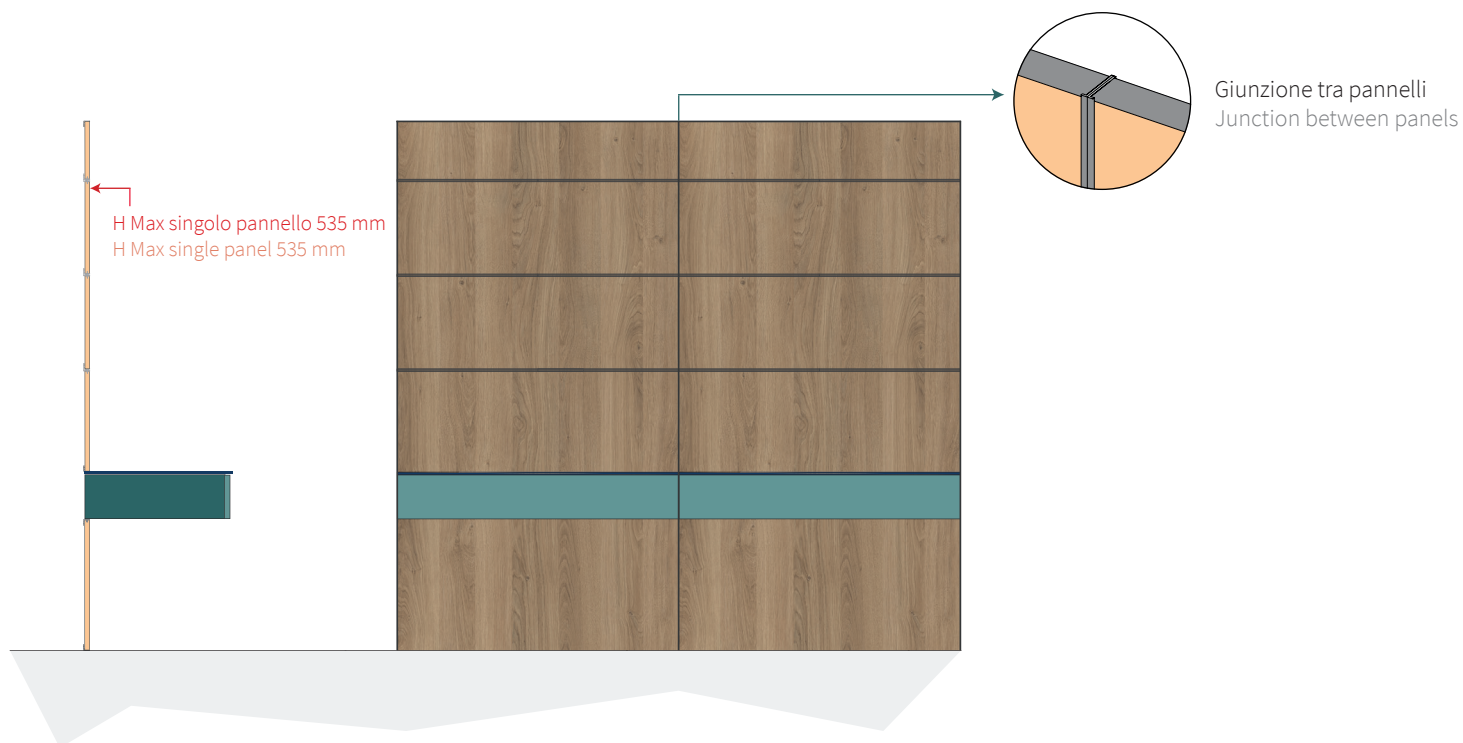

---

**Pannelli in composito solo elemento inferiore per composizione sopratop**  
**Composite panels only lower element for lay on worktop composition**

---

**N.B.: Solo per la tipologia di composizione tra base e top e' possibile inserire il pannello inferiore in composito nelle tipologie riportate di seguito.**

**Note: Only for the type of composition between base unit and worktop it is possible to insert the composite lower panel in the types listed below.**

KERLITE	TKRS12
KOROS	TKSS12
GRES LAMINAM	TLNS12
INFINITY	TINS12
DEKTON	TDES20
OKITE	094022
QUARZI	TQRS20
SILESTONE	TSIS20
STRATIFICATO HPL	THPLS13

---

# Finiture Pannelli

## Panels finishes

---

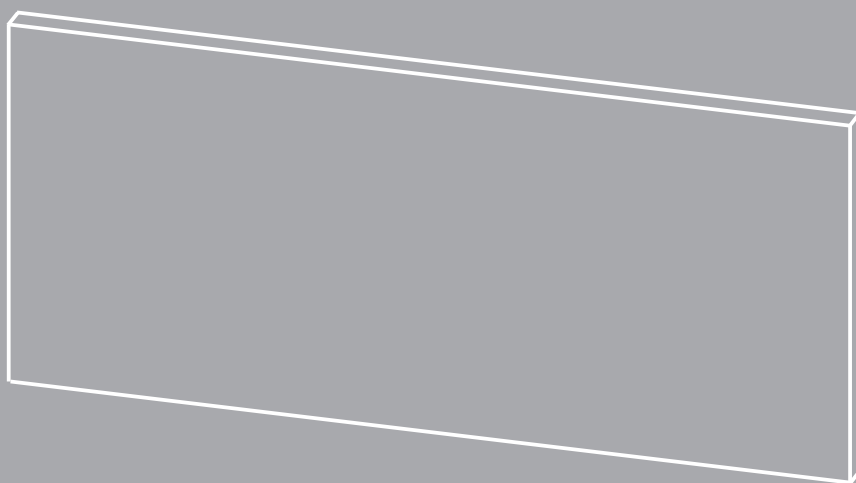

**\*COLORI IMPIALLACCIATI MODELLO OLTRE FASCIA A**  
**OLTRE MODEL VENEERED COLOURS CATEGORY A**



**\*COLORI IMPIALLACCIATI MODELLO CLOVER FASCIA A**  
**CLOVER MODEL VENEERED COLOURS CATEGORY A**



**\*COLORI IMPIALLACCIATI MODELLO CLOVER FASCIA B**  
**CLOVER MODEL VENEERED COLOURS CATEGORY B**

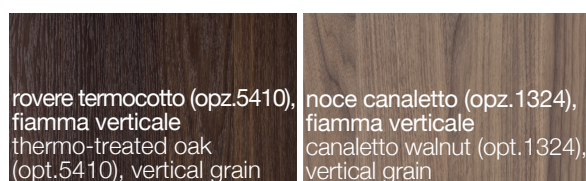

**\* N.B.: Possibilita' di venatura sia verticale che orizzontale, per i codici vedi pag.17**  
**Note: Possibility of both vertical and horizontal grain, for codes see page 17**

**COLORI IMPIALLACCIATI MODELLO LUNA FASCIA A**  
LUNA MODEL VENEERED COLOURS **CATEGORY A**

 <p>rovere bianco (opz.5429), fiamma orizzontale white oak (opt.5429), horizontal grain</p>	 <p>rovere grigio reale (opz.5432), fiamma orizzontale royal grey oak (opt.5432), horizontal grain</p>	 <p>rovere grigio traffico (opz.5431), fiamma orizzontale traffic grey oak (opt.5431), horizontal grain</p>	 <p>rovere carbon (opz.5434) fiamma orizzontale carbon oak (opt.5434), horizontal grain</p>
 <p>rovere natur (opz.5440) fiamma orizzontale natur oak (opt.5440), horizontal grain</p>	 <p>rovere lino (opz.5430) fiamma orizzontale linen oak (opt.5430), horizontal grain</p>	 <p>rovere moresco (opz.5433) fiamma orizzontale moresco oak (opt.5433), horizontal grain</p>	

**COLORI IMPIALLACCIATI MODELLO LUNA FASCIA B**  
LUNA MODEL VENEERED COLOURS **CATEGORY B**

 <p>noce canaletto (opz.1331) fiamma orizzontale canaletto walnut (opt.1331), horizontal grain</p>
--

**\*COLORI IMPIALLACCIATI MODELLO IMMAGINA WOOD FASCIA B**  
IMMAGINA WOOD MODEL VENEERED COLOURS **CATEGORY B**

 <p>rovere naturale (opz.5442), fiamma verticale natural oak (opt.5442), vertical grain</p>	 <p>rovere grey (opz.5443), fiamma verticale grey oak (opt.5443), vertical grain</p>	 <p>rovere moscato (opz.5444), fiamma verticale muscat oak (opt.5444), vertical grain</p>	 <p>rovere fumè (opz.5445), fiamma verticale smoked oak (opt.5445), vertical grain</p>
 <p>rovere bianco (opz.5441), fiamma verticale white oak (opt.5441), vertical grain</p>	 <p>rovere nero (opz.5446), fiamma verticale black oak (opt.5446), vertical grain</p>		

**\* N.B.: Possibilita' di venatura sia verticale che orizzontale, per i codici vedi pag.17**  
**Note: Possibility of both vertical and horizontal grain, for codes see page 17**

## Finiture Pannelli

### Panels finishes

#### \*COLORI IMPIALLACCIATI MODELLO FLAVOUR FASCIA A

##### FLAVOUR MODEL VENEERED COLOURS CATEGORY A



#### \*COLORI IMPIALLACCIATI MODELLO FLAVOUR FASCIA B

##### FLAVOUR MODEL VENEERED COLOURS CATEGORY B



#### COLORI IMPIALLACCIATI MODELLO CLOVER FASCIA C

##### CLOVER MODEL VENEERED COLOURS CATEGORY C

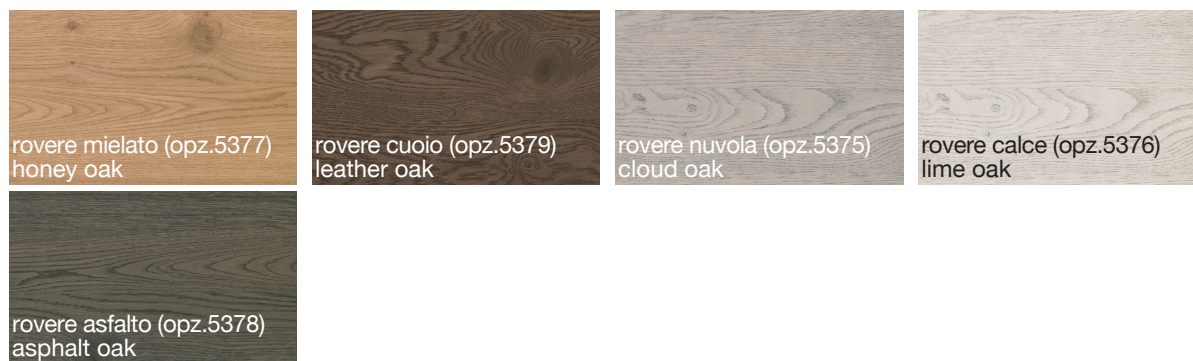

#### COLORI MODELLO IMMAGINA MATHERA FINTURA AREIA

##### IMMAGINA MATHERA MODEL COLOURS AREIA FINISH

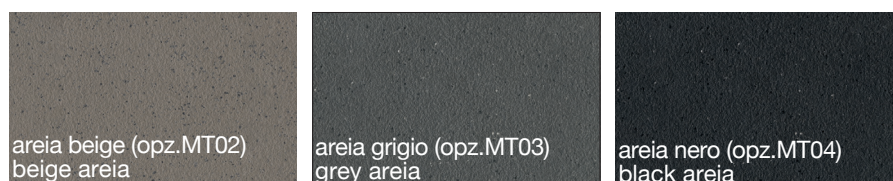

#### COLORI MODELLO IMMAGINA MATHERA FINTURA GIPSO

##### IMMAGINA MATHERA MODEL COLOURS GIPSO FINISH

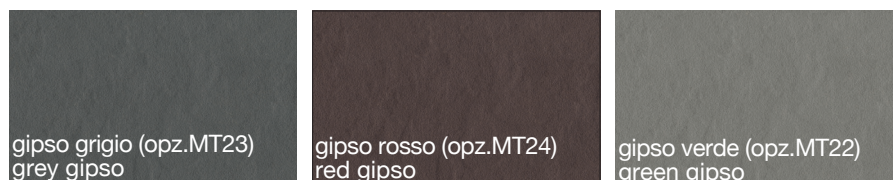

#### \*COLORI MODELLO IMMAGINA MATHERA FINTURA SELCE VENATURE VERTICALI

##### IMMAGINA MATHERA MODEL COLOURS SELCE FINISH WITH VERTICAL GRAIN

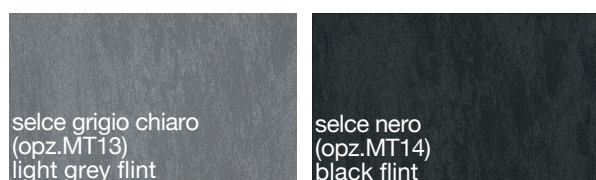

\* **N.B.:** Possibilita' di venatura sia verticale che orizzontale, per i codici vedi pag.17-18





Note: Possibility of both vertical and horizontal grain, for codes see page 17-18

## Finiture Pannelli

### Panels finishes

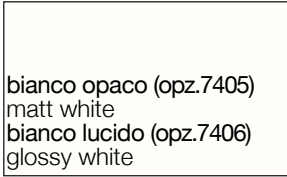
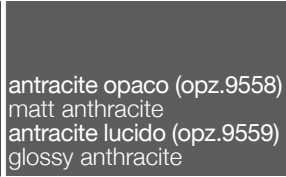
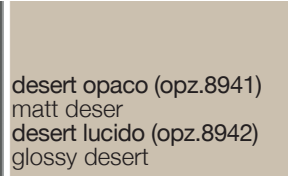
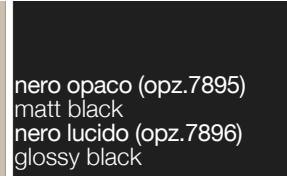
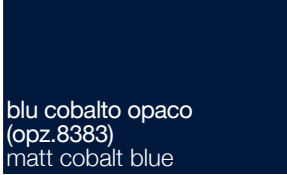
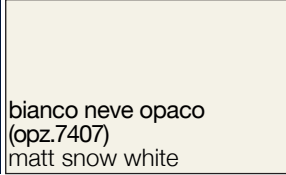
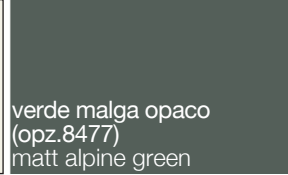
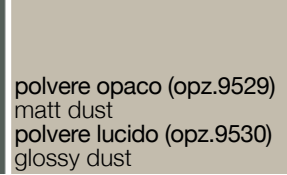

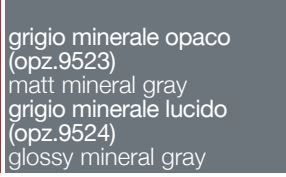
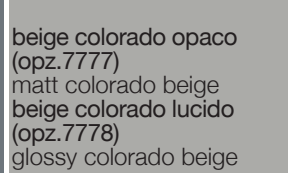
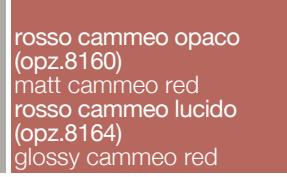

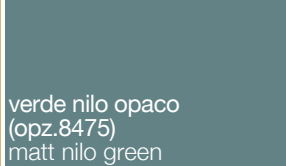

## COLORI LACCATI UV

### UV LACQUERED COLOURS

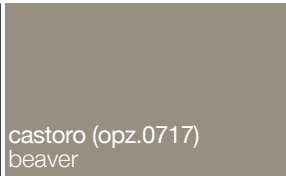
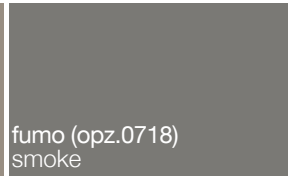
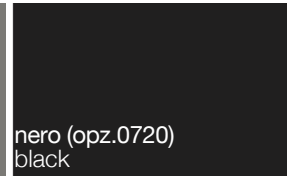
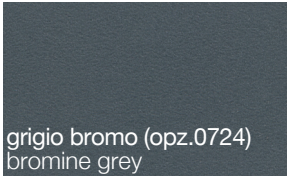
 <p>bianco opaco (opz.7405) matt white bianco lucido (opz.7406) glossy white</p>	 <p>antracite opaco (opz.9558) matt anthracite antracite lucido (opz.9559) glossy anthracite</p>	 <p>desert opaco (opz.8941) matt deser desert lucido (opz.8942) glossy desert</p>	 <p>nero opaco (opz.7895) matt black nero lucido (opz.7896) glossy black</p>
 <p>blu cobalto opaco (opz.8383) matt cobalt blue</p>	 <p>bianco neve opaco (opz.7407) matt snow white</p>	 <p>verde malga opaco (opz.8477) matt alpine green</p>	 <p>polvere opaco (opz.9529) matt dust polvere lucido (opz.9530) glossy dust</p>
 <p>rosso velvet opaco (opz.8168) matt velvet red</p>	 <p>grigio minerale opaco (opz.9523) matt mineral gray grigio minerale lucido (opz.9524) glossy mineral gray</p>	 <p>beige colorado opaco (opz.7777) matt colorado beige beige colorado lucido (opz.7778) glossy colorado beige</p>	 <p>rosso cammeo opaco (opz.8160) matt cammeo red rosso cammeo lucido (opz.8164) glossy cammeo red</p>
 <p>giallo cadmio opaco (opz.8255) matt cadmio yellow</p>	 <p>verde nilo opaco (opz.8475) matt nilo green</p>		

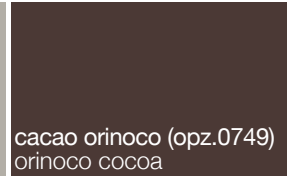
## COLORI FENIX

### FENIX COLOURS

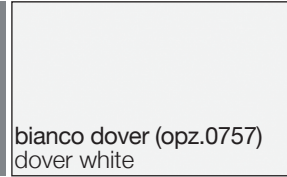
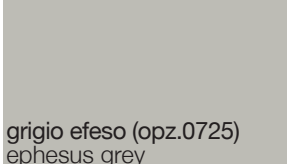
 <p>bianco caldo (opz.0032) warm white</p>	 <p>castoro (opz.0717) beaver</p>	 <p>fumo (opz.0718) smoke</p>	 <p>nero (opz.0720) black</p>
 <p>grigio bromo (opz.0724) bromine grey</p>	 <p>bronzo doha (opz.2629) doha bronze</p>	 <p>beige arizona (opz.0748) arizona beige</p>	 <p>cacao orinoco (opz.0749) orinoco cocoa</p>
 <p>verde commodoro (opz.0750) commodoro green</p>	 <p>rosso jaipur (opz.0751) jaipur red</p>	 <p>grigio antrim (opz.0752) antrim grey</p>	 <p>bianco dover (opz.0757) dover white</p>
 <p>grigio efeso (opz.0725) ephesus grey</p>			



## Finiture Pannelli

### Panels finishes

## COLORI MELAMINICI

### MELAMINE COLOURS







cansiglio terra bruciata (opz.1562), venatura verticale cansiglio scorched earth (opt.1562), vertical grain	pagos nuvola (opz.1567) phagos cloud	pagos bianco (opz.1566) phagos white	rovere perla (opz.5314) oak pearl
pagos kapok (opz.1560) phagos kapok	pagos vulcano (opz.1568) phagos volcano	salix brown (opz.1521) brown salix	abies moka (opz.4410) moka abies
abies bistro (opz.4411) bistro abies	rovere grigio chiaro (opz.5328) light oak gray	rovere grafite (opz.5327) graphite oak	rovere chiaro (opz.5325) light oak
rovere duna (opz.5326) dune oak	castagno bianco (opz.3055) white chestnut	rovere luna (opz.5316) moon oak	rovere venere (opz.5315) venus oak
rovere arizona (opz.5317) arizona oak	rovere dark (opz.5318) dark oak	frassino lava (opz.2408) lava ash	frassino sabbia (opz.2406) sand ash
frassino pietra (opz.2407) stone ash	noce brown (opz.2371) brown walnut	rovere tabià (opz.5309) tabià oak	rovere ortisei (opz.5305) ortisei oak
peltro (opz.9666) pewter	ottone chiaro (opz.7707) light brass	rame brunito (opz.8868) burnished copper	rigatino verticale arena (opz.9647V) arena vertical reed effect
rigatino orizzontale arena (opz.9647O) arena horizontal reed effect	rigatino verticale laguna (opz.9648V) lagoon vertical reed effect	rigatino orizzontale laguna (opz.9648O) lagoon horizontal reed effect	verde marino (opz.8402N) sea green
nichel (opz.9660) nickel	platino (opz.9661) platinum	oxide (opz.8871) oxide	pietra grey (opz.9642) stone grey
bianco assoluto (opz.7450) absolute white	ecru (opz.9641) ecru	antracite (opz.9643) anthracite	dove grey (opz.8971) grey dove

## Finiture Pannelli

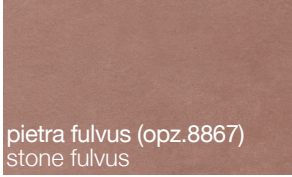
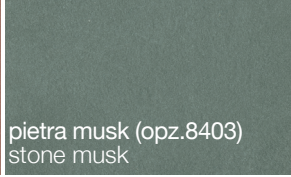
### Panels finishes

## COLORI MELAMINICI

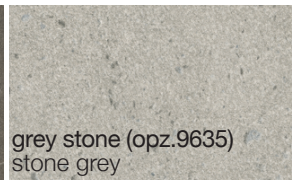
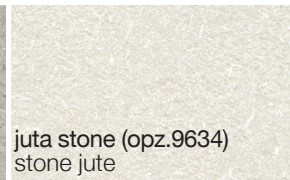
### MELAMINE COLOURS

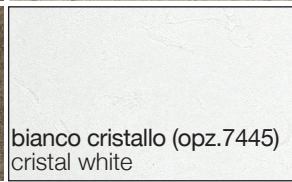
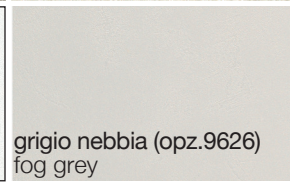
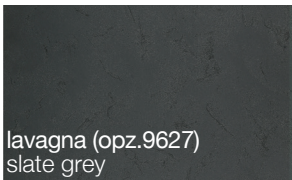
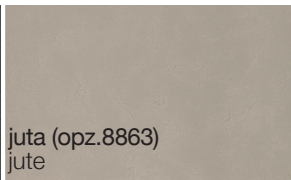
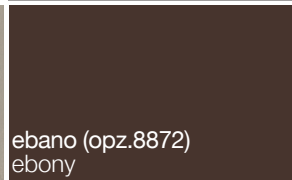
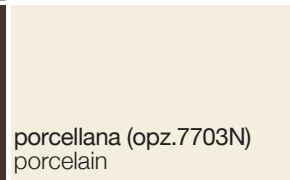
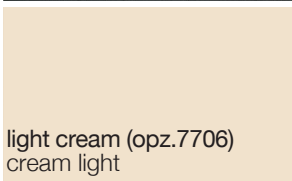
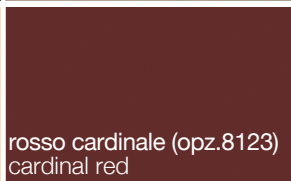
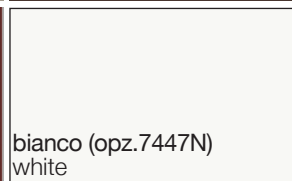
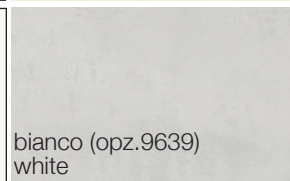
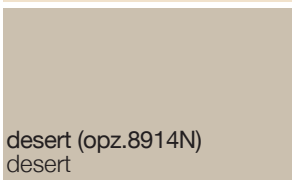
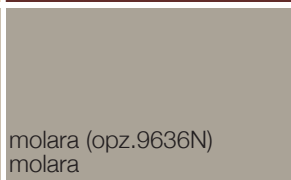
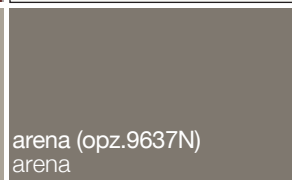
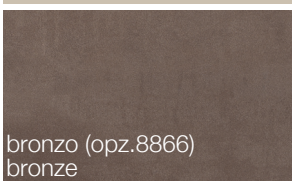
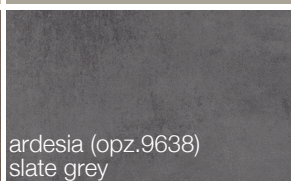
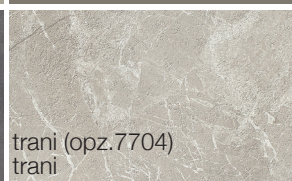
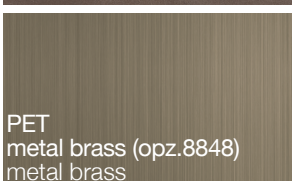
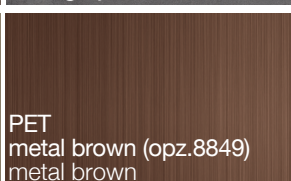
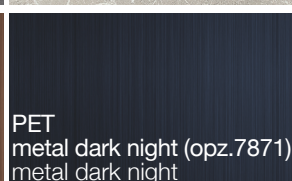
 <p>pietra fulvus (opz.8867) stone fulvus</p>	 <p>pietra musk (opz.8403) stone musk</p>	 <p>grigio chiaro (opz.9640) clear grey</p>	 <p>salix grey (opz.1522) grey salix</p>
 <p>marmo white yule (opz.9645) yule white marble</p>	 <p>marmo venato grigio (opz.8870) grey veined marble</p>	 <p>grey stone (opz.9635) stone grey</p>	 <p>juta stone (opz.9634) stone jute</p>
 <p>bronze stone (opz.8869) stone bronze</p>	 <p>kea (opz.9646) kea</p>	 <p>bianco cristallo (opz.7445) cristal white</p>	 <p>grigio nebbia (opz.9626) fog grey</p>
 <p>lavagna (opz.9627) slate grey</p>	 <p>juta (opz.8863) jute</p>	 <p>ebano (opz.8872) ebony</p>	 <p>porcellana (opz.7703N) porcelain</p>
 <p>light cream (opz.7706) cream light</p>	 <p>rosso cardinale (opz.8123) cardinal red</p>	 <p>bianco (opz.7447N) white</p>	 <p>bianco (opz.9639) white</p>
 <p>desert (opz.8914N) desert</p>	 <p>molara (opz.9636N) molara</p>	 <p>arena (opz.9637N) arena</p>	
 <p>bronzo (opz.8866) bronze</p>	 <p>ardesia (opz.9638) slate grey</p>	 <p>trani (opz.7704) trani</p>	
 <p>PET metal brass (opz.8848) metal brass</p>	 <p>PET metal brown (opz.8849) metal brown</p>	 <p>PET metal dark night (opz.7871) metal dark night</p>	

COLORI LAMINATO COME TOP  
LAMINATE COLOURS AS WORKTOP

 <p>alabastro finitura mn (opz.6014) alabaster with mn finish</p>	 <p>dark finitura mn (opz.6133) dark with mn finish</p>	 <p>calacatta finitura mn (opz.6019) calacatta with mn finish</p>	 <p>bianco lasa finitura mn (opz.6152) lasa white with mn finish</p>
 <p>grigio cemento finitura touch (opz.786) cement grey touch finish</p>	 <p>bianco alpino finitura touch (opz.309C) alpine-white with touch finish</p>	 <p>peltro finitura ossidata (opz.L934) pewter with oxidized finish</p>	 <p>ferro finitura ossidata (opz.L933) iron with oxidized finish</p>
 <p>imperial black finitura ker (opz.3452) black imperial with ker finish</p>	 <p>bianco zara finitura ker (opz.3451) zara white with ker finish</p>	 <p>bianco finitura velvet (opz.800) white with velvet finish</p>	 <p>stone white finitura real (opz.SH09) white stone with real finish</p>
 <p>old grey finitura urban (opz.LM12) old grey with urban finish</p>	 <p>old dark finitura urban (opz.LM13) old dark with urban finish</p>	 <p>old black finitura urban (opz.LM14) old black with urban finish</p>	 <p>old white finitura urban (opz.LM11) old white with urban finish</p>
 <p>kaspio argento finitura flash (opz.6090) silver kaspio with flash finish</p>	 <p>kaspio oro finitura flash (opz.6089) gold kaspio with flash finish</p>	 <p>brass finitura flash (opz.5025) brass with flash finish</p>	 <p>lusema finitura luna (opz.3366) lusema with luna finish</p>
 <p>esterel finitura wraky (opz.811) esterel with wraky finish</p>	 <p>malta visone vintage finitura plamky (opz.5568) vintage mink mortar with plamky finish</p>	 <p>rovere grigio (opz.3264) grey oak</p>	 <p>rovere naturale vintage (opz.5310L) vintage natural oak</p>
 <p>noce canaletto (opz.5501) canaletto walnut</p>	 <p>noce sinfonia (opz.4625) symphony walnut</p>		



## Box alimentazione Power supply box

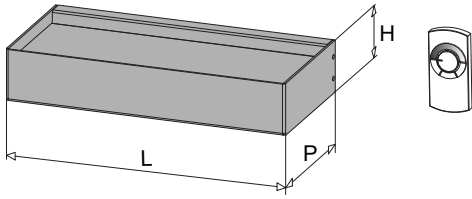

N.B.: disponibile solo per il mercato Europeo  
Note: only available for the European market

### BOX ALIMENTAZIONE MENSOLA SHELF POWER SUPPLY BOX

FINITURA Finish	A/V*	CODICE Code
■ Nero black	A	086BHM01AL11
■ Titanio titanium	A	086BHM01AL12

#### COMPONENTI INTERNI CABLATI:

**3T494502:** Driver 24V 100W con cavo e spina 110V  
(Certificazione internazionale)

**6SP704:** Spina EU standard mt2 c/connettore JST femmina

**6IN088:** Selezionatore Dual Color 60W carico massimo

**185057:** Radiocomando Dimmer 12/24V CPL

#### WIRED INTERNAL COMPONENTS:

**3T494502:** Driver 24V 100W with cable and 110V plug  
(International Certification)

**6SP704:** EU standard mt2 plug w/female JST connector

**6IN088:** Dual Color Selector 60W maximum load

**185057:** Dimmer remote control 12/24V CPL

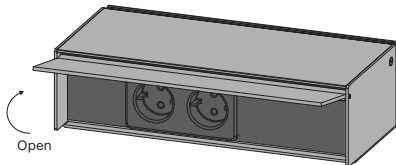
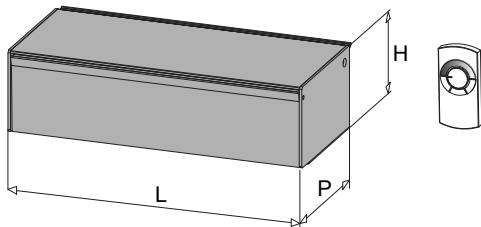

N.B.: disponibile solo per il mercato Europeo  
Note: only available for the European market

### BOX ALIMENTAZIONE MENSOLA CON PRESE ELETTRICHE POWER SUPPLY BOX SHELF WITH ELECTRICAL SOCKETS

FINITURA Finish	A/V*	CODICE Code
■ Nero black	A	086BHM02AL11
■ Titanio titanium	A	086BHM02AL12

#### COMPONENTI INTERNI CABLATI:

**3T494502:** Driver 24V 100W con cavo e spina 110V JST  
(Certificazione internazionale)

**6SP704:** Spina EU standard mt2 c/connettore JST femmina

**6IN088:** Selezionatore Dual Color 60W carico massimo

**185057:** Radiocomando Dimmer 12/24V CPL

**159102000110:** 2 Prese Schuko

**659006030500:** Cavo 3 MT c/connettore GST18

#### WIRED INTERNAL COMPONENTS:

**3T494502:** Driver 24V 100W with cable and 110V plug  
(International Certification)

**6SP704:** EU standard mt2 plug w/female JST connector

**6IN088:** Dual Color Selector 60W maximum load

**185057:** Dimmer remote control 12/24V CPL

**159102000110:** 2 Schuko sockets

**659006030500:** 3 MT cable with GST18 connector

**NB:** I Box vanno inseriti nella parte piu' estrema dx o sx della barra  
Note: The Boxes must be inserted in the most extreme right or left part of the bar

### ACCESSORI ELETTRICI (N.B.: da usare solo con punto luce comado a parete) ELECTRICAL ACCESSORIES (Note: to be used only with wall-mounted light point)

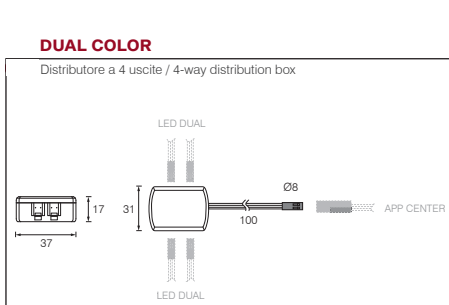

24V - 100W - CE - SELV - C - US

V IN	Hz	V OUT	W	L x P x H (mm)	EU PLUG	US PLUG
110V	50...60Hz	24V	100W	184 x 61 x 32	3T494504	24V - Cavo per connessione singola / Single connecting cable

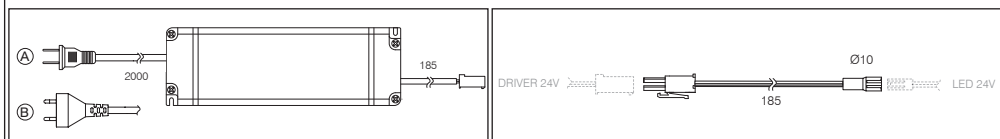

#### DESCRIZIONE Description

Distributore 4 uscite distributor 4 outputs  
Alimentatore US/Canada power supply  
Alimentatore EU power supply  
Cavo alimentazione power cable

#### CODICE Code

086BHM66  
086BHM61  
086BHM60  
086BHM65

\*A/V: A=ANODIZZATO V=VERNICIATO  
ANODIZED PAINTED

## Box alimentazione Power supply box

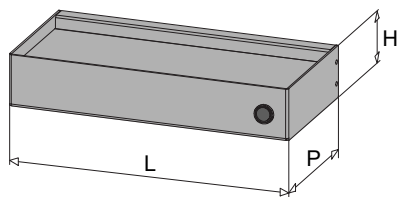

N.B.: disponibile solo per il mercato Europeo  
Note: only available for the European market

### BOX ALIMENTAZIONE MENSOLA C/PULSANTE POWER SUPPLY BOX SHELF WITH BUTTON

FINITURA Finish	A/V*	CODICE Code
■ Nero black	A	086BHM03AL11
■ Titanio titanium	A	086BHM03AL12

#### COMPONENTI INTERNI CABLATI:

**3T492803:** Driver 24V 60W con cavo e spina 110V JST  
(Certificazione CE)

**6SP704:** Spina EU standard mt2 c/connettore JST femmina

**6IN011:** Interruttore cablato

**6IN01101:** Tasto per interruttore

#### WIRED INTERNAL COMPONENTS:

**3T492803:** Driver 24V 60W with cable and 110V JST plug (CE Certification)

**6SP704:** EU standard mt2 plug w/female JST connector

**6IN011:** Wired switch

**6IN01101:** Switch button

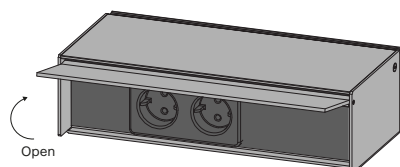
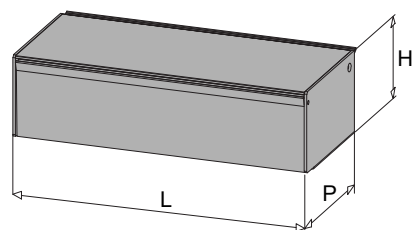

N.B.: disponibile solo per il mercato Europeo  
Note: only available for the European market

### BOX MENSOLA SOLO CON PRESE ELETTRICHE BOX SHELF ONLY WITH ELECTRICAL SOCKETS

FINITURA Finish	A/V*	CODICE Code
■ Nero black	A	086BHM07AL11
■ Titanio titanium	A	086BHM07AL12

#### COMPONENTI INTERNI CABLATI:

**159102000110:** D2 Prese Schuko

**659006030500:** Cavo 3 MT c/connettore GST18

#### WIRED INTERNAL COMPONENTS:

**159102000110:** D2 Schuko sockets

**659006030500:** 3 MT cable with GST18 connector

*NB: I Box vanno inseriti nella parte piu' estrema dx o sx della barra  
Note: The Boxes must be inserted in the most extreme right or left part of the bar*

## Accessori alluminio Aluminium accessories

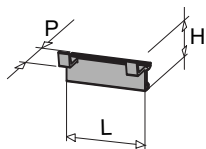

### GANCIO PORTAOGGETTI DOPPIO L.80 P.38,5 H.37 DOUBLE STORAGE HOOK L.80 D.38,5 H.37

FINITURA Finish	A/V*	CODICE Code
■ Nero black	A	086BHM10AL11
■ Titanio titanium	A	086BHM10AL12

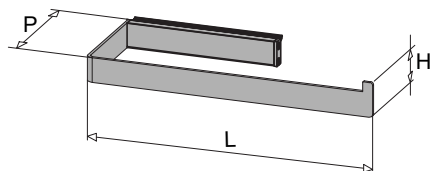

### PORTAROTOLO L.294 P.115 H.25 ROLL HOLDER L.294 D.115 H.25

FINITURA Finish	A/V*	CODICE Code
■ Nero black	A	086BHM11AL11
■ Titanio titanium	A	086BHM11AL12

### MENSOLA PIANA ALLUMINIO L.300 P.120 H.3 FLAT ALUMINUM SHELF L.300 D.120 H.3

FINITURA Finish	A/V*	CODICE Code
■ Nero black	A	086BHM20AL11
■ Titanio titanium	A	086BHM20AL12

### MENSOLA PIANA ALLUMINIO L.450 P.120 H.3 FLAT ALUMINUM SHELF L.450 D.120 H.3

FINITURA Finish	A/V*	CODICE Code
■ Nero black	A	086BHM21AL11
■ Titanio titanium	A	086BHM21AL12

### MENSOLA PIANA ALLUMINIO L.600 P.120 H.3 FLAT ALUMINUM SHELF L.600 D.120 H.3

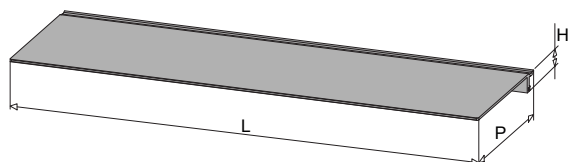

FINITURA Finish	A/V*	CODICE Code
■ Nero black	A	086BHM22AL11
■ Titanio titanium	A	086BHM22AL12

### MENSOLA PIANA ALLUMINIO L.900 P.120 H.3 FLAT ALUMINUM SHELF L.900 D.120 H.3

FINITURA Finish	A/V*	CODICE Code
■ Nero black	A	086BHM23AL11
■ Titanio titanium	A	086BHM23AL12

### MENSOLA PIANA ALLUMINIO L.1200 P.120 H.3 FLAT ALUMINUM SHELF L.1200 D.120 H.3

FINITURA Finish	A/V*	CODICE Code
■ Nero black	A	086BHM24AL11
■ Titanio titanium	A	086BHM24AL12

### MENSOLA PIANA ALLUMINIO L.1500 P.120 H.3 FLAT ALUMINUM SHELF L.1500 D.120 H.3

FINITURA Finish	A/V*	CODICE Code
■ Nero black	A	086BHM25AL11
■ Titanio titanium	A	086BHM25AL12

\*A/V: A=ANODIZZATO V=VERNICIATO  
ANODIZED PAINTED

## Accessori alluminio Aluminium accessories

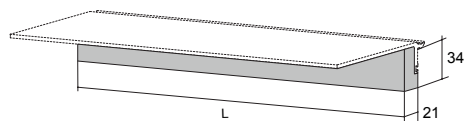

*N.B.: prima del montaggio forare il pannello per passaggio cavo.  
Non inseribile con pannello in composito*  
Note: before assembly, drill the panel for cable passage  
Cannot be inserted with composite panel

### PROFILO LUCE PER MENSOLA PROFILE LIGHT FOR SHELF

FINITURA Finish	Lunghezza Length	A/V*	CODICE Code
■ Nero black	L 30	A	086BHM70AL11
■ Titanio titanium	L 30	A	086BHM70AL12
■ Nero black	L 45	A	086BHM71AL11
■ Titanio titanium	L 45	A	086BHM71AL12
■ Nero black	L 60	A	086BHM72AL11
■ Titanio titanium	L 60	A	086BHM72AL12
■ Nero black	L 90	A	086BHM73AL11
■ Titanio titanium	L 90	A	086BHM73AL12
■ Nero black	L 120	A	086BHM74AL11
■ Titanio titanium	L 120	A	086BHM74AL12
■ Nero black	L 150	A	086BHM75AL11
■ Titanio titanium	L 150	A	086BHM75AL12

## Accessori alluminio e legno Aluminium and wood accessories

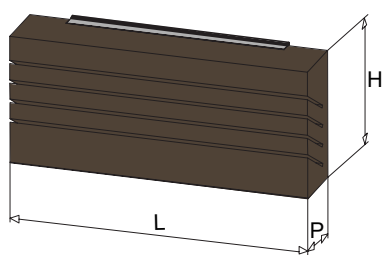

### PORTACOLTELLI LEGNO SCURO + aggancio in finitura anodica L.300 P.60 H.130 KNIFE HOLDER IN DARK WOOD + anodic finish hook L.300 D.60 H.130

FINITURA Finish	A/V*	CODICE Code
■ ■ L. Scuro - Nero dark wood - black	A	086BHM12AL11
■ ■ L. Scuro - Titanio dark wood - titanium	A	086BHM12AL12

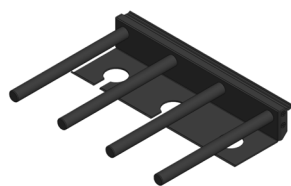

### PORTABOTTIGLIE+CALICI L.267 P.193 H.43 BOTTLE+GLASS RACK L.267 D.193 H.43

FINITURA Finish	A/V*	CODICE Code
■ Nero black	A	086BHM14AL11
■ Titanio titanium	A	086BHM14AL12

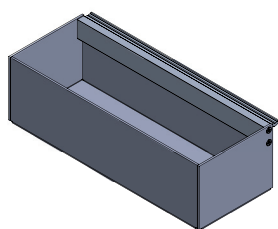

### VASCHETTA PORTA PIANTINE L.285 P.110 H.85 SEEDLING TRAY L.285 D.110 H.85

FINITURA Finish	A/V*	CODICE Code
■ Nero black	A	086BHM47AL11
■ Titanio titanium	A	086BHM47AL12

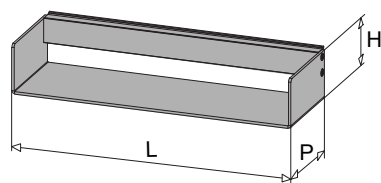

### MENSOLA PORTAOGGETTI L.300 P.90 H.50 GLOVE SHELF L.300 D.90 H.50

FINITURA Finish	A/V*	CODICE Code
■ Nero black	A	086BHM40AL11
■ Titanio titanium	A	086BHM40AL12

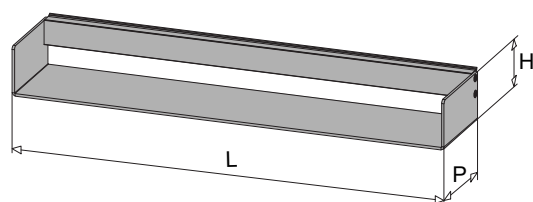

### MENSOLA PORTAOGGETTI L.450 P.90 H.50 GLOVE SHELF L4500 D.90 H.50

FINITURA Finish	A/V*	CODICE Code
■ Nero black	A	086BHM41AL11
■ Titanio titanium	A	086BHM41AL12

\*A/V: A=ANODIZZATO V=VERNICIATO  
ANODIZED PAINTED



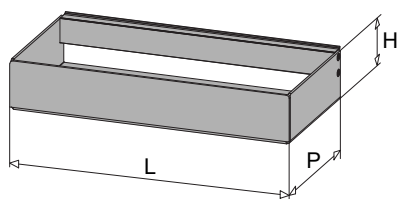

**MENSOLA PORTAOGGETTI L.300 P.140 H.50**  
GLOVE SHELF L300 D.140 H.50

FINITURA Finish	A/V*	CODICE Code
■ Nero black	A	086BHM45AL11
■ Titanio titanium	A	086BHM45AL12

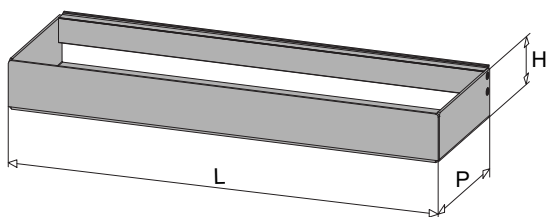

**MENSOLA PORTAOGGETTI L.450 P.140 H.50**  
GLOVE SHELF L450 D.140 H.50

FINITURA Finish	A/V*	CODICE Code
■ Nero black	A	086BHM46AL11
■ Titanio titanium	A	086BHM46AL12

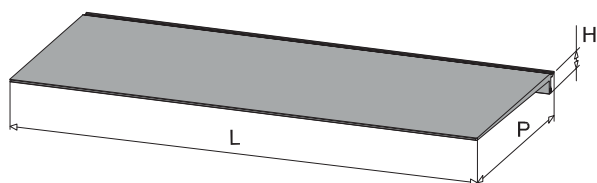

**MENSOLA PIANA ALLUMINIO L.600 P.250 H.3**  
FLAT ALUMINUM SHELF L.600 D.250 H.3

FINITURA Finish	A/V*	CODICE Code
■ Nero black	A	086BHM32AL11
■ Titanio titanium	A	086BHM32AL12

**SOLO PER COMPOSIZIONI LIVING**  
**ONLY FOR LIVING COMPOSITIONS**

*NB: Nell'inserimento della mensola P 250, assicurarsi che il fissaggio dei pannelli a muro sia adeguato.*

*Note: When inserting the W 250 shelf, make sure the fixing of the panels to the wall is adequate.*

**MENSOLA PIANA ALLUMINIO L.900 P.250 H.3**  
FLAT ALUMINUM SHELF L.900 D.250 H.3

FINITURA Finish	A/V*	CODICE Code
■ Nero black	A	086BHM33AL11
■ Titanio titanium	A	086BHM33AL12

**MENSOLA PIANA ALLUMINIO L.1200 P.250 H.3**  
FLAT ALUMINUM SHELF L.1200 D.250 H.3

FINITURA Finish	A/V*	CODICE Code
■ Nero black	A	086BHM34AL11
■ Titanio titanium	A	086BHM34AL12

**MENSOLA PIANA ALLUMINIO L.1500 P.250 H.3**  
FLAT ALUMINUM SHELF L.1500 D.250 H.3

FINITURA Finish	A/V*	CODICE Code
■ Nero black	A	086BHM35AL11
■ Titanio titanium	A	086BHM35AL12

\*A/V: A=ANODIZZATO V=VERNICIATO  
ANODIZED PAINTED

**PANNELLO SCHIENALE PER FUOCHI ALLUMINIO L.600 P.12 H.310**  
**BACK PANEL FOR ALUMINUM FIREPLACE L.600 D.12 H.310**

FINITURA Finish	A/V*	CODICE Code
■ Nero black	A	086BHM16AL11
■ Titanio titanium	A	086BHM16AL12

**PANNELLO SCHIENALE PER FUOCHI ALLUMINIO L.600 P.12 H.340**  
**BACK PANEL FOR ALUMINUM FIREPLACE L.600 D.12 H.340**

FINITURA Finish	A/V*	CODICE Code
■ Nero black	A	086BHM50AL11
■ Titanio titanium	A	086BHM50AL12

**PANNELLO SCHIENALE PER FUOCHI ALLUMINIO L.750 P.12 H.310**  
**BACK PANEL FOR ALUMINUM FIREPLACE L.750 D.12 H.310**

FINITURA Finish	A/V*	CODICE Code
■ Nero black	A	086BHM17AL11
■ Titanio titanium	A	086BHM17AL12

**PANNELLO SCHIENALE PER FUOCHI ALLUMINIO L.750 P.12 H.340**  
**BACK PANEL FOR ALUMINUM FIREPLACE L.750 D.12 H.340**

FINITURA Finish	A/V*	CODICE Code
■ Nero black	A	086BHM51AL11
■ Titanio titanium	A	086BHM51AL12

**PANNELLO SCHIENALE PER FUOCHI ALLUMINIO L.900 P.12 H.310**  
**BACK PANEL FOR ALUMINUM FIREPLACE L.900 D.12 H.310**

FINITURA Finish	A/V*	CODICE Code
■ Nero black	A	086BHM19AL11
■ Titanio titanium	A	086BHM19AL12

**PANNELLO SCHIENALE PER FUOCHI ALLUMINIO L.900 P.12 H.340**  
**BACK PANEL FOR ALUMINUM FIREPLACE L.900 D.12 H.340**

FINITURA Finish	A/V*	CODICE Code
■ Nero black	A	086BHM53AL11
■ Titanio titanium	A	086BHM53AL12

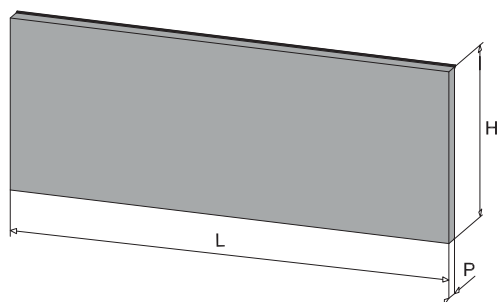

**GANCIO DOPPIO**  
Double Hook

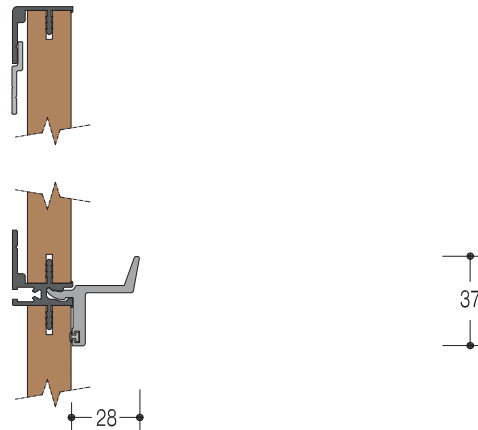

**PORTAROTOLO**  
Roll Holder

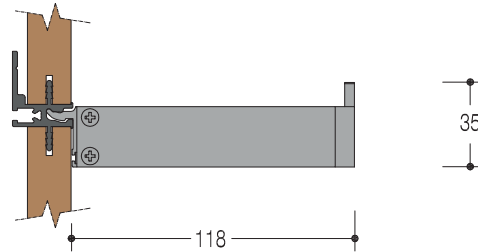

**PORTAOGGETTI**  
Glove Holder

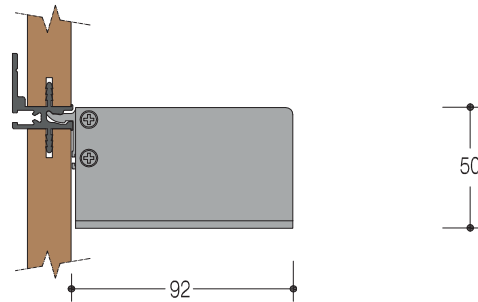

**PORTACOLTELLI**  
Knife Holder

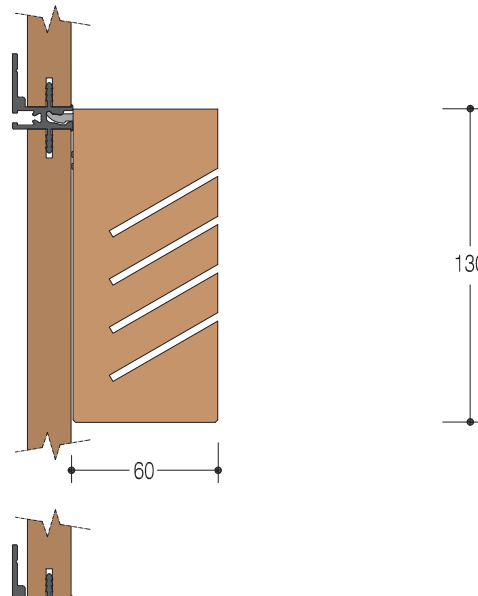

**MENSOLA PROF. 130**  
Shelf Depth.130

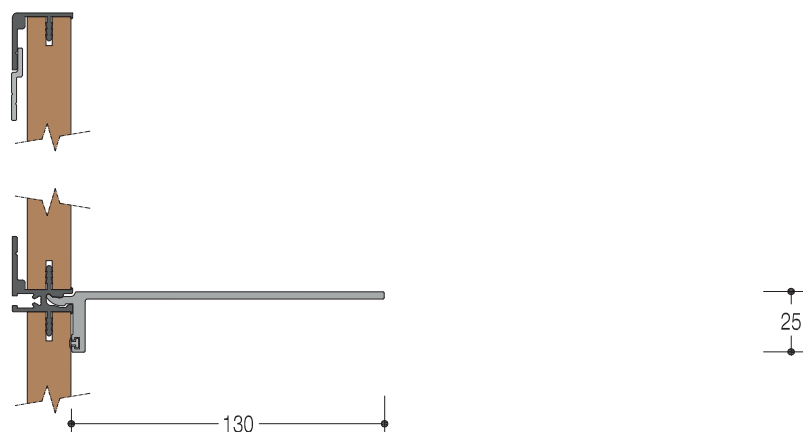

**MENSOLA PROF. 250**  
Shelf Depth.250

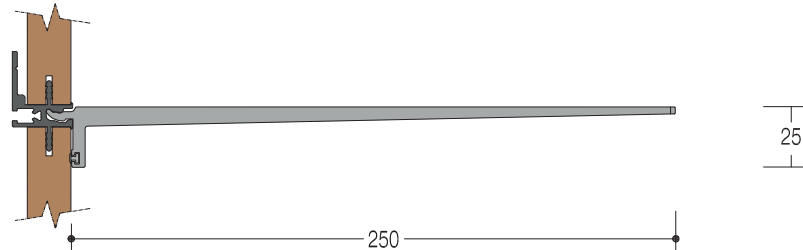

**PROFILO LED PER MENSOLA  
PROF. 130/250**  
Led Profile for Shelf Depth.130/250

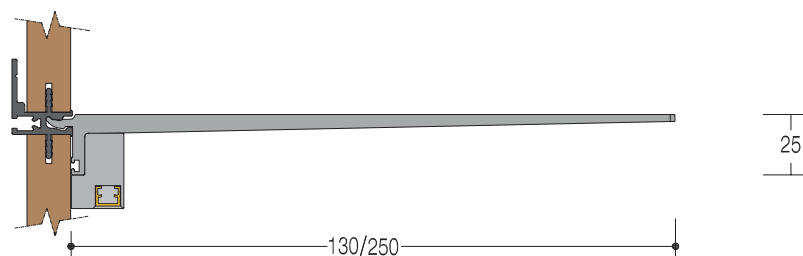

**BOX ILLUMINAZIONE**  
Lighting Box

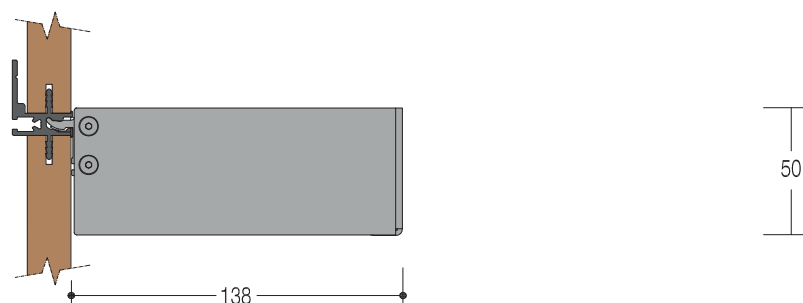

**BOX PRESE**  
Socket Box

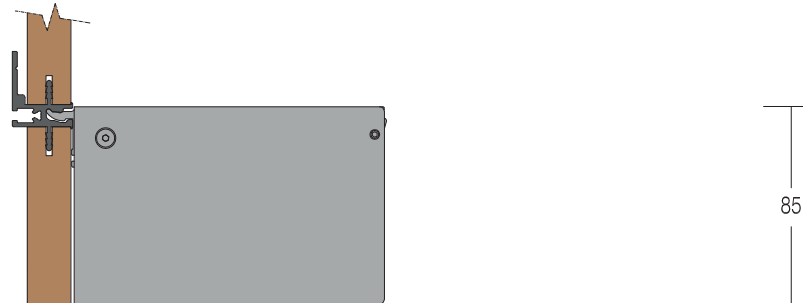

## CATEGORIA PARETE WALL CATEGORY

Rappresentazione di soluzioni per rivestimento parete, in funzione degli allineamenti dei pensili della cucina di riferimento. Le quote sono puramente indicative e vanno adattate alla reale condizione reali di installazione (irregolarità della pavimentazione/regolazione dei piedi).

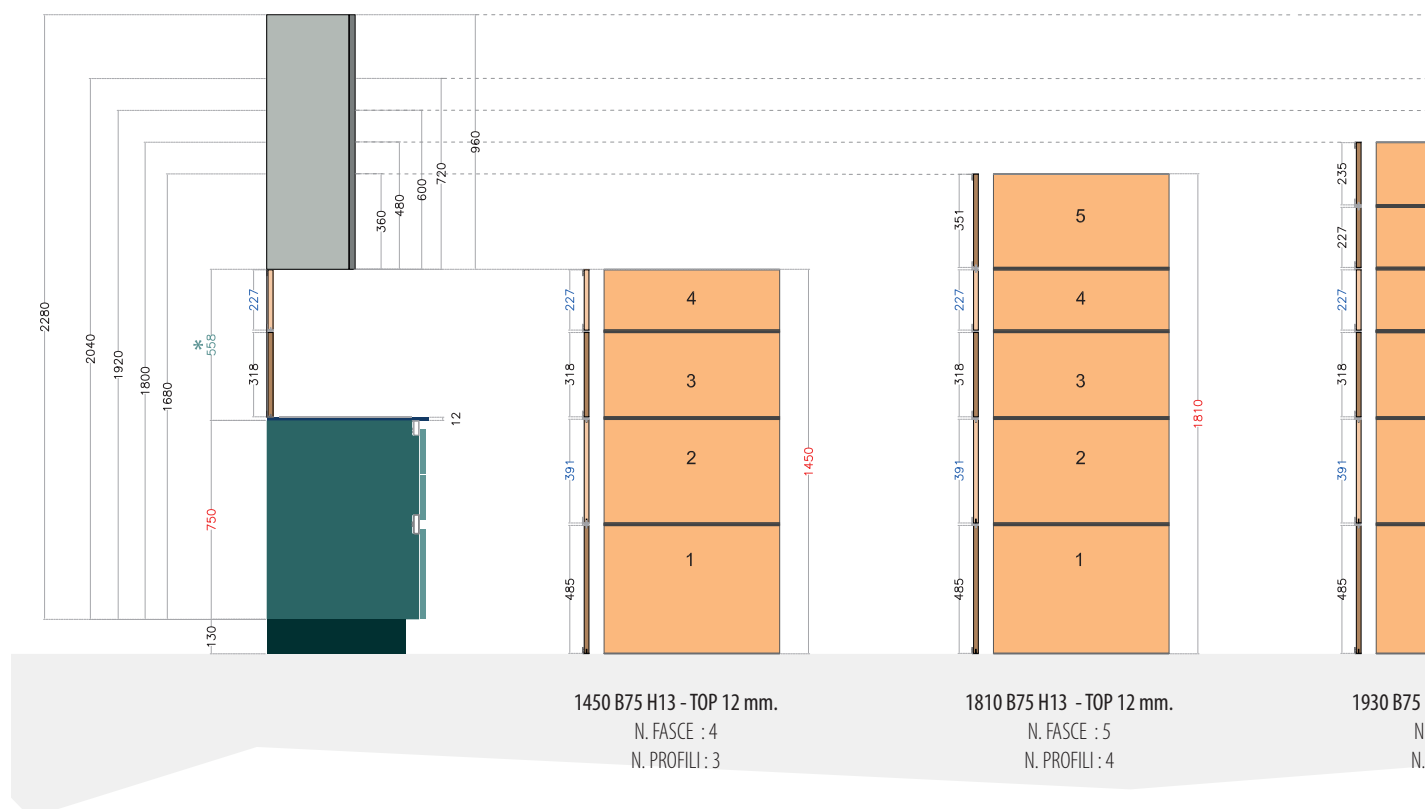

### QUOTE JOLLY AD ALTEZZA VARIABILE

Le altezze indicate nelle fasce n. 2 e n.4 possono variare la loro altezza in relazione allo spessore del piano. Questo per mantenere sempre gli allineamenti per ogni tipologia di top.

Nel disegno presente nella parte superiore vengono riportati gli allineamenti considerando il top spessore 12 mm. Per le altre tipologie occorre considerare le seguenti differenze:

**TOP H 20** = H + 8 mm per FASCIA 2  
H - 8 mm per FASCIA 4

**TOP H 22** = H + 10 mm per FASCIA 2  
H - 10 mm per FASCIA 4

**TOP H 30** = H + 18 mm per FASCIA 2  
H - 18 mm per FASCIA 4

**TOP H 40** = H + 28 mm per FASCIA 2  
H - 28 mm per FASCIA 4

**BASE H 75 bridge ZOCCOLO 13**  
**BASE H 75 bridge PLINTH 13**

Representation of solutions for wall covering, depending on the alignments of the reference kitchen wall units. The dimensions are purely indicative and should be adapted to the actual condition of installation (unevenness of flooring/footing adjustment).

- **QUOTE DI RIFERIMENTO**  
REFERENCE QUOTE
- **QUOTE JOLLY (H VARIABILE)**  
JOLLY QUOTE (H VARIABLE)
- **QUOTE FISSE**  
FIXED DIMENSION
- **QUOTE H TRA BASE E PENSILE**  
DIMENSIONS BETWEEN BASE AND CABINET

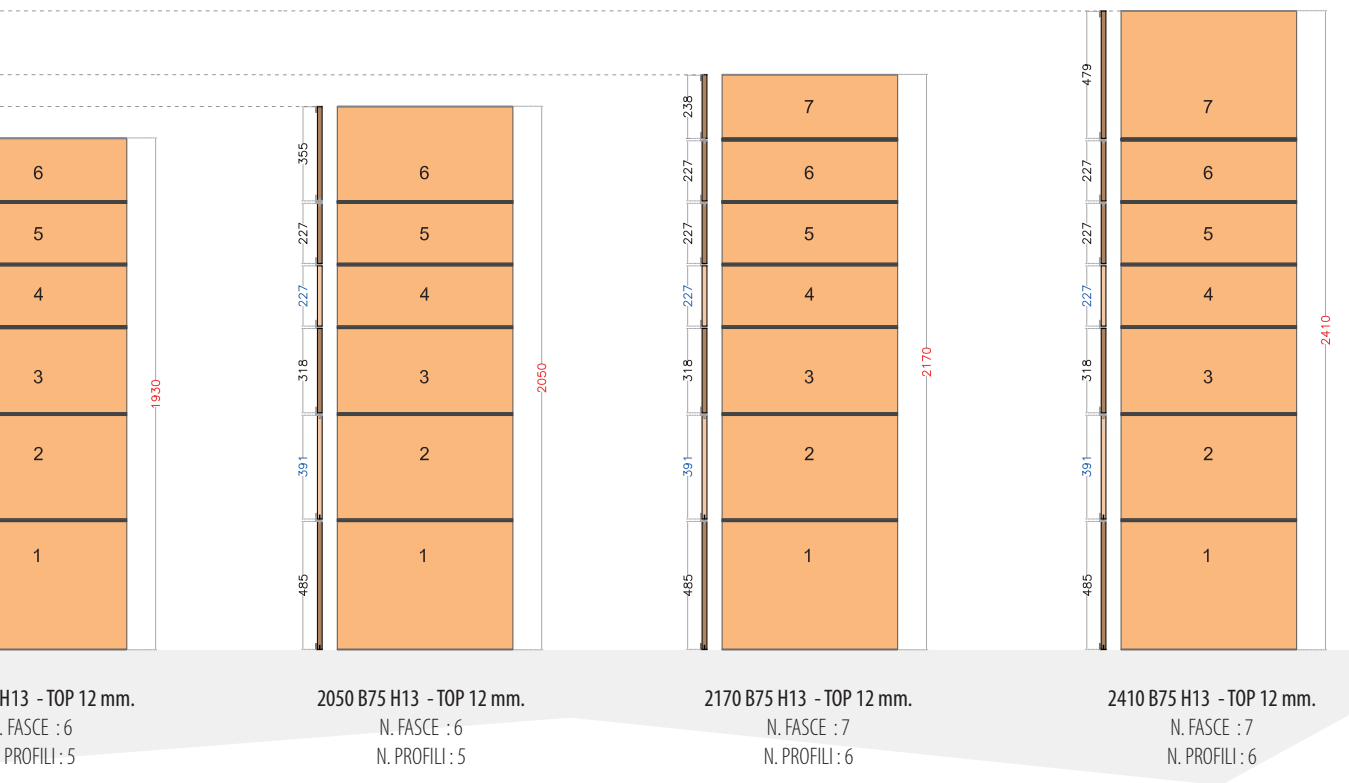

**DIMENSIONS WITH VARIABLE HEIGHT**

The heights indicated in the bands n. 2 and n.4 can change their height in relation to the top thickness. This solution it was designed for maintaining alignments for each type of top.

The drawings in the upper, consider the top with thick 12 mm. For the other types, must be considered the difference below:

- TOP H 20** = H + 8 mm for band 2  
H - 8 mm for band 4
- TOP H 22** = H + 10 mm for band 2  
H - 10 mm for band 4
- TOP H 30** = H + 18 mm for band 2  
H - 18 mm for band 4
- TOP H 40** = H + 28 mm for band 2  
H - 28 mm for band 4

## CATEGORIA PARETE WALL CATEGORY

Rappresentazione di soluzioni per rivestimento parete, in funzione degli allineamenti dei pensili della cucina di riferimento. Le quote sono puramente indicative e vanno adattate alla reale condizione reali di installazione (irregolarità della pavimentazione/regolazione dei piedi).

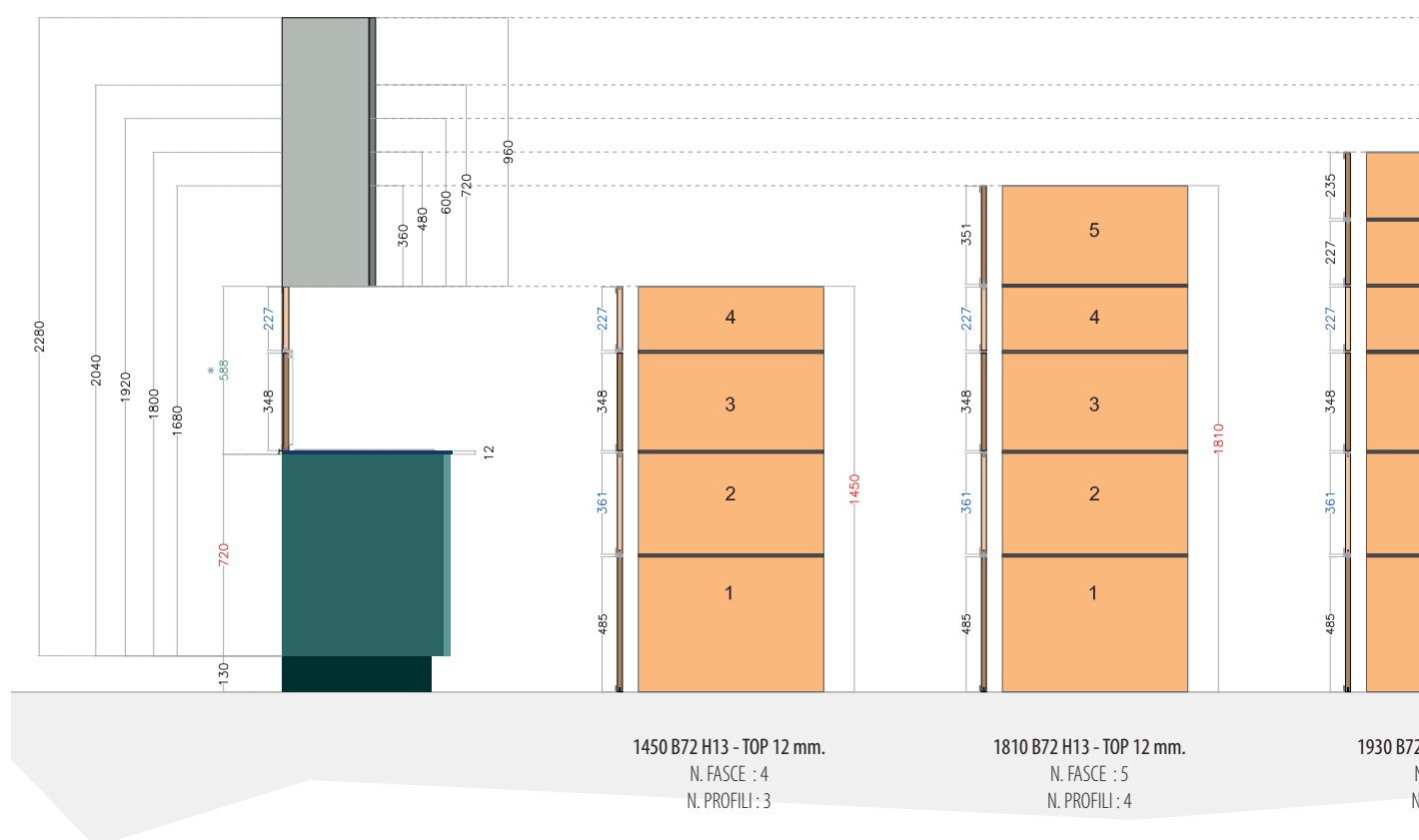

### QUOTE JOLLY AD ALTEZZA VARIABILE

Le altezze indicate nelle fasce n. 2 e n.4 possono variare la loro altezza in relazione allo spessore del piano. Questo per mantenere sempre gli allineamenti per ogni tipologia di top.

Nel disegno presente nella parte superiore vengono riportati gli allineamenti considerando il top spessore 12 mm. Per le altre tipologie occorre considerare le seguenti differenze:

**TOP H 20** = H + 8 mm per FASCIA 2  
H - 8 mm per FASCIA 4

**TOP H 22** = H + 10 mm per FASCIA 2  
H - 10 mm per FASCIA 4

**TOP H 30** = H + 18 mm per FASCIA 2  
H - 18 mm per FASCIA 4

**TOP H 40** = H + 28 mm per FASCIA 2  
H - 28 mm per FASCIA 4

**BASE H 72 neck ZOCCOLO 13**  
**BASE H 72 neck PLINTH 13**

Representation of solutions for wall covering, depending on the alignments of the reference kitchen wall units. The dimensions are purely indicative and should be adapted to the actual condition of installation (unevenness of flooring/footing adjustment).

- **QUOTE DI RIFERIMENTO**  
REFERENCE QUOTE
- **QUOTE JOLLY (H VARIABILE)**  
JOLLY QUOTE (H VARIABLE)
- **QUOTE FISSE**  
FIXED DIMENSION
- **QUOTE H TRA BASE E PENSILE**  
DIMENSIONS BETWEEN BASE AND CABINET

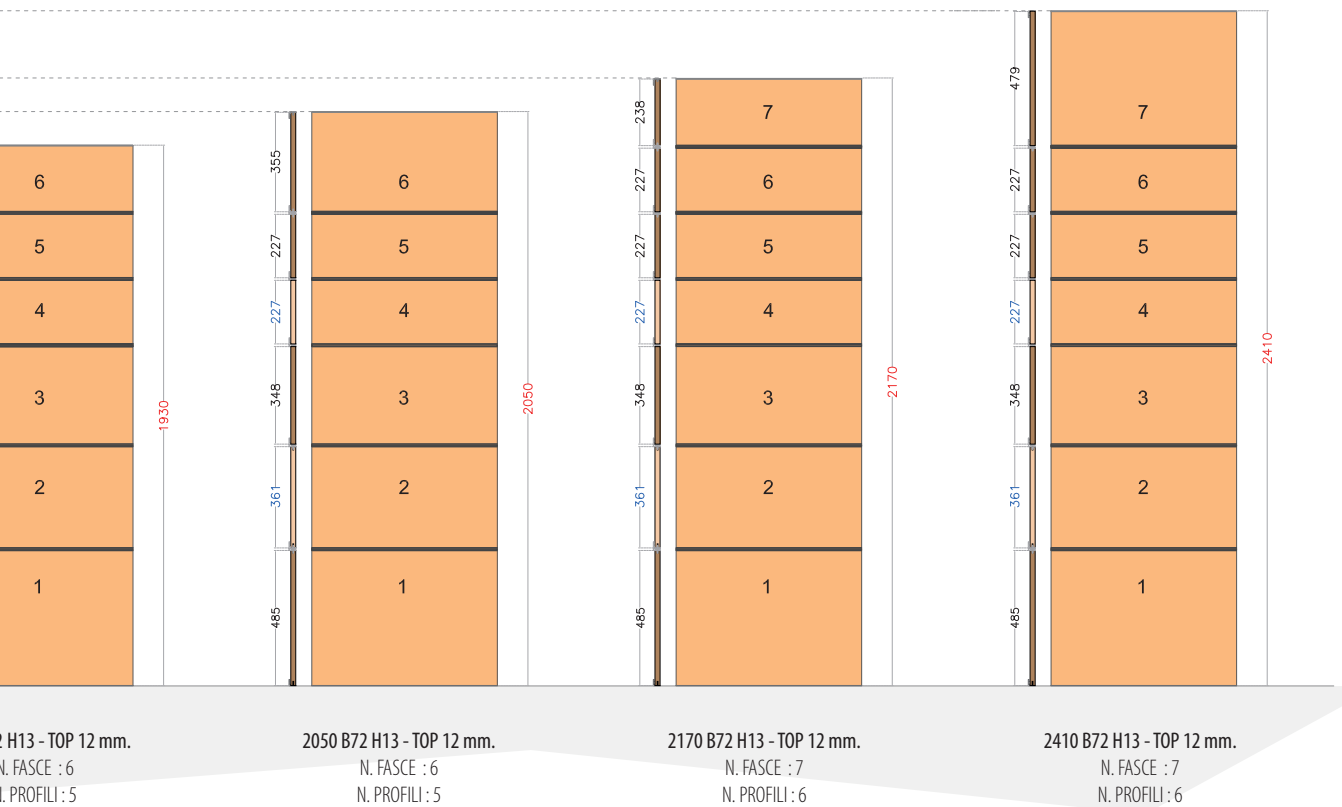

**DIMENSIONS WITH VARIABLE HEIGHT**

The heights indicated in the bands n. 2 and n.4 can change their height in relation to the top thickness. This solution it was designed for maintaining alignments for each type of top.

The drawings in the upper, consider the top with thick 12 mm. For the other types, must be considered the difference below:

- TOP H 20** = H + 8 mm for band 2  
H - 8 mm for band 4
- TOP H 22** = H + 10 mm for band 2  
H - 10 mm for band 4
- TOP H 30** = H + 18 mm for band 2  
H - 18 mm for band 4
- TOP H 40** = H + 28 mm for band 2  
H - 28 mm for band 4



## CATEGORIA PARETE WALL CATEGORY

Rappresentazione di soluzioni per rivestimento parete, in funzione degli allineamenti dei pensili della cucina di riferimento. Le quote sono puramente indicative e vanno adattate alla reale condizione reali di installazione (irregolarità della pavimentazione/regolazione dei piedi).

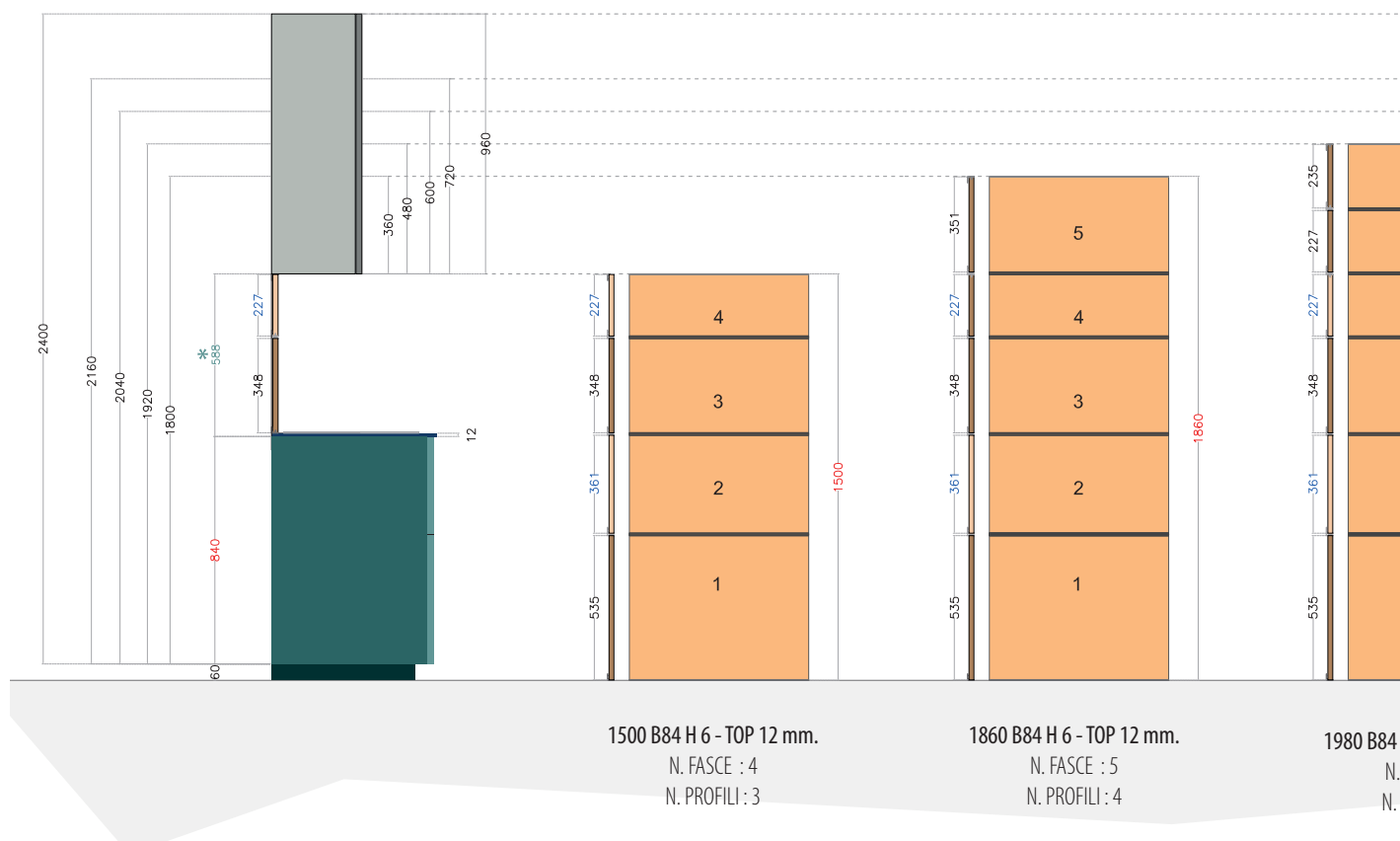

### QUOTE JOLLY AD ALTEZZA VARIABILE

Le altezze indicate nelle fasce n. 2 e n.4 possono variare la loro altezza in relazione allo spessore del piano. Questo per mantenere sempre gli allineamenti per ogni tipologia di top.

Nel disegno presente nella parte superiore vengono riportati gli allineamenti considerando il top spessore 12 mm. Per le altre tipologie occorre considerare le seguenti differenze:

**TOP H 20** = H + 8 mm per FASCIA 2  
H - 8 mm per FASCIA 4

**TOP H 22** = H + 10 mm per FASCIA 2  
H - 10 mm per FASCIA 4

**TOP H 30** = H + 18 mm per FASCIA 2  
H - 18 mm per FASCIA 4

**TOP H 40** = H + 28 mm per FASCIA 2  
H - 28 mm per FASCIA 4

**BASE H 84 bridge ZOCCOLO 13**  
**BASE H 84 bridge PLINTH 13**

Representation of solutions for wall covering, depending on the alignments of the reference kitchen wall units. The dimensions are purely indicative and should be adapted to the actual condition of installation (unevenness of flooring/footing adjustment).

- QUOTE DI RIFERIMENTO  
REFERENCE QUOTE
- QUOTE JOLLY (H VARIABILE)  
JOLLY QUOTE (H VARIABLE)
- QUOTE FISSE  
FIXED DIMENSION
- QUOTE H TRA BASE E PENSILE  
DIMENSIONS BETWEEN BASE AND CABINET

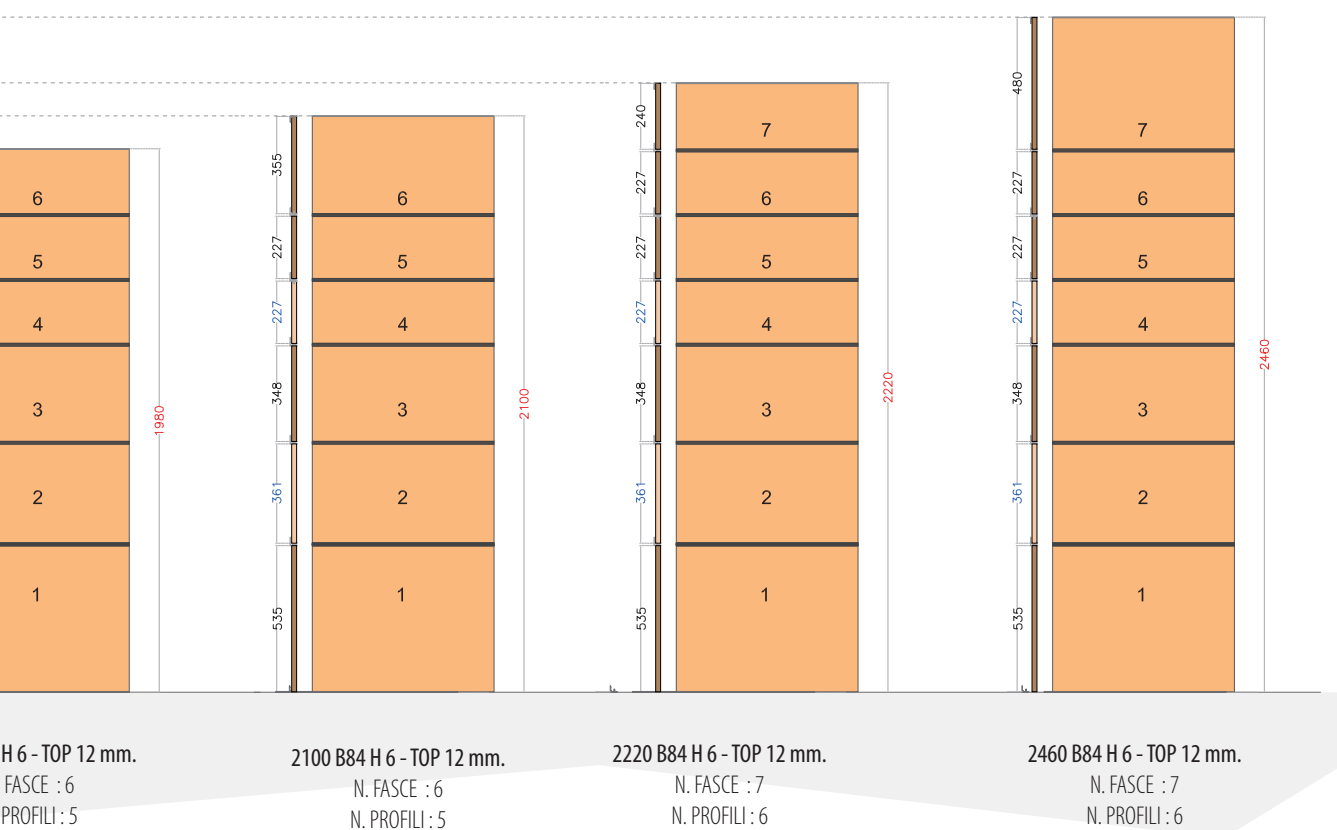

#### DIMENSIONS WITH VARIABLE HEIGHT

The heights indicated in the bands n. 2 and n.4 can change their height in relation to the top thickness. This solution it was designed for maintaining alignments for each type of top.

The drawings in the upper, consider the top with thick 12 mm. For the other types, must be considered the difference below:

**TOP H 20** = H + 8 mm for band 2  
H - 8 mm for band 4

**TOP H 22** = H + 10 mm for band 2  
H - 10 mm for band 4

**TOP H 30** = H + 18 mm for band 2  
H - 18 mm for band 4

**TOP H 40** = H + 28 mm for band 2  
H - 28 mm for band 4

## CATEGORIA PARETE WALL CATEGORY

Rappresentazione di soluzioni per rivestimento parete, in funzione degli allineamenti dei pensili della cucina di riferimento. Le quote sono puramente indicative e vanno adattate alla reale condizione reali di installazione (irregolarità della pavimentazione/regolazione dei piedi).

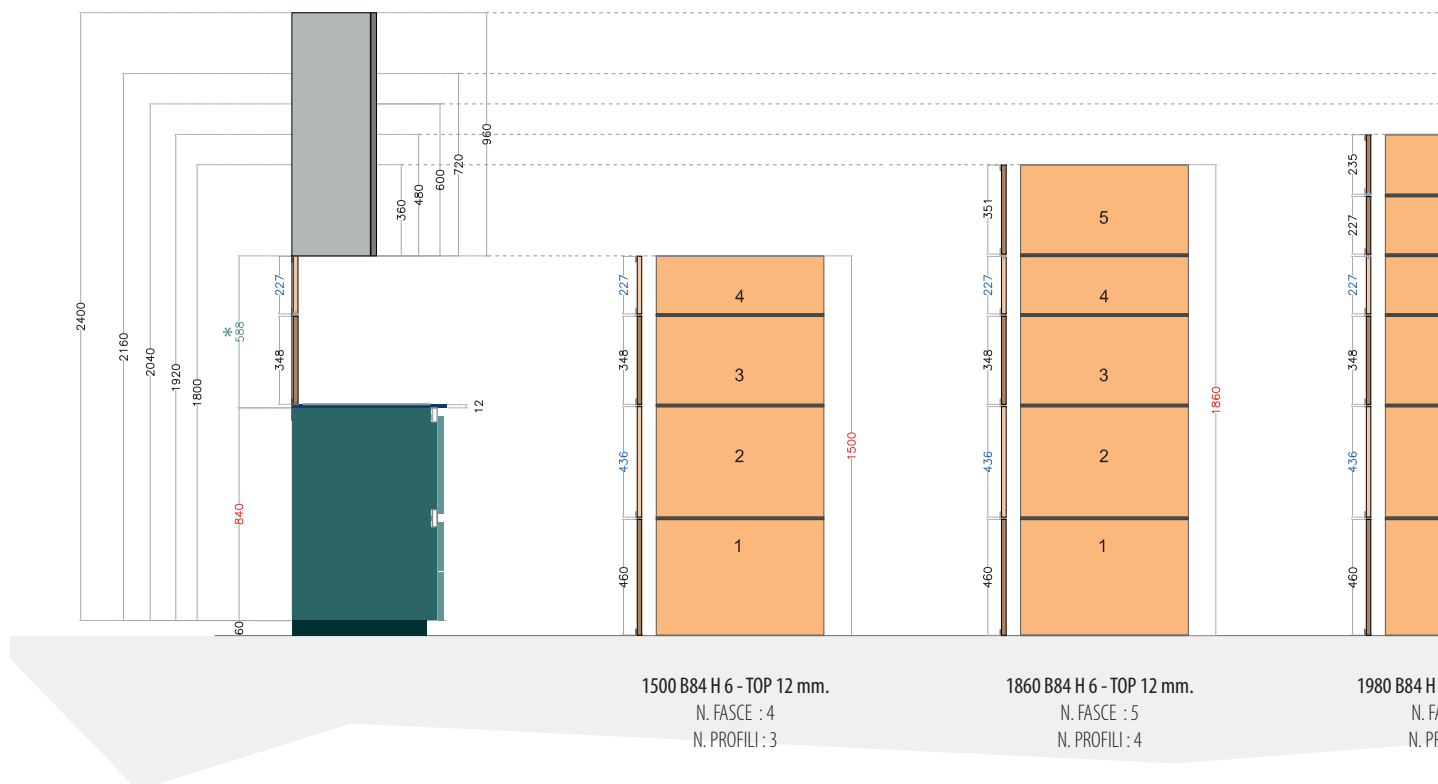

### QUOTE JOLLY AD ALTEZZA VARIABILE

Le altezze indicate nelle fasce n. 2 e n.4 possono variare la loro altezza in relazione allo spessore del piano. Questo per mantenere sempre gli allineamenti per ogni tipologia di top.

Nel disegno presente nella parte superiore vengono riportati gli allineamenti considerando il top spessore 12 mm. Per le altre tipologie occorre considerare le seguenti differenze:

**TOP H 20** = H + 8 mm per FASCIA 2  
H - 8 mm per FASCIA 4

**TOP H 22** = H + 10 mm per FASCIA 2  
H - 10 mm per FASCIA 4

**TOP H 30** = H + 18 mm per FASCIA 2  
H - 18 mm per FASCIA 4

**TOP H 40** = H + 28 mm per FASCIA 2  
H - 28 mm per FASCIA 4

**BASE H 84 neck ZOCCOLO 13**  
**BASE H 84 neck PLINTH 13**

Representation of solutions for wall covering, depending on the alignments of the reference kitchen wall units. The dimensions are purely indicative and should be adapted to the actual condition of installation (unevenness of flooring/footing adjustment).

- **QUOTE DI RIFERIMENTO**  
REFERENCE QUOTE
- **QUOTE JOLLY (H VARIABILE)**  
JOLLY QUOTE (H VARIABLE)
- **QUOTE FISSE**  
FIXED DIMENSION
- **QUOTE H TRA BASE E PENSILE**  
DIMENSIONS BETWEEN BASE AND CABINET

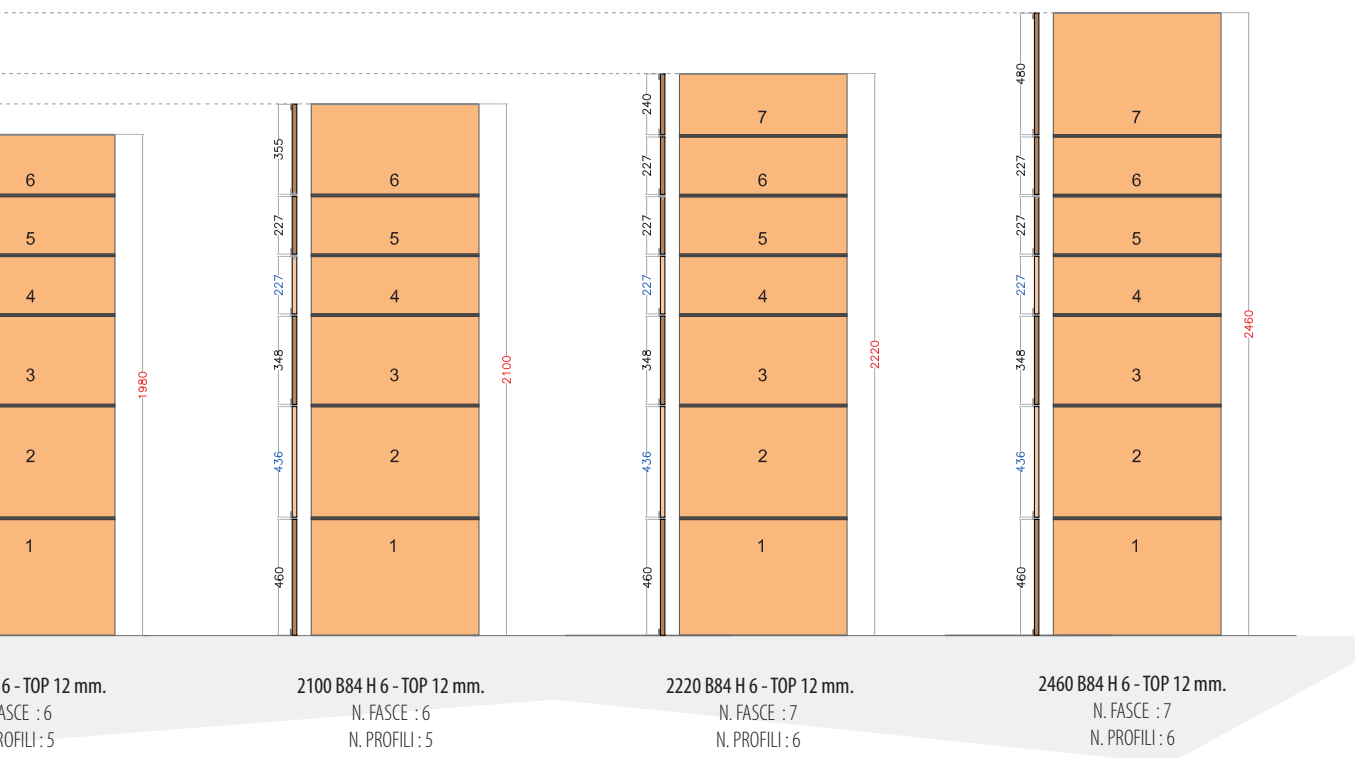

**DIMENSIONS WITH VARIABLE HEIGHT**

The heights indicated in the bands n. 2 and n.4 can change their height in relation to the top thickness. This solution it was designed for maintaining alignments for each type of top.

The drawings in the upper, consider the top with thick 12 mm. For the other types, must be considered the difference below:

- TOP H 20** = H + 8 mm for band 2  
H - 8 mm for band 4
- TOP H 22** = H + 10 mm for band 2  
H - 10 mm for band 4
- TOP H 30** = H + 18 mm for band 2  
H - 18 mm for band 4
- TOP H 40** = H + 28 mm for band 2  
H - 28 mm for band 4

## LIVING LIVING AREA

La categoria living rappresenta la soluzione di massima personalizzazione. E' pensata per dare la possibilità di scegliere liberamente il numero di profili e di pannelli nella composizione.

The living category is the solution for the maximum customization. Its designed to give the possibility to choose the composition, freely, both the number of profiles and panels.

### ESPLOSO COMPONENTI PER COMPOSIZIONE LIVING - BLOWN-UP COMPONENTS FOR LIVING COMPOSITION

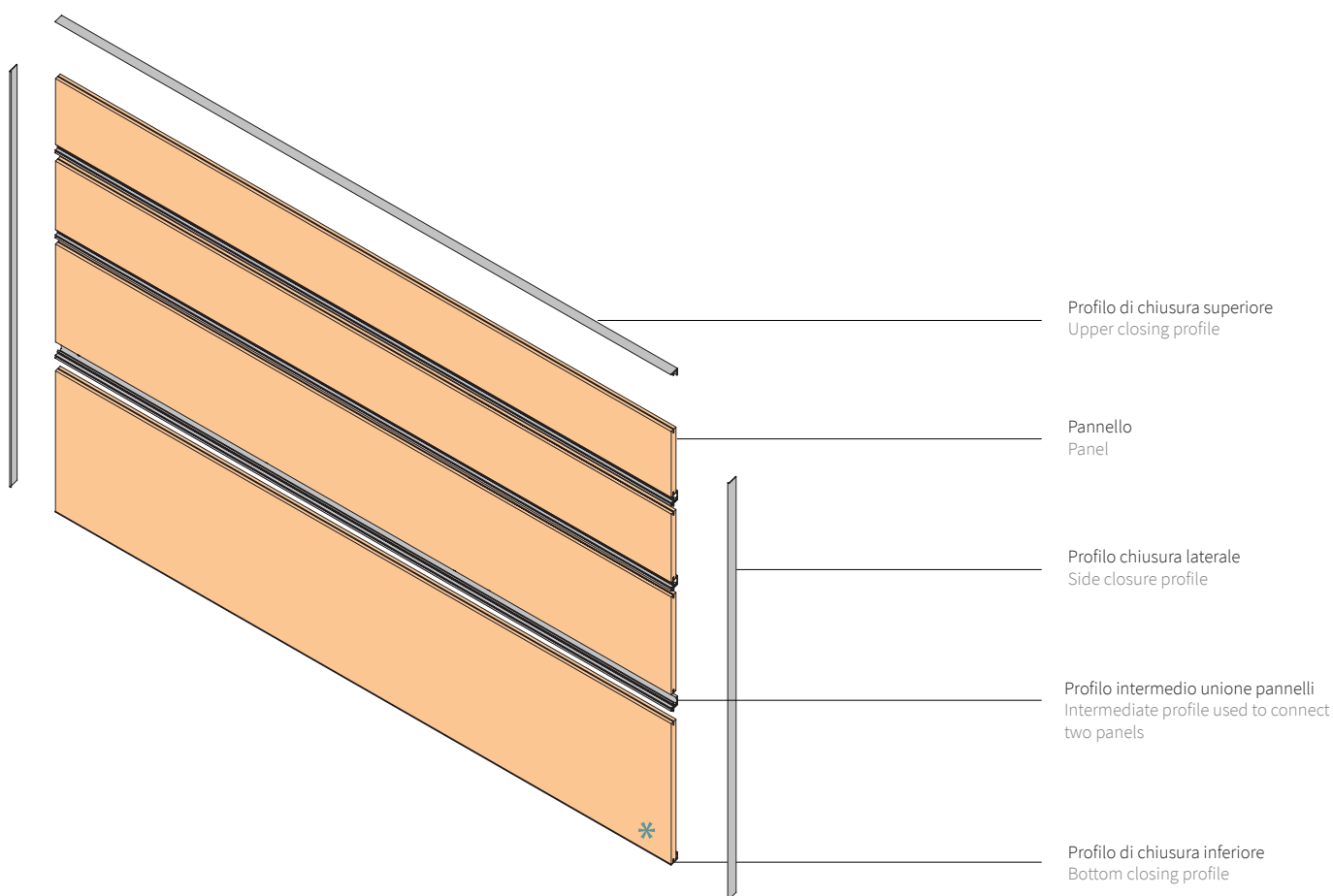

\*  
Opzione pannello inferiore in GRES, QUARZO o HPL solo per categoria CUCINA  
Option bottom panel in STONEWARE ,QUARTZ or HPL is available only for KITCHEN category

### FINITURE PANNELLI - PANEL FINISHES

Le finiture dei pannelli possono essere delle seguenti categorie:  
MELAMINICO - LAMINATO - LACCATO UV - FENIX - WOOD - MATHERA - IMPIALLACCIATO

The panel finishes can be made in the categories below:  
MELAMINE - LAMINATE - UV LACQUERED - FENIX - WOOD - MATHERA - VENEERED

---

**Finiture Alluminio**  
**Aluminum Finishes**

---

**Nero**  
Anodizzato  
**Black**  
anodized



**Titanio**  
Anodizzato  
**Titanium**  
anodized



---

**Finiture Legno**  
**Wood Finishes**

---

**Legno**  
**Scuro**  
Wood  
dark

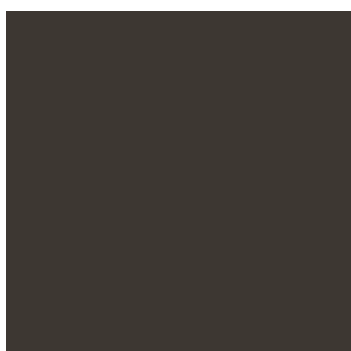

GRUPPOLUBE



PARETE BLUES

2023





# PARETE "BLUES"

## "BLUES" WALL



Noce canaletto con fondo nero  
Noce canaletto with black bottom

BLUES è un pannello decorativo sp. 19 mm, composto da un fondo in MDF in pasta nera e listelli verticali squadrati L 15 mm in laminato finitura Noce canaletto.

Disponibile nella misura massima H 280 L 60 cm.

**Possibilità di realizzare fuori misura in altezza e in larghezza con addebito dell'intero pannello**

BLUES is a 19 mm thick decorative panel consisting of a black paste MDF base and 15 mm W squared vertical slats in Canaletto Walnut finish laminate.

Available in the maximum size H 280 W 60 cm.

**Possibility of oversizing in height and width with charge of the entire panel**

Pannello H 280 L 60 sp. 1,9 cm  
Panel H 280 W 60 th. 1,9 cm

cod.086PBB01

Maggiorazione taglio/foro  
Surcharge cut out/hole

cod.T9LSPB

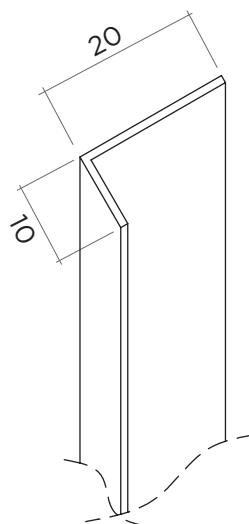
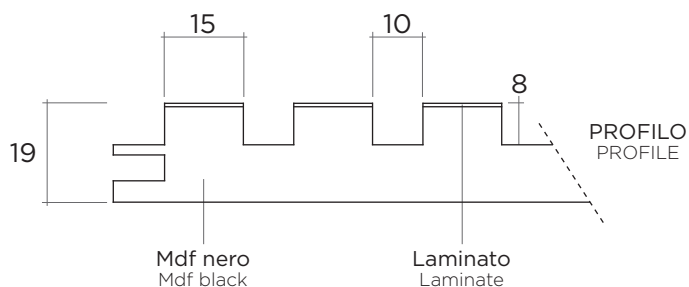

### ACCESSORI ACCESSORIES

Profilo angolare di chiusura

Misure: 20x10x2800 mm

**Obbligatorio nella parte inferiore del pannello. Nelle parti laterali inserire solo se il bordo del pannello è a vista.**

Closing angle profile

Dimensions: 20x10x2800 mm

**Mandatory in the lower part of the panel.**

**In the side parts, only insert if the edge of the panel is visible.**

Profilo angolare cod.086PBB10  
Corner profile