

GRUPPOLUBE



ACCESSORI PLUS  
ACCESSORI PER CASSETTO 2023

# PORTAPOSATE "PLUS" PER CASSETTI

## "PLUS" CUTLERY TRAY FOR DRAWERS

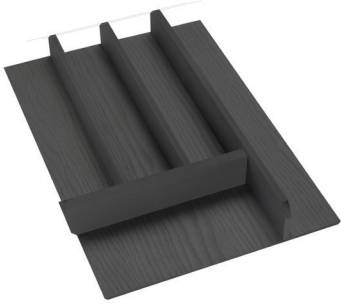
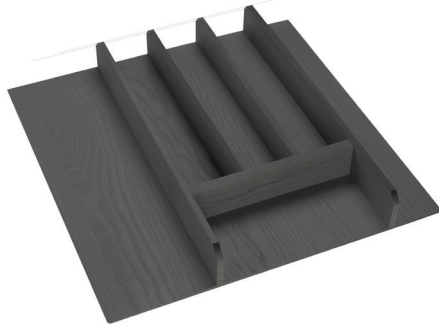
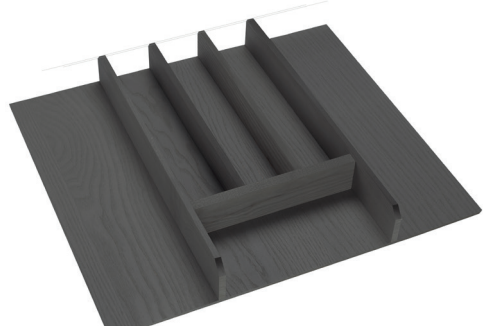
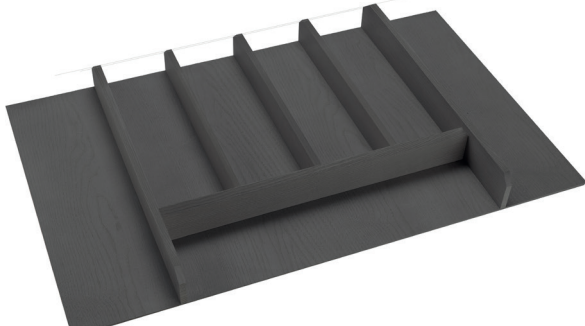



	<p><b>Portaposate 45</b> finitura rovere grigio</p> <p>Cutlery tray 45 grey oak finish</p>	<p><b>CODICE / CODE No.</b></p>	
	<p><b>Portaposate 60</b> finitura rovere grigio</p> <p>Cutlery tray 60 grey oak finish</p>	<p><b>08709102</b></p>	
	<p><b>Portaposate 75</b> finitura rovere grigio</p> <p>Cutlery tray 75 grey oak finish</p>	<p><b>08709104</b></p>	
	<p><b>Portaposate 90</b> finitura rovere grigio</p> <p>Cutlery tray 90 grey oak finish</p>	<p><b>08709105</b></p>	<p><b>08709106</b></p>

# ACCESSORI "PLUS" PER CASSETTI



## "PLUS" ACCESSORIES FOR DRAWERS

 <p>A black, rectangular knives holder with a textured surface and a small lip at the top.</p>	<p><b>Portacoltelli</b> finitura rovere grigio</p> <p>Knives holder grey oak finish</p>	<p><b>CODICE / CODE No.</b></p>	
 <p>A black, rectangular spice rack with a textured surface and a small lip at the top.</p>	<p><b>Portaspezie</b> finitura rovere grigio</p> <p>Spice rack grey oak finish</p>	<p><b>08709120</b></p>	
 <p>A light-colored wooden chopping board with a textured surface and a small lip at the top.</p>	<p><b>Tagliere per cassetto</b> finitura abete naturale</p> <p>Chopping board natural fir finish</p>	<p><b>08709121</b></p>	
	<p><b>08709123</b></p>		

## ACCESSORI "PLUS" PER CESTONI "PLUS" ACCESSORIES FOR DEEP DRAWERS

	<p><b>Porta piatti-padelle per cestone finitura rovere grigio</b></p> <p>Plates rack for deep drawer grey oak finish</p>	<p><b>CODICE / CODE No.</b></p>	
	<p><b>Porta piatti-padelle per cestone finitura rovere grigio</b></p> <p>Plates rack for deep drawer grey oak finish</p>	<p><b>08709134</b></p>	
	<p><b>Porta piatti-padelle per cestone finitura rovere grigio</b></p> <p>Plates rack for deep drawer grey oak finish</p>	<p><b>08709135</b></p>	
	<p><b>Porta piatti-padelle per cestone finitura rovere grigio</b></p> <p>Plates rack for deep drawer grey oak finish</p>	<p><b>08709136</b></p>	
		<p>45</p>	
		<p>60</p>	
		<p>75</p>	
		<p>90</p>	

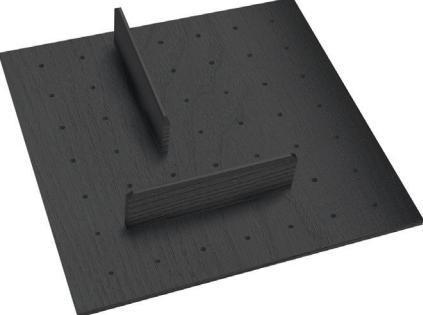
## ACCESSORI "PLUS" PER CESTONI "PLUS" ACCESSORIES FOR DEEP DRAWERS

		CODICE / CODE No.	
	<p><b>Pianale con 2 palette da 120 mm</b> finitura rovere grigio</p> <p>Platform with 2 pallets from 120 mm grey oak finish</p>	<p>45</p> <p><b>08709141</b></p>	
	<p><b>Pianale con 2 palette da 240 mm</b> finitura rovere grigio</p> <p>Platform with 2 pallets from 240 mm grey oak finish</p>	<p>60</p> <p><b>08709142</b></p>	
	<p><b>Pianale con 2 palette da 120 mm e 2 palette da 240 mm</b> finitura rovere grigio</p> <p>Platform with 2 pallets 120 mm and 2 paddles from 240 mm grey oak finish</p>	<p>75</p> <p><b>08709143</b></p>	
	<p><b>Pianale con 2 palette da 120 mm e 4 palette da 240 mm</b> finitura rovere grigio</p> <p>Platform with 2 pallets 120 mm and 4 paddles from 240 mm grey oak finish</p>	<p>90</p> <p><b>08709144</b></p>	

GRUPPOLUBE



ACCESSORI RATIO  
ACCESSORI PER CASSETTO 2023

---

Finiture Alluminio Aluminum finishes

---

**Titanio**  
Anodizzato

**Titanium**  
Anodized

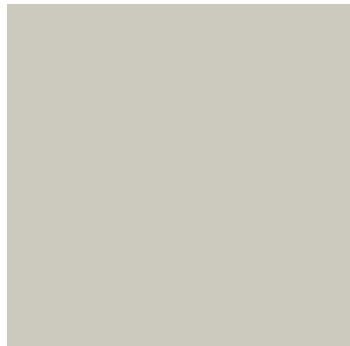

**Silver Dark**  
Verniciato

**Silver Dark**  
Painted



---

Finiture Legno Wood finishes

---

**Legno**  
**Scuro**

**Dark**  
**Wood**

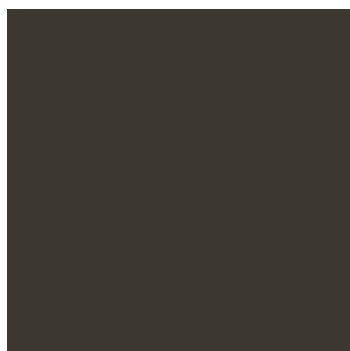

**RATIO** è un sistema di accessori per interno cassetti dedicato alla cucina che trasforma il disordine quotidiano in spazi ben organizzati.

La flessibilità di **RATIO**, grazie ai suoi molteplici accessori, consente di trovare più facilmente quello che serve contando di tenere tutto a portata di mano mentre cucini.

**RATIO** is an interior drawer accessory system dedicated to the kitchen that transforms everyday clutter into well-organised spaces.

The flexibility of **RATIO**, thanks to its multiple accessories, makes it easier to find what you need while keeping everything within reach while you cook.









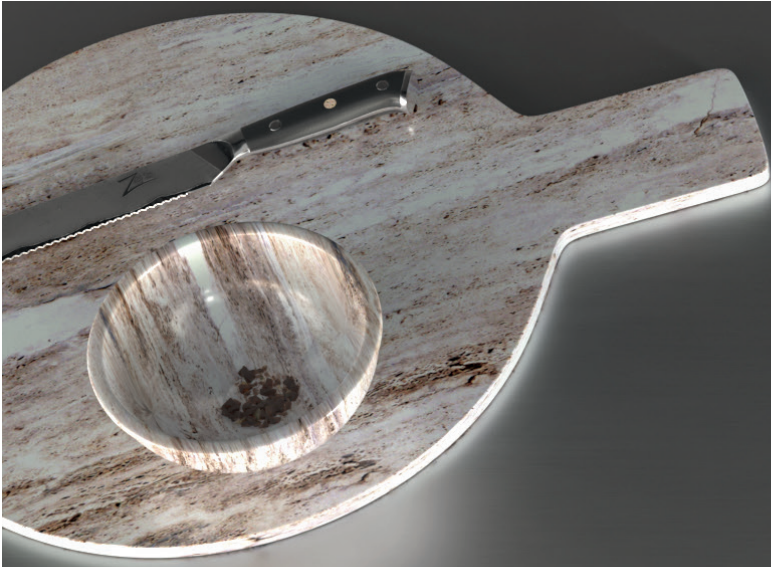



Il sistema **RATIO** è composto di accessori con finitura in alluminio anodizzato o un mix di alluminio e legno.

The **RATIO** system is composed of accessories with anodised aluminum finish or a mix of aluminum and wood.















## Interno cassetti Internal part of drawers

### TAPPETINO T12 (GRIGIO) E PORTAPOSATE DOPPIO PER CASSETTO DA 450 T12 MAT (GREY) AND DOUBLE CUTLERY TRAY FOR 450 DRAWER

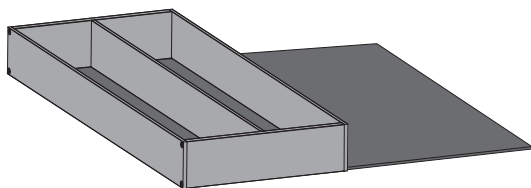

COLORE color	ALL. aluminium	CODICE code
■ Titanio Titanium	Anodizzato Anodized	08700342T
■ Silver Dark Dark Silver	Verniciato Painted	08700342SD

### TAPPETINO T12 (GRIGIO) E PORTAPOSATE DOPPIO PER CASSETTO DA 600 T12 MAT (GREY) AND DOUBLE CUTLERY TRAY FOR 600 DRAWER

COLORE color	ALL. aluminium	CODICE code
■ Titanio Titanium	Anodizzato Anodized	08700343T
■ Silver Dark Dark Silver	Verniciato Painted	08700343SD

### TAPPETINO T12 (GRIGIO) E PORTAPOSATE DOPPIO PER CASSETTO DA 750 T12 MAT (GREY) AND DOUBLE CUTLERY TRAY FOR 750 DRAWER

COLORE color	ALL. aluminium	CODICE code
■ Titanio Titanium	Anodizzato Anodized	08700344T
■ Silver Dark Dark Silver	Verniciato Painted	08700344SD

### TAPPETINO T12 (GRIGIO) E PORTAPOSATE DOPPIO PER CASSETTO DA 900 T12 MAT (GREY) AND DOUBLE CUTLERY TRAY FOR 900 DRAWER

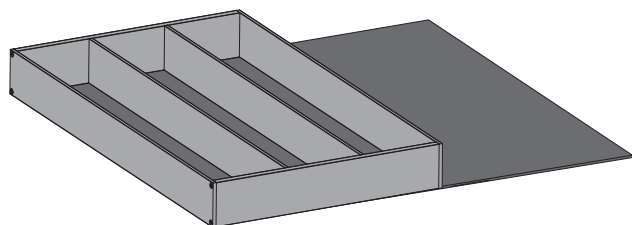

COLORE color	ALL. aluminium	CODICE code
■ Titanio Titanium	Anodizzato Anodized	08700346T
■ Silver Dark Dark Silver	Verniciato Painted	08700346SD

### TAPPETINO T12 (GRIGIO) E PORTAPOSATE DOPPIO PER CASSETTO DA 1200 T12 MAT (GREY) AND DOUBLE CUTLERY TRAY FOR 1200 DRAWER

COLORE color	ALL. aluminium	CODICE code
■ Titanio Titanium	Anodizzato Anodized	08700347T
■ Silver Dark Dark Silver	Verniciato Painted	08700347SD

### PORTAPOSATE DOPPIO H.50 L.184 P.470 DOUBLE CUTLERY TRAY H.50 W.184 D.470

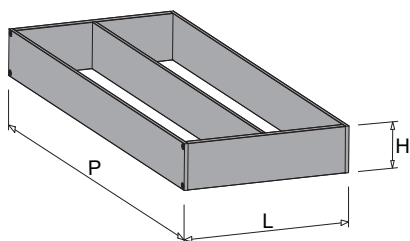

COLORE color	ALL. aluminium	CODICE code
■ Titanio Titanium	Anodizzato Anodized	08700350T
■ Silver Dark Dark Silver	Verniciato Painted	08700350SD

### PORTAPOSATE TRIPLO H.50 L.274 P.470 TRIPLE CUTLERY TRAY H.50 W.274 D.470

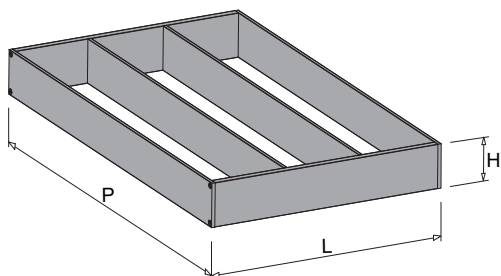

COLORE color	ALL. aluminium	CODICE code
■ Titanio Titanium	Anodizzato Anodized	08700351T
■ Silver Dark Dark Silver	Verniciato Painted	08700351SD

### TAPPETINO ANTISCIVOLO - GRIGIO NON-SLIP MAT-GREY

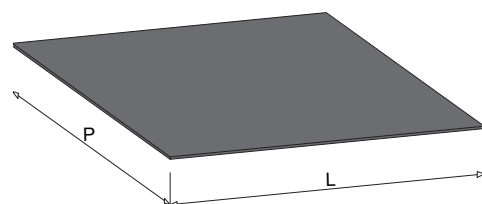

DIMENSIONI dimensions	CODICE code
■ mm. L.327 P.471 - cassetto drawer da 450	08700392
■ mm. L.477 P.471 - cassetto drawer da 600	08700393
■ mm. L.627 P.471 - cassetto drawer da 750	08700394
■ mm. L.777 P.471 - cassetto drawer da 900	08700395
■ mm. L.1077 P.471 - cassetto drawer da 1200	08700396

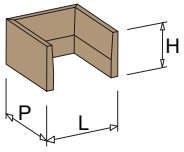

**DIVISORIO PORTAPOSATE SINGOLO LEGNO** H.50 L.85 P.85  
**SINGLE WOOD CUTLERY HOLDER DIVIDER** H.50 W.85 D.85

COLORE color	CODICE code
■ Legno scuro Dark wood	08700374LS

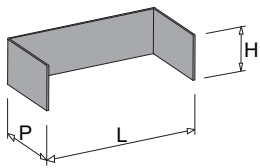

**DIVISORIO PORTAPOSATE DOPPIO ALLUMINIO** H.50 L.180 P.80  
**DOUBLE ALUMINUM CUTLERY HOLDER DIVIDER** H.50 W.180 D.80

COLORE color	ALL. aluminium	CODICE code
■ Titanio Titanium	Anodizzato Anodized	08700375T
■ Silver Dark Dark Silver	Verniciato Painted	08700375SD

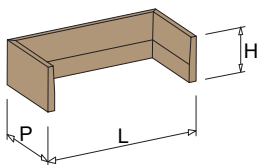

**DIVISORIO PORTAPOSATE DOPPIO LEGNO** H.50 L.175 P.85  
**DOUBLE WOOD CUTLERY HOLDER** H.50 W.175 D.85

COLORE color	CODICE code
■ Legno scuro Dark wood	08700375LS

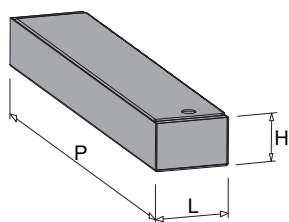

**PORTAFILM A STRAPPO SINGOLO** H.50 L.80 P.470\*  
SINGLE TEAR FILM HOLDER H.50 W.80 D.470\*

COLORE color	ALL. aluminium	CODICE code
■ Titanio Titanium	Anodizzato Anodized	08700370T
■ Silver Dark Dark Silver	Verniciato Painted	08700370SD

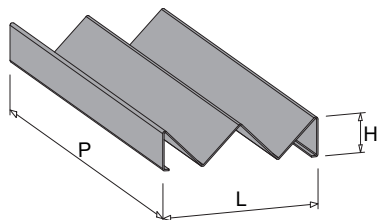

**PORTASPEZIE DOPPIO** H.50 L.180 P.470  
DOUBLE SPICE RACK H.50 W.180 D.470

COLORE color	ALL. aluminium	CODICE code
■ Titanio Titanium	Anodizzato Anodized	08700371T
■ Silver Dark Dark Silver	Verniciato Painted	08700371SD

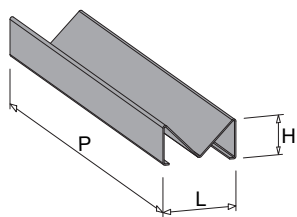

**PORTASPEZIE SINGOLO** H.50 L.80 P.470  
SINGLE SPICE RACK H.50 W.80 D.470

COLORE color	ALL. aluminium	CODICE code
■ Titanio Titanium	Anodizzato Anodized	08700372T
■ Silver Dark Dark Silver	Verniciato Painted	08700372SD

\*disponibile in una sola profondità  
\* available in one depth only

## Interno cassetti Internal part of drawers

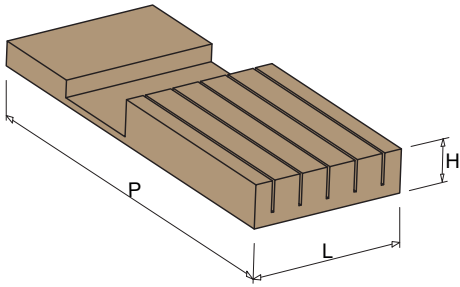

**PORTACOLTELLI** H.50 L.180 P.470\*  
KNIFE HOLDER H.50 L.180 D.470\*

COLORE color	CODICE code
<ul style="list-style-type: none"> <li>■ Legno scuro Dark wood</li> </ul>	08700373LS

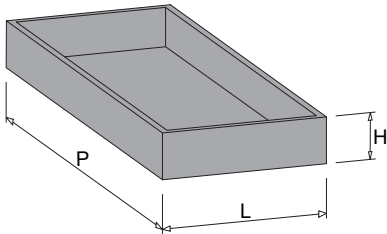

**VASSOIO ALLUMINIO** H.50 L.180 P.470  
ALUMINUM TRAY H.50 W.180 D.470

COLORE color	ALL. aluminium	CODICE code
<ul style="list-style-type: none"> <li>■ Titanio Titanium</li> <li>■ Silver Dark Dark Silver</li> </ul>	<ul style="list-style-type: none"> <li>Anodizzato Anodized</li> <li>Verniciato Painted</li> </ul>	<ul style="list-style-type: none"> <li>08700377T</li> <li>08700377SD</li> </ul>

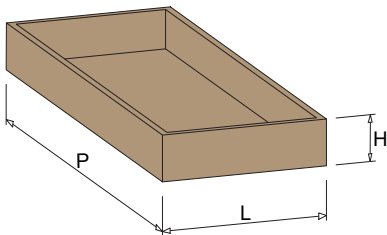

**VASSOIO LEGNO** H.50 L.180 P.470  
WOODEN TRAY H.50 L.180 D.470

COLORE	CODICE
<ul style="list-style-type: none"> <li>■ Legno scuro Dark wood</li> </ul>	08700377LS

\*disponibile in una sola profondità  
\* available in one depth only







## Cestoni Deep drawers

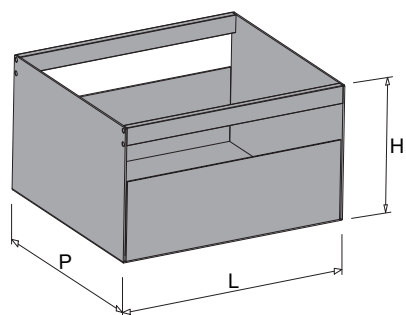

**CESTONE IN ALLUMINIO P 230** H.150 L.260 P.230  
ALUMINUM DEEP DRAWER D 230 H.150 W.260 D.230

COLORE color	ALL. aluminium	CODICE code
■ Titanio Titanium	Anodizzato Anodized	08700412T
■ Silver Dark Dark Silver	Verniciato Painted	08700412SD

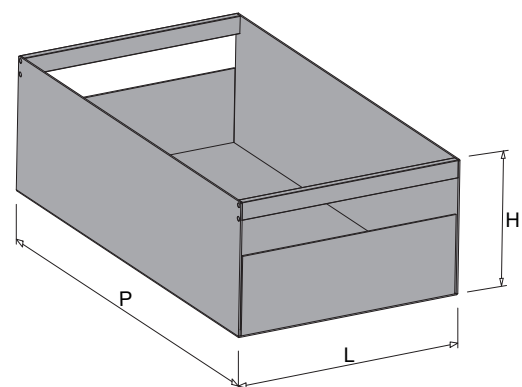

**CESTONE IN ALLUMINIO P 460** H.150 L.260 P.460  
ALUMINUM DEEP DRAWER D 460 H.150 W.260 D.460

COLORE color	ALL. aluminium	CODICE code
■ Titanio Titanium	Anodizzato Anodized	08700422T
■ Silver Dark Dark Silver	Verniciato Painted	08700422SD

## Cestoni Deep drawers

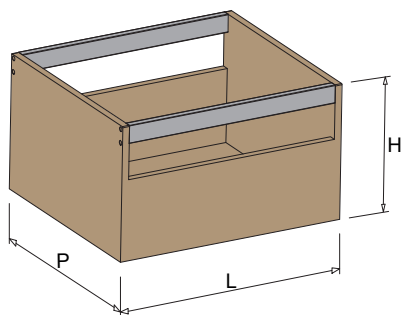

**CESTONE CON LEGNO P 230** H.150 L.260 P.230  
DEEP DRAWER WITH WOOD D 230 H.150 W.260 D.230

COLORE color	ALL. aluminium	CODICE code
■ ■ L. Scuro - Titanio L.Dark - Titanium	Anodizzato Anodized	08700412TS
■ ■ L. Scuro - S. Dark L.Dark - Dark Silver	Verniciato Painted	08700412SDS

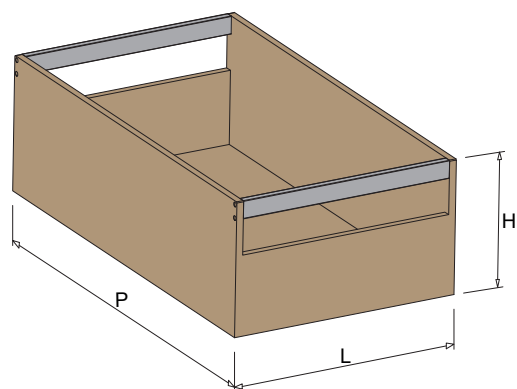

**CESTONE CON LEGNO P 460** H.150 L.260 P.460  
DEEP DRAWER WITH WOOD D 460 H.150 W.260 D.460

COLORE color	ALL. aluminium	CODICE code
■ ■ L. Scuro - Titanio L.Dark - Titanium	Anodizzato Anodized	08700422TS
■ ■ L. Scuro - S. Dark L.Dark - Dark Silver	Verniciato Painted	08700422SDS



---

# Esempi di composizioni per cassette

## Examples of compositions for drawers

---

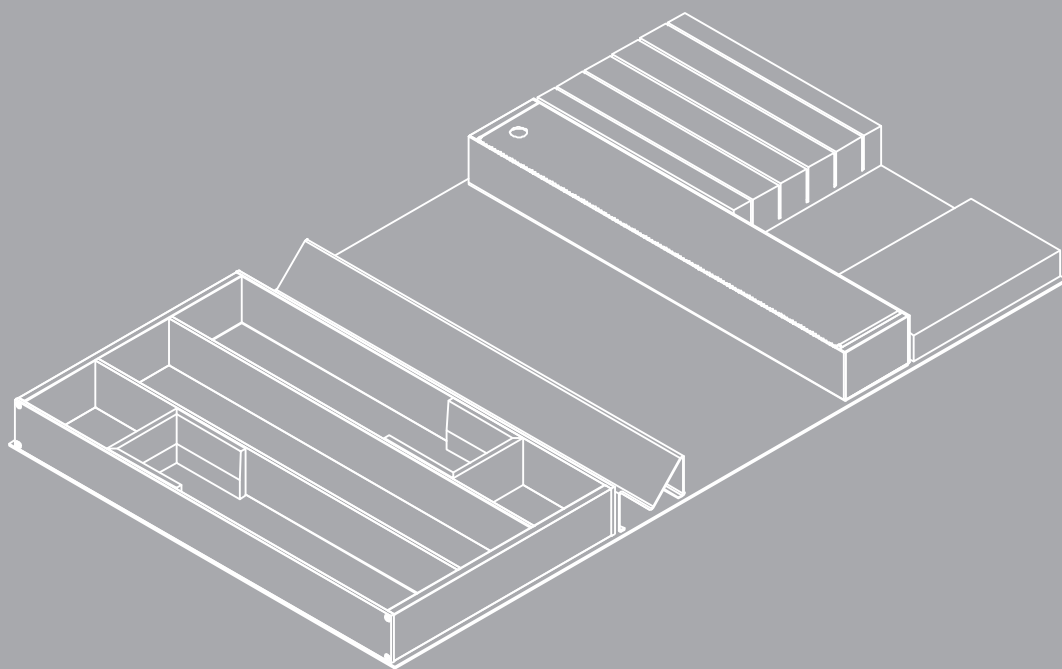

## Esempi di composizioni per cassetti da 450 mm

Examples of compositions for 450 mm drawers

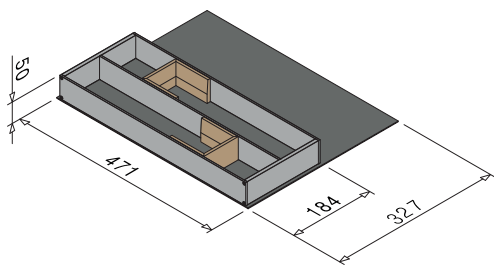

### ESEMPIO DI COMPOSIZIONE 01:

#### COMPOSITION EXAMPLE 01:

- PORTAPOSATE DOPPIO  
DOUBLE CUTLERY TRAY
- DIVISORIO SINGOLO LEGNO  
SINGLE WOODEN DIVIDER
- TAPPETINO  
MAT

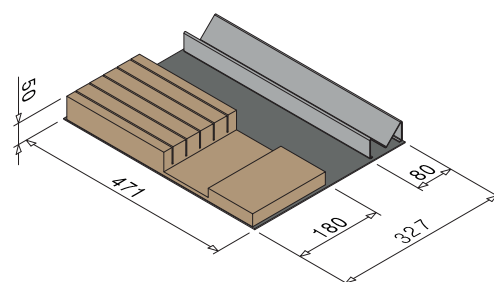

### ESEMPIO DI COMPOSIZIONE 02:

#### COMPOSITION EXAMPLE 02:

- PORTACOLTELLI  
KNIFE HOLDER
- PORTASPEZIE SINGOLO  
SINGLE SPICE RACK
- TAPPETINO  
MAT

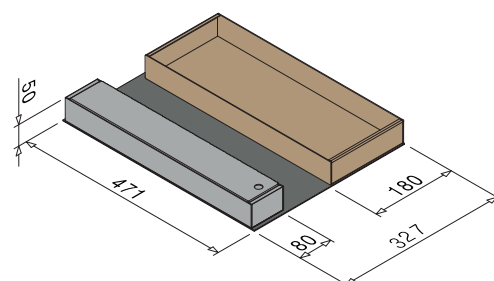

### ESEMPIO DI COMPOSIZIONE 03:

#### COMPOSITION EXAMPLE 03:

- PORTAFILM  
MOVIE HOLDER
- VASSOIO  
TRAY
- TAPPETINO  
MAT

## Esempi di composizioni per cassetti da 600 mm

Examples of compositions for 600 mm drawers

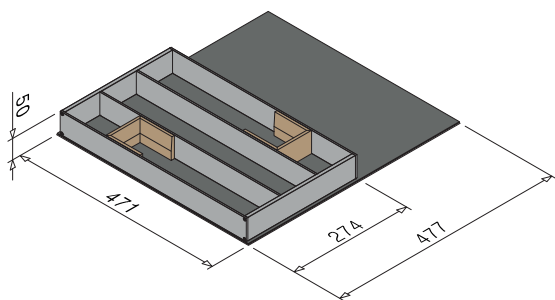

### ESEMPIO DI COMPOSIZIONE 01:

#### COMPOSITION EXAMPLE 01:

- PORTAPOSATE TRIPLO  
TRIPLE CUTLERY TRAY
- DIVISORIO SINGOLO LEGNO  
SINGLE WOODEN DIVIDER
- TAPPETINO  
MAT

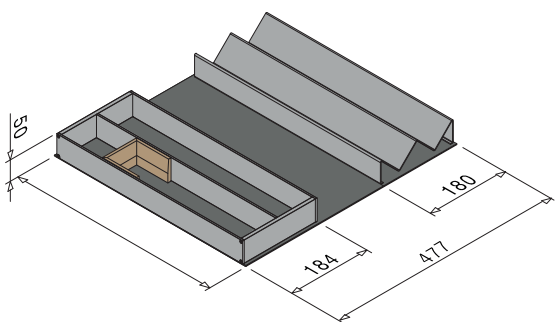

### ESEMPIO DI COMPOSIZIONE 02:

#### COMPOSITION EXAMPLE 02:

- PORTAPOSATE DOPPIO  
DOUBLE CUTLERY TRAY
- DIVISORIO SINGOLO LEGNO  
SINGLE WOODEN DIVIDER
- PORTASPEZIE DOPPIO  
DOUBLE SPICE RACK
- TAPPETINO  
MAT

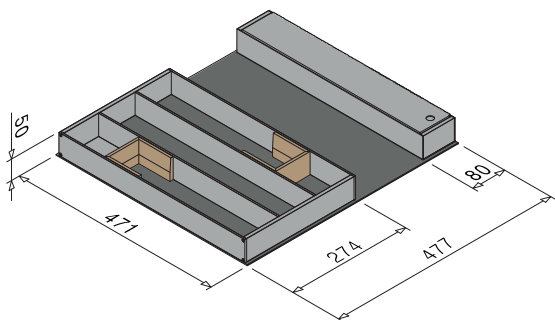

### ESEMPIO DI COMPOSIZIONE 03:

#### COMPOSITION EXAMPLE 03:

- PORTAPOSATE TRIPLO  
TRIPLE CUTLERY TRAY
- DIVISORIO SINGOLO LEGNO  
SINGLE WOODEN DIVIDER
- PORTAFILM  
FILM HOLDER
- TAPPETINO  
MAT

## Esempi di composizioni per cassetti da 900 mm

Examples of compositions for 900 mm drawers

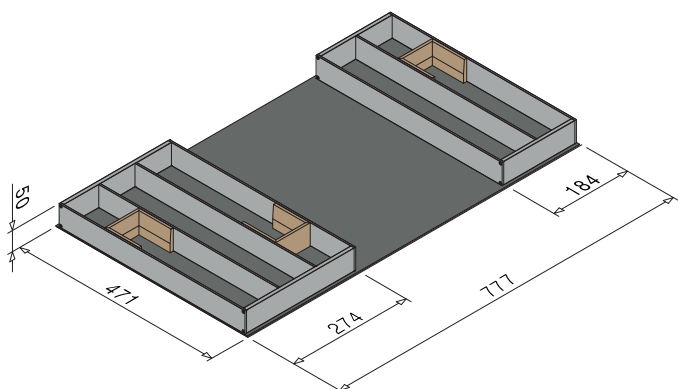

### ESEMPIO DI COMPOSIZIONE 01: COMPOSITION EXAMPLE 01:

- PORTAPOSATE TRIPLO  
TRIPLE CUTLERY TRAY
- PORTAPOSATE DOPPIO  
DOUBLE CUTLERY TRAY
- DIVISORIO SINGOLO LEGNO  
SINGLE WOODEN DIVIDER
- TAPPETINO  
MAT

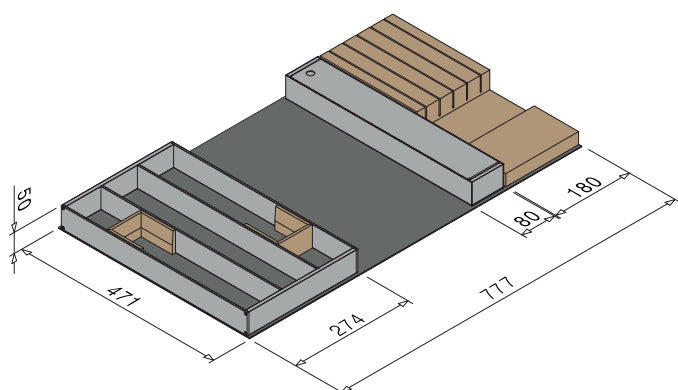

### ESEMPIO DI COMPOSIZIONE 02: COMPOSITION EXAMPLE 02:

- PORTAPOSATE TRIPLO  
TRIPLE CUTLERY TRAY
- DIVISORIO SINGOLO LEGNO  
SINGLE WOODEN DIVIDER
- PORTAFILM  
FILM HOLDER
- PORTACOLTELLI  
KNIFE HOLDER
- TAPPETINO  
MAT

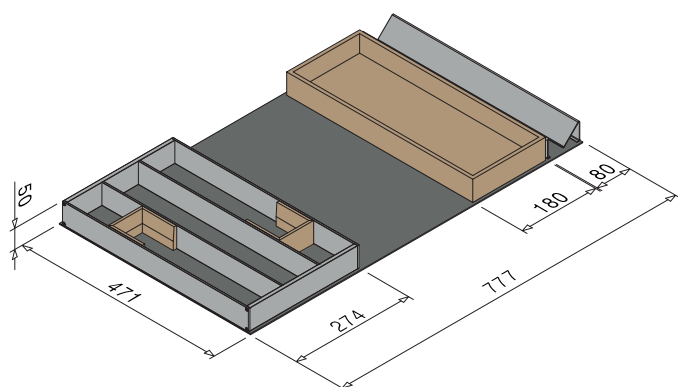

### ESEMPIO DI COMPOSIZIONE 03: COMPOSITION EXAMPLE 03:

- PORTAPOSATE TRIPLO  
TRIPLE CUTLERY TRAY
- DIVISORIO SINGOLO LEGNO  
SINGLE WOODEN DIVIDER
- VASSOIO  
TRAY
- PORTASPEZIE  
SPICE RACK
- TAPPETINO  
MAT

## Esempi di composizioni per cassetti da 1200 mm

Examples of compositions for 1200 mm drawers

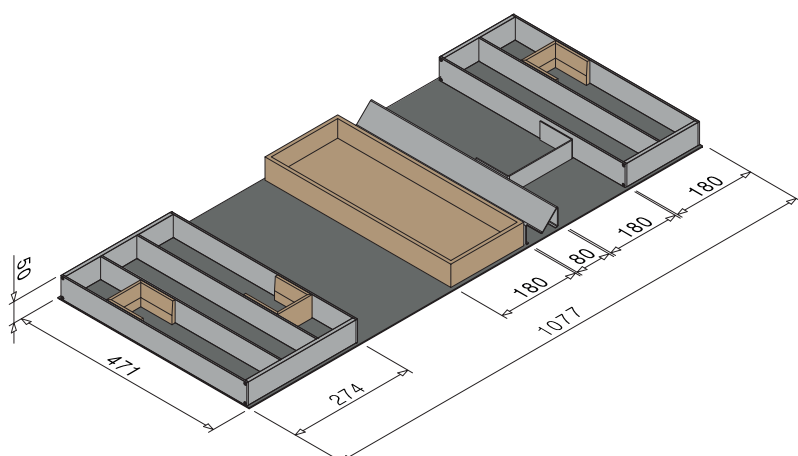

### ESEMPIO DI COMPOSIZIONE 01:

#### COMPOSITION EXAMPLE 01:

- PORTAPOSATE TRIPLO  
TRIPLE CUTLERY TRAY
- DIVISORIO SINGOLO LEGNO  
SINGLE WOODEN DIVIDER
- VASSOIO  
TRAY
- PORTASPEZIE SINGOLO  
SINGLE SPICE RACK
- DIVISORIO DOPPIO ALLUMINIO  
DOUBLE ALUMINUM DIVIDER
- PORTAPOSATE DOPPIO  
DOUBLE CUTLERY TRAY
- TAPPETINO  
MAT

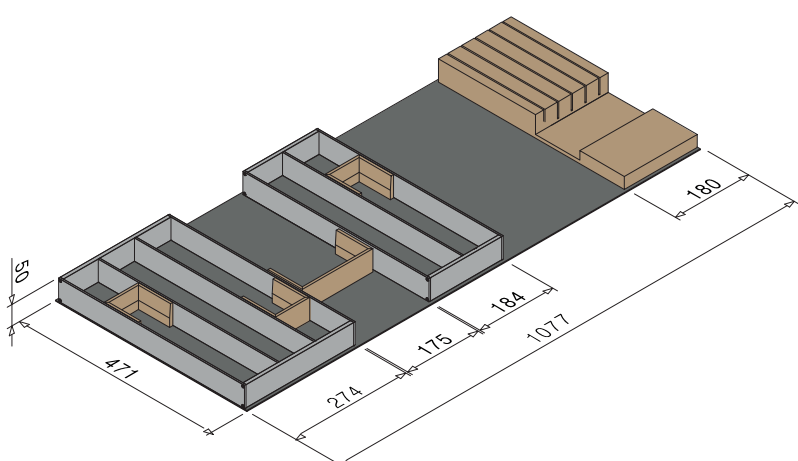

### ESEMPIO DI COMPOSIZIONE 02:

#### COMPOSITION EXAMPLE 02:

- PORTAPOSATE TRIPLO  
TRIPLE CUTLERY TRAY
- DIVISORIO SINGOLO LEGNO  
SINGLE WOODEN DIVIDER
- DIVISORIO DOPPIO LEGNO  
DOUBLE WOODEN DIVIDER
- PORTAPOSATE DOPPIO  
DOUBLE CUTLERY TRAY
- PORTACOLTELLI  
KNIFE HOLDER
- TAPPETINO  
MAT

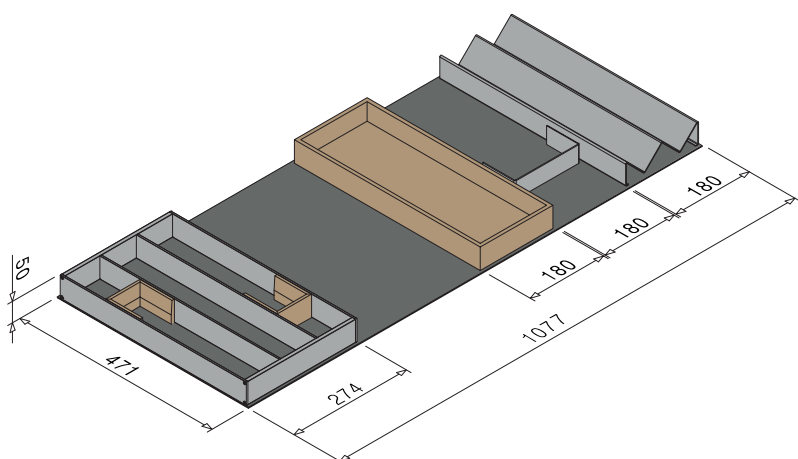

### ESEMPIO DI COMPOSIZIONE 03:

#### COMPOSITION EXAMPLE 03:

- PORTAPOSATE TRIPLO  
TRIPLE CUTLERY TRAY
- DIVISORIO SINGOLO LEGNO  
SINGLE WOODEN DIVIDER
- VASSOIO  
TRAY
- DIVISORIO DOPPIO ALLUMINIO  
DOUBLE ALUMINUM DIVIDER
- PORTASPEZIE DOPPIO  
DOUBLE SPICE RACK
- TAPPETINO  
MAT



GRUPPOLUBE



PORTAPOSATE 800

ACCESSORI PER CASSETTO 2023

## COME ORGANIZZARE E TENERE IN ORDINE I CASSETTI DELLA CUCINA

Riorganizzare i cassetti della cucina è un'operazione periodica, che ti permette di pulire a fondo gli spazi e ordinare i diversi utensili, per avere tutto a portata di mano (e di occhio!).

**Quante volte apri i cassetti della cucina e non trovi quello che cerchi?**

**Probabilmente è davvero ora di fare un pò d'ordine!**

**Prima di tutto, fare decluttering può servire per eliminare eventuali utensili che non usiamo mai, ma anche capire se sono nel posto giusto ed eventualmente decidere come cambiarne la disposizione nei diversi cassetti.**

**Il passo successivo è suddividere i cassetti per ottimizzare lo spazio e tenere tutto in ordine: l'ideale è utilizzare divisori che ti permettono la massima flessibilità, come il nuovo accessorio 800.**

## PIÙ SPAZIO

**La possibilità di utilizzare ogni millimetro utile, ti farà probabilmente scoprire di avere più spazio di quanto credessi: e così potrai avere davvero tutto a portata di mano, rendendo l'esperienza in cucina ancora più piacevole!**

## HOW TO ORGANIZE AND KEEP KITCHEN DRAWERS TIDY

Reorganizing the kitchen drawers is a periodic operation, which allows you to thoroughly clean the spaces and order the different ones utensils, to have everything at hand (and in sight!).

How many times do you open the kitchen drawers and can't find what you are looking for?

It's probably really time to tidy up a bit!





First of all, decluttering can be used to eliminate any tools that we never use, but also to understand if they are in the right place and eventually decide how to change the arrangement in the different drawers.

The next step is to divide the drawers to optimize space and keep everything in order: the ideal is to use dividers that allow you maximum flexibility, like the new 800 accessory.

## MORE SPACE

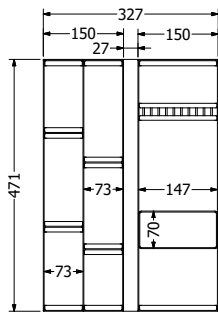
The possibility of using every useful millimeter will probably make you discover that you have more space than you thought: and so you can really have everything at your fingertips, making the cooking experience even more enjoyable!

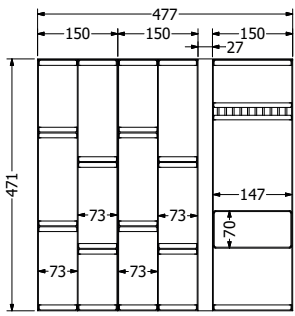
**PORTA POSATE IN ALLUMINIO ANODIZZATO ANTRACITE CON TAPPETINO GRIGIO ANTRACITE**  
**CUTLERY TRAY IN ANTHRACITE ANODIZED ALUMINUM WITH ANTHRACITE GRAY MAT**

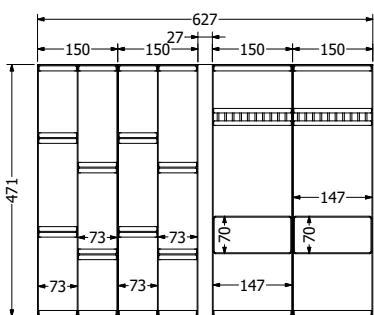
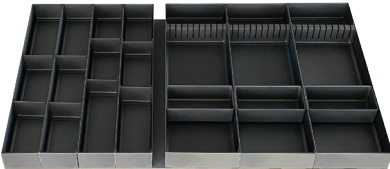
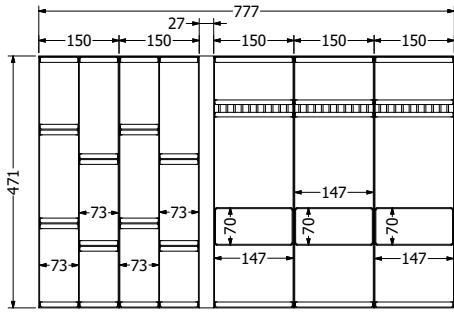
<p><b>Kit per cassetto antracite</b>      Drawer kit anthracite</p>   <p style="text-align: right;"><b>45</b></p>	<p><b>CODICE / CODE No.</b></p> <p style="text-align: center;"><b>08700192A</b></p>	
<p><b>Kit per cassetto antracite</b>      Drawer kit anthracite</p>   <p style="text-align: right;"><b>60</b></p>	<p><b>CODICE / CODE No.</b></p> <p style="text-align: center;"><b>08700194A</b></p>	
<p><b>Kit per cassetto antracite</b>      Drawer kit anthracite</p>   <p style="text-align: right;"><b>75</b></p>	<p><b>CODICE / CODE No.</b></p> <p style="text-align: center;"><b>08700196A</b></p>	
<p><b>Kit per cassetto antracite</b>      Drawer kit anthracite</p>   <p style="text-align: right;"><b>90</b></p>	<p><b>CODICE / CODE No.</b></p> <p style="text-align: center;"><b>08700197A</b></p>	

**PORTA POSATE IN ALLUMINIO ANODIZZATO ANTRACITE CON TAPPETINO GRIGIO ANTRACITE**  
**CUTLERY TRAY IN ANTHRACITE ANODIZED ALUMINUM WITH ANTHRACITE GRAY MAT**

**Kit per cassetto  
 antracite**

Drawer kit  
 anthracite

**CODICE / CODE No.**

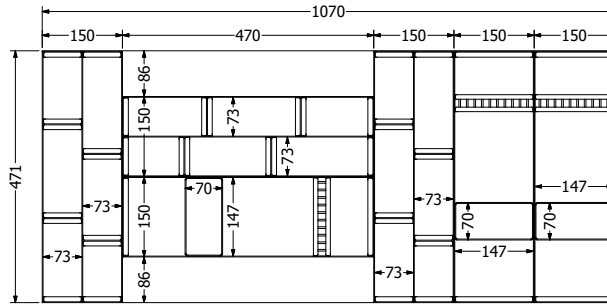

**120**

**08700198A**

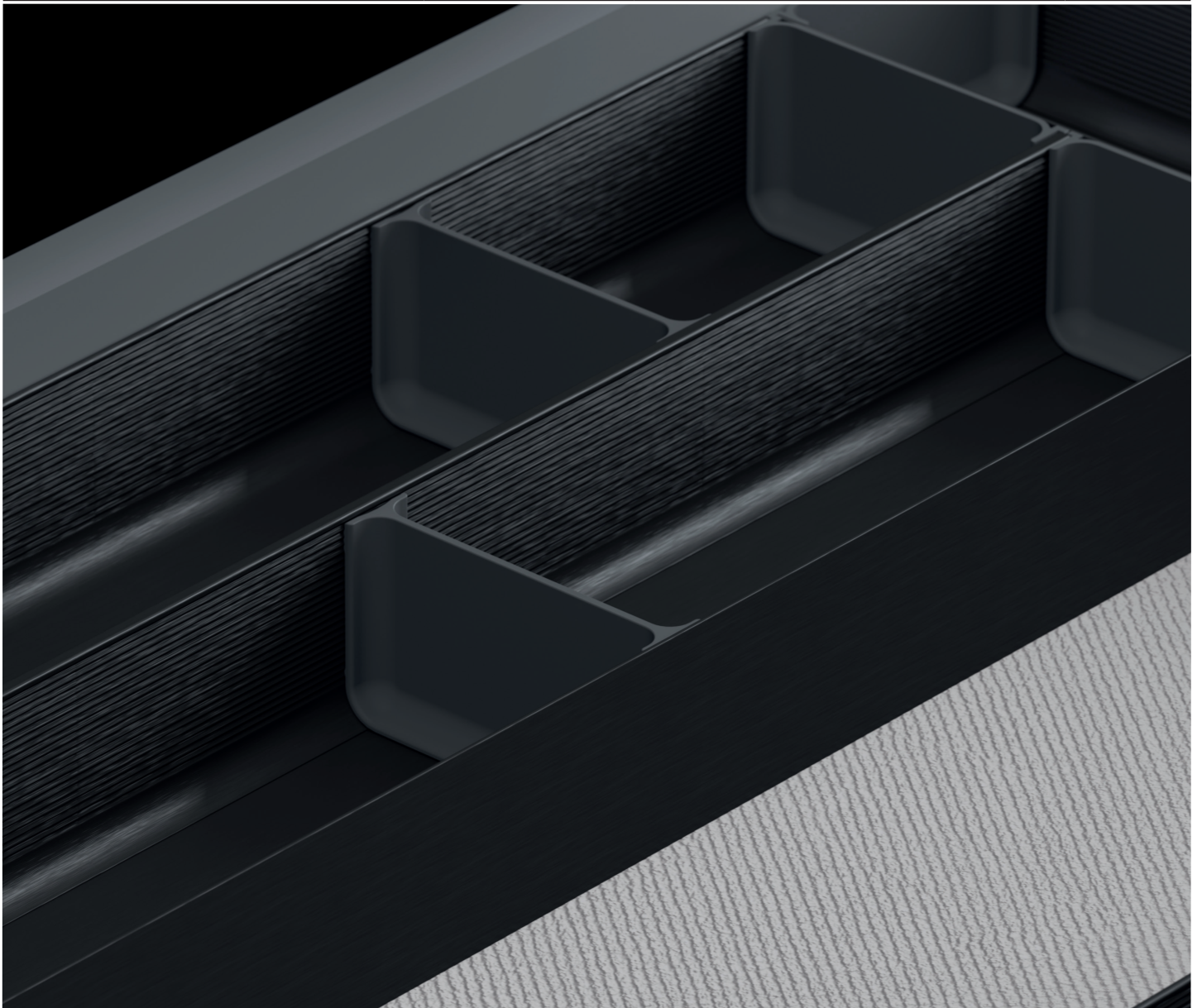

**PORTA POSATE IN ALLUMINIO ANODIZZATO ANTRACITE, CON TAPPETINO GRIGIO ANTRACITE**  
CUTLERY TRAY IN ANTHRACITE ANODIZED ALUMINIUM, WITH ANTHRACITE GRAY MAT

**SPECIFICHE E CARATTERISTICHE — SPECIFICATIONS AND FEATURES**

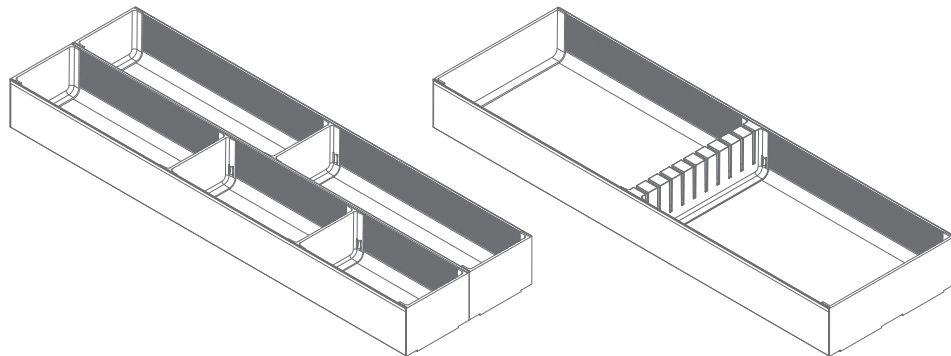

**DIMENSIONI — DIMENSIONS**

PROFILO PORTAPOSATE DOPPIO IN ALLUMINIO  
DOUBLE DRAWER DIVIDER IN ALUMINIUM

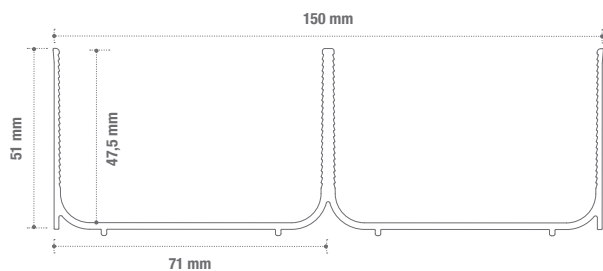

PROFILO PORTAPOSATE SINGOLO IN ALLUMINIO  
SINGLE DRAWER DIVIDER IN ALUMINIUM



GRUPPOLUBE



PORTAPOSATE BARLAN

ACCESSORI PER CASSETTO 2023

# ACCESSORI PER CASSETTI "BARLAN"

"BARLAN" ACCESSORIES FOR DRAWERS

## Portaposate per cassetto da 45 completo di tappetino

Cutlery tray for 45 drawer complete with mat

CODICE / CODE No.

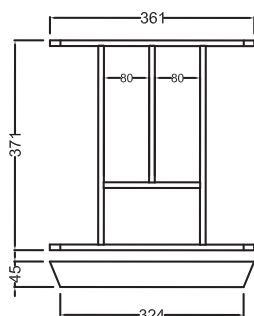
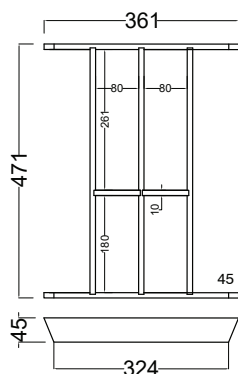

**Finitura** finish

**Orion Grau** orion grau per cassetto for drawer Prof.50

**Orion Grau** orion grau per cassetto for drawer Prof.40

08700611

08700621

## Portaposate per cassetto da 60 completo di tappetino

Cutlery tray for 60 drawer complete with mat

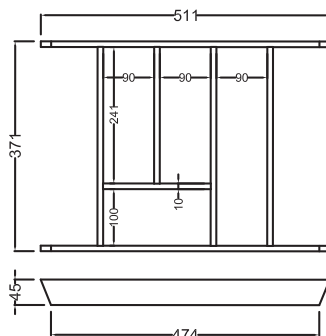
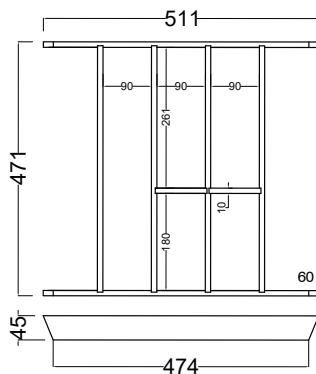
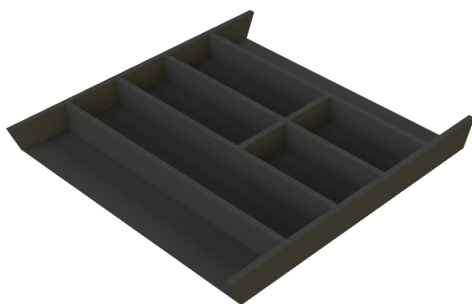

**Finitura** finish

**Orion Grau** orion grau per cassetto for drawer Prof.50

**Orion Grau** orion grau per cassetto for drawer Prof.40

08700612

08700622

# ACCESSORI PER CASSETTI "BARLAN"

"BARLAN" ACCESSORIES FOR DRAWERS

## Portaposate per cassetto da 75 completo di tappetino

Cutlery tray for 75 drawer complete with mat

CODICE / CODE No.

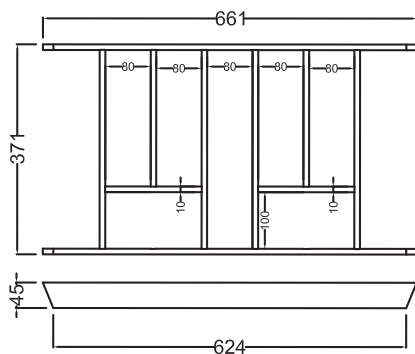
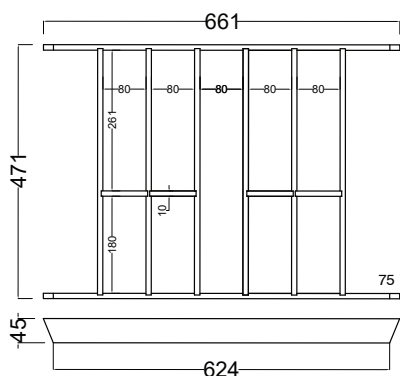
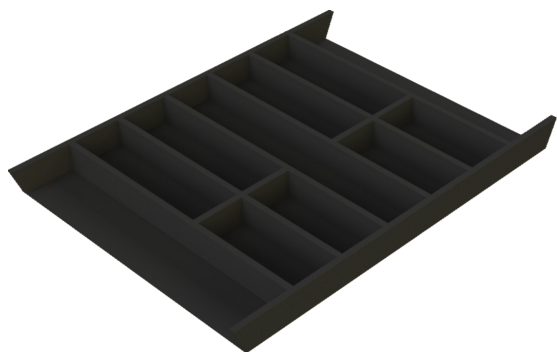

**Finitura finish**  
**Orion Grau** orion grau per cassetto for drawer Prof.50  
**Orion Grau** orion grau per cassetto for drawer Prof.40

08700613  
 08700623

## Portaposate per cassetto da 90 completo di tappetino

Cutlery tray for 90 drawer complete with mat

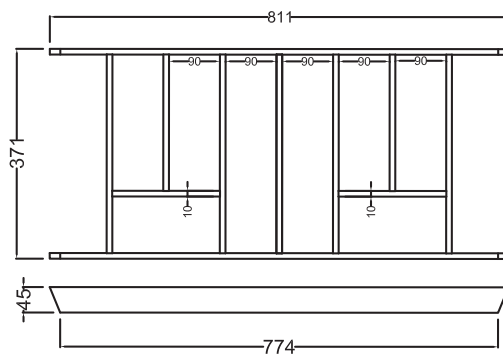
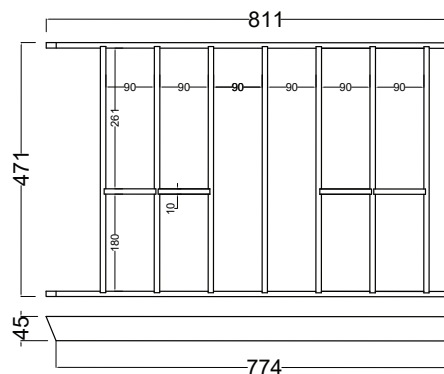
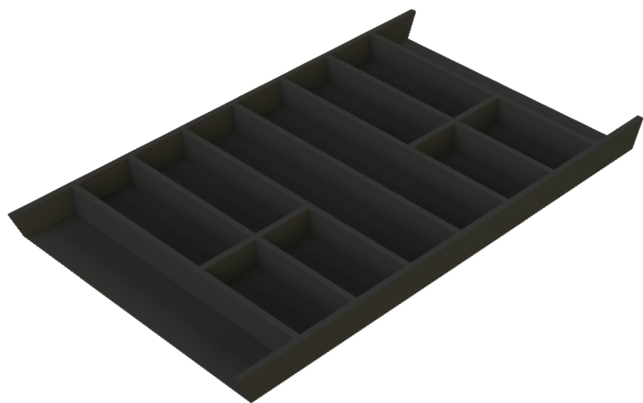

**Finitura finish**  
**Orion Grau** orion grau per cassetto for drawer Prof.50  
**Orion Grau** orion grau per cassetto for drawer Prof.40

08700614  
 08700624





GRUPPOLUBE



# PORTAPOSATE CUIBUS

ACCESSORI PER CASSETTO 2023

# MATERIALI

## *MATERIALS*

---

### **2 Materiali | *Materials***

4 Cuibus | *Cuibus*

18 Finiture | *Finishings*



ADATTO AL CONTATTO CON ALIMENTI  
SUITABLE FOR FOODSTUFF CONTACT



ANTI GRAFFIO  
RESISTANT TO SCRATCHES



RESISTENTE AD ACQUA E VAPORE  
RESISTANT TO WATER AND STEAM



ANTI IMPRONTE  
ANTI-FINGERPRINTS



RESISTENTE AI SOLVENTI  
RESISTANT TO ACID SOLVENTS



ECCELLENTI PROPRIETÀ IGIENICHE  
EXCELLENT HYGIENIC PROPERTIES

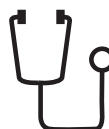

PROPRIETÀ ANTI BATTERICHE  
ANTI-BACTERIAL PROPERTIES



ANTISTATICO  
ANTISTATIC

*Un design semplice e iconico, e un uso di materiali d'avanguardia, sono le principali caratteristiche che rendono il sistema BelNet innovativo e pragmatico. La scelta dell'utilizzo del laminato compatto in spessore 4mm come materiale per la realizzazione degli accessori, è frutto di una ricerca accurata che ha avuto come punto di arrivo la selezione di un materiale resistente all'acqua, al vapore, facile da pulire, ma anche ad alta igienicità e con buone proprietà antibatteriche e antigraffio, tutte caratteristiche che rendono questo materiale perfetto se utilizzato al contatto con il cibo.*

A simple yet iconic design and the use of avant-garde materials are the features that make the BelNet system innovative and pragmatic. The choice to use compact laminate as the main component of our kitchen accessories is fruit of an extensive research aimed to find a material that not only is water and steam resistant, durable and easy to clean, but also a material with highly hygienic and antibacterial properties, that is at the same time scratch resistant and particularly apt to be in contact with food and moisture.



POSSIBILITÀ DI PERSONALIZZAZIONE  
POSSIBLE TO CUSTOMIZE



FACILE DA PULIRE  
EASY TO CLEAN

# CUIBUS

## *CUIBUS*

---

2 Materiali | *Materials*

**4 Cuibus | *Cuibus***

18 Finiture | *Finishings*









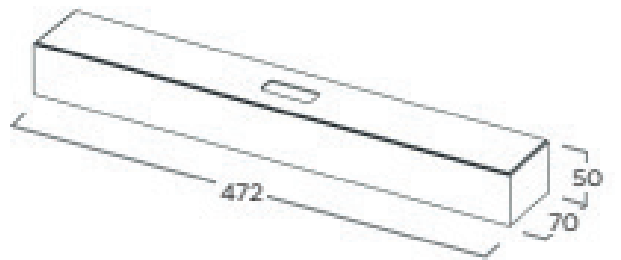
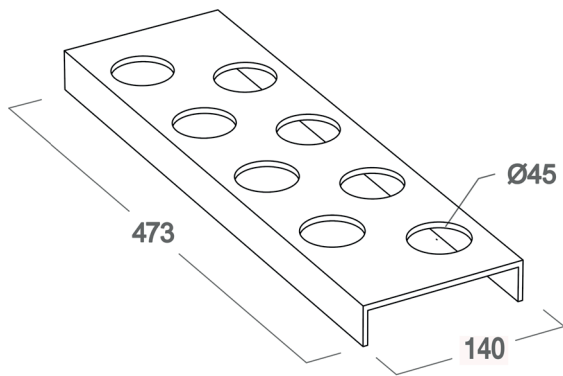
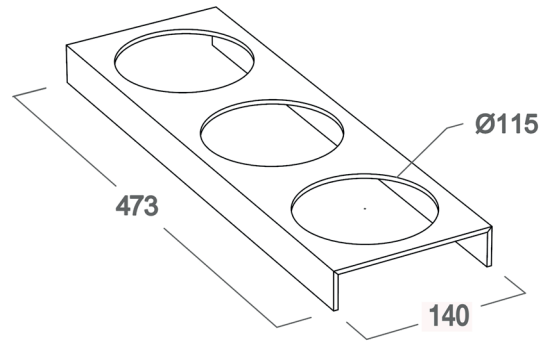
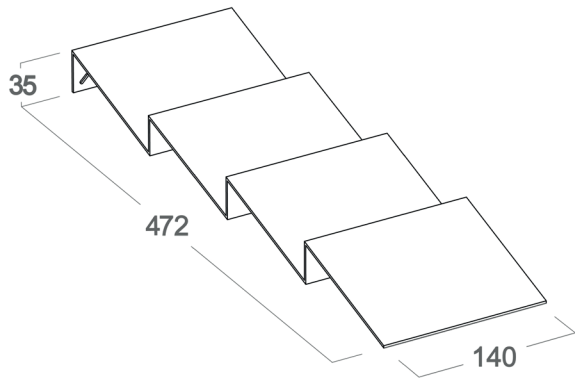

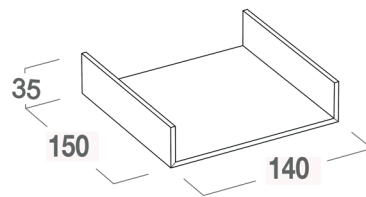
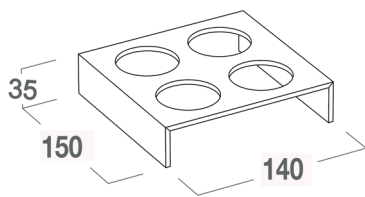
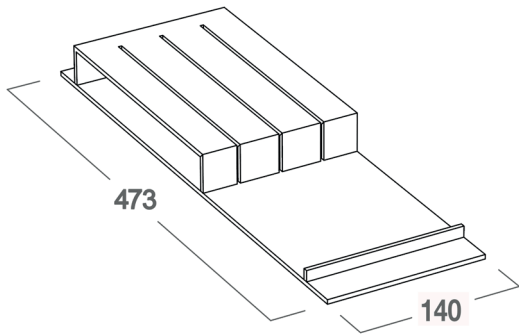

**GRIGLIA CUIBUS**  
*CUIBUS CUTLERY GRID*

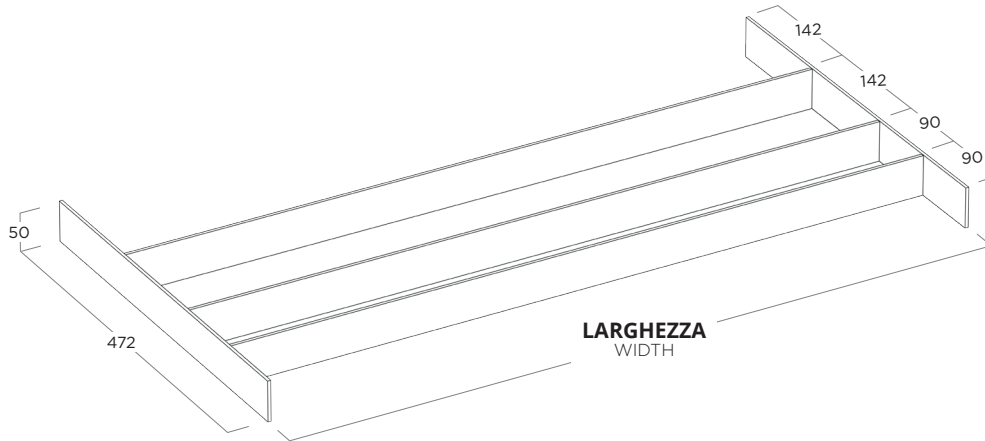

MODULO MODULE	LARGHEZZA (mm) WIDTH (mm)	PROFONDITÀ (mm) DEPTH (mm)	ALTEZZA (mm) HEIGHT (mm)
Module 600	521	472	50
Module 750	671	472	50
Module 900	821	472	50
Module 1200	1121	472	50

**FINITURE ALLUMINIO**  
*ALUMINIUM FINISHINGS*



**SILVER DARK**  
DARK SILVER

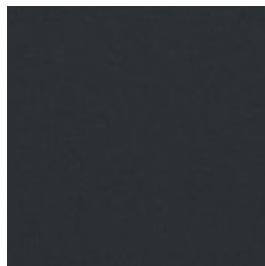

**GHISA**  
CAST IRON



**ALLUMINIO NERO**  
BLACK ALUMINIUM

**FINITURA LEGNO**  
*WOOD FINISHING*

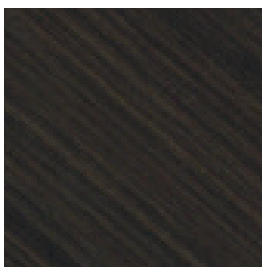

**OAK DARK BROWN**  
DARK BROWN OAK

## GRIGLIA OAK DARK BROWN+ ALLUMINIO GHISA

GRID DARK BROWN OAK + CAST IRON ALUMINIUM

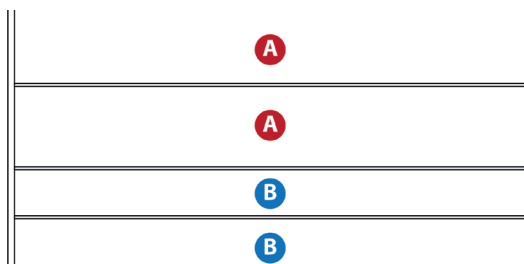
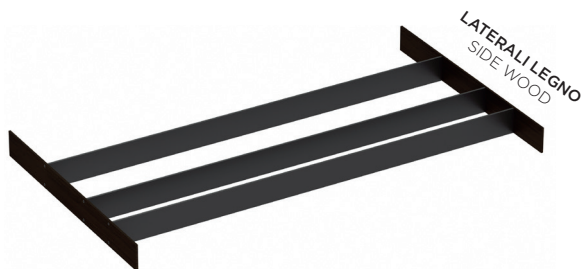

CODICE CODE	FINITURA FINISHING	MODULO (mm) MODULE (mm)	MISURE (mm) MEASURE (mm)
0865C1006G	Oak Dark Brown + Ghisa <i>Dark Brown Oak+ Cast Iron</i>	600	521 x 472 x 50
0865C1007G	Oak Dark Brown + Ghisa <i>Dark Brown Oak+ Cast Iron</i>	750	671 x 472 x 50
0865C1009G	Oak Dark Brown + Ghisa <i>Dark Brown Oak+ Cast Iron</i>	900	821 x 472 x 50
0865C1012G	Oak Dark Brown + Ghisa <i>Dark Brown Oak+ Cast Iron</i>	1200	1121 x 472 x 50



PORTA COLTELLI  
KNIVES RACK

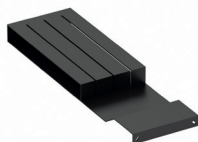

0865C0904G

PORTA BARATTOLI  
JARS HOLDER



0865C0907G

PORTA ROTOLI  
ROLLS HOLDER



0865C0909G

VASSOIO  
U TRAY

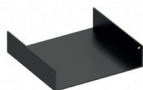

0865C0910G

PORTA OGGETTI  
OBJECT HOLDERS

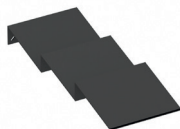

0865C0905G

PORTA SPEZIE  
SPICE JARS HOLDER



0865C0906G

PORTA SPEZIE  
SPICE RACK



0865C0911G



VASSOIO PICCOLO  
SMALL TRAY



0865C0912G

PORTA ROTOLI  
ROLLS HOLDER



0865C0909G

## GRIGLIA OAK DARK BROWN+ ALLUMINIO SILVER DARK

GRID DARK BROWN OAK + DARK SILVER ALUMINIUM

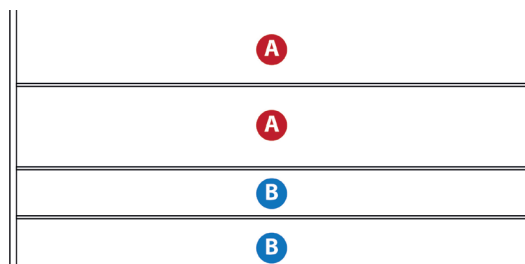
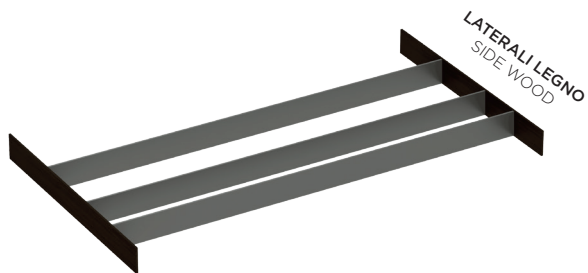

CODICE CODE	FINITURA FINISHING	MODULO (mm) MODULE (mm)	MISURE (mm) MEASURE (mm)
0865C1006S	Oak Dark Brown + Silver Dark <i>Dark Brown Oak+ Dark Silver</i>	600	521 x 472 x 50
0865C1007S	Oak Dark Brown + Silver Dark <i>Dark Brown Oak+ Dark Silver</i>	750	671 x 472 x 50
0865C1009S	Oak Dark Brown + Silver Dark <i>Dark Brown Oak+ Dark Silver</i>	900	821 x 472 x 50
0865C1012S	Oak Dark Brown + Silver Dark <i>Dark Brown Oak+ Dark Silver</i>	1200	1121 x 472 x 50



PORTA COLTELLI  
KRIVES RACK

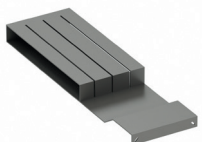

0865C0904S

PORTA BARATTOLI  
JARS HOLDER



0865C0907S

PORTA ROTOLI  
ROLLS HOLDER



0865C0909S

VASSOIO  
U TRAY

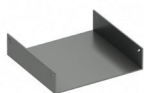

0865C0910S

PORTA OGGETTI  
OBJECT HOLDERS

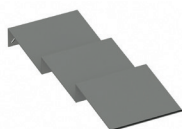

0865C0905S

PORTA SPEZIE  
SPICE JARS HOLDER



0865C0906S

PORTA SPEZIE  
SPICE RACK

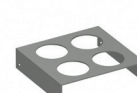

0865C0911S



VASSOIO PICCOLO  
SMALL TRAY

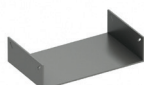

0865C0912S

PORTA ROTOLI  
ROLLS HOLDER



0865C0909S

## GRIGLIA OAK DARK BROWN+ ALLUMINIO NERO

GRID DARK BROWN OAK + BLACK ALUMINIUM

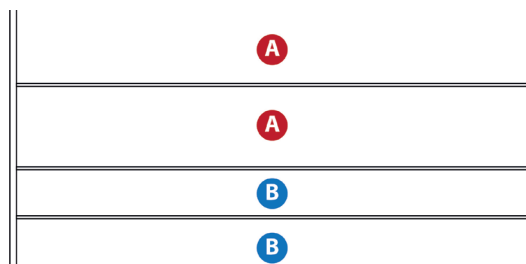
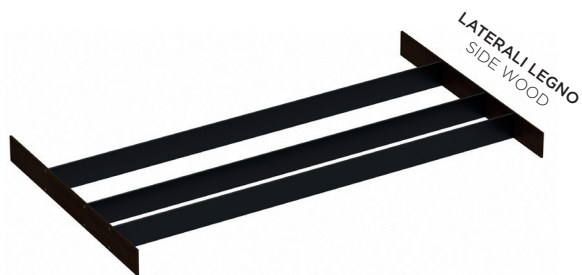

CODICE CODE	FINITURA FINISHING	MODULO (mm) MODULE (mm)	MISURE (mm) MEASURE (mm)
0865C1006N	Oak Dark Brown + Nero <i>Dark Brown Oak+ Black</i>	600	521 x 472 x 50
0865C1007N	Oak Dark Brown + Nero <i>Dark Brown Oak+ Black</i>	750	671 x 472 x 50
0865C1009N	Oak Dark Brown + Nero <i>Dark Brown Oak+ Black</i>	900	821 x 472 x 50
0865C1012N	Oak Dark Brown + Nero <i>Dark Brown Oak+ Black</i>	1200	1121 x 472 x 50



PORTA COLTELLI  
KNIVES RACK

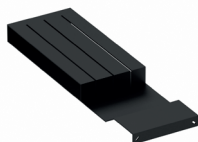

0865C0904N

PORTA BARATTOLI  
JARS HOLDER



0865C0907N

PORTA ROTOLI  
ROLLS HOLDER



0865C0909N

VASSOIO  
U TRAY



0865C0910N

PORTA OGGETTI  
OBJECT HOLDERS

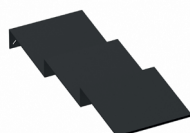

0865C0905N

PORTA SPEZIE  
SPICE JARS HOLDER



0865C0906N

PORTA SPEZIE  
SPICE RACK



0865C0911N



VASSOIO PICCOLO  
SMALL TRAY



0865C0912N

PORTA ROTOLI  
ROLLS HOLDER



0865C0909N







**GRIGLIA CUIBUS PER CESTONE**  
*CUIBUS CUTLERY GRID FOR HIGH DRAWER*

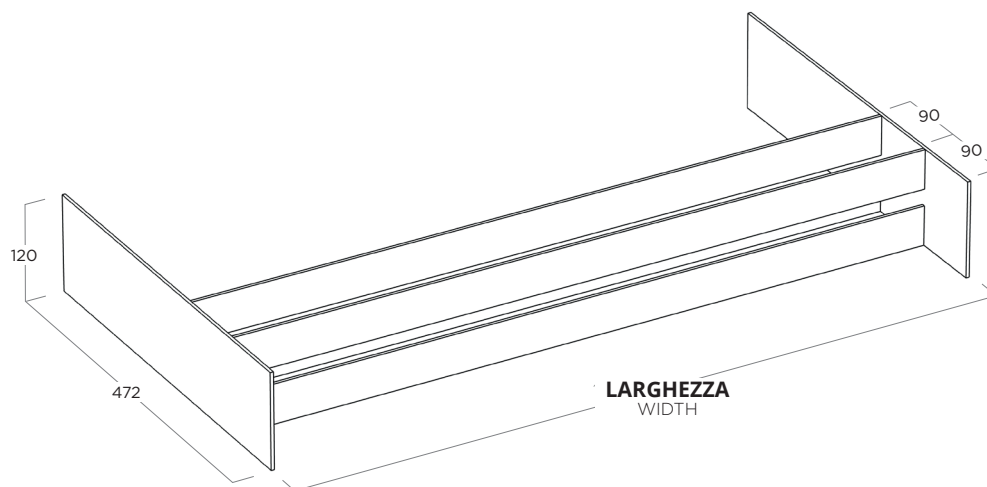

MODULO MODULE	LARGHEZZA (mm) WIDTH (mm)	PROFONDITÀ (mm) DEPTH (mm)	ALTEZZA (mm) HEIGHT (mm)
600	521	472	120
750	671	472	120
900	821	472	120
1200	1121	472	120

**FINITURE ALLUMINIO**  
*ALUMINIUM FINISHINGS*

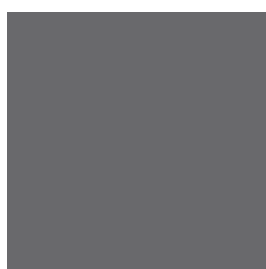

**SILVER DARK**  
 DARK SILVER

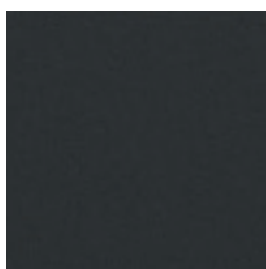

**GHISA**  
 CAST IRON



**ALLUMINIO NERO**  
 BLACK ALUMINIUM

**FINITURA LEGNO**  
*WOOD FINISHING*

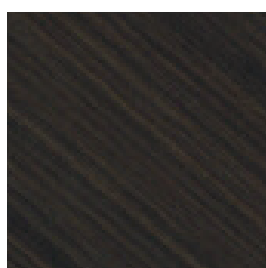

**OAK DARK BROWN**  
 DARK BROWN OAK

## GRIGLIA OAK DARK BROWN+ ALLUMINIO GHISA

GRID DARK BROWN OAK + CAST IRON ALUMINIUM

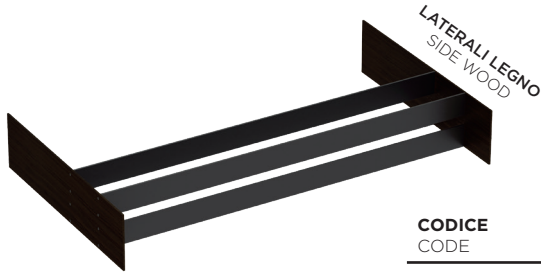

CODICE CODE	FINITURA FINISHING	MODULO (mm) MODULE (mm)	MISURE (mm) MEASURE (mm)
0865C1016G	Oak Dark Brown + Ghisa <i>Dark Brown Oak+ Cast Iron</i>	600	521 x 472 x 120
0865C1017G	Oak Dark Brown + Ghisa <i>Dark Brown Oak+ Cast Iron</i>	750	671 x 472 x 120
0865C1019G	Oak Dark Brown + Ghisa <i>Dark Brown Oak+ Cast Iron</i>	900	821 x 472 x 120
0865C1022G	Oak Dark Brown + Ghisa <i>Dark Brown Oak+ Cast Iron</i>	1200	1121 x 472 x 120

## GRIGLIA OAK DARK BROWN+ ALLUMINIO SILVER DARK

GRID DARK BROWN OAK + DARK SILVER ALUMINIUM

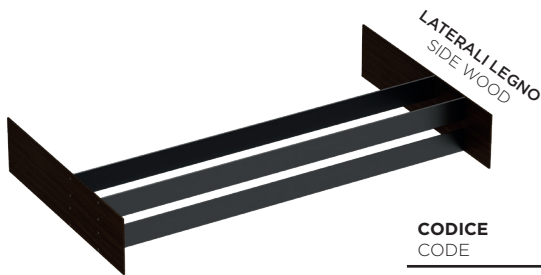

CODICE CODE	FINITURA FINISHING	MODULO (mm) MODULE (mm)	MISURE (mm) MEASURE (mm)
0865C1016S	Oak Dark Brown + Silver Dark <i>Dark Brown Oak+ Dark Silver</i>	600	521 x 472 x 120
0865C1017S	Oak Dark Brown + Silver Dark <i>Dark Brown Oak+ Dark Silver</i>	750	671 x 472 x 120
0865C1019S	Oak Dark Brown + Silver Dark <i>Dark Brown Oak+ Dark Silver</i>	900	821 x 472 x 120
0865C1022S	Oak Dark Brown + Silver Dark <i>Dark Brown Oak+ Dark Silver</i>	1200	1121 x 472 x 120

## GRIGLIA OAK DARK BROWN+ ALLUMINIO NERO

GRID DARK BROWN OAK + BLACK ALUMINIUM

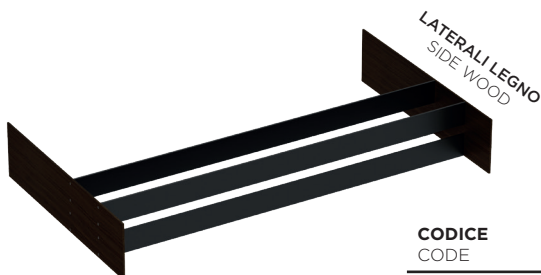

CODICE CODE	FINITURA FINISHING	MODULO (mm) MODULE (mm)	MISURE (mm) MEASURE (mm)
0865C1016N	Oak Dark Brown + Nero <i>Dark Brown Oak+ Black</i>	600	521 x 472 x 120
0865C1017N	Oak Dark Brown + Nero <i>Dark Brown Oak+ Black</i>	750	671 x 472 x 120
0865C1019N	Oak Dark Brown + Nero <i>Dark Brown Oak+ Black</i>	900	821 x 472 x 120
0865C1022N	Oak Dark Brown + Nero <i>Dark Brown Oak+ Black</i>	1200	1121 x 472 x 120

# FINITURE

## *FINISHINGS*

---

2 Materiali | *Materials*

4 Cuibus | *Cuibus*

**18 Finiture | *Finishings***

*\* Gli esempi di colore e materiale hanno valore indicativo.*

*\* The color and material references in this page are only indicative.*

## LEGNI IMPIALLACCIATI SU STRATIFICATO

*VENEERED WOOD ON COMPACT HPL*

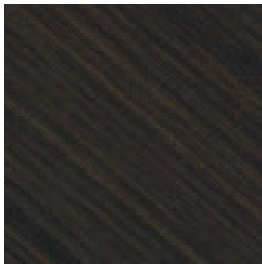

**OAK DARK BROWN**  
DARK BROWN OAK

## ALLUMINIO

*ALUMINIUM*



**SILVER DARK**  
DARK SILVER

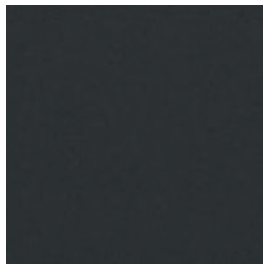

**GHISA**  
CAST IRON



**ALLUMINIO NERO**  
BLACK ALUMINIUM

# portaposate vuoti

## empty cutlery tray



### 75.37X

cassetto da 30.

In faggio listellato scavato 4 vani

30 cm drawer

With 4 grooves, made of beech wood strips.

prof. 500 (208x472) cod. 08707537X



### 75.36X

modulo 300 mm. / cassetto da 40

In faggio listellato scavato 6 vani

300 mm drawer/40 cm drawer

With 6 grooves, made of beech wood strips.

prof. 500 (300x472) cod. 08707536X  
Depth



### 75.38X

cassetto da 45.

In faggio listellato scavato 6 vani

45 cm drawer

With 6 grooves, made of beech wood strips.

prof. 500 (358x472) cod. 08707538X  
Depth



### 75.39X

cassetto da 60.

In faggio listellato scavato 7 vani

60 cm drawer

With 7 grooves, made of beech wood strips.

prof. 500 (508x472) cod. 08707539X  
Depth



### 75.3936X

cassetto da 90.

In faggio listellato scavato 12 vani

90 cm drawer

With 12 grooves, made of beech wood strips.

prof. 500 (808x472) cod. 08707540X  
Depth



# portaposate e contenitori cassetto da 90 cutlery tray and jars for 90 cm drawer



---

## 76.22X

Portaposate intero da 90 - tipo B  
(5 portaspezie + 3 scatole quadrate)

Cutlery tray for 90 cm drawer-type B  
(5 spice jars + 3 porcelain jars)

prof. 500 (808x472)    cod. 08707622X  
Depth



---

## 76.23X

Portaposate intero da 90 - tipo C  
(5 portaspezie + 2 tagliapellicola)

Cutlery tray for 90 cm drawer-type C  
(5 spice jars + 2 foil cutter)

prof. 500 (808x472)    cod. 08707623X  
Depth



---

## 75.43X

Portapadelle e coperchi per cestone da cm 60

Pan and lid rack for deep drawer cm 60

prof. 500 (508x472)    cod. 08708040X  
Depth

---

## 75.44X

Portapadelle e coperchi per cestone da cm 90

Pan and lid rack for deep drawer cm 90

prof. 500 (808x472)    cod. 08708042X  
Depth

---

GRUPPOLUBE



PORTAPOSATE IN PLASTICA

ACCESSORI PER CASSETTO 2023

# ACCESSORI PER CASSETTI

ACCESSORIES FOR DRAWERS



**Portaposate in plastica per cassetto 30**  
Plastic cutlery canteen for 30 cm drawer

**CODICE / CODE No.**

L 30 P 50

08700030X



**Portaposate in plastica per cassetto 40**  
Plastic cutlery canteen for 40 cm drawer

L 40 P 50

08700040X



**Portaposate in plastica per cassetto 45**  
Plastic cutlery canteen for 45 cm drawer

L 45 P 50

08700050X



**Portaposate in plastica per cassetto 60**  
Plastic cutlery canteen for 60 cm drawer

L 60 P 50

08700060X



**Portaposate in plastica per cassetto 75**  
Plastic cutlery canteen for 75 cm drawer

L 75 P 50

08700061X



# ACCESSORI PER CASSETTI

ACCESSORIES FOR DRAWERS



**Portaposate in plastica con divisori regolabili  
(a richiesta)**  
Plastic cutlery canteen with adjustable dividers  
(on request)

**CODICE / CODE No.**

L 45 P 50

08700065X



**Portaposate in plastica con divisori regolabili  
(a richiesta)**  
Plastic cutlery canteen with adjustable dividers  
(on request)

L 60 P 50

08700068X



**Portaposate in plastica con divisori regolabili  
(a richiesta)**  
Plastic cutlery canteen with adjustable dividers  
(on request)

L 90 P 50

08700070X



**Portaposate in plastica con divisori regolabili  
(a richiesta)**  
Plastic cutlery canteen with adjustable dividers  
(on request)

L 120 P 50

08700075X



Certificato numero / Certificate number: **RPP200061**

## CERTIFICATO DI CONFORMITÀ CERTIFICATE OF CONFORMITY

Si certifica che i prodotti di seguito indicati realizzati da / we hereby certify that the following products manufactured by

### FRIULANA ACCESSORI s.r.l.

Sede legale e Unità operativa di / Registered office and Place of business

**Via Colloredo, 120/124 – 33037 PASIAN DI PRATO (UD) – Italia**

sono conformi a / are in compliance with:

### RECYCLED PLASTIC Regole Particolari CSI (Doc.002/13) Annex C

Per i seguenti prodotti – Concerning the following products:

**Contenitori per la raccolta differenziata di rifiuti domestici e porta posate (Linea Horizon e Linea Composit) in polipropilene (PP) riciclato realizzati con la percentuale minima del 50% derivante da residui industriali e/o rifiuti pre-consumo (PIR)**

**Recycled polypropylene (PP) bins for separate collection of household waste and cutlery tray (Horizon and Composit) obtained from industrial scraps and/or pre-industrial waste (PIR) in the minimum quantity of 50%**

L'azienda è autorizzata ad utilizzare il marchio CSI PLASTICA RICICLATA secondo quanto disposto dalle regole particolari Doc. 002/13 / The organization is licensed to use the CSI RECYCLED PLASTIC mark according to specific rules Doc. 002/13



Il presente attestato è soggetto al rispetto del Regolamento generale per la concessione ed il mantenimento della certificazione volontaria di prodotti, processi e servizi (Doc.001/04) e delle regole particolari (Doc.002/13).  
Le risultanze dell'attività di valutazione eseguite sono contenute nel rapporto di verifica. La validità del presente attestato è subordinata a verifica triennale.

This attestation is subject to the compliance with CSI general rules and regulations for the issuance and maintenance of voluntary certification of products, processes and services (Doc.001/04) and with specific rules for the certification of recycled plastics and recycled plastic products (Doc.002/13).  
Evidence of the evaluation activity carried out are indicated in the audit report. The validity of this attestation is subjected to three years reaudit.

**09/03/2020**

Rilascio  
Issued

**09/03/2023**

Rinnovo  
Renewal

-----  
Aggiornamento  
Update

**08/03/2026**

Scadenza  
Expiry

Ing. P. Fumagalli  
B. A. Product

pag. 1/1

GQ002 REV.00

CSI S.p.A. A SOCIO UNICO  
SOGGETTA AD ATTIVITÀ DI DIREZIONE E  
COORDINAMENTO DI IMQ GROUP S.R.L.

REA MI 1466310  
R.I./C.F./P.I. 11360160151  
Cap. Soc. € 1.040.000

Sede legale  
Italia | 20030 Senago (MI) | Cascina Traversagna 21  
direzione-csi@legalmail.it | info@csi-spa.com | www.csi-spa.com

GRUPPOLUBE



SERVO-DRIVE/ORGA-LINE

ACCESSORI PER CASSETTO 2023

**SERVO-DRIVE UNO È AFFIDABILE - IN OGNI SITUAZIONE**

"SERVO-DRIVE UNO" IS RELIABLE - IN EVERY SITUATION

*Mani occupate?*

L'extra  
per il vostro  
cassettoni  
portarifiuti

A plus  
for your waste  
bin pull-outs

*.....nessun problema, basta  
un semplice tocco.*

# SERVO-DRIVE uno è affidabile – in ogni situazione

## SERVO-DRIVE one is reliable - in any situation



**Appoggiarsi? Naturalmente in tutta sicurezza.**

Grazie alla protezione in caso di appoggio integrata viene impedita l'apertura involontaria. Così potete restare completamente tranquilli. Per la pulizia dei frontali è possibile disattivare SERVO-DRIVE con una presa con interruttore.

**You can relax in your kitchen**

SERVO-DRIVE uno has an integrated feature that prevents unintentional opening. And when cleaning the fronts, SERVO-DRIVE can be deactivated via a switched outlet.



**Restio ad aprirsi? Solo quando serve.**

Il sensibile rilevamento delle collisioni reagisce in modo affidabile: all'occorrenza l'apertura viene immediatamente interrotta.

**Safety is assured**

The sensitive collision detection feature reacts reliably: The opening sequence is immediately interrupted when an obstruction is detected.



**Consumo di corrente? Non vale la pena parlarne.**

SERVO-DRIVE uno regala soddisfazioni anche per quanto riguarda il consumo di corrente, dato che il consumo in stand-by di 3,5 kWh all'anno è estremamente ridotto.

**Power consumption is negligible**

SERVO-DRIVE uno power consumption is a joy to behold-because standby consumption is very minimal (only 3,5 kWh per year)



**Requisiti? Facilmente soddisfabili.**

Tutto ciò che vi serve è un cassettono con accessori Blum ( con 41 mm di spazio a disposizione dietro lo schienale del cassettono) e una presa.

**Simple to install**

All you need is a Blum pull-out (with 41 mm space requirement behind pull-out back) and a power outlet.



# MONTAGGIO SEMPLICE EASY ASSEMBLY



- 1. Montare i respingenti Blum  
(in alternativa sostituire sul frontale  
i paracolpi fissi con quelli con respingente).**

Attaching the Blum distance bumpers  
(as an alternative replace the fixed buffers  
on the front door with the ones equipped with distance bumpers).



- 2. Posizionare l'ausilio di montaggio.**  
Place the assembly device.



- 3. Inserire l'unità SERVO-DRIVE.**  
Insert the SERVO-DRIVE unit.



- 4. Agganciare e chiudere il cassettone.**  
Connect and close the pull-out.

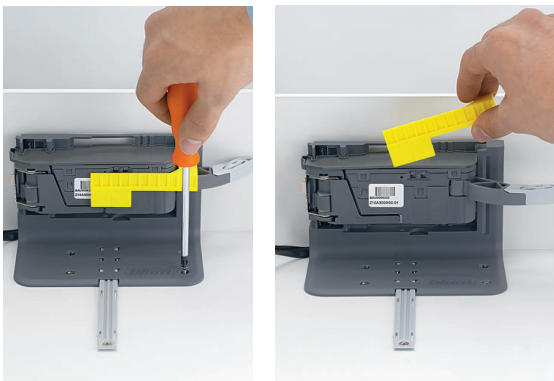

- 5. Avvitare l'unità SERVO-DRIVE e rimuovere la  
protezione per il trasporto.**

Screw the SERVO-DRIVE unit and remove the  
transportation lock.



- 6. Collegare SERVO-DRIVE uno alla presa di corrente.**  
Connect SERVO-DRIVE uno to the socket.



## SERVO-DRIVE uno per soluzioni con portarifiuti for bottom mount waste bin solutions

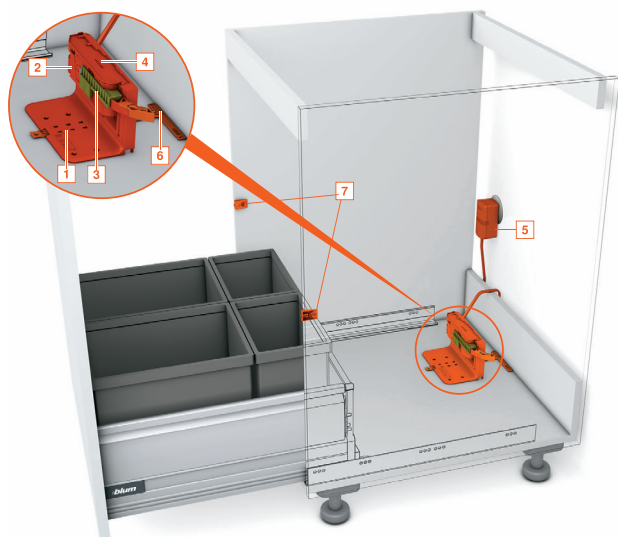

i	Contenuto
1	Supporto a squadra
2	Unità motrice
3	Protezione per il trasporto
4	Protezione da gocce d'acqua
5	Trasformatore Blum cavo incluso
6	Ausilio di montaggio
7	Respingente Blum

i	Contents
1	Attachment bracket
2	Drive unit
3	Transport protection
4	Protection against dripping water
5	Blum power supply, cable included
6	Blum assembly device
7	Blum distance bumpers

### L'extra per il cassettone portarifiuti

SERVO-DRIVE uno assicura un comfort elevato durante l'apertura delle soluzioni con portarifiuti d'appoggio. Il montaggio del singolo set premontato avviene con poche operazioni, senza richiedere ulteriori misurazioni o forature. Ideale anche per attrezzaggi successivi!

### a plus for waste pull-outs

SERVO-DRIVE uno ensures a high level of comfort during the opening of the bottom mount waste bin solutions. The installation of pre-assembled single set takes just a few steps, without requiring additional measurements or drillings. Also ideal for later toolings!

## SERVO-DRIVE uno

codice/code	prezzo/prices
5615710	

*N.B.: i prezzi sono espressi all'unità di euro (iva esclusa).  
I colori delle immagini riportate nel presente listino sono solamente  
indicativi e non possono essere utilizzati come riferimento.*

Note: prices are expressed in units of euro (vat excluded)  
The colours in the pictures appearing in this price list are purely indicative and  
should not be used for reference.



# AIUTI IN CUCINA ORGA-LINE

ORGA-LINE KITCHEN ACCESSORIES

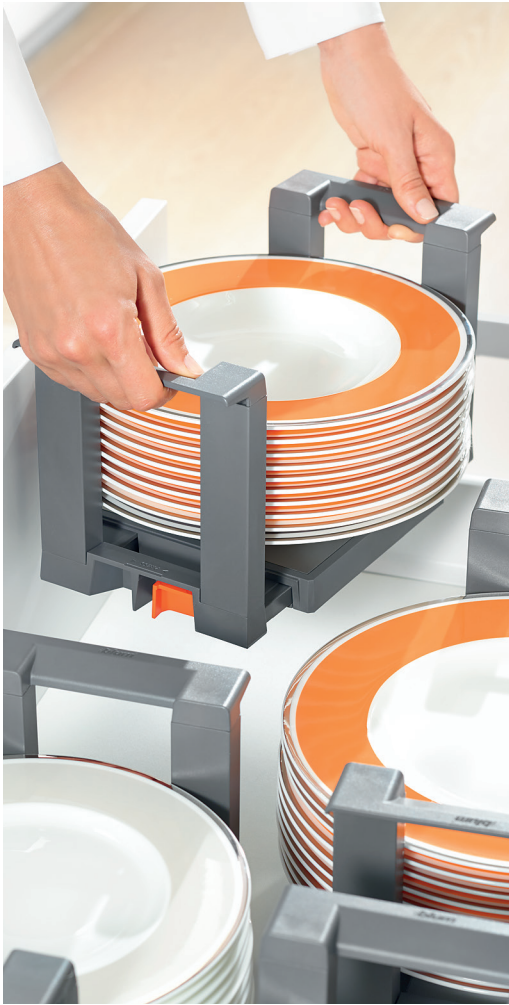

**Portapiatti**  
Plate-holder

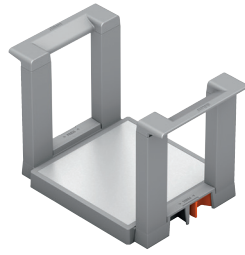

**CODICE / CODE No.**

**grigio**  
grey

08702080