

GRUPPOLUBE



ELEMENTI A GIORNO

2024

SPECIFICHE TECNICHE MOBILI A GIORNO

OPEN UNITS TECHNICAL SPECIFICATIONS

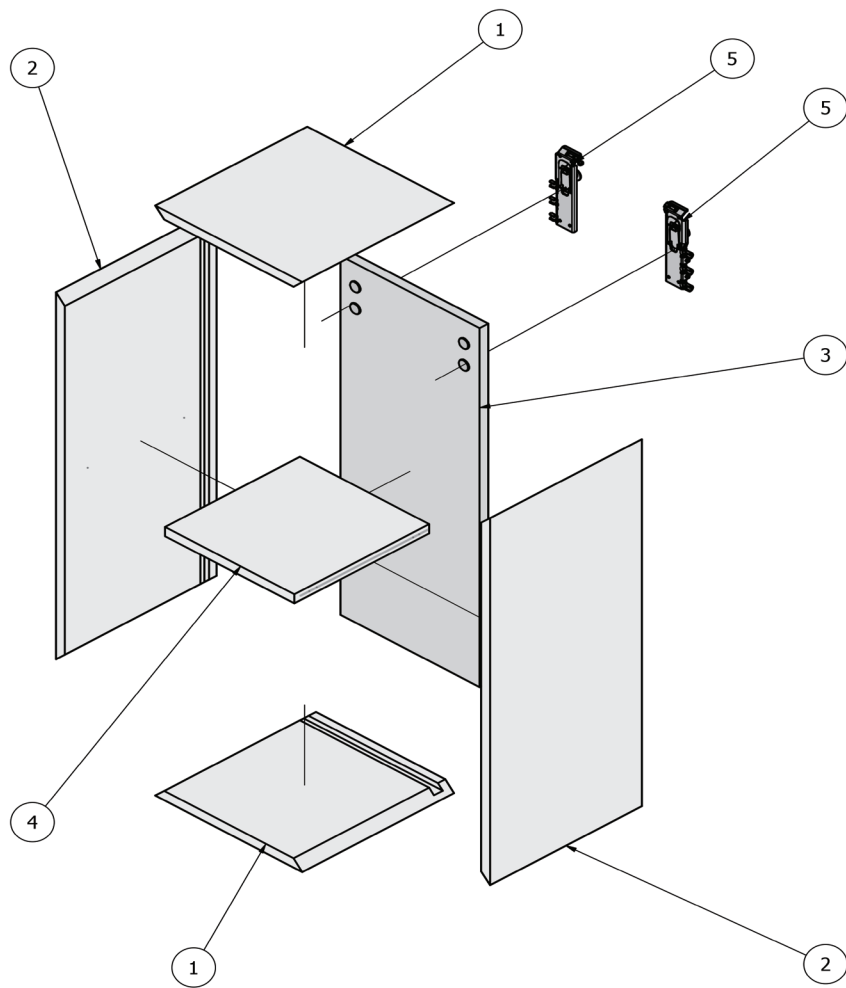

-1: Cielo e fondo folding

Folding top and bottom

-2: Fianchi folding

Folding side panels

-3: Schiena

Back panel

-4: Ripiano

Shelf

-5: Attaccaglie a scomparsa

Invisible hangers

- PROFONDITÀ 310mm

DEPTH 310mm

- STRUTTURA SPESSORE 18mm

STRUCTURE THICKNESS 18mm

- REALIZZATI IN FOLDING (escluso laccato lucido)

PRODUCED IN FOLDING (excluding glossy lacquered)

- ATTACCAGLIE A SCOMPARSA (con tappi neutri)

INVISIBLE HANGERS (with neutral caps)

- SCHIENA SPESSORE 18mm (disponibile anche a contrasto)

BACK PANEL THICKNESS 18mm (also available in contrasting colour)

- RIPIANI IN LEGNO (in tinta) O IN VETRO (extrachiaro Sp. 8mm)

WOOD SHELVES (in matching colour) OR GLASS (extraclear Th. 8mm)

- RIPIANI RIMOVIBILI (per permettere il montaggio delle luci)

REMOVABLE SHELVES (to allow the assembly of lights)

- POSSIBILITÀ DI INSERIRE PROFILI LED E FARETTI

POSSIBILITY TO INSERT LED PROFILES AND SPOTLIGHTS



MOBILE A GIORNO SENZA LUCE

OPEN UNIT WITHOUT LIGHT

Ripiano legno

Wood shelf

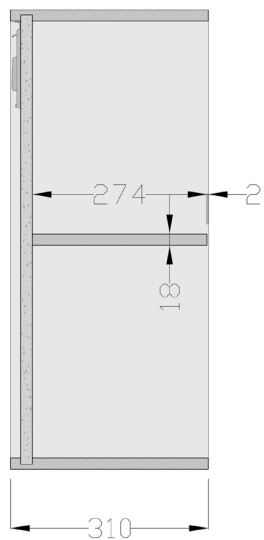

Ripiano vetro

Glass shelf

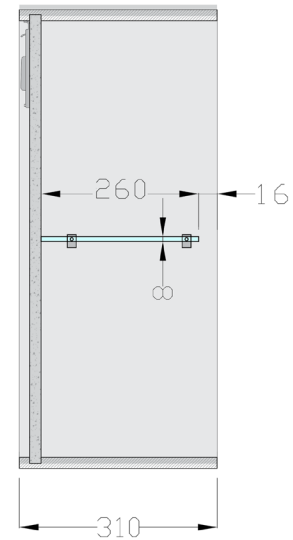

MOBILE A GIORNO CON LUCE LED SU RIPIANO

OPEN UNIT WITH LIGHT

Ripiano legno

Wood shelf

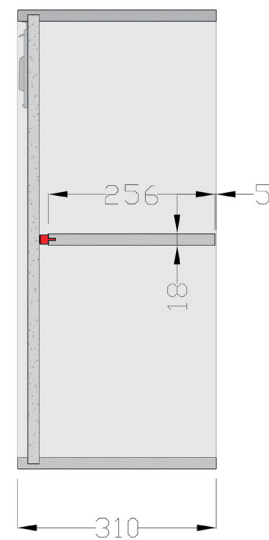

Ripiano vetro

Glass shelf

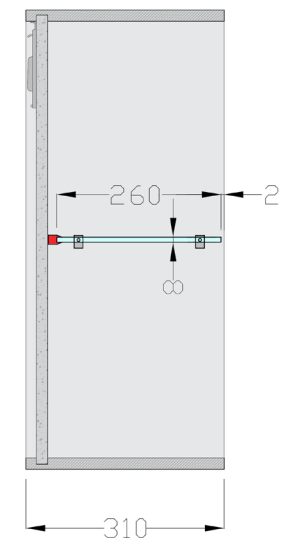

 **PROFILO LED "SIRENUSE"**
"SIRENUSE" LED PROFILE

 **PROFILO LED "VIVARA"**
"VIVARA" LED PROFILE

MOBILI A GIORNO ORIZZONTALI
HORIZONTAL OPEN UNITS



MOBILI A GIORNO VERTICALI
VERTICAL OPEN UNITS

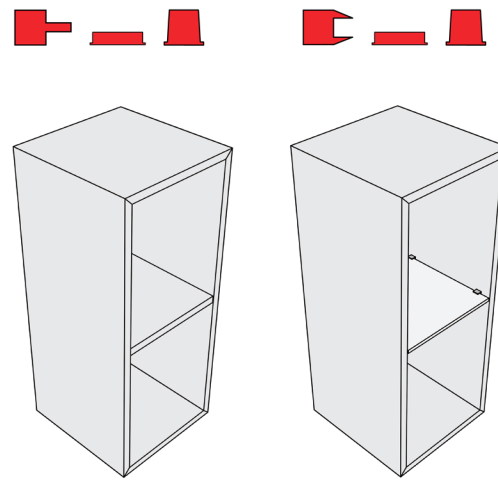

Ripiano legno
Wood shelf

Ripiano vetro
Glass shelf

MOBILI A GIORNO CON RIPIANO VELETTA
OPEN UNITS WITH VEIL SHELF



MOBILI A GIORNO TERMINALI
TERMINALS OPEN UNITS

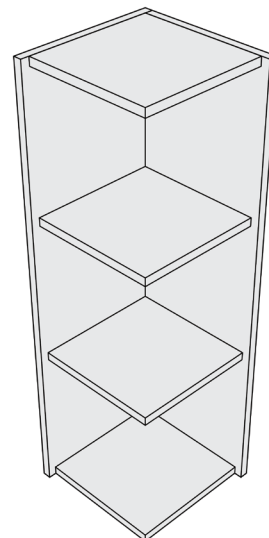

POSSIBILITÀ DI INSERIMENTO LUCI:
LIGHTS INSERTION POSSIBILITIES:



per informazioni tecniche vedi pag.14-17
for technical information see pages 14-17



PROFILO LED "SIRENUSE"
"SIRENUSE" LED PROFILE



PROFILO LED "VIVARA"
"VIVARA" LED PROFILE



FARETTO "SUNRISE"
"SUNRISE" SPOTLIGHT



INCASSO LED "KENDO" e "MINI-NOOR"
RECESSED LED "KENDO" and "MINI-NOOR"

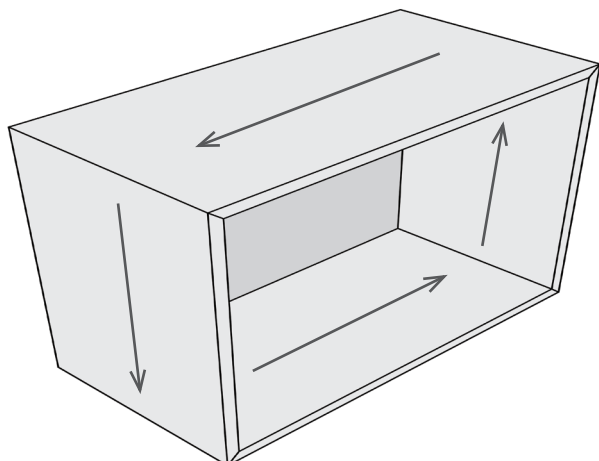

I mobili a giorno in melaminico e in laccato uv opaco avranno sempre il decorativo frontale distribuito perimetralmente nella parte esterna.

Il lato interno sarà rifinito come il retro dell'anta.

Open cabinets in melamine and matt uv lacquer will always have the decorative front distributed around the outside. The inside will be finished like the back of the door.

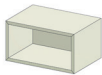
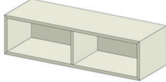
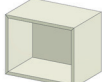
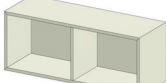
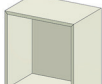
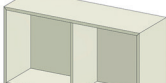
			NOBILITATI	MELAMINICI	IMPALLACCIATO FASCIA A	IMPALLACCIATO FASCIA B	IMPALLACCIATO FASCIA C	LACCATO UV OPACO	LACCATO OPACO	
		COD.	B	C	I	I	I	L	L	
 <p>pensile H 24 P 31 a giorno 1 vano attaccaglie a scomparsa open wall unit H 24 D 31 1 compartment concealed hangers</p>	<p>L da 10 a 30</p> <p>L 45</p> <p>L 60</p> <p>L 65</p> <p>L 75</p> <p>L 90</p>	EJ2ABA30								
		EJ2ABA45								
		EJ2ABA60								
		EJ2ABA65								
		EJ2ABA75								
		EJ2ABA90								
 <p>pensile H 24 P 31 a giorno 2 vani attaccaglie a scomparsa open wall unit H 24 D 31 2 compartments concealed hangers</p>	<p>L 60</p> <p>L 65</p> <p>L 75</p> <p>L 90</p> <p>L 120</p>	EJ2CBA60								
		EJ2CBA65								
		EJ2CBA75								
		EJ2CBA90								
		EJ2CBA96								
 <p>pensile H 36 P 31 a giorno 1 vano attaccaglie a scomparsa open wall unit H 36 D 31 1 compartment concealed hangers</p>	<p>L da 10 a 30</p> <p>L 45</p> <p>L 60</p> <p>L 65</p> <p>L 75</p> <p>L 90</p>	EJ2ACA30								
		EJ2ACA45								
		EJ2ACA60								
		EJ2ACA65								
		EJ2ACA75								
		EJ2ACA90								
 <p>pensile H 36 P 31 a giorno 2 vani attaccaglie a scomparsa open wall unit H 36 D 31 2 compartments concealed hangers</p>	<p>L 60</p> <p>L 65</p> <p>L 75</p> <p>L 90</p> <p>L 120</p>	EJ2CCA60								
		EJ2CCA65								
		EJ2CCA75								
		EJ2CCA90								
		EJ2CCA96								
 <p>pensile H 48 P 31 a giorno 1 vano attaccaglie a scomparsa open wall unit H 48 D 31 1 compartment concealed hangers</p>	<p>L da 10 a 30</p> <p>L 45</p> <p>L 60</p> <p>L 65</p> <p>L 75</p> <p>L 90</p>	EJ2AEA30								
		EJ2AEA45								
		EJ2AEA60								
		EJ2AEA65								
		EJ2AEA75								
		EJ2AEA90								
 <p>pensile H 48 P 31 a giorno 2 vani attaccaglie a scomparsa open wall unit H 48 D 31 2 compartments concealed hangers</p>	<p>L 60</p> <p>L 65</p> <p>L 75</p> <p>L 90</p> <p>L 120</p>	EJ2CEA60								
		EJ2CEA65								
		EJ2CEA75								
		EJ2CEA90								
		EJ2CEA96								

N.B.: per variante con luce vedi pag.2-3

Note: for variant with light see page 2-3

N.B.: al codice indicato al listino, aggiungere alla fine la lettera che identifica la finitura

Note: to the code indicated in the price list, add the letter that identifies the finish at the end

N.B.: per maggiorazioni schiene vedi pag.12

Note: for back surcharges see page 12

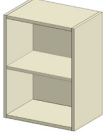
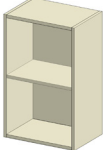
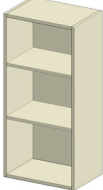
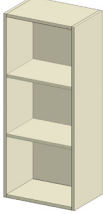
			NOBILITATI	MELAMINICI	IMPALLACCIATO FASCIA A	IMPALLACCIATO FASCIA B	IMPALLACCIATO FASCIA C	LACCATO UV OPACO	LACCATO OPACO	
		COD.	B	C	I	I	I	L	L	
 <p>pensile H 60 a giorno 2 vani e 1 ripiano attaccaglie a scomparsa open wall unit H 60 2 compartments and 1 shelf concealed hangers</p>	L da 10 a 30	EJ2EFA30								
	magg. ripiano vetro surcharge glass shelf	OPZ.005								
	L 45	EJ2EFA45								
	magg. ripiano vetro surcharge glass shelf	OPZ.005								
	L 60	EJ2EFA60								
	magg. ripiano vetro surcharge glass shelf	OPZ.005								
	L 65	EJ2EFA65								
	magg. ripiano vetro surcharge glass shelf	OPZ.005								
 <p>pensile H 72 a giorno 2 vani e 1 ripiano attaccaglie a scomparsa open wall unit H 72 2 compartments and 1 shelf concealed hangers</p>	L da 10 a 30	EJ2EGA30								
	magg. ripiano vetro surcharge glass shelf	OPZ.005								
	L 45	EJ2EGA45								
	magg. ripiano vetro surcharge glass shelf	OPZ.005								
	L 60	EJ2EGA60								
	magg. ripiano vetro surcharge glass shelf	OPZ.005								
	L 65	EJ2EGA65								
	magg. ripiano vetro surcharge glass shelf	OPZ.005								
 <p>pensile H 96 a giorno 3 vani e 2 ripiani attaccaglie a scomparsa open wall unit H 96 3 compartments and 2 shelves concealed hangers</p>	L da 10 a 30	EJ2EKA30								
	magg. ripiano vetro surcharge glass shelf	OPZ.005								
	L 45	EJ2EKA45								
	magg. ripiano vetro surcharge glass shelf	OPZ.005								
	L 60	EJ2EKA60								
	magg. ripiano vetro surcharge glass shelf	OPZ.005								
	L 65	EJ2EKA65								
	magg. ripiano vetro surcharge glass shelf	OPZ.005								
 <p>pensile H 108 a giorno 3 vani e 2 ripiani attaccaglie a scomparsa open wall unit H 108 3 compartments and 2 shelves concealed hangers</p>	L da 10 a 30	EJ2ELA30								
	magg. ripiano vetro surcharge glass shelf	OPZ.005								
	L 45	EJ2ELA45								
	magg. ripiano vetro surcharge glass shelf	OPZ.005								

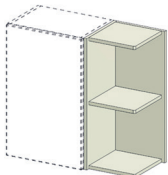
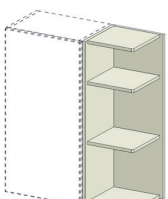
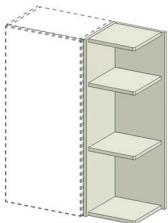
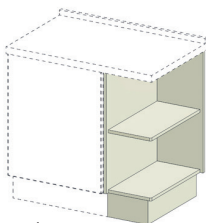
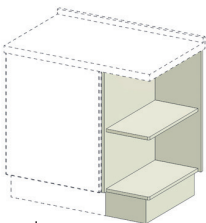
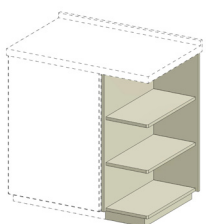
			NOBILITATI	MELAMINICI	IMPALLACCIATO FASCIA A	IMPALLACCIATO FASCIA B	IMPALLACCIATO FASCIA C	LACCATO UV OPACO	LACCATO OPACO	
		COD.	B	C	I	I	I	L	L	
<p>N.B.: variante luce non disponibile Note: light variant not available N.B.: al codice indicato al listino, aggiungere alla fine la lettera che identifica la finitura Note: to the code indicated in the price list, add the letter that identifies the finish at the end</p>										
 terminale pensile P 31 a giorno 2 vani end open wall unit D 31 2 compartments verso dx RH version	H 60 L 31 EJ2TFA31/2									
	H 72 L 31 EJ2TGA31/2									
 terminale pensile H 96 P 31 a giorno 3 vani end open wall unit H 96 D 31 3 compartments verso dx RH version	H 96 L 31 EJ2TKA31/2									
 terminale pensile H 108 P 31 a giorno 3 vani end open wall unit H 108 D 31 3 compartments verso dx RH version	H 108 L 31 EJ2TLA31/2									
 terminale base H 85 a giorno 2 vani end open base unit H 85 2 compartments verso dx RH version	P 57,5x31 EJ4TGM31/2									
	P 61x31 EJ4TGP31/2									
 terminale base H 88 a giorno 2 vani end open base unit H 88 2 compartments verso dx RH version	P 57,5x31 EJ4THM31/2									
	P 61x31 EJ4THP31/2									
 terminale base H 90 a giorno 3 vani end open base unit H 90 3 compartments verso dx RH version	P 57,5x31 EJ4TJM31/2									
	P 61x31 EJ4TJP31/2									

N.B.: per variante con luce vedi pag.2-3

Note: for variant with light see page 2-3

N.B.: al codice indicato al listino, aggiungere alla fine la lettera che identifica la finitura

Note: to the code indicated in the price list, add the letter that identifies the finish at the end

N.B.: per maggiorazioni schiene vedi pag.12

Note: for back surcharges see page 12

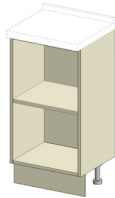
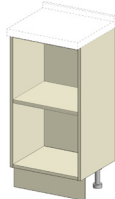
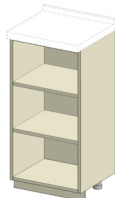
			NOBILITATI	MELAMINICI	IMPALLACCIATO FASCIA A	IMPALLACCIATO FASCIA B	IMPALLACCIATO FASCIA C	LACCATO UV OPACO	LACCATO OPACO	
		COD.	B	C	I	I	I	L	L	
 <p>base H 85 P 31 a giorno 2 vani e 1 ripiano per versione Bridge open base unit H 85 D 31 2 compartments and 1 shelve for Bridge version</p>										
		L da 10 a 30	EJ4EGA30							
	magg. ripiano vetro	surcharge glass shelf	OPZ.005							
		L 45	EJ4EGA45							
	magg. ripiano vetro	surcharge glass shelf	OPZ.005							
		L 60	EJ4EGA60							
	magg. ripiano vetro	surcharge glass shelf	OPZ.005							
		L 65	EJ4EGA65							
	L 75	EJ4EGA75								
magg. ripiano vetro	surcharge glass shelf	OPZ.005								
 <p>base H 88 P 31 a giorno 2 vani e 1 ripiano per versione Neck open base unit H 88 D 31 2 compartments and 1 shelve for Neck version</p>										
		L da 10 a 30	EJ4EHA30							
	magg. ripiano vetro	surcharge glass shelf	OPZ.005							
		L 45	EJ4EHA45							
	magg. ripiano vetro	surcharge glass shelf	OPZ.005							
		L 60	EJ4EHA60							
	magg. ripiano vetro	surcharge glass shelf	OPZ.005							
		L 65	EJ4EHA65							
	L 75	EJ4EHA75								
magg. ripiano vetro	surcharge glass shelf	OPZ.005								
 <p>base H 90 P 31 a giorno 3 vani e 2 ripiani open base unit H 90 D 31 3 compartments and 2 shelves</p>										
		L da 10 a 30	EJ4EJA30							
	magg. ripiano vetro	surcharge glass shelf	OPZ.005							
		L 45	EJ4EJA45							
	magg. ripiano vetro	surcharge glass shelf	OPZ.005							
		L 60	EJ4EJA60							
	magg. ripiano vetro	surcharge glass shelf	OPZ.005							
		L 65	EJ4EJA65							
magg. ripiano vetro	surcharge glass shelf	OPZ.005								
	L 75	EJ4EJA75								
magg. ripiano vetro	surcharge glass shelf	OPZ.005								

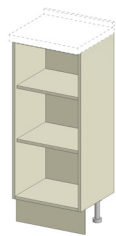
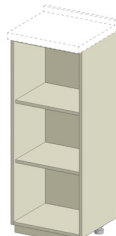
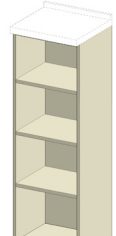
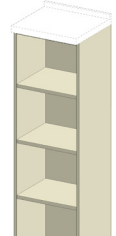
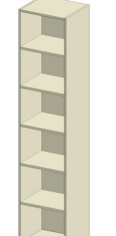
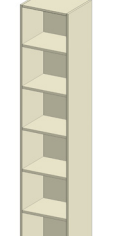
		NOBILITATI	MELAMINICI	IMPALLACCIATO FASCIA A	IMPALLACCIATO FASCIA B	IMPALLACCIATO FASCIA C	LACCATO UV OPACO	LACCATO OPACO
		COD.	B	C	I	I	L	L
 <p>colonna H 109 P 31 a giorno 3 vani e 2 ripiani open column H 109 D 31 3 compartments and 2 shelves</p>	L da 10 a 30	EJ7EKA30						
	magg. ripiano vetro surcharge glass shelf	OPZ.005						
	L 45	EJ7EKA45						
	magg. ripiano vetro surcharge glass shelf	OPZ.005						
	L 60	EJ7EKA60						
	magg. ripiano vetro surcharge glass shelf	OPZ.005						
 <p>colonna H 114 P 31 a giorno 3 vani e 2 ripiani open column H 114 D 31 3 compartments and 2 shelves</p>	L da 10 a 30	EJ7ELA30						
	magg. ripiano vetro surcharge glass shelf	OPZ.005						
	L 45	EJ7ELA45						
	magg. ripiano vetro surcharge glass shelf	OPZ.005						
	L 60	EJ7ELA60						
	magg. ripiano vetro surcharge glass shelf	OPZ.005						
 <p>colonna H 145 P 31 a giorno 4 vani e 3 ripiani open column H 145 D 31 4 compartments and 3 shelves</p>	L da 10 a 30	EJ7EPA30						
	magg. ripiano vetro surcharge glass shelf	OPZ.005						
	L 45	EJ7EPA45						
	magg. ripiano vetro surcharge glass shelf	OPZ.005						
	L 60	EJ7EPA60						
	magg. ripiano vetro surcharge glass shelf	OPZ.005						
 <p>colonna H 150 P 31 a giorno 4 vani e 3 ripiani open column H 150 D 31 4 compartments and 3 shelves</p>	L da 10 a 30	EJ7ERA30						
	magg. ripiano vetro surcharge glass shelf	OPZ.005						
	L 45	EJ7ERA45						
	magg. ripiano vetro surcharge glass shelf	OPZ.005						
	L 60	EJ7ERA60						
	magg. ripiano vetro surcharge glass shelf	OPZ.005						
 <p>colonna H 217 P 31 a giorno 6 vani e 5 ripiani vetro open column H 217 D 31 6 compartments and 5 glass shelves</p>	L da 10 a 30	EJ7ESA30						
	magg. ripiano vetro surcharge glass shelf	OPZ.005						
	L 45	EJ7ESA45						
	magg. ripiano vetro surcharge glass shelf	OPZ.005						
	L 60	EJ7ESA60						
	magg. ripiano vetro surcharge glass shelf	OPZ.005						
 <p>colonna H 222 P 31 a giorno 6 vani e 5 ripiani vetro open column H 222 D 31 6 compartments and 5 glass shelves</p>	L da 10 a 30	EJ7ETA30						
	magg. ripiano vetro surcharge glass shelf	OPZ.005						
	L 45	EJ7ETA45						
	magg. ripiano vetro surcharge glass shelf	OPZ.005						
	L 60	EJ7ETA60						
	magg. ripiano vetro surcharge glass shelf	OPZ.005						

N.B.: variante luce non disponibile

Note: light variant not available

N.B.: al codice indicato al listino, aggiungere alla fine la lettera che identifica la finitura

Note: to the code indicated in the price list, add the letter that identifies the finish at the end

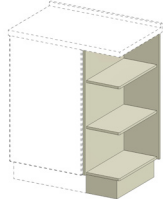
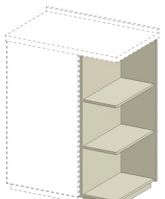
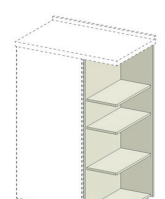
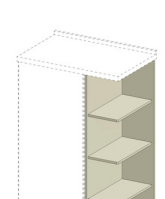
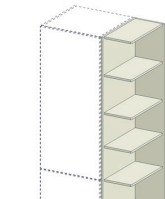
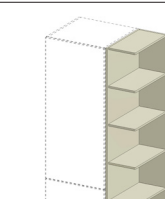
			NOBILITATI	MELAMINICI	IMPALLACCIATO FASCIA A	IMPALLACCIATO FASCIA B	IMPALLACCIATO FASCIA C	LACCATO UV OPACO	LACCATO OPACO	
		COD.	B	C	I	I	I	L	L	
 <p>terminale colonna H 109 a giorno 3 vani end open column H 109 3 compartments</p>	<p>verso dx RH version</p>	P 57,5x31	EJ7TKM31/2							
		P 61x31	EJ7TKP31/2							
 <p>terminale colonna H 114 a giorno 3 vani end open column H 114 3 compartments</p>	<p>verso dx RH version</p>	P 57,5x31	EJ7TLM31/2							
		P 61x31	EJ7TLP31/2							
 <p>terminale colonna H 145 a giorno 4 vani end open column H 145 4 compartments</p>	<p>verso dx RH version</p>	P 57,5x31	EJ7TPM31/2							
		P 61x31	EJ7TPP31/2							
 <p>terminale colonna H 150 a giorno 4 vani end open column H 150 4 compartments</p>	<p>verso dx RH version</p>	P 57,5x31	EJ7TRM31/2							
		P 61x31	EJ7TRP31/2							
 <p>terminale colonna H 217 a giorno 6 vani end open column H 217 6 compartments</p>	<p>verso dx RH version</p>	P 57,5x31	EJ7TSM31/2							
		P 61x31	EJ7TSP31/2							
 <p>terminale colonna H 222 a giorno 6 vani end open column H 222 6 compartments</p>	<p>verso dx RH version</p>	P 57,5x31	EJ7TSM31/2							
		P 61x31	EJ7TTP31/2							

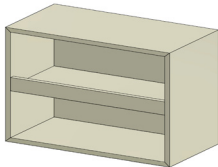
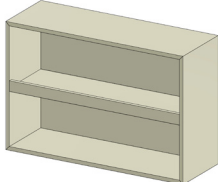
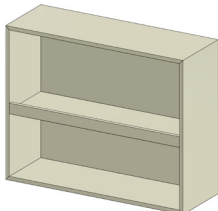
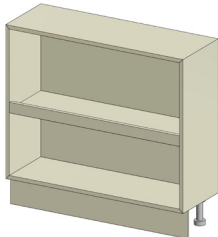
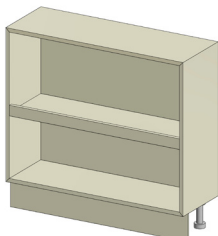
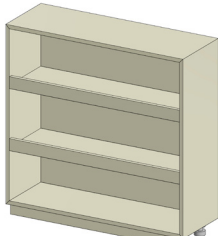
			NOBILITATI	MELAMINICI	IMPALLACCIATO FASCIA A	IMPALLACCIATO FASCIA B	IMPALLACCIATO FASCIA C	LACCATO UV	LACCATO OPACO	
		COD.	B	C	I	I	I	L	L	
 <p>pendente H 48 P 31 a giorno 2 vani e 1 ripano veletta N.B.: non si effettuano fuori misura open wall unit H 48 D 31 2 compartment and 1 veil shelf Note: custom-sized length unavailable</p>	L 60	EJ2GEA60								
	L 90	EJ2GEA90								
 <p>pendente H 60 P 31 a giorno 2 vani e 1 ripano veletta N.B.: non si effettuano fuori misura open wall unit H 60 D 31 2 compartment and 1 veil shelf Note: custom-sized length unavailable</p>	L 60	EJ2GFA60								
	L 90	EJ2GFA90								
 <p>pendente H 72 P 31 a giorno 2 vani e 1 ripano veletta N.B.: non si effettuano fuori misura open wall unit H 72 D 31 2 compartment and 1 veil shelf Note: custom-sized length unavailable</p>	L 60	EJ2GGA60								
	L 90	EJ2GGA90								
 <p>base H 85 P 31 a giorno 2 vani e 1 ripano veletta N.B.: non si effettuano fuori misura open base unit H 85 D 31 2 compartment and 1 veil shelf Note: custom-sized length unavailable</p>	L 60	EJ4GGA60								
	L 90	EJ4GGA90								
 <p>base H 88 P 31 a giorno 2 vani e 1 ripano veletta N.B.: non si effettuano fuori misura open base unit H 88 D 31 2 compartment and 1 veil shelf Note: custom-sized length unavailable</p>	L 60	EJ4GHA60								
	L 90	EJ4GHA90								
 <p>base H 90 P 31 a giorno 3 vani e 2 ripani veletta N.B.: non si effettuano fuori misura open base unit H 90 D 31 3 compartment and 2 veil shelves Note: custom-sized length unavailable</p>	L 60	EJ4GJA60								
	L 90	EJ4GJA90								

ELEMENTO ANGOLO IN APPOGGIO "OVER"

P 57,5

"OVER" SUPPORTING CORNER ELEMENT

N.B.: luce disponibile solo profilo sirenuse

Note: light available only sirenuse profile

N.B.: al codice indicato al listino, aggiungere alla fine la lettera che identifica la finitura

Note: to the code indicated in the price list, add the letter that identifies the finish at the end

N.B.: per maggiorazioni schiene vedi pag.12

Note: for back surcharges see page 12

elemento P 57,5 a giorno
3 vani e 2 ripiani veletta

N.B.: non si effettuano fuori misura

open wall unit D 57,5

3 compartment and 2 veil shelves

Note: custom-sized length unavailable

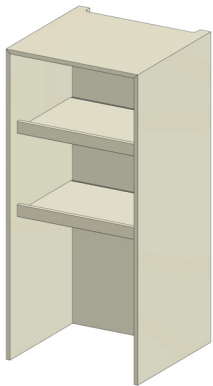

L 60 H 125	EJ9GAM60
L 60 H 126	EJ9GBM60
L 60 H 126,6	EJ9GCM60
L 60 H 126,8	EJ9GDM60
L 60 H 127	EJ9GEM60
L 60 H 127,8	EJ9GGM60
L 60 H 128	EJ9GHM60
L 60 H 129	EJ9GLM60
L 60 H 129,8	EJ9GNM60
L 60 H 130	EJ9GPM60
L 60 H 130,8	EJ9GRM60

	NOBILITATI	MELAMINICI	IMPALLACCIATO FASCIA A	IMPALLACCIATO FASCIA B	IMPALLACCIATO FASCIA C	LACCATO UV	LACCATO OPACO
COD.	B	C	I	I	I	L	L



MONTAGGIO LUCE RIPIANO

SHELF LIGHT INSTALLATION

forare la schiena con punta diametro 8 mm
drill the back with an 8 mm diameter bit

1

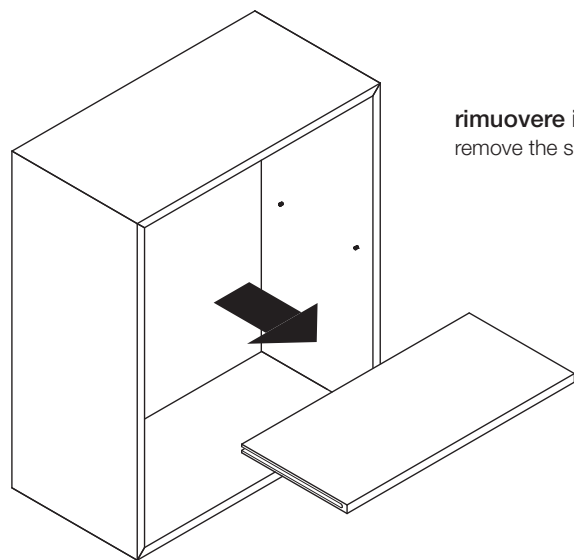

rimuovere il ripiano sfilandolo in avanti
remove the shelf by sliding it forwards

3

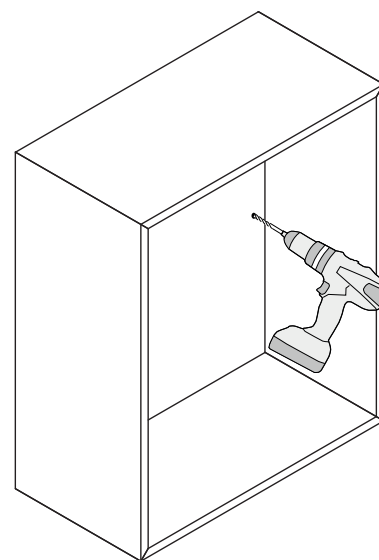

passare il filo all'interno del foro e posizionare il ripiano
pass the wire inside the hole and position the shelf

2

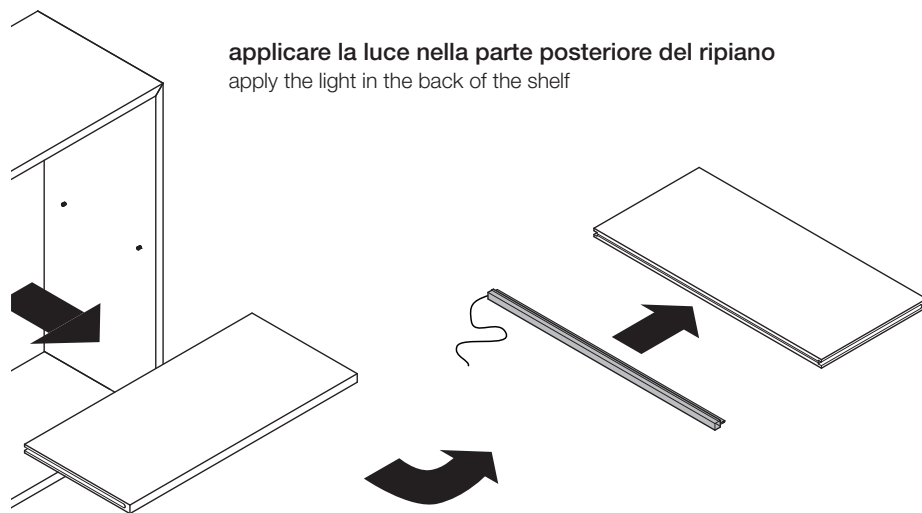

applicare la luce nella parte posteriore del ripiano
apply the light in the back of the shelf

4

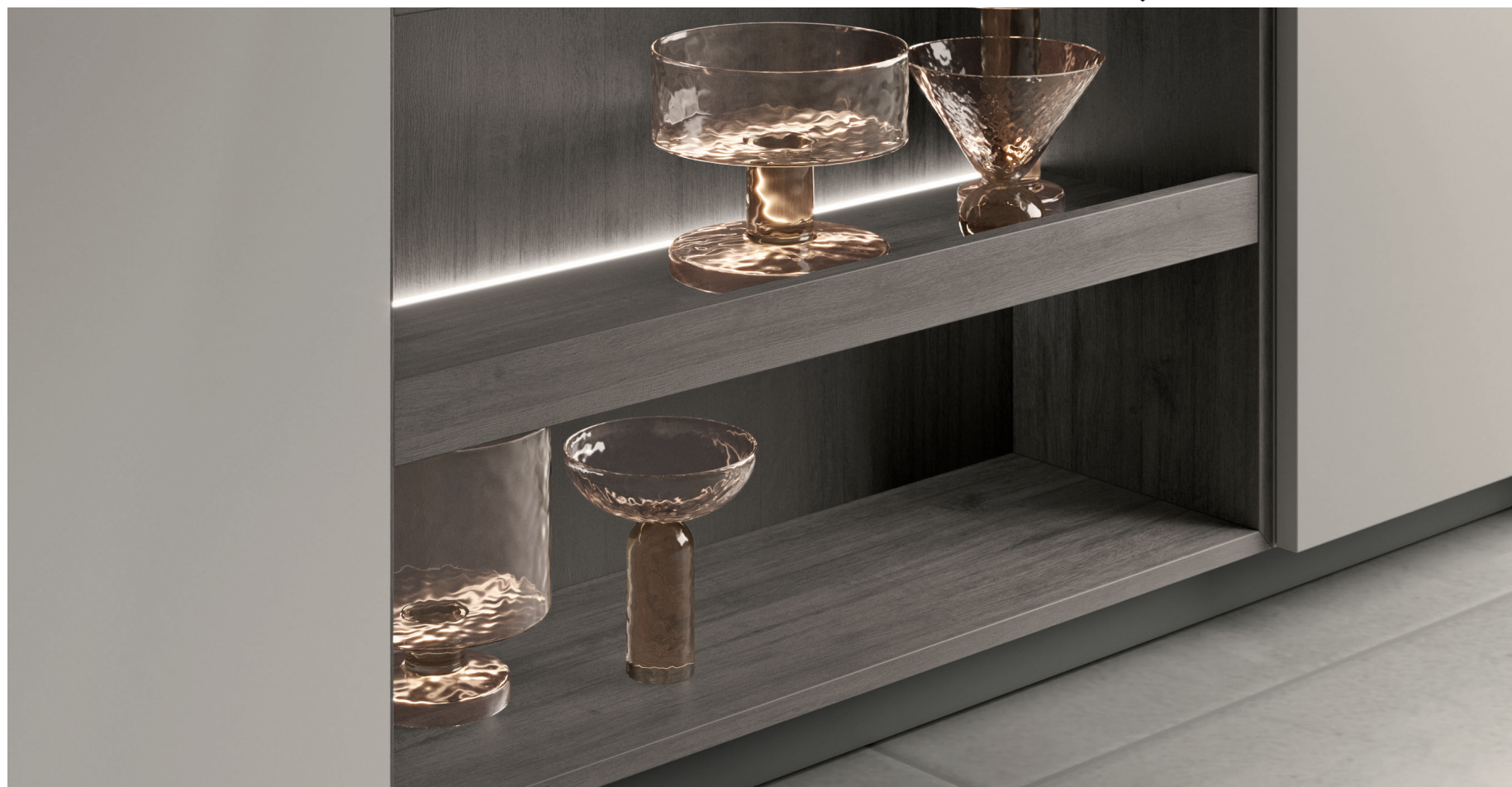
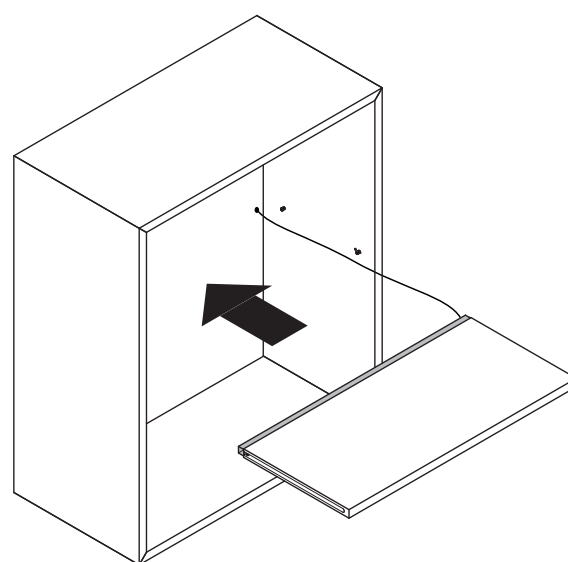

LUCE SIRENUSE EDC PER RIPANI LEGNO

SIRENUSE EDC LIGHT FOR WOOD SHELF

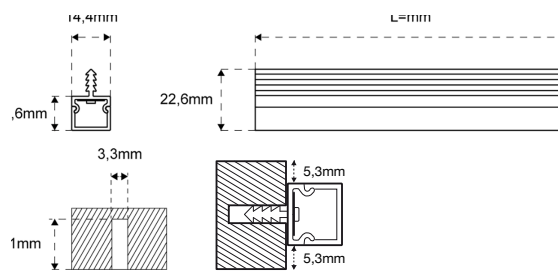
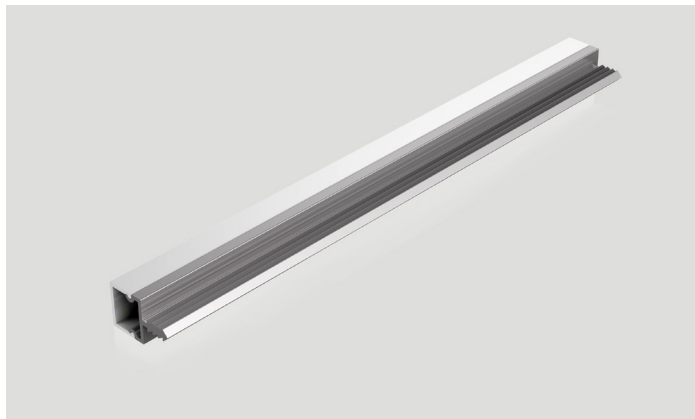
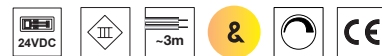

TIPI DI ACCENSIONE POWER SWITCH ON TYPES

Alimentazione basilare/Connessione diretta
(Vedi pag.30)
Simple power supply/Direct connection
(See page 30)

Accensione con telecomando 1 zona
(Vedi pag.32)
Switch on with remote control 1 area
(See page 32)

Accensione con app "BlueSmart" o telecomando 4 zone
(Vedi pag.33)
Switch on with "BlueSmart" app or remote control 4 areas
(See page 33)



Alluminio anodizzato

SIRENUSE

	90500391200BED	3,4 W	262 mm	3000-4000K	(L 300 mm)
	90500411200BED	5,4 W	412 mm	3000-4000K	(L 450 mm)
	90500421200BED	7,4 W	562 mm	3000-4000K	(L 600 mm)
	90500431200BED	8,1 W	612 mm	3000-4000K	(L 650 mm)
	90500441200BED	9,5 W	712 mm	3000-4000K	(L 750 mm)

codice code
08618381
08618383
08618384
08618385
08618386



EMOTION DUAL COLOR

La temperatura colore varia da bianco "caldo" a "naturale" (3000-4000K) variabile tramite telecomando o cambio spinotto cavo

The colour temperature varies from "warm" to "natural" white (3000-4000K) variable via remote control or cable plug change

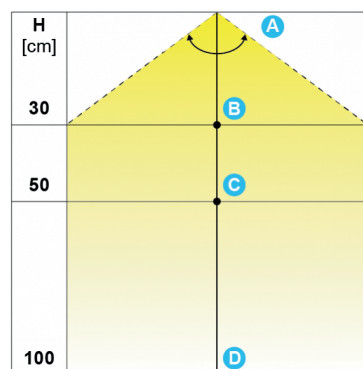

A°
110°
B - Lux
2700
C - Lux
970
D - Lux
240

700 mm
650 lm
90 lm/W
CRI>80

LUCE VIVARA PER RIPANI VETRO

VIVARA LIGHT FOR GLASS SHELF

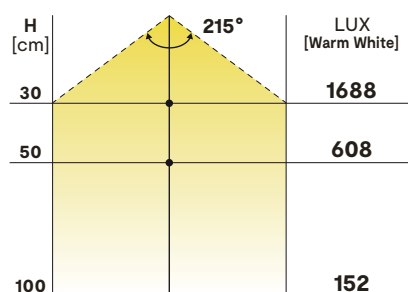
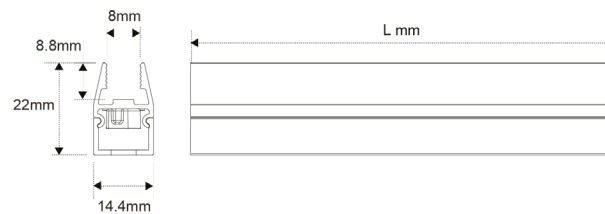
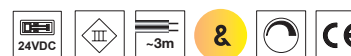

Alluminio anodizzato

860 mm
569 lm
76 lm/W
CRI>80

TIPI DI ACCENSIONE POWER SWITCH ON TYPES

Alimentazione basilare/Connessione diretta
(Vedi pag.30)
Simple power supply/Direct connection
(See page 30)

Accensione con sensore all'apertura dell'anta
(Vedi pag.31)
Switch on with sensor on the door opening
(See page 31)

Accensione con telecomando 1 zona
(Vedi pag.32)
Switch on with remote control 1 area
(See page 32)

Accensione con app "BlueSmart" o telecomando 4 zone
(Vedi pag.33)
Switch on with "BlueSmart" app or remote control 4 areas
(See page 33)

VIVARA 8						codice code
	91500021200AED	3,3 W	257 mm	3000-4000K	(L 300 mm)	08618351
	91500041200AED	5,2 W	407 mm	3000-4000K	(L 450 mm)	08618353
	91500051200AED	7,2 W	557 mm	3000-4000K	(L 600 mm)	08618354
	91500061200AED	7,8 W	607 mm	3000-4000K	(L 650 mm)	08618355
	91500431200AED	8,5 W	707 mm	3000-4000K	(L 750 mm)	08618367



EMOTION DUAL COLOR

La temperatura colore varia da bianco "caldo" a "naturale" (3000-4000K) variabile tramite telecomando o cambio spinotto cavo

The colour temperature varies from "warm" to "natural" white (3000-4000K) variable via remote control or cable plug change

LUCE SUNRISE 58

SUNRISE 58 LIGHT



SUNRISE 58

Incasso

Sunrise 58 è un faretto ad incasso in alluminio con diffusore in policarbonato opalino. Proposto in tre finiture, trova applicazione come sottopensile, dove può essere installato ad incasso. La sorgente LED Emotion Dual Color permette la variazione da 3000K a 4000K.

Recessed

Sunrise 58 is a recessed aluminium spotlight with opal polycarbonate diffuser. Available in three finishes, it can be used as an under wall unit, where it can be installed recessed.

The LED source Emotion Dual Color colour temperature which allows the variation from 3000K to 4000K.

H [cm]	60°	Natural 4000K	EDC 4000K
30		1400 lx	1400 lx
50		470 lx	470 lx
100		130 lx	130 lx

332 lm
84 lm/W
CRI>80

SUNRISE 58

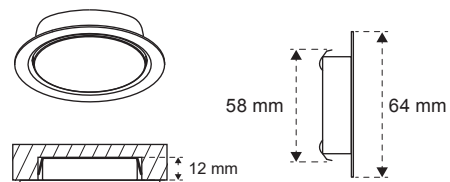
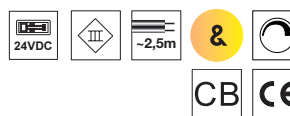

Metallic grey



Acciaio spazzolato

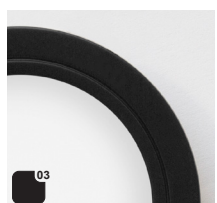

Nero

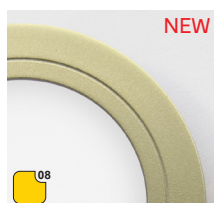

Oro

TIPI DI ACCENSIONE POWER SWITCH ON TYPES

Alimentazione basilare/Connessione diretta
(Vedi pag.30)
Simple power supply/Direct connection
(See page 30)

Accensione con sensore all'apertura dell'anta
(Vedi pag.31)
Switch on with sensor on the door opening
(See page 31)

Accensione con telecomando 1 zona
(Vedi pag.32)
Switch on with remote control 1 area
(See page 32)

Accensione con app "BlueSmart" o telecomando 4 zone
(Vedi pag.33)
Switch on with "BlueSmart" app or remote control 4 areas
(See page 33)

SUNRISE 58 EDC 24 V

	28100046500ZD	4 W	Ø 58 mm	3000-4000K
	28100049100ZD	4 W	Ø 58 mm	3000-4000K
	28100040300ZD	4 W	Ø 58 mm	3000-4000K
	28100010800ZD	4 W	Ø 58 mm	3000-4000K

codice code

08618082
08618081
08618080
08618083



EMOTION DUAL COLOR

La temperatura colore varia da bianco "caldo" a "naturale" (3000-4000K) variabile tramite telecomando o cambio spinotto cavo

The colour temperature varies from "warm" to "natural" white (3000-4000K) variable via remote control or cable plug change

SPECIFICHE TECNICHE MOBILI A GIORNO "SLIM"

"SLIM" OPEN UNITS TECHNICAL SPECIFICATIONS

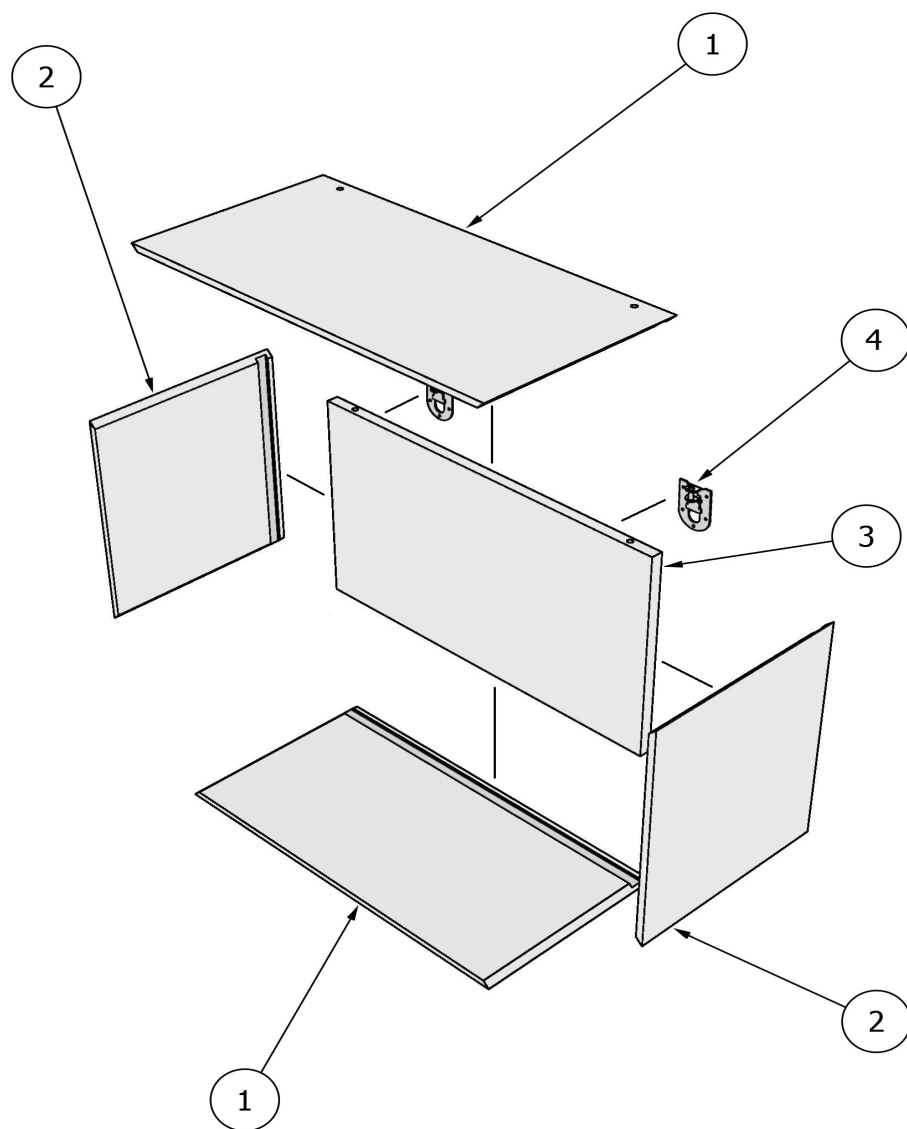

- **DISPONIBILI SOLO LACCATI OPACHI**
AVAILABLE ONLY IN MATT LACQUERED

- **PROFONDITÀ 310mm**
DEPTH 310mm

- **STRUTTURA SPESSORE 10mm**
STRUCTURE THICKNESS 10mm

- **REALIZZATI IN FOLDING**
PRODUCED IN FOLDING

- **ATTACCAGLIE A SCOMPARSA**
INVISIBLE HANGERS

- **SCHIENA SPESSORE 18mm (disponibile solo in tinta)**
BACK PANEL THICKNESS 18mm (available only in matching colour)

- **RIPIANI IN LEGNO (in tinta)**
WOOD SHELVES (in matching colour)

-1: **Cielo e fondo folding**
Folding top and bottom

-2: **Fianchi folding**
Folding side panels

-3: **Schiena**
Back panel

-4: **Attaccaglie a scomparsa**
Invisible hangers



MOBILI A GIORNO "SLIM" ORIZZONTALI
HORIZONTAL "SLIM" OPEN UNITS

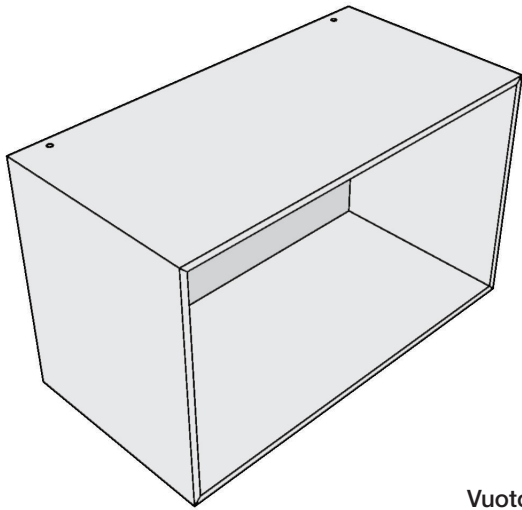

Vuoto
Empty

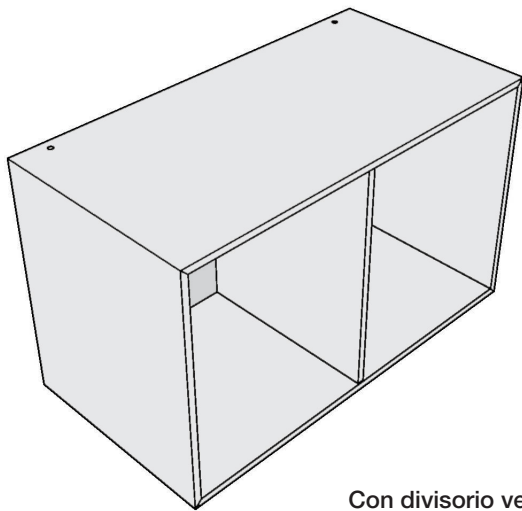

Con divisorio verticale
With vertical divider

Sezione tecnica
Technical section

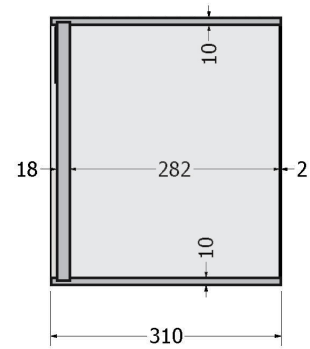

MOBILI A GIORNO "SLIM" VERTICALI
VERTICAL "SLIM" OPEN UNITS

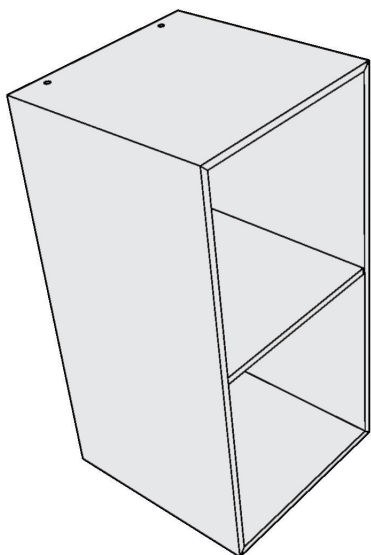

Sezione tecnica
Technical section

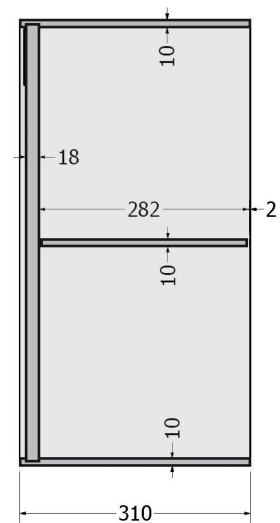

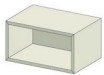
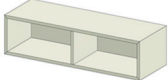
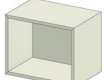
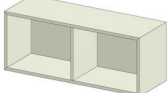
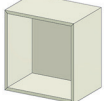
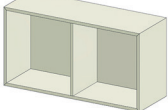
		LACCATO OPACO	
<p>N.B.: variante luce non disponibile Note: light variant not available</p>			
		COD.	
 <p>pensile H 24 P 31 a giorno 1 vano attaccaglie a scomparsa open wall unit H 24 D 31 1 compartment concealed hangers</p>	L 30	EJ1ABA30L	
	L 45	EJ1ABA45L	
	L 60	EJ1ABA60L	
	L 75	EJ1ABA75L	
	L 90	EJ1ABA90L	
 <p>pensile H 24 P 31 a giorno 2 vani attaccaglie a scomparsa open wall unit H 24 D 31 2 compartments concealed hangers</p>	L 60	EJ1CBA60L	
	L 75	EJ1CBA75L	
	L 90	EJ1CBA90L	
	L 120	EJ1CBA96L	
 <p>pensile H 36 P 31 a giorno 1 vano attaccaglie a scomparsa open wall unit H 36 D 31 1 compartment concealed hangers</p>	L 30	EJ1ACA30L	
	L 45	EJ1ACA45L	
	L 60	EJ1ACA60L	
	L 75	EJ1ACA75L	
	L 90	EJ1ACA90L	
 <p>pensile H 36 P 31 a giorno 2 vani attaccaglie a scomparsa open wall unit H 36 D 31 2 compartments concealed hangers</p>	L 60	EJ1CCA60L	
	L 75	EJ1CCA75L	
	L 90	EJ1CCA90L	
	L 120	EJ1CCA96L	
 <p>pensile H 48 P 31 a giorno 1 vano attaccaglie a scomparsa open wall unit H 48 D 31 1 compartment concealed hangers</p>	L 30	EJ1AEA30L	
	L 45	EJ1AEA45L	
	L 60	EJ1AEA60L	
	L 75	EJ1AEA75L	
	L 90	EJ1AEA90L	
 <p>pensile H 48 P 31 a giorno 2 vani attaccaglie a scomparsa open wall unit H 48 D 31 2 compartments concealed hangers</p>	L 60	EJ1CEA60L	
	L 75	EJ1CEA75L	
	L 90	EJ1CEA90L	
	L 120	EJ1CEA96L	

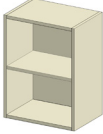
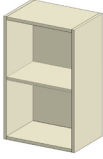
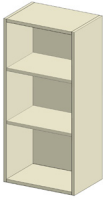
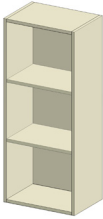
<p>N.B.: variante luce non disponibile Note: light variant not available</p>			LACCATO OPACO
		COD.	
 <p>pensile H 60 a giorno 2 vani e 1 ripiani in tinta attaccaglie a scomparsa open wall unit H 60 2 compartments and 1 shelves matching concealed hangers</p>	L 30	EJ1EFA30L	
	L 45	EJ1EFA45L	
 <p>pensile H 72 a giorno 3 vani e 2 ripiani in tinta attaccaglie a scomparsa open wall unit H 72 3 compartments and 2 shelves matching concealed hangers</p>	L 30	EJ1EGA30L	
	L 45	EJ1EGA45L	
 <p>pensile H 96 a giorno 3 vani e 2 ripiani in tinta attaccaglie a scomparsa open wall unit H 96 3 compartments and 2 shelves matching concealed hangers</p>	L 30	EJ1EKA30L	
	L 45	EJ1EKA45L	
 <p>pensile H 108 a giorno 3 vani e 2 ripiani in tinta attaccaglie a scomparsa open wall unit H 108 3 compartments and 2 shelves matching concealed hangers</p>	L 30	EJ1ELA30L	
	L 45	EJ1ELA45L	

SPECIFICHE TECNICHE TERMINALI A GIORNO "ROW"

"ROW" OPEN TERMINAL UNITS TECHNICAL SPECIFICATIONS

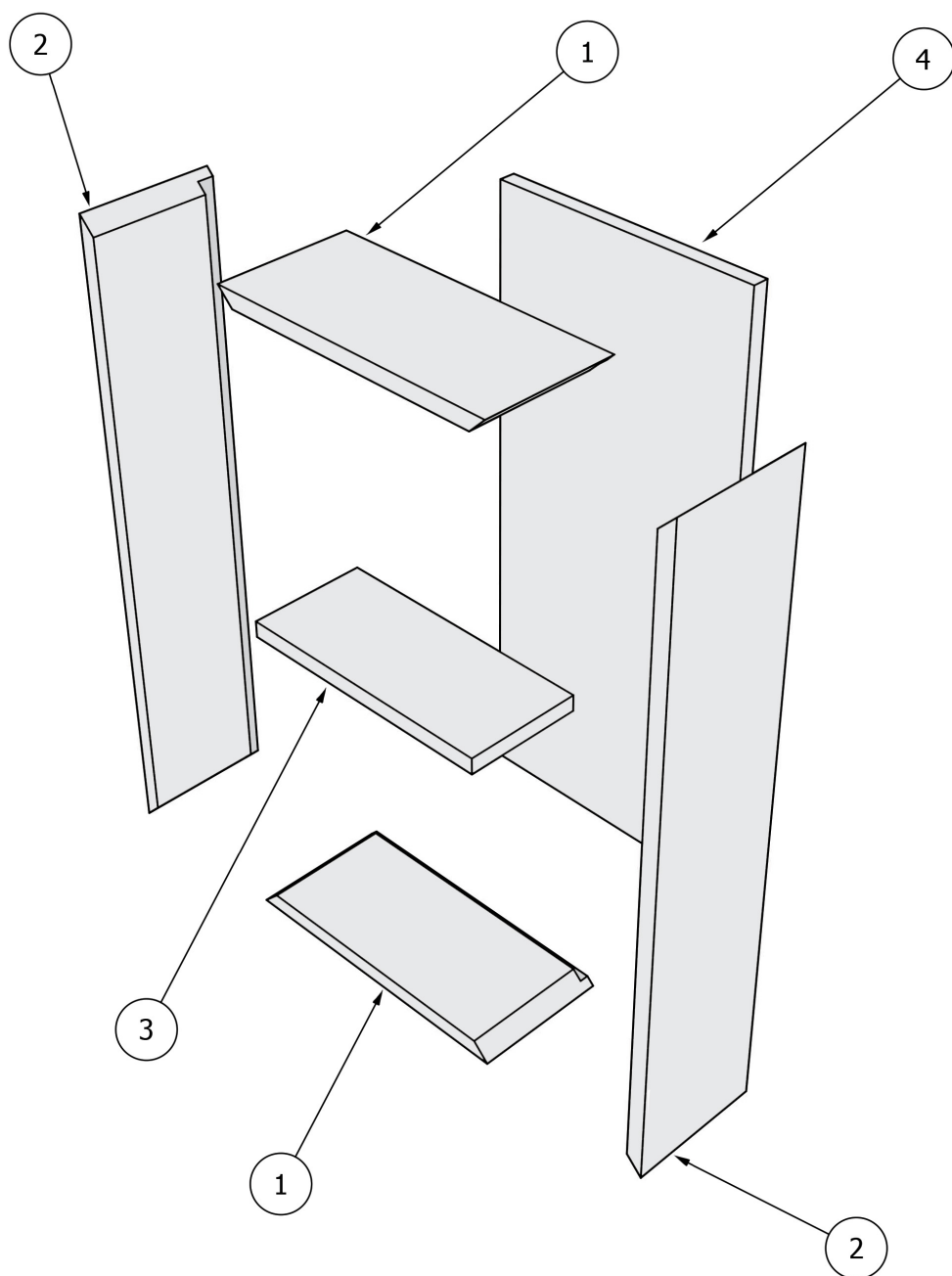

- **DISPONIBILI IN MELAMINICO E LACCATO UV OPACO**
AVAILABLE ONLY IN MELAMINE AND MATT UV LACQUERED

- **DOPPIA PROFONDITÀ A FILO ANTA PER MODELLI Sp.18mm e Sp.22mm**
DOUBLE DEPTH IN LINE WITH THE DOOR FOR MODELS THICKNESS 18mm AND THICKNESS 22mm

- **LARGHEZZA 150mm**
LENGTH 150mm

- **STRUTTURA SPESSORE 18mm**
STRUCTURE THICKNESS 18mm

- **REALIZZATI IN FOLDING**
PRODUCED IN FOLDING

- **SCHIENA SPESSORE 18mm (disponibile solo in tinta)**
BACK PANEL THICKNESS 18mm (available only in matching colour)

- **RIPIANI IN LEGNO (in tinta)**
WOOD SHELVES (in matching colour)

-1: Cielo e fondo folding
Folding top and bottom

-2: Fianchi folding
Folding side panels

-3: Ripiano
Shelf

-4: Schiena
Back panel

PROFONDITÀ "A" PER TUTTI I MODELLI CON ANTA Sp.18mm

DEPTH "A" FOR ALL MODELS WITH DOOR Th.18mm

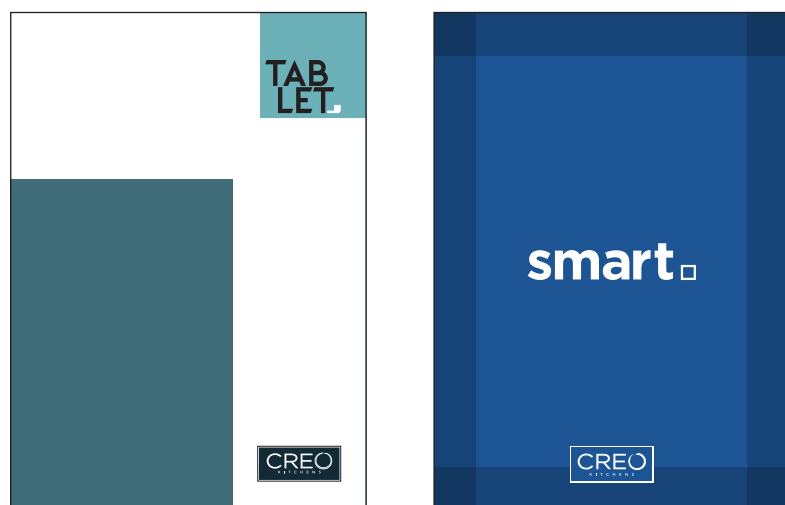

FINITURE DISPONIBILI
FINISHES AVAILABLE

PROFONDITÀ "B" PER TUTTI I MODELLI CON ANTA Sp.22mm

DEPTH "B" FOR ALL MODELS WITH DOOR Th.22mm



FINITURE DISPONIBILI
FINISHES AVAILABLE

DETTAGLIO PROFONDITÀ TERMINALI A GIORNO "ROW"
 "ROW" OPEN TERMINAL UNITS DEPTH DETAIL

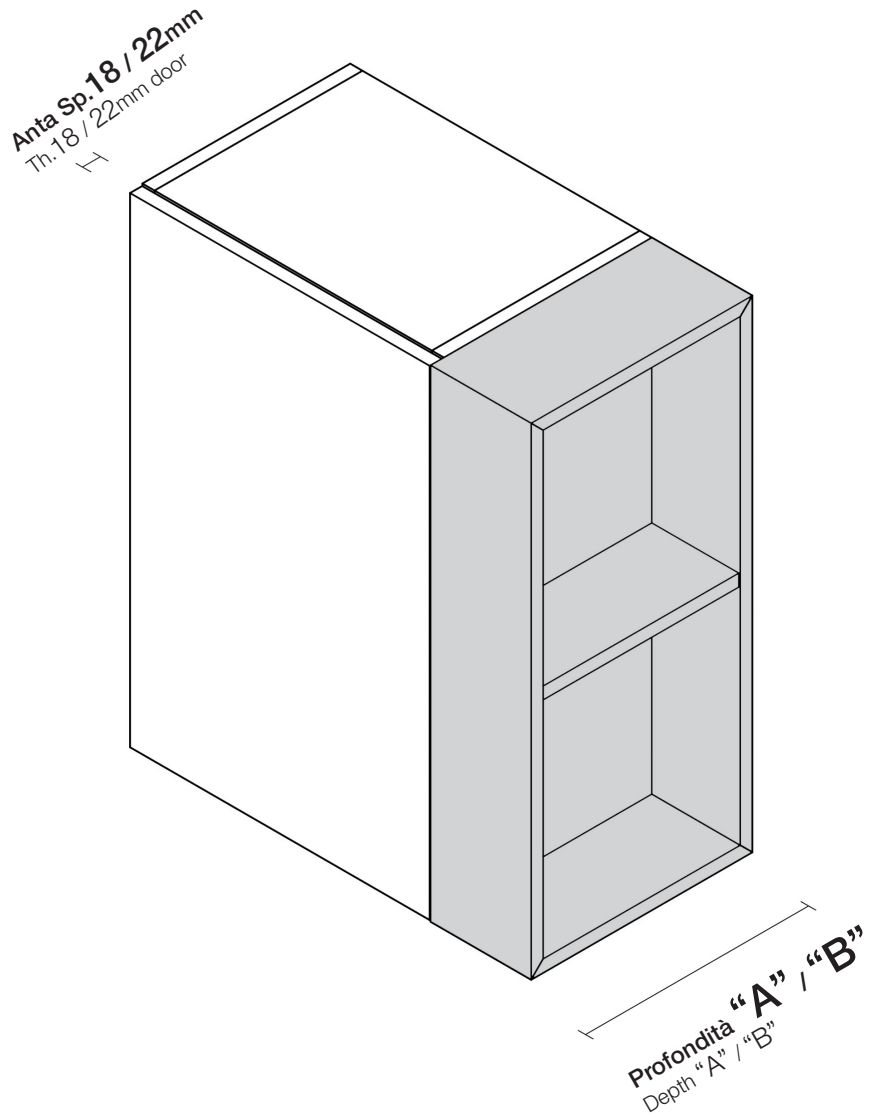

SEZIONE TECNICA TERMINALI A GIORNO "ROW"
 "ROW" OPEN TERMINAL UNITS TECHNICAL SECTION

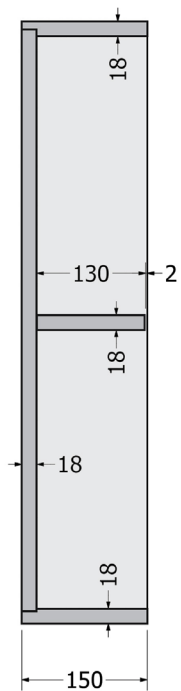

MOBILI A GIORNO TERMINALI L 15 "ROW"

"ROW" END OPEN UNITS W 15

N.B.: variante luce non disponibile

Note: light variant not available

N.B.: al codice indicato al listino, aggiungere alla fine la lettera che identifica la finitura

Note: to the code indicated in the price list, add the letter that identifies the finish at the end

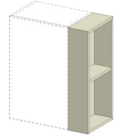
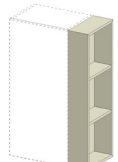
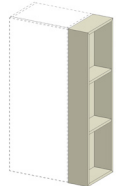
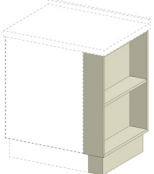
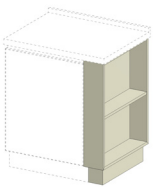
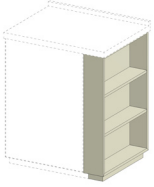
		MELAMINICI	LACCATO UV OPACO
		COD.	C L
 <p>terminale pensile H 72 2 vani end open wall unit H 72 2 compartments</p> <p>verso dx RH version</p>	A Prof.33	EJV072B0	
	B Prof.33,4	EJV072C0	
 <p>terminale pensile H 96 3 vani end open wall unit H 96 3 compartments</p> <p>verso dx RH version</p>	A Prof.33	EJV096B0	
	B Prof.33,4	EJV096C0	
 <p>terminale pensile H 108 3 vani end open wall unit H 108 3 compartments</p> <p>verso dx RH version</p>	A Prof.33	EJV108B0	
	B Prof.33,4	EJV108C0	
 <p>terminale base/isola H 72 2 vani end open base uni/island t H 72 2 compartments</p> <p>verso dx RH version</p>	A Prof.59,5 base	EJY072E0	
	B Prof.59,9 base	EJY072F0	
	A Prof.61,5 isola	EJY072H0	
	B Prof.62,3 isola	EJY072K0	
	A Prof.92,5 isola	EJY072M0	
	B Prof.93,3 isola	EJY072P0	
 <p>terminale base/isola H 75 2 vani end open base unit/island H 75 2 compartments</p> <p>verso dx RH version</p>	A Prof.59,5 base	EJY075E0	
	B Prof.59,9 base	EJY075F0	
	A Prof.61,5 isola	EJY075H0	
	B Prof.62,3 isola	EJY075K0	
	A Prof.92,5 isola	EJY075M0	
	B Prof.93,3 isola	EJY075P0	
 <p>terminale base/isola H 84 3 vani end open base unit/island H 84 3 compartments</p> <p>verso dx RH version</p>	A Prof.59,5 base	EJY084E0	
	B Prof.59,9 base	EJY084F0	
	A Prof.61,5 isola	EJY084H0	
	B Prof.62,3 isola	EJY084K0	
	A Prof.92,5 isola	EJY084M0	
	B Prof.93,3 isola	EJY084P0	

MOBILI A GIORNO TERMINALI L 15 "ROW"

"ROW" END OPEN UNITS W 15

N.B.: variante luce non disponibile

Note: light variant not available

N.B.: al codice indicato al listino, aggiungere alla fine la lettera che identifica la finitura

Note: to the code indicated in the price list, add the letter that identifies the finish at the end

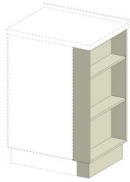
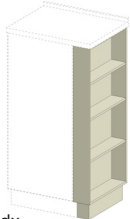
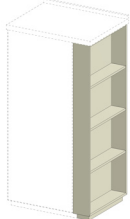
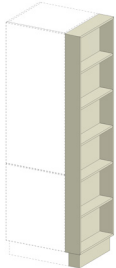
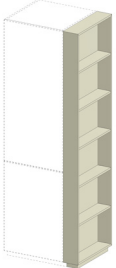
			MELAMINICI	LACCATO UV OPACO
		COD.	C	L
 <p>terminale colonna H 96 3 vani end open column H 96 3 compartments</p> <p>verso dx RH version</p>	A Prof.59,5	EJZ096E0		
	B Prof.59,9	EJZ096F0		
 <p>terminale colonna H 132 4 vani end open column H 132 4 compartments</p> <p>verso dx RH version</p>	A Prof.59,5	EJZ132E0		
	B Prof.59,9	EJZ132F0		
 <p>terminale colonna H 144 4 vani end open column H 144 4 compartments</p> <p>verso dx RH version</p>	A Prof.59,5	EJZ144E0		
	B Prof.59,9	EJZ144F0		
 <p>terminale colonna H 204 6 vani end open column H 204 6 compartments</p> <p>verso dx RH version</p>	A Prof.59,5	EJZ204E0		
	B Prof.59,9	EJZ204F0		
 <p>terminale colonna H 216 6 vani end open column H 216 6 compartments</p> <p>verso dx RH version</p>	A Prof.59,5	EJZ216E0		
	B Prof.59,9	EJZ216F0		

COLORI COME MODELLI LUBE

SAME COLOURS AS LUBE MODELS



COLORI COME MODELLI CREO

SAME COLOURS AS CREO MODELS

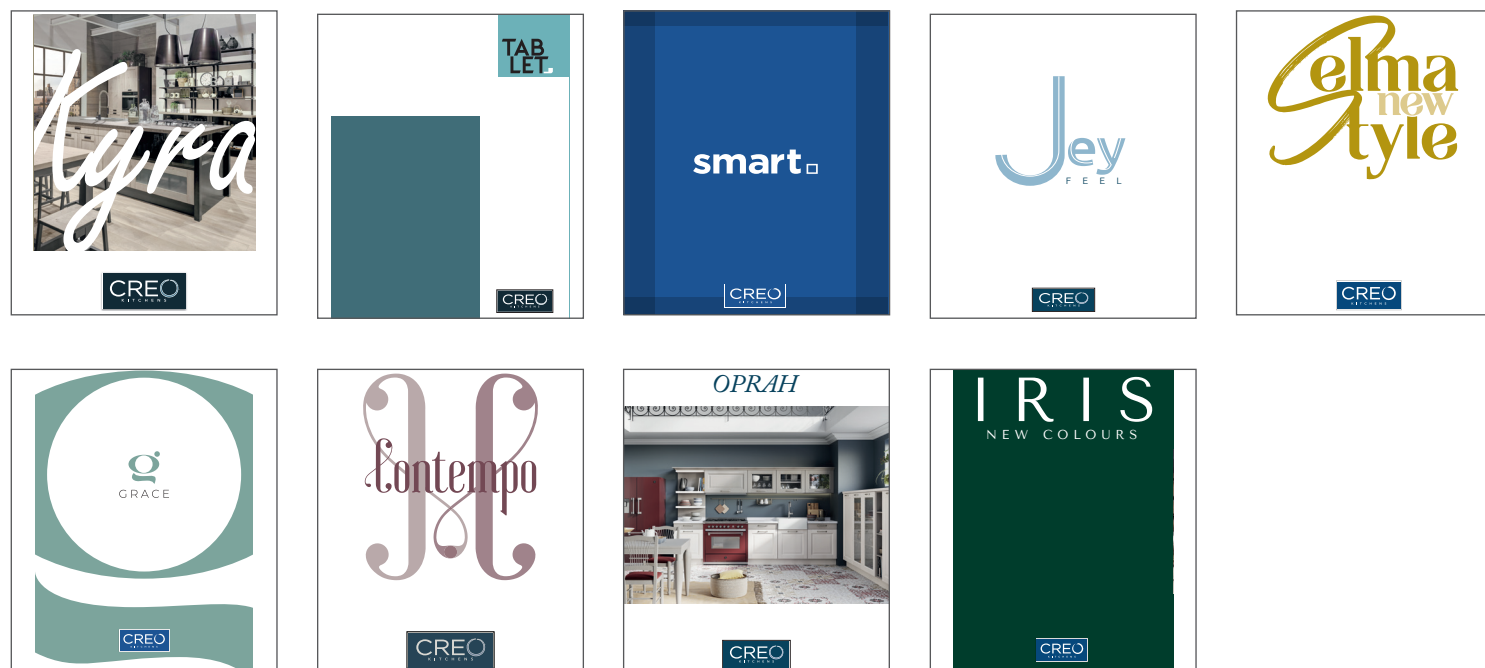

N.B.: gli elementi laccati UV nei modelli Immagina e Tablet possono essere solo realizzati nelle finiture laccate opache. nel modello Smart gli elementi possono essere solo realizzati nelle finiture alkorcell.

Note: the UV lacquered elements in the Immagina and Tablet models can only be made in matt lacquered finishes.
in the Smart model the elements can only be made in the alkorcell finishes.

N.B.: per essere sempre aggiornati sulla disponibilità delle finiture, consultare sempre l'extranet aziendale.

Note: To always be updated on the availability of finishes, always consult the company extranet.

COLORI COME STRUTTURA

SAME COLOURS AS CARCASS

bianco (opz.001) white	visone (opz.948M) mink	lavagna (opz.9620) slate grey	fango (opz.8860) mud	conchiglia (opz.8910) shell	argilla (opz.9690) clay
frassino bianco assoluto (opz.6050) absolute white ash	frassino bianco camelia (opz.6055) camelia white ash	frassino lino (opz.8919) linen ash	frassino cammello (opz.9485) camel ash		

COLORI SCHIENE

BACK PANELS COLOURS

N.B.: nelle finiture impiallacciate, laccate lucide e laccate opache le schiene si possono fare solo in tinta

Note: in the veneered, glossy lacquered and matt lacquered finishes the backs can only be made in the same color

IMPIALLACCIATI IMMAGINA WOOD IMMAGINA WOOD VENEERED

rovere naturale (opz.5442) natural oak	rovere grey (opz.5443) grey oak	rovere moscato (opz.5444) muscat oak	rovere fumè (opz.5445) smoked oak	rovere bianco (opz.5441) white oak	rovere nero (opz.5446) black oak
---	------------------------------------	---	--------------------------------------	---------------------------------------	-------------------------------------

MATHERA IMMAGINA IMMAGINA MATHERA

areia beige (opz.MT02) beige sand	areia grigio (opz.MT03) grey sand	areia nero (opz.MT04) black sand	gipso grigio (opz.MT23) grey gipso	gipso rosso (opz.MT24) red gipso	gipso verde (opz.MT22) green gipso
selce grigio chiaro (opz.MT13) light gray flint	selce nero (opz.MT14) black flint				

PET IMMAGINA IMMAGINA PET

metal brass (opz.8848) brass metal	metal brown (opz.8849) brown metal	metal dark night (opz.7871) night dark metal
---------------------------------------	---------------------------------------	---

LACCATI OPACHI UV IMMAGINA IMMAGINA UV MATT LACQUERED

bianco (opz.7405) white	bianco neve (opz.7407) snow white	desert (opz.8941) desert	polvere (opz.9529) dust	beige colorado (opz.7777) colorado beige	antracite (opz.9558) anthracite
nero (opz.7895) black	grigio minerale (opz.9523) mineral grey	blu cobalto (opz.8383) cobalt blue	verde malga (opz.8477) alpine green	rosso cammeo (opz.8160) cameo red	giallo cadmio (opz.8255) cadmio yellow
verde nilo (opz.8475) nilo green	rosso velvet (opz.8168) velvet red				

LACCATI OPACHI MATT LACQUERED



N.B.: vedi tabella laccati Gruppo Lube

Note: see Gruppo Lube lacquered table