



GRUPPO LUBE



SISTEMI D'ARREDO

FURNITURE SYSTEMS

CUCINE
LUBE

GRUPPO LUBE

CREO
KITCHENS

Multiplo





“MULTIPLO”
“MULTIPLO”



SISTEMA MODULARE “MULTIPLO”

MODULAR SYSTEM “MULTIPLO”

“MULTIPLO” è un sistema multifunzionale con struttura in alluminio, che permette la realizzazione di strutture a giorno. La versatilità del sistema e la sua semplicità consistono nella facilità di montaggio e nell'essenzialità dell'estetica, rendendolo perfetto per ogni ambiente.

“MULTIPLO” is a multifunctional system with aluminium structure, that allow to create opened structure solutions. The versatility and the simplicity of this project lay in the essential look and its easy to assemble nature, making it perfect for every space.



ESEMPIO DI VERSIONE LIBRERIA A PARETE CON KIT LUCE LED DUAL COLOR
EXAMPLE OF THE WALL BOOKCASE VERSION WITH DUAL COLOR LED LIGHT KIT

SISTEMA MODULARE "MULTIPLO"

MODULAR SYSTEM "MULTIPLO"

Disponibile in 4 VERSIONI DIFFERENTI

Available in 4 DIFFERENT VERSIONS

SOTTOPENSILE UNDER WALL UNIT



SOSPESO HANGING



LIBRERIA A PARETE WALL BOOKCASE



TERMINALE END UNIT



FINITURE DISPONIBILI PER STRUTTURA AVAILABLE STRUCTURE FINISHES



nero (opt.7892)
black (opt.7892)



silver dark (opt.9507)
dark silver (opt.9507)

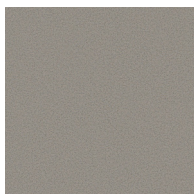

grigio selce (opt.SEL)
flint grey (opt.SEL)

**N.B.: PER IL MONTAGGIO CONSULTARE
L'APPOSITO LIBRETTO DI ISTRUZIONI**
NOTE: SEE INSTRUCTION MANUAL FOR ASSEMBLY

“MULTIPLO” SOTTOPENSILE

“MULTIPLO” UNDER WALL UNIT

Struttura modulare in alluminio con piastre per fissaggio a parete e installazione tra pensile e base. Completa di supporti e traversi orizzontali per aggancio di mensole disponibili in versione melaminico, laccato opaco e metallo.

Possibilità di inserire il kit luce led Dual Color con telecomando nella parte posteriore dei montanti.

Disponibile nelle larghezze L 60-90 cm e nell'altezza H 36 cm. Portata massima 20 kg (per ogni mensola).

Modular aluminium wall-mounted structure with plates for the placement between wall unit and base unit.

Included supports and horizontal beams for melamine, matt lacquered and metal shelves.

Possibility to insert Dual Color led light kit with remote control in the rear of pillars.

Available in widths W 60-90 cm and in height H 36 cm. Load capacity 20 kg (for each shelf).

VISTA FRONTALE
FRONT VIEW

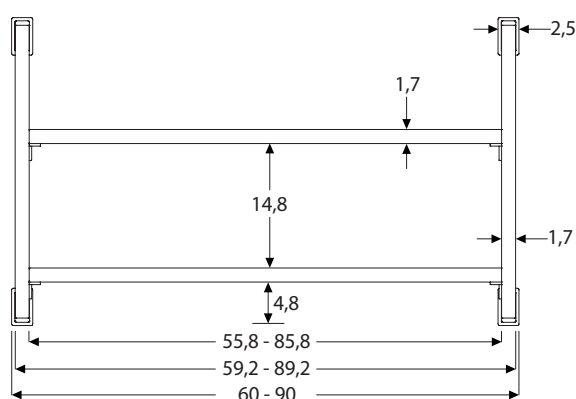

VISTA LATERALE
SIDE VIEW

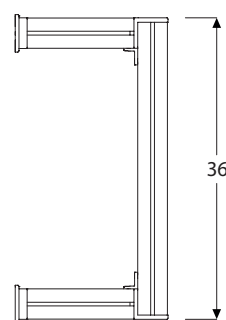

VISTA SUPERIORE
TOP VIEW

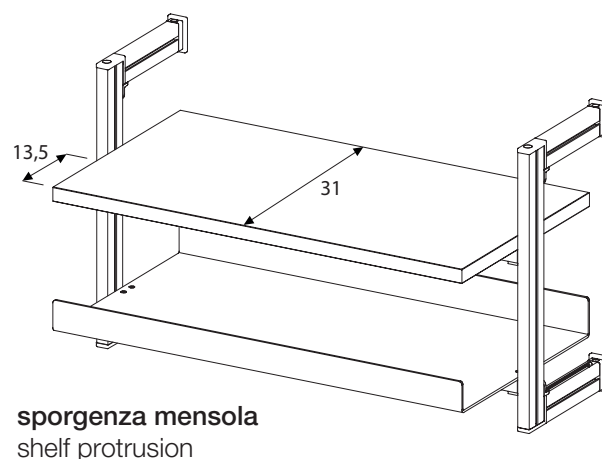
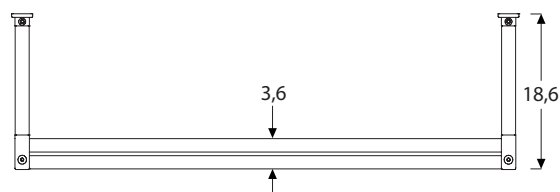

Disponibili mensole in melaminico/laccato opaco e in metallo di L 55,8 e L 85,8 P 31 cm (vedi pag.12). Per schema montanti con kit luce led Dual Color e alimentatori (vedi pag.13).

Available melamine/matt lacquered and metal shelves W 55,8 and W 85,8 D 31 cm (see page 12).

Diagram pillars with Dual Color led light kit and power supplies (see page 13).

“MULTIPLO” SOTTOPENSILE

“MULTIPLO” UNDER WALL UNIT

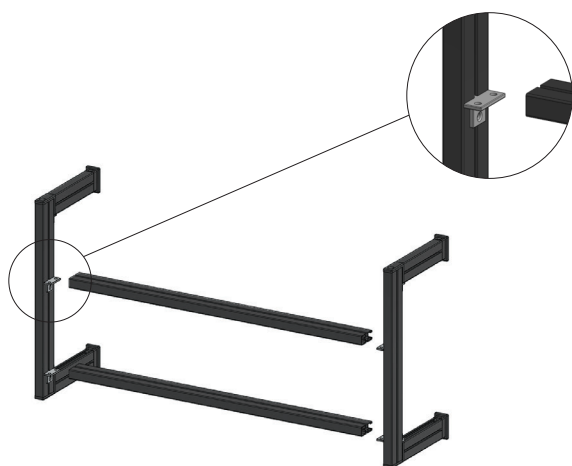

- Struttura singola composta da:**
- montante sx con supporti e traversi orizzontali nr.2 per H 36
 - montante dx con supporti (per fine composizione)
- Single structure consist of:
- LH pillar with supports and horizontal beams nr.2 for H 36
 - RH pillar with supports (for end composition)

H 36 L 60 08902401
H 36 L 90 08902403

Magg. kit luce led Dual Color (per 2 montanti)
Surcharge led light kit Dual Color (for 2 pillars) H
36 opz.002

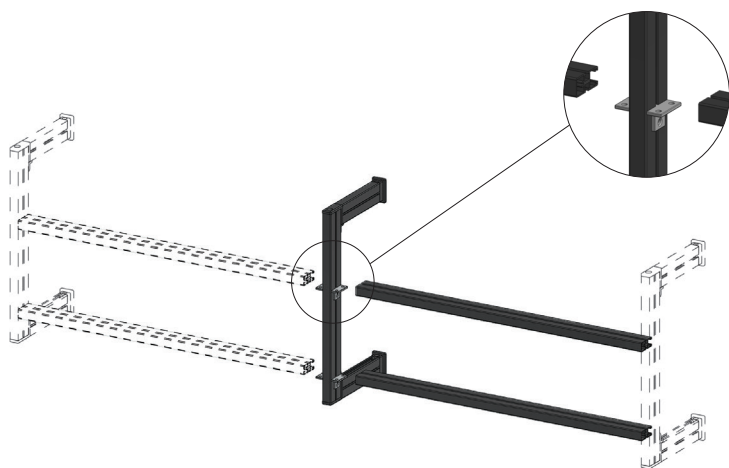

- Struttura centrale composta da:**
- montante centrale con supporti e traversi orizzontali nr.2 per H 36
- Central structure consist of:
- central pillar with supports and horizontal beams nr.2 for H 36

H 36 L 57,9 08902401C
H 36 L 87,9 08902403C

Magg. kit luce led Dual Color (per 1 montante)
Surcharge led light kit Dual Color (for 1 pillar)
H 36 opz.002

Per esempi di modularità vedi pag. 18-20.

N.B.: nella realizzazione di composizioni con struttura singola e centrale il montante dx deve essere sempre spostato a fine composizione.

(ACCESSORIO PORTABOTTIGLIE NON DISPONIBILE)

For modularity examples see page 18-20.

Note: RH pillar must always be moved at the end of the composition when there are single and central structures
(BOTTLES RACK ACCESSORY NOT AVAILABLE)

“MULTIPLO” SOSPESO

“MULTIPLO” HANGING

Struttura modulare in alluminio con piastre per fissaggio a parete. Completa di supporti e traversi orizzontali per aggancio di mensole disponibili in versione melaminico, laccato opaco e metallo. Possibilità di inserire il kit luce led Dual Color con telecomando nella parte posteriore dei montanti. Disponibile nelle larghezze L 60-90 cm e nelle altezze H 108-180 cm.

Portata massima 20 kg (per ogni mensola).

Modular aluminium wall-mounted structure with plates. Included supports and horizontal beams for melamine, matt lacquered and metal shelves. Possibility to insert Dual Color led light kit with remote control in the rear of pillars. Available in widths W 60-90 cm and in heights H 108-180 cm. Load capacity 20 kg (for each shelf).

VISTA FRONTALE
FRONT VIEW

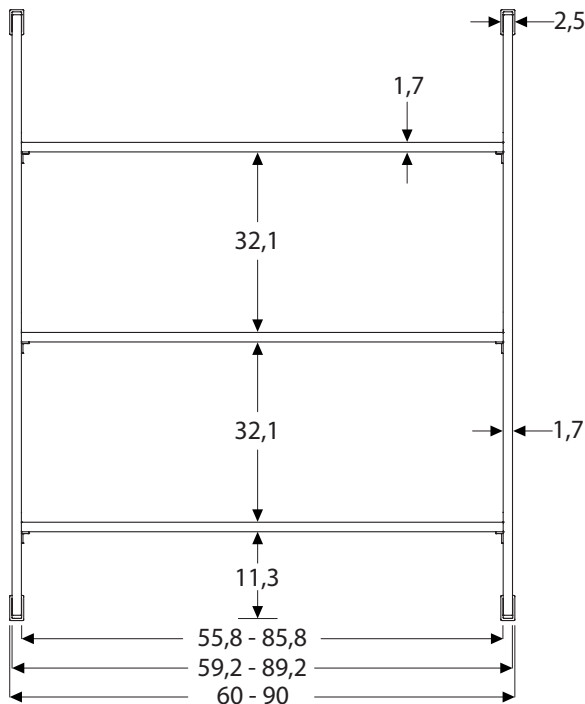

VISTA LATERALE
SIDE VIEW

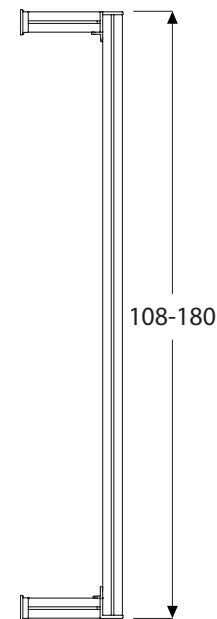

VISTA SUPERIORE
TOP VIEW

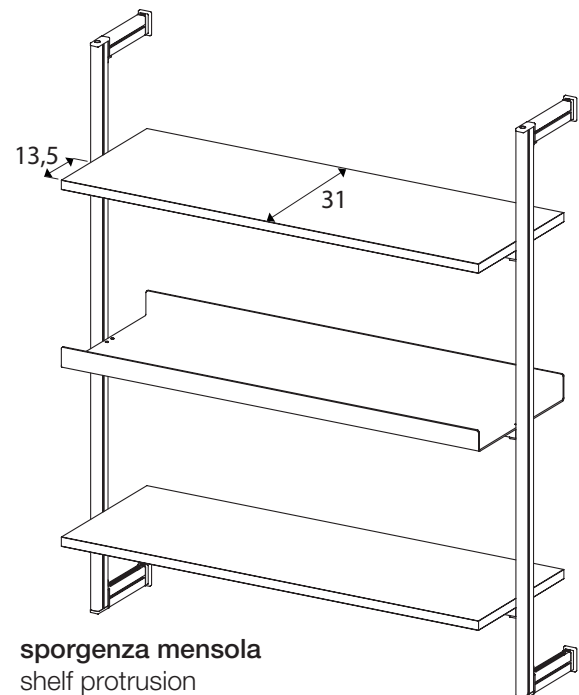
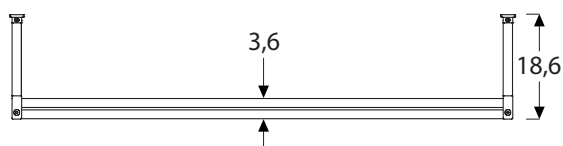

Disponibili mensole in melaminico/laccato opaco e in metallo di L 55,8 e L 85,8 P 31 cm (vedi pag.12). Per schema montanti con kit luce led Dual Color e alimentatori (vedi pag.13).

Available melamine/matt lacquered and metal shelves W 55,8 and W 85,8 D 31 cm (see page 12).

Diagram pillars with Dual Color led light kit and power supplies (see page 13).

“MULTIPLO” SOSPESO

“MULTIPLO” HANGING

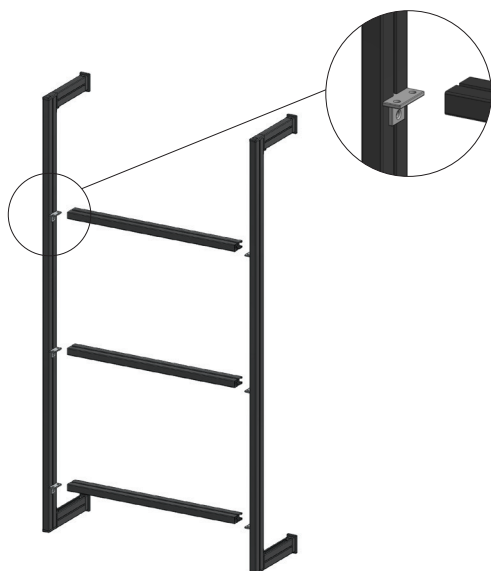

Struttura singola composta da:

- montante sx con supporti e traversi orizzontali
nr.3 per H 108
nr.5 per H 180
- montante dx con supporti (per fine composizione)

Single structure consist of:

- LH pillar with supports and horizontal beams
nr.3 for H 108
nr.5 for H 180
- RH pillar with supports (for end composition)

H 108 L 60 08902405

H 108 L 90 08902407

H 180 L 60 08902411

H 180 L 90 08902413

Magg. kit luce led Dual Color (per 2 montanti)

Surcharge led light kit Dual Color (for 2 pillars)

H 108 opz.002

H 180 opz.002

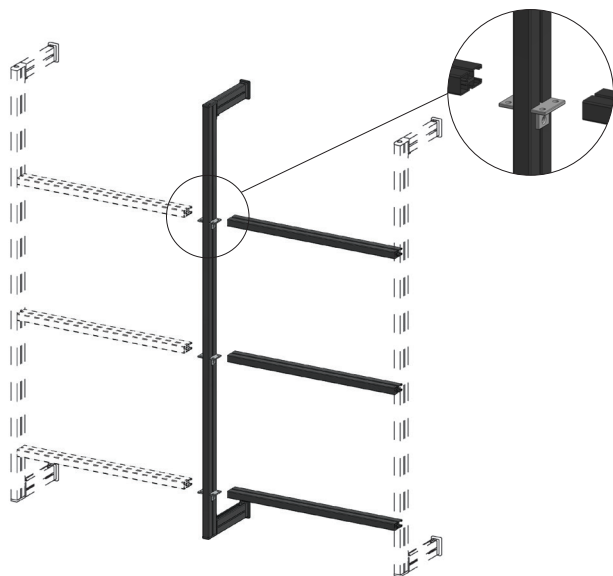

Struttura centrale composta da:

- montante centrale con supporti e traversi orizzontali
nr.3 per H 108
nr.5 per H 180

Central structure consist of:

- central pillar with supports and horizontal beams
nr.3 for H 108
nr.5 for H 180

H 108 L 57,9 08902405C

H 108 L 87,9 08902407C

H 180 L 57,9 08902411C

H 180 L 87,9 08902413C

Magg. kit luce led Dual Color (per 1 montante)

Surcharge led light kit Dual Color (for 1 pillar)

H 108 opz.002

H 180 opz.002

Per esempi di modularità vedi pag. 18-20.

N.B.: nella realizzazione di composizioni con struttura singola e centrale il montante dx deve essere sempre spostato a fine composizione.

For modularity examples see page 18-20.

Note: RH pillar must always be moved at the end of the composition when there are single and central structures

“MULTIPLO” LIBRERIA A PARETE

“MULTIPLO” WALL BOOKCASE

Struttura modulare in alluminio con appoggio a terra e piastre per fissaggio a parete. Completa di supporti e traversi orizzontali per aggancio di mensole disponibili in versione melaminico, laccato opaco e metallo. Possibilità di inserire il kit luce led Dual Color con telecomando nella parte posteriore dei montanti. Disponibile nelle larghezze L 60-90 cm e nelle altezze H 217-222 cm. Portata massima 20 kg (per ogni mensola).
Modular ground aluminium structure with plates for fixing to wall. Included supports and horizontal beams melamine, matt lacquered and metal shelves. Possibility to insert Dual Color led light kit with remote control in the rear of pillars. Available in widths W 60-90 cm and in heights H 217-222 cm. Load capacity 20 kg (for each shelf).

VISTA FRONTALE
FRONT VIEW

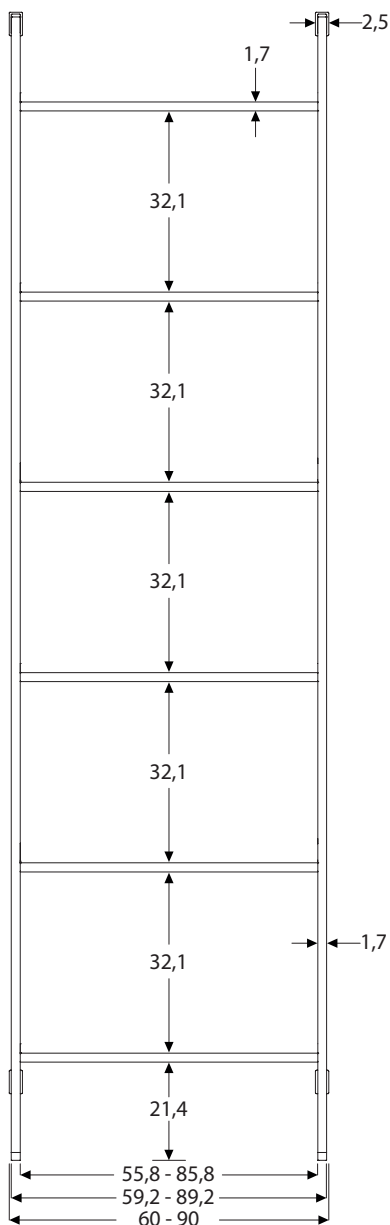

VISTA LATERALE
SIDE VIEW

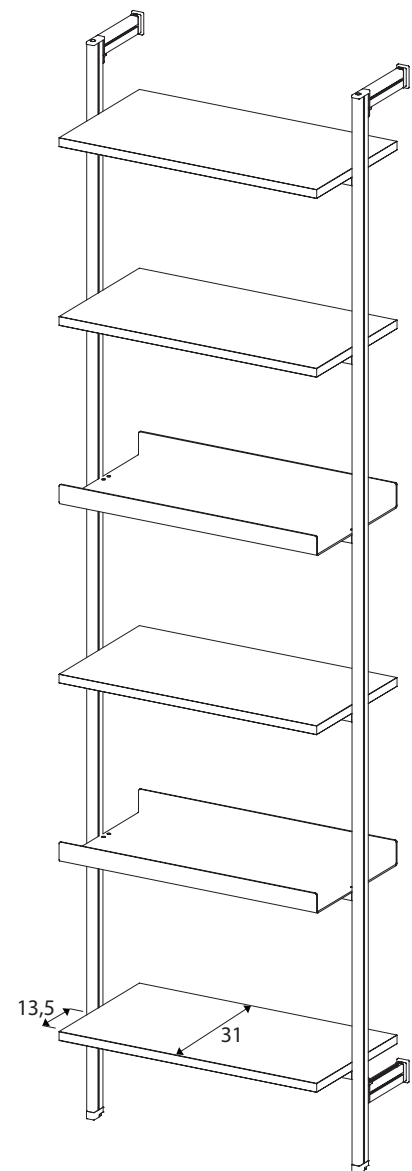
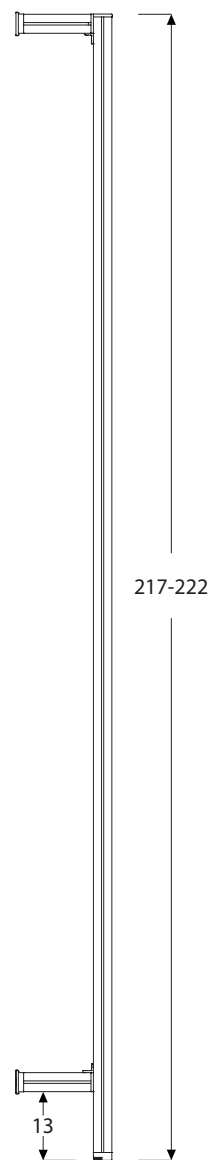

sporgenza mensola
shelf protrusion

VISTA SUPERIORE
TOP VIEW

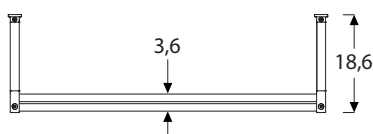

Disponibili mensole in melaminico/laccato opaco e in metallo di L 55,8 e L 85,8 P 31 cm (vedi pag.12).
Per schema montanti con kit luce led Dual Color e alimentatori (vedi pag.13).
Available melamine/matt lacquered and metal shelves W 55,8 and W 85,8 D 31 cm (see page 12).
Diagram pillars with Dual Color led light kit and power supplies (see page 13).

“MULTIPLO” LIBRERIA A PARETE

“MULTIPLO” WALL BOOKCASE

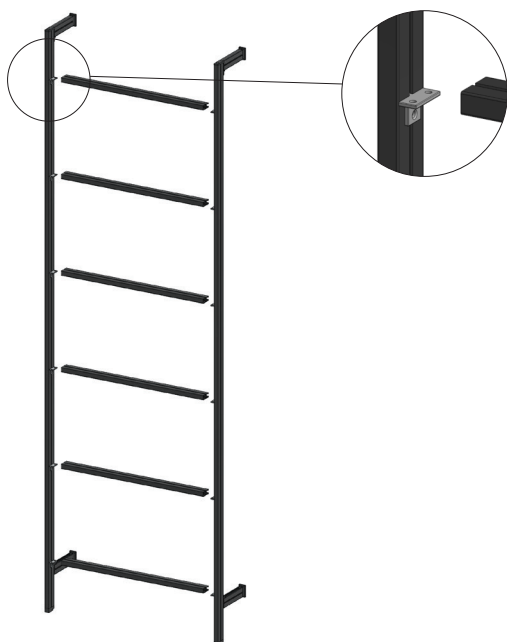

Struttura singola composta da:

- montante sx con supporti e traversi orizzontali
nr.6 per H 217
nr.6 per H 222

- montante dx con supporti (per fine composizione)

Single structure consist of:

- LH pillar with supports and horizontal beams
nr.6 for H 217
nr.6 for H 222
- RH pillar with supports (for end composition)

H 217 L 60 08902421

H 217 L 90 08902423

H 222 L 60 08902425

H 222 L 90 08902427

Magg. kit luce led Dual Color (per 2 montanti)

Surcharge led light kit Dual Color (for 2 pillars)

H 217 opz.002

H 222 opz.002

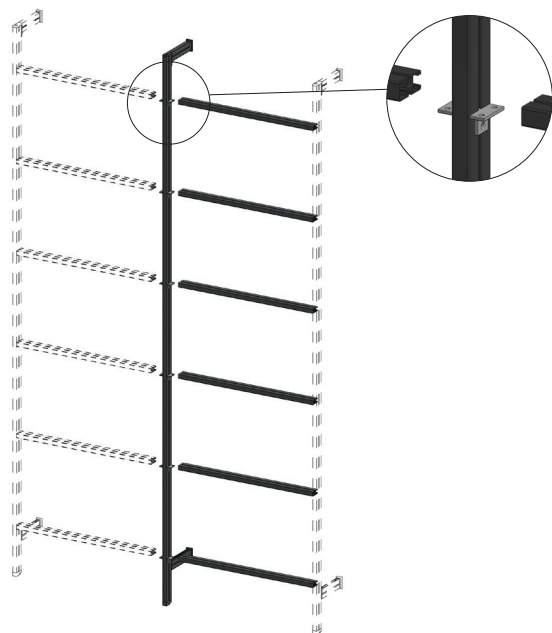

Struttura centrale composta da:

- montante centrale con supporti e traversi orizzontali
nr.6 per H 217
nr.6 per H 222

Central structure consist of:

- central pillar with supports and horizontal beams
nr.6 for H 217
nr.6 for H 222

H 217 L 57,9 08902421C

H 217 L 87,9 08902423C

H 222 L 57,9 08902425C

H 222 L 87,9 08902427C

Magg. kit luce led Dual Color (per 1 montante)

Surcharge led light kit Dual Color (for 1 pillar)

H 217 opz.002

H 222 opz.002

Per esempi di modularità vedi pag. 18-20.

N.B.: nella realizzazione di composizioni con struttura singola e centrale il montante dx deve essere sempre spostato a fine composizione.

For modularity examples see page 18-20.

Note: RH pillar must always be moved at the end of the composition when there are single and central structures

“MULTIPLO” TERMINALE

“MULTIPLO” END UNIT

Struttura singola in alluminio con piastre per fissaggio su fianco base/colonna e installazione a fine composizione. Completa di supporti e traversi orizzontali per aggancio di mensole disponibili in versione melaminico, laccato opaco e metallo. Disponibile nella larghezza L 45 cm e nelle altezze H 60-108-180 cm.

Portata massima 20 kg (per ogni mensola). **NON MODULABILE.**

Single aluminium structure mounted on side of the base unit/column at the end of the composition.

Included supports and horizontal beams for melamine, matt lacquered and metal shelves.

Available in width W 45 cm and in heights H 60-108-180 cm. Load capacity 20 kg (for each shelf). **NOT ADJUSTABLE.**

VISTA FRONTALE
FRONT VIEW

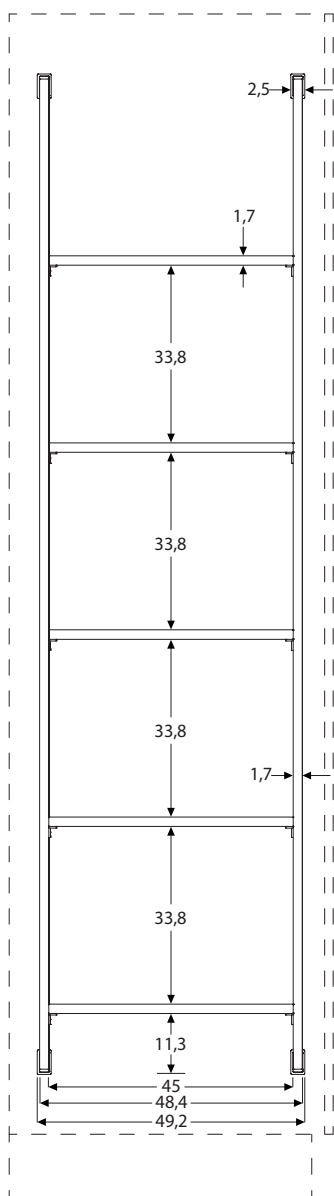

VISTA LATERALE
SIDE VIEW

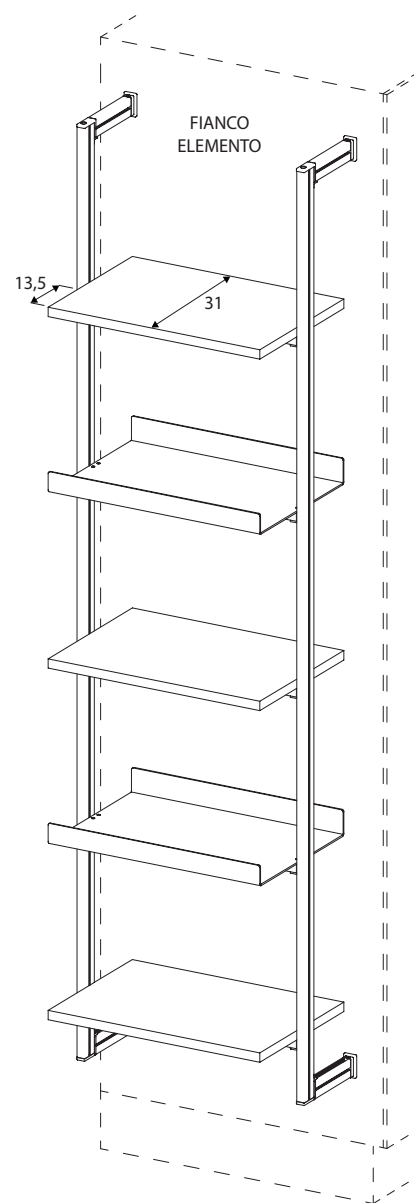
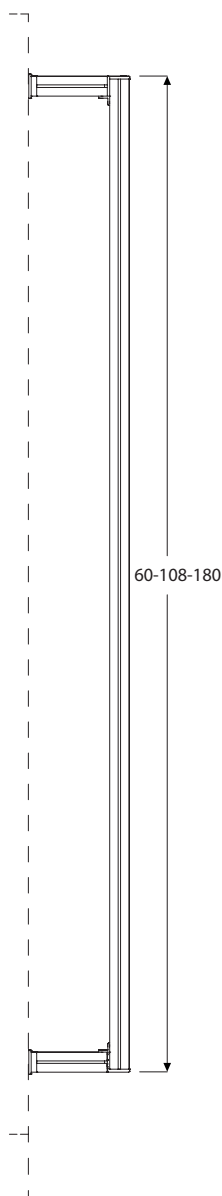

sporgenza mensola
shelf protrusion

VISTA SUPERIORE
TOP VIEW

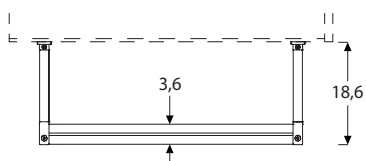

Disponibili mensole in melaminico/laccato opaco e in metallo di L 45 P 31 cm (vedi pag.12).

N.B.: KIT LUCE LED E ACCESSORIO PORTABOTTIGLIE NON DISPONIBILE

Available melamine/matt lacquered and metal shelves W 41 D 31 cm (see page 12).

Note: LED LIGHT KIT AND BOTTLES RACK ACCESSORY NOT AVAILABLE

“MULTIPLO” TERMINALE

“MULTIPLO” END UNIT

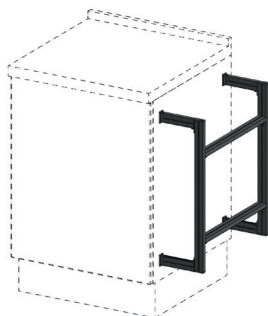

Struttura singola H 60 L 45 composta da:

- montante sx con supporti
- 2 traversi orizzontali
- montante dx con supporti

Single structure H 60 W 45 consist of:

- LH pillar with supports
- 2 horizontal beams
- RH pillar with supports

H 60 L 45 08902260

Per basi H 72/75/84
For base units H 72/75/84

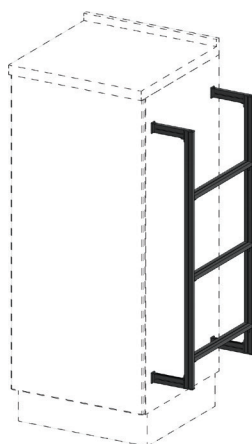

Struttura singola H 108 L 45 composta da:

- montante sx con supporti
- 3 traversi orizzontali
- montante dx con supporti

Single structure H 108 W 45 consist of:

- LH pillar with supports
- 3 horizontal beams
- RH pillar with supports

H 108 L 45 08902263

Per colonne H 132/144
For columns H 132/144

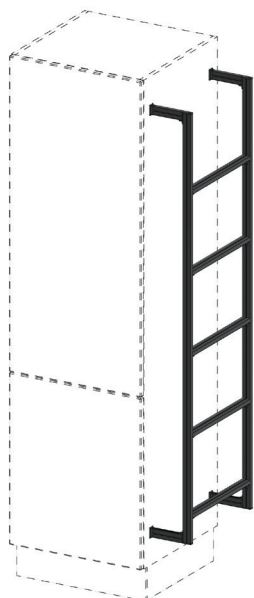

Struttura singola H 180 L 45 composta da:

- montante sx con supporti
- 5 traversi orizzontali
- montante dx con supporti

Single structure H 180 W 45 consist of:

- LH pillar with supports
- 5 horizontal beams
- RH pillar with supports

H 180 L 45 08902265

Per colonne H 204/216
For columns H 204/216

“MULTIPLO” ACCESSORI

“MULTIPLO” ACCESSORIES

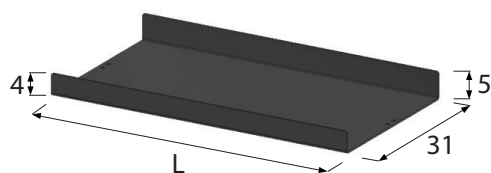

Mensola in metallo P 31 SP.2 mm verniciata a polvere
Metal shelf D 31 th.2 mm powder painted

L 45 08902374
L 55,8 08902375
L 85,8 08902378

Finiture disponibili

Available finishes



nero (opz.7892)
black (opt.7892)

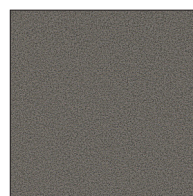

silver dark (opz.9507)
dark silver (opt.9507)

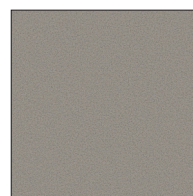

grigio selce (opz.SEL)
flint grey (opt.SEL)

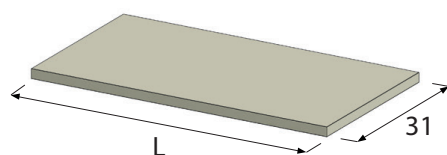

Mensola P 31 SP.18 mm finitura come anta

N.B.: per le finiture vedi pag.14-17

Shelf D 31 th.18 mm same finish as door

Note: for the finishes see page 14-17

MELAMINICO

MELAMINE

L 45 08902384
L 55,8 08902385
L 85,8 08902388

LACCATO OPACO

MATT LACQUERED

L 45 08902394
L 55,8 08902395
L 85,8 08902398

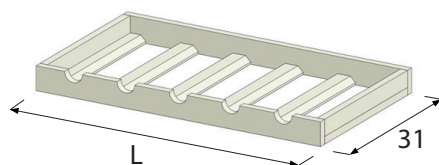

Portabottiglie in legno P 31 laccato a poro aperto
(completo di reggimensola a gradi)

Wood bottles rack D 31 open-pore lacquer
(complete with degree shelf brackets)

L 55,8 08902295
L 85,8 08902298

Finiture disponibili

Available finishes



nero (opz.7892)
black (opt.7892)

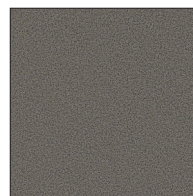

silver dark (opz.9507)
dark silver (opt.9507)



grigio selce (opz.SEL)
flint grey (opt.SEL)

“MULTIPL0” PROFILI LED DUAL COLOR PER MONTANTI

“MULTIPL0” DUAL COLOR LED PROFILES FOR PILLARS

Montanti SOTTOPENSILE

Pillars UNDER WALL UNIT

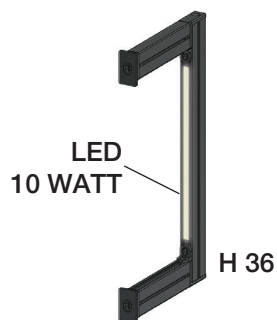

Montanti LIBRERIA A PARETE

Pillars WALL BOOKCASE

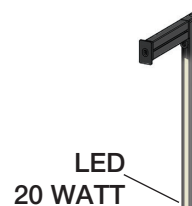
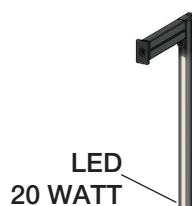

Montanti SOSPESO

Pillars HANGING

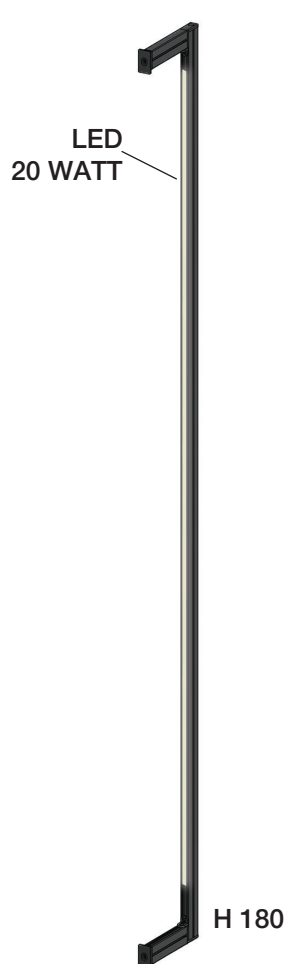
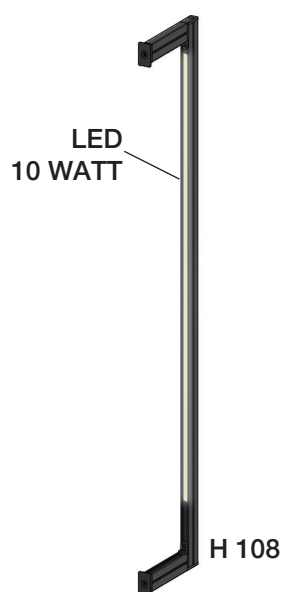

KIT ALIMENTATORI con telecomando e staffa/POWER SUPPLIES KIT with remote control and bracket



(max.4 ingressi)
(max.4 input)

Mercato UE/UE Market
- 30 WATT 08902350
- 100 WATT 08902351

Mercato Globale/Global Market
- 30 WATT 08902352
- 100 WATT 08902353

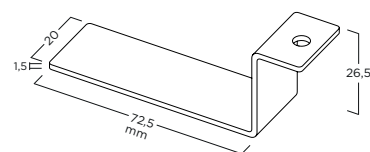

Staffa per alimentatore
(fissaggio sottomensola)
Bracket for power supply
(fixing on the bottom of the shelf)

“MULTIPLO” FINITURE MENSOLE SP.18 MM

“MULTIPLO” SHELVES FINISHES TH.18 MM

FINITURE MELAMINICHE - MELAMINE FINISHES

IMMAGINA PLUS



cansiglio bianco
(opz.1561)
white cansiglio



cansiglio terra bruciata
(opz.1562)
scorched earth cansiglio



cansiglio grigio fumo
(opz.1563)
smoke grey cansiglio



cansiglio sabbia
(opz.1564)
sand cansiglio



cansiglio champagne
(opz.1565)
champagne cansiglio



larice baglia
(opz.1826)
baglia larch



larice laguna
(opz.1827)
lagoon larch

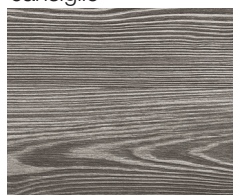

larice vulcano
(opz.1828)
volcano larch



larice terra
(opz.1829)
earth larch



noce
(opz.2363)
walnut



cemento
(opz.9633)
cement



bianco cristallo
(opz.7445)
cristal white

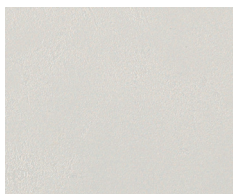

grigio nebbia
(opz.9626)
fog grey



castoro
(opz.8862)
beaver

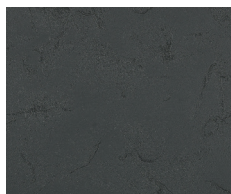

lavagna
(opz.9627)
slate grey



juta
(opz.8863)
jute



bianco assoluto
(opz.7441)
absolute white

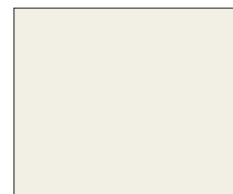

bianco neve
(opz.750)
snow white



grigio sasso
(opz.9650)
pebble grey



verde marino
(opz.8402)
sea green



grigio monzone
(opz.9651)
monsoon grey



grigio notte
(opz.9652)
midnight grey



grigio velo
(opz.9653)
veil grey

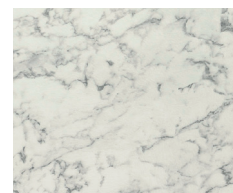

marmo baron
(opz.9632)
baron marble

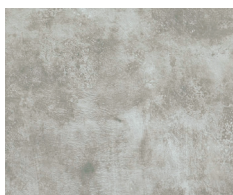

nichel
(opz.9660)
nickel

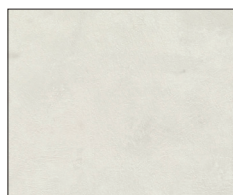

platino
(opz.9661)
platinum



zinco
(opz.9662)
zinc



peltro
(opz.9666)
pewter



titanio
(opz.9665)
titanium



olmo bianco
(opz.5001)
white elm



olmo antracite
(opz.5004)
anthracite elm



oak miele
(opz.1361)
honey oak



oak neve
(opz.1362)
snow oak



oak cognac
(opz.1363)
cognac oak

"MULTIPLO" FINITURE MENSOLE SP.18 MM

"MULTIPLO" SHELVES FINISHES TH.18 MM

FINITURE MELAMINICHE - MELAMINE FINISHES

UNICA



phagos nuvola
(opz.1567)
phagos cloud



phagos bianco
(opz.1566)
phagos white

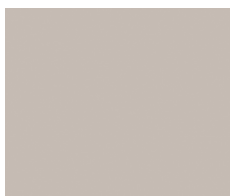

dove grey
(opz.8971)
grey dove



phagos kapok
(opz.1560)
phagos kapok



rovere perla
(opz.5314)
pearl oak



pietra grey
(opz.9642)
stone grey



ecru
(opz.9641)
ecru



antracite
(opz.9643)
anthracite



bianco assoluto
(opz.7450)
absolute white

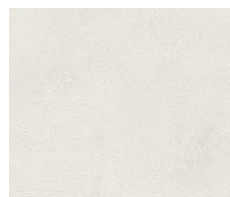

platino
(opz.9661)
platinum



phagos vulcano
(opz.1568)
phagos volcano



pietra fulvus
(opz.8867)
stone fulvus

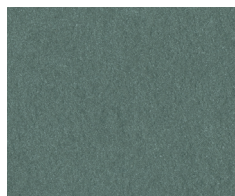

pietra musk
(opz.8403)
stone musk

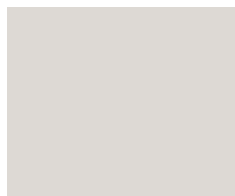

grigio chiaro
(opz.9640)
clear grey

“MULTIPLO” FINITURE MENSOLE SP.18 MM

“MULTIPLO” SHELVES FINISHES TH.18 MM

FINITURE MELAMINICHE - MELAMINE FINISHES

TABLET



rovere luna
(opz.5316)
moon oak



rovere venere
(opz.5315)
venus oak



rovere arizona
(opz.5317)
arizona oak



rovere dark
(opz.5318)
dark oak



frassino lava
(opz.2408)
lava ash



frassino sabbia
(opz.2406)
sand ash



frassino pietra
(opz.2407)
stone ash



noce brown
(opz.2371)
brown walnut

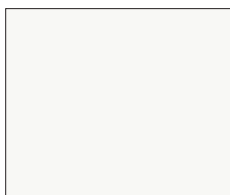

bianco
(opz.7447N)
white

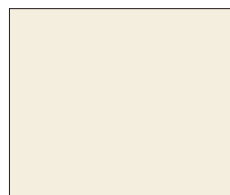

porcellana
(opz.7703N)
porcelain



desert
(opz.8914N)
desert



molara
(opz.9636N)
molara



arena
(opz.9637N)
arena



bianco
(opz.9639)
white



bronzo
(opz.8866)
bronze



ardesia
(opz.9638)
slate grey



rovere tabià
(opz.5309)
tabià oak



rovere ortisei
(opz.5305)
ortisei oak



trani
(opz.7704)
trani

“MULTIPLO” FINITURE MENSOLE SP.18 MM

“MULTIPLO” SHELVES FINISHES TH.18 MM

FINITURE MELAMINICHE - MELAMINE FINISHES

JEY FEEL



rovere silver
(opz.5306)
silver oak



rovere diamond
(opz.5307)
diamond oak



rovere tabià
(opz.5309)
tabià oak



rovere ortisei
(opz.5305)
ortisei oak



trani
(opz.7704)
trani

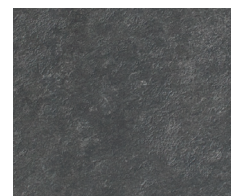

black
(opz.7863)
black

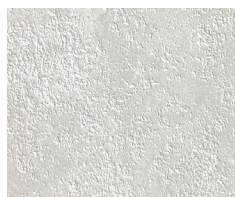

white
(opz.7448)
white



grigio agata
(opz.9623)
agata grey

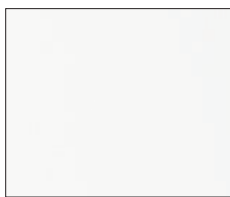

bianco assoluto
(opz.7441)
absolute white



grigio inox
(opz.9624)
stainless steel grey

SMART



frassino bianco alpino
(opz.2310)
alpine-white ash



rovere greige
(opz.2320)
greige oak



betulla
(opz.2311)
birch

FINITURE LACCATE OPACHE - MATT LACQUERED FINISHES

Disponibili tutti i colori opachi del catalogo FINITURE LACCATE (GRUPPO LUBE)
Available all matt colours of the LACQUERED FINISHES catalogue (GRUPPO LUBE)

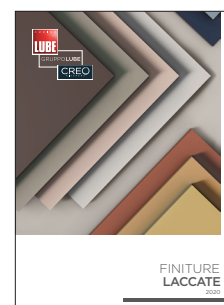

“MULTIPLO” ESEMPI DI COMPONENTABILITÀ

“MULTIPLO” EXAMPLES OF MODULARITY

ESEMPIO “MULTIPLO SOTTOPENSILE H 36 L 205”

EXAMPLE “MULTIPLO UNDER WALL UNIT H 36 W 205”

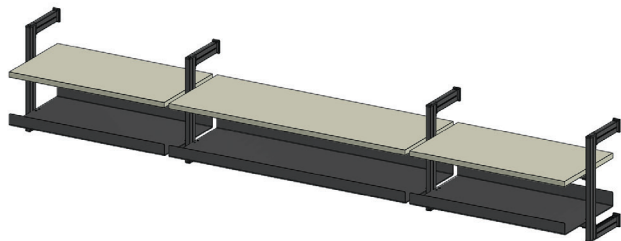

- **1 struttura singola H 36 L 60** 08902401
1 single structure H 36 W 60
- **1 struttura centrale H 36 L 87,9** 08902403C
1 central structure H 36 W 87,9
- **1 struttura centrale H 36 L 57,9** 08902401C
1 central structure H 36 W 57,9
- **2 mensole in melaminico P 31 L 55,8** 08902385
2 melamine shelves D 31 W 55,8
- **1 mensola in melaminico P 31 L 85,8** 08902388
1 melamine shelf D 31 W 85,8
- **2 mensole in alluminio P 31 L 55,8** 08902375
2 aluminium shelves D 31 W 55,8
- **1 mensola in alluminio P 31 L 85,8** 08902378
1 aluminium shelf D 31 W 85,8
- **Kit alimentatore 100 Watt (mercato UE)** 08902351
Power suppli kit 100 Watt (UE Market)
- **Maggiorazione kit luce led Dual Color** opz.002
Surcharge led light kit Dual Color

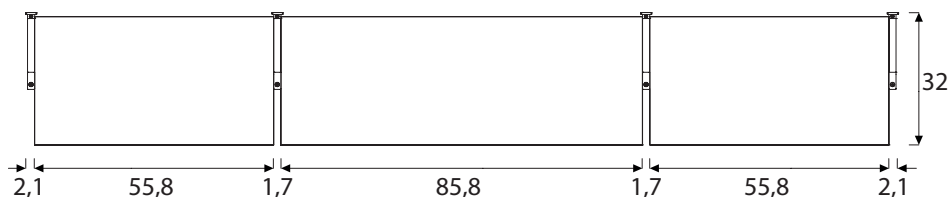

ESEMPIO “MULTIPLO SOSPESO H 108 L 117,5”

EXAMPLE “MULTIPLO HANGING H 108 W 117,5”

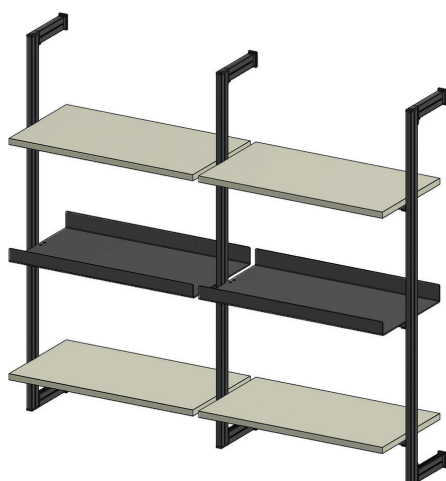

- **1 struttura singola H 108 L 60** 08902405
1 single structure H 108 W 60
- **1 struttura centrale H 108 L 57,9** 08902405C
1 central structure H 108 W 57,9
- **4 mensole in melaminico P 31 L 55,8** 08902385
4 melamine shelves D 31 W 55,8
- **2 mensole in alluminio P 31 L 55,8** 08902375
2 aluminium shelves D 31 W 55,8
- **Kit alimentatore 30 Watt (mercato UE)** 08902350
Power suppli kit 30 Watt (UE Market)
- **Maggiorazione kit luce led Dual Color** opz.002
Surcharge led light kit Dual Color

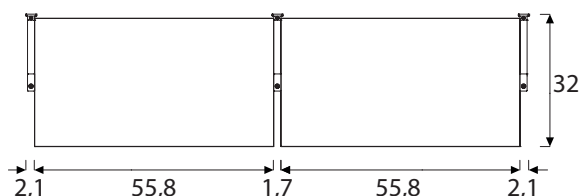

“MULTIPLO” ESEMPI DI COMPONENTABILITÀ

“MULTIPLO” EXAMPLES OF MODULARITY

ESEMPIO “MULTIPLO LIBRERIA A PARETE H 217 L 235”

EXAMPLE “MULTIPLO WALL BOOKCASE H 217 W 235”

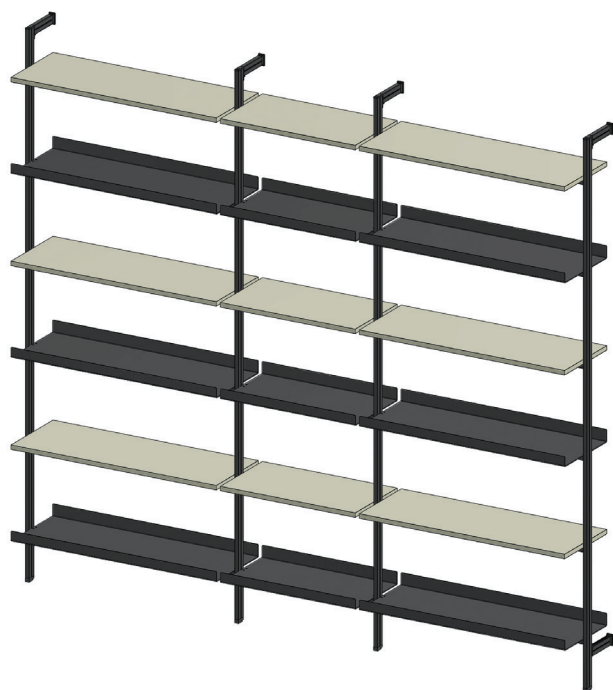

- **1 struttura singola H 217 L 90** 08902423
1 single structure H 217 W 90
- **1 struttura centrale H 217 L 57,9** 08902421C
1 central structure H 217 W 57,9
- **1 struttura centrale H 217 L 87,9** 08902423C
1 central structure H 217 W 87,9
- **6 mensole in melaminico P 31 L 85,8** 08902388
6 melamine shelves D 31 W 85,8
- **3 mensole in melaminico P 31 L 55,8** 08902385
3 melamine shelves D 31 W 55,8
- **6 mensole in alluminio P 31 L 85,8** 08902378
6 aluminium shelves D 31 W 85,8
- **3 mensole in alluminio P 31 L 55,8** 08902375
3 aluminium shelves D 31 W 55,8
- **Kit alimentatore 100 Watt (mercato UE)** 08902351
Power suppli kit 100 Watt (UE Market)
- **Maggiorazione kit luce led Dual Color** opz.002
Surcharge led light kit Dual Color

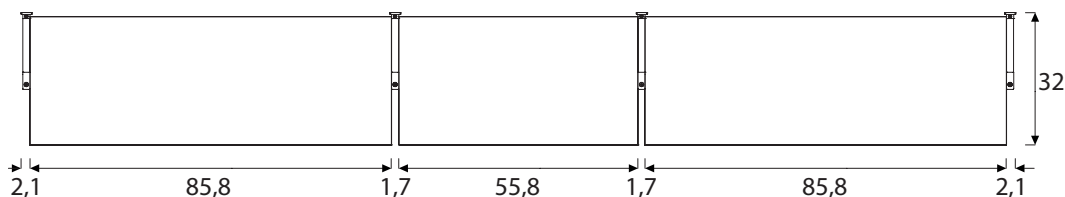

ESEMPIO “MULTIPLO TERMINALE H 180 L 49,2” per colonna H 204

EXAMPLE “MULTIPLO END UNIT H 180 W 49,2” for column H 204

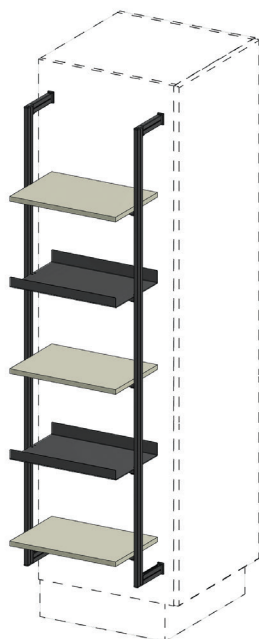

- **1 struttura terminale H 180 L 45** 08902265
1 end structure H 180 W 45
- **3 mensole laccate P 31 L 45** 08902394
3 lacquered shelves D 31 W 45
- **2 mensole in alluminio P 31 L 45** 08902374
2 aluminium shelves D 31 W 45

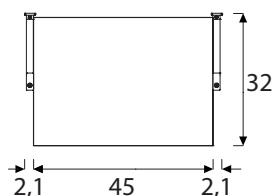

“MULTIPLO” ESEMPI DI COMPONENTABILITÀ

“MULTIPLO” EXAMPLES OF MODULARITY

ESEMPIO “MULTIPLO SOSPESO H 108 L 117,5”

EXAMPLE “MULTIPLO HANGING H 108 W 117,5”

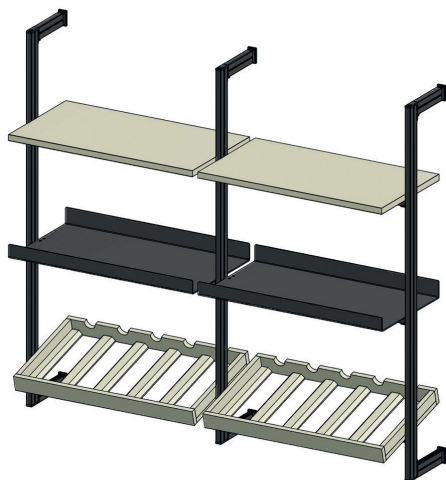

- 1 struttura singola H 108 L 60 08902405
1 single structure H 108 W 60
- 1 struttura centrale H 108 L 57,9 08902405C
1 central structure H 108 W 57,9
- 2 mensole in melaminico P 31 L 55,8 08902385
2 melamine shelves D 31 W 55,8
- 2 mensole in alluminio P 31 L 55,8 08902375
2 aluminium shelves D 31 W 55,8
- 2 portabottiglie in legno P 31 L 55,8 08902295
2 wood bottles rack D 31 W 55,8
- Kit alimentatore 30 Watt (mercato UE) 08902350
Power suppli kit 30 Watt (UE Market)
- **Maggiorazione kit luce led Dual Color** opz.002
Surcharge led light kit Dual Color

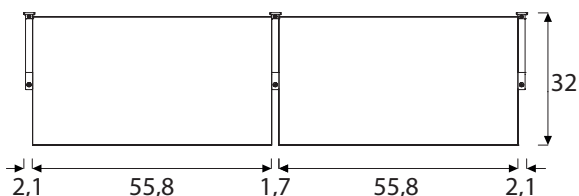

ESEMPIO “MULTIPLO LIBRERIA A PARETE H 217 L 235”

EXAMPLE “MULTIPLO WALL BOOKCASE H 217 W 235”

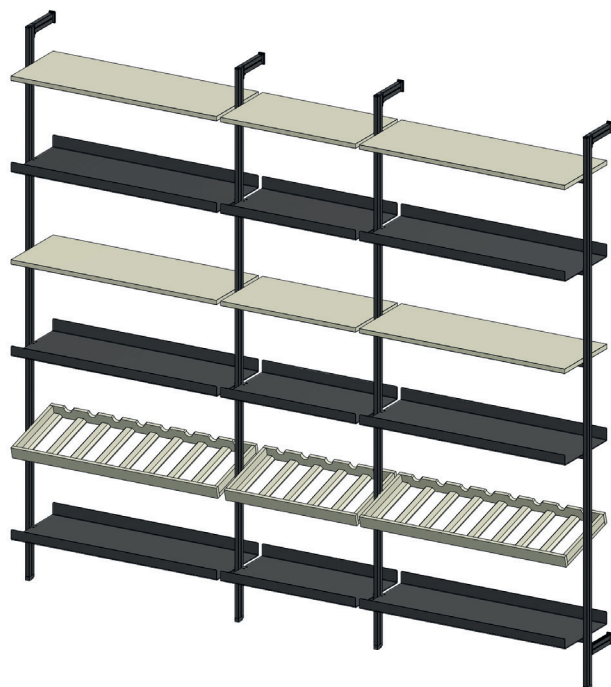

- 1 struttura singola H 217 L 90 08902423
1 single structure H 217 W 90
- 1 struttura centrale H 217 L 57,9 08902421C
1 central structure H 217 W 57,9
- 1 struttura centrale H 217 L 87,9 08902423C
1 central structure H 217 W 87,9
- 4 mensole in melaminico P 31 L 85,8 08902388
4 melamine shelves D 31 W 85,8
- 2 mensole in melaminico P 31 L 55,8 08902385
2 melamine shelves D 31 W 55,8
- 6 mensole in alluminio P 31 L 85,8 08902378
6 aluminium shelves D 31 W 85,8
- 3 mensole in alluminio P 31 L 55,8 08902375
3 aluminium shelves D 31 W 55,8
- 2 portabottiglie in legno P 31 L 85,8 08902298
2 wood bottles rack D 31 W 85,8
- 1 portabottiglie in legno P 31 L 55,8 08902295
1 wood bottles rack D 31 W 55,8
- Kit alimentatore 100 Watt (mercato UE) 08902351
Power suppli kit 100 Watt (UE Market)
- **Maggiorazione kit luce led Dual Color** opz.002
Surcharge led light kit Dual Color

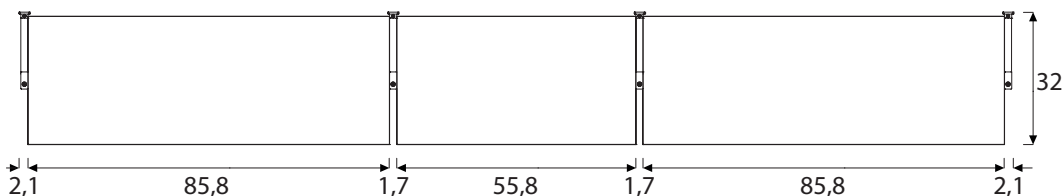

Sign

COLLEZIONE 2021

2021 COLLECTION

LUCE FUNZIONALE
CHE ARREDA

FUNCTIONAL LIGHT
THAT FURNISHES

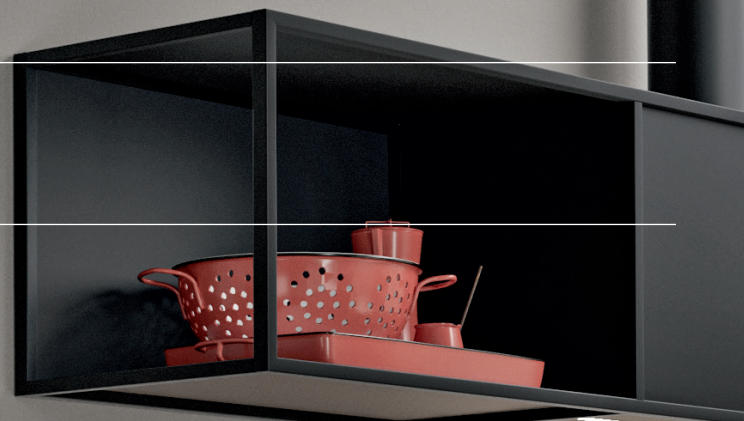

CUCINE
LUBE

GRUPPOLUBE

CREO
KITCHENS

Il profilo a parete può alloggiare cavi di diverse dimensioni, fungendo da canalina passacavo e contribuendo ad organizzare gli elementi in modo ordinato. Gli angoli interni ed esterni a 90° consentono di seguire i volumi architettonici, creando un effetto continuo di luce e arredo nei diversi ambienti domestici. Il grado di protezione IP44 ne consente l'installazione in ambienti soggetti a umidità, schizzi d'acqua e che necessitano di frequenti pulizie come il bagno e la cucina. L'accensione e dimmerazione della luce sono disponibili, su richiesta, con l'integrazione del sensore IR o tramite controlli remoti grazie al nostro sistema di alimentazione Mec Driver.

The wall profile can accommodate cables of various sizes, acting as a cable duct and helping to organise the elements in an orderly manner.

The 90° internal and external angles enable architectural volumes to be followed, creating a continuous effect of light and decoration in the different rooms of the home.

The IP44 degree of protection enables it to be installed in environments subject to humidity, splashing water and frequent cleaning, such as bathrooms and kitchens.

Switching and dimming of the light is available on request with the integration of the IR sensor or via remote controls thanks to our supply system Mec Driver.



Sign integra una coppia di lampade lineari, per un effetto omogeneo a doppia emissione che conferisce un'atmosfera immersiva all'ambiente domestico. Il profilo superiore ha un effetto di luce di cortesia wallwasher mentre il profilo inferiore garantisce una corretta illuminazione con un'emissione funzionale, prevenendo la necessità di installare ulteriori fonti luminose per illuminare il piano di lavoro.

Sign integrates a pair of linear lamps for a homogeneous dual-emission effect that lends an immersive atmosphere to the home environment. The upper profile has a wallwasher courtesy light effect, whilst the lower profile ensures proper lighting with a functional output, preventing the need to install additional light sources to illuminate the worktop.



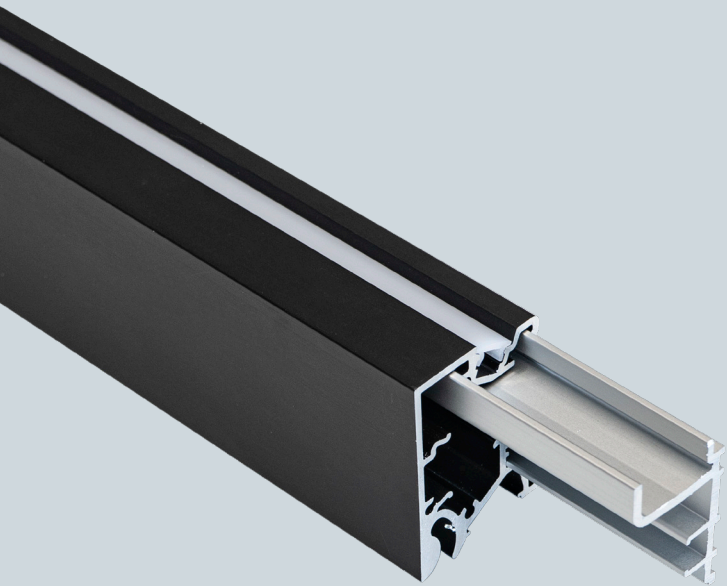

Staffa

La staffa di fissaggio in alluminio viene fissata a parete tramite viti e tasselli.

Bracket

The aluminium fixing bracket is fixed to the wall using screws and dowels.

Cover

Il profilo di copertura, in alluminio anodizzato nero, viene fissato a incastro sulla staffa.

Il vano interno funge da canalina passacavo, contribuendo ad organizzare cavi ed elementi di elettrificazione di Sign e degli altri complementi.

Cover

The cover profile, made of black anodised aluminium, is snapped onto the bracket. The internal compartment acts as a cable duct, helping to organise cables and electrification elements for Sign and other accessories.



Protezione

L'indice di protezione IP44 consente l'applicazione di Sign anche in ambienti soggetti a umidità o che necessitano di pulizie frequenti.

Protection

The IP44 protection rating means that Sign can also be used in environments that are subject to moisture or require frequent cleaning.

IP44

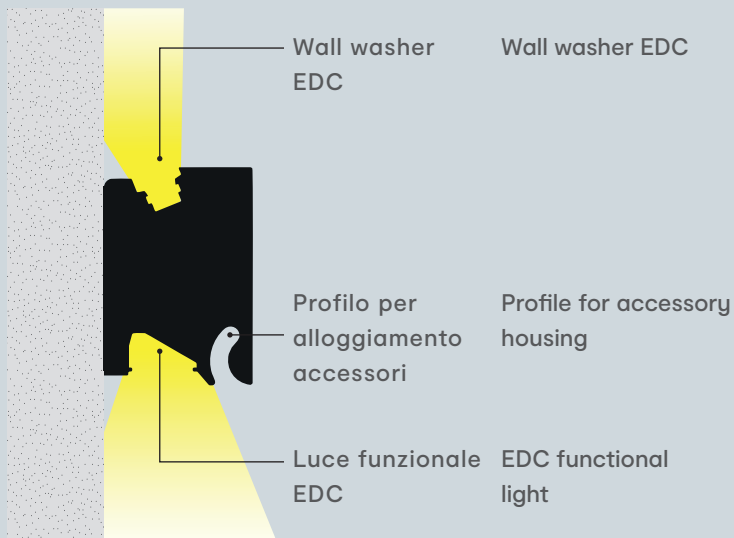

**SIMULAZIONE VISTA
LATERALE SENZA TESTATE
SIMULATION OF SIDE VIEW WITHOUT
HEADERS**

Ottiche dedicate

Le sorgenti luminose sono dotate di ottiche studiate appositamente per creare un effetto wall washer verso l'alto e per illuminare in modo omogeneo e confortevole il piano di lavoro.

Dedicated optics

The light sources are equipped with specially designed optics to create an upward wall washer effect and to illuminate the work surface evenly and comfortably.



Su misura: 200 mm ~ 3000 mm Tailor-made: 200 mm ~ 3000 mm

Sign

Elementi componibili

Modular elements

L'ampia serie di accessori proposti, i moduli a giorno componibili, le mensole e i porta oggetti, rendono Sign adatto ad ogni ambiente domestico, dalla cucina al bagno, dalla zona living all'home office e alla zona notte.

The wide range of accessories offered, the modular open modules, the shelves and the storage units, make Sign suitable for any domestic environment, from the kitchen to the bathroom, from the living area to the home office and the sleeping area.

N.B.: Per dettagli montaggio vedi note specifiche a pag.16

Note: For assembly details see specific notes on page 16



Disegnato da:
Designed by:
Michele Marcon Designer

Sign

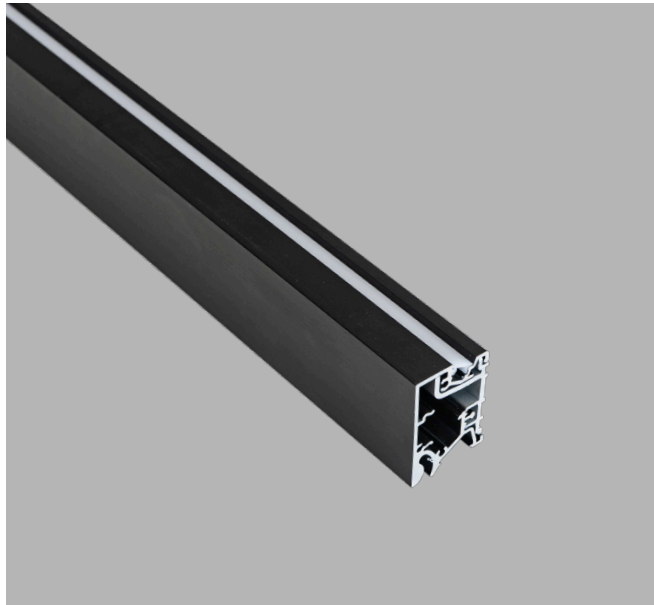

Su richiesta, il profilo è disponibile tagliato a misura. Per un utilizzo come luce decorativa e di cortesia si consiglia di scegliere la combinazione di sorgente superiore e inferiore 120 + 120 LEDs/m, per un utilizzo funzionale, ad esempio in cucina, ufficio o in presenza di piani di lavoro, si consiglia la composizione sorgente superiore 120 + 120 LEDs/m e inferiore 240 + 240 LEDs/m.

On request, the profile is available cut to size and with corner joints.

For use as a decorative and courtesy light we recommend the top and bottom combination 120 + 120 LEDs/m, for functional use, e.g., in kitchens, offices or on worktops, we recommend the top combination 120 + 120 LEDs/m and the bottom combination 240 + 240 LEDs/m.

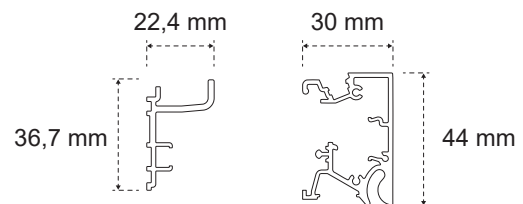

SIGN EDC 24 V DC

120+240 LEDs/m

 086SI120	36,7 W	1200 mm	3000-4000K
 086SI150	46,2 W	1500 mm	3000-4000K
 086SI180	55,6 W	1800 mm	3000-4000K
 086SI240	74,5 W	2400 mm	3000-4000K
 086SI300	93,6 W	3000 mm	3000-4000K
 086SI370	121,7 W	3700 mm	3000-4000K

SIGN AL ML (DA UTILIZZARE PER MISURE NON STANDARD) (TO BE USED FOR NON-STANDARD MEASUREMENTS)

 086SI000	32 W-ml	min.20cm max.370cm	3000-4000K
---	---------	-----------------------	------------

maggiorazione fissa per taglio fuori misura
fixed surcharge for oversize cut

N.B.: Per dettagli montaggio vedi note specifiche a pag.16

Note: For assembly details see specific notes on page 16

ACCESSORI E CONTROLLO ACCESSORIES AND CONTROL



EMOTION JUMPER

Il cavo incluso permette la variazione della temperatura colore da bianco 'caldo' a 'naturale' (3000-4000K).

EMOTION JUMPER

The included cable allows for colour temperature variation from 'warm' to 'natural' white (3000-4000K).



SMART 1 CONTROLLER

Per la scelta del sistema di controllo andare a pagina 18

SMART 1 CONTROLLER

For the choice of control system go to page 18



MEC DRIVER

Per la scelta del sistema di alimentazione andare a pagina 18

MEC DRIVER

For the selection of the power supply system go to page 18

Moduli orizzontali

Horizontal modules



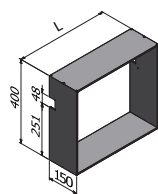

Moduli a giorno in alluminio spazzolato antigraffio di colore nero, installabili ad incastro sul profilo Sign.

Open modules made of black scratch-resistant brushed aluminium, which can be clicked onto the Sign profile.



MODULI ORIZZONTALI 1 VANO

 086SI401	300 x 400 x 150 mm
 086SI402	450 x 400 x 150 mm
 086SI403	600 x 400 x 150 mm

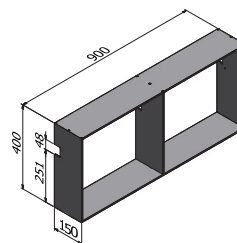

MODULI ORIZZONTALI 2 VANI

 086SI404	900 x 400 x 150 mm
--	--------------------

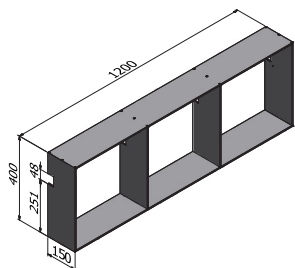

MODULI ORIZZONTALI 3 VANI

 086SI405	1200 x 400 x 150 mm
--	---------------------

Moduli verticali

Vertical modules





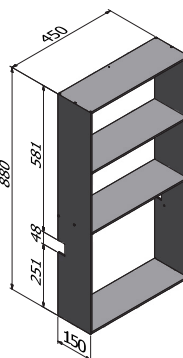
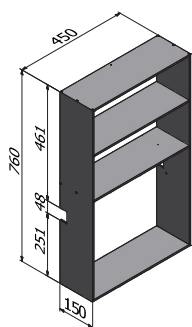

Moduli a giorno in alluminio spazzolato antigraffio di colore nero, installabili ad incastro sul profilo Sign.





Open modules made of black scratch-resistant brushed aluminium, which can be clicked onto the Sign profile.



MODULI VERTICALI SUPERIORI 3 VANI



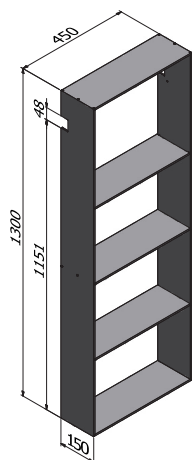

 086SI411	300 x 760 x 150 mm
 086SI412	450 x 760 x 150 mm
 086SI413	600 x 760 x 150 mm
 086SI414	900 x 760 x 150 mm

MODULI VERTICALI SUPERIORI 3 VANI

 086SI421	300 x 880 x 150 mm
 086SI422	450 x 880 x 150 mm
 086SI423	600 x 880 x 150 mm
 086SI424	900 x 880 x 150 mm



MODULI VERTICALI INFERIORI 4 VANI

 086SI431	300 x 1300 x 150 mm
 086SI432	450 x 1300 x 150 mm
 086SI433	600 x 1300 x 150 mm
 086SI434	900 x 1300 x 150 mm

Accessori

Accessories



SET 4 GANCI

 086SI460

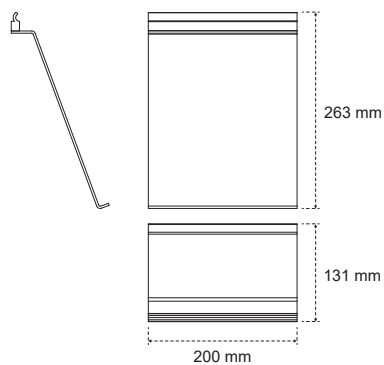

PORTA TABLET

 086SI461

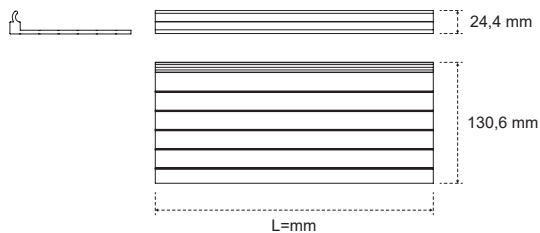

MENSOLE SIGN

 086SI450 286 mm

 086SI451 390 mm

 086SI452 436 mm

 086SI453 586 mm

 086SI454 886 mm

Le mensole sono integrabili all'interno dei moduli a giorno.
The shelves can be integrated into the open modules.

Accessori cucina Kitchen accessories

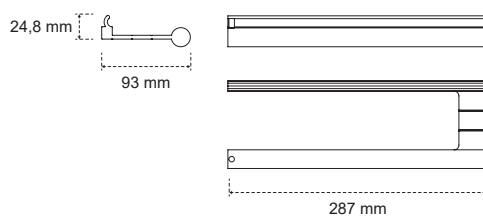

PORTA ROTOLO CARTA CUCINA

⁰³ 086SI462

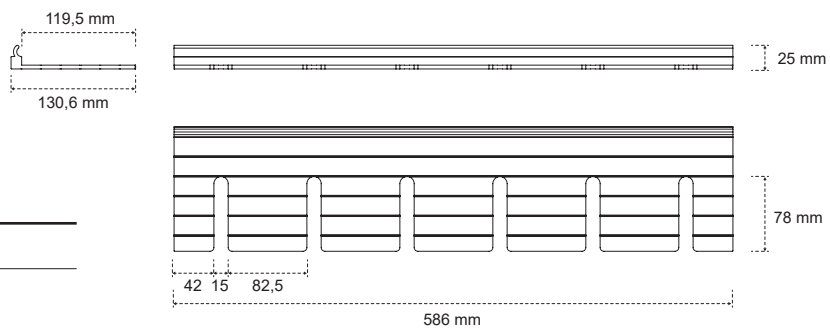
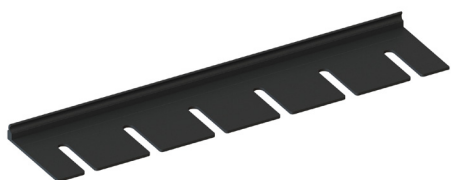

PORTA CALICI

⁰³ 086SI463



MEC DRIVER

**4 ALIMENTATORI IN 1,
CON SISTEMI DI COMANDO INTEGRATI**

Più flessibilità per connettere il futuro

**4 POWER SOURCES IN 1,
WITH INTEGRATED CONTROL SYSTEMS**

Increased flexibility to connect the future

UN DRIVER, INFINITE SOLUZIONI SIA A 12 CHE 24 VDC

ONE DRIVER, ENDLESS OPTIONS BOTH 12 AND 24 VDC



**FUNZIONA SIA A 12VDC CHE 24VDC
IT WORKS BOTH 12VDC AND 24VDC**



**MULTITENSIONE
MULTI-VOLTAGE**
Input: 100\240V AC Output: 12\24V DC



**CERTIFICAZIONI INTERNAZIONALI
ALL LEADING INTERNATIONAL ACCREDITATIONS**



CONTROLLO REMOTO
Via Wi-fi, Radio Frequenza (R.F.), Bluetooth,
controlli vocali
REMOTE CONTROL
Connection via Wi-fi, Radio Frequency (R.F.),
Bluetooth, Zigbee, voice control



**Emotion Dual Color
(3000K ÷ 4000K)**



**Compatibile con i controlli
remoti Smart
Compatible with Smart
remote controller**



**ON - OFF e dimmer
ON - OFF and dimming**



**Gestione del colore
Colour management**



**Connessione Bluetooth da
smartphone
Bluetooth connection
via smartphone**

Mec Driver → Sign

Mec Driver → Sign		Out	N.out	Sorgente luminosa	Features
Alimentazione	Power Supply				
Alimentatore	Power Supply	18 W	24 V		 Input 100-240 V AC
· Sia 12 che 24 vdc	· Both 12-24vdc	36 W	24 V		
· Multi certificato	· Multi certified	48 W	24 V		
· Spessore 16mm	· 16mm thickness	72 W	24 V		
· Differenti cavi di alimentazione	· Different input plugs	90 W	24 V		
		120 W	24 V		
Distribuzione	Distribution				
Distributore	Distributor				
· Connessione luci con o senza controller a bordo	· Lights connection with or without controller onboard	Y Cable	24 V	2	EDC
		Module	24 V	8	EDC
Controllo	Control				
Smart 1	Smart 1				
· Connessione luci	· Lights connection	EDC	24 V	8	EDC
· Controllo remoto	· Remote controller				
· Radiofrequenza	· Radiofrequency				
Bluesmart	Bluesmart				
· Connessione luci	· Lights connection	EDC	24 V	4 ind.	EDC
· Controllo remoto	· Remote controller				
· Bluetooth	· Bluetooth				
· Radiofrequenza	· Radiofrequency				

MEC DRIVER

Modulo alimentatore Power supply module

Il modulo di alimentazione è il cuore pulsante del sistema Mec Driver. Disponibile in sei tagli di potenza, può essere combinato con i moduli di distribuzione e controllo sia a 12 che a 24 V: questi, inseribili ad incastro, permettono di gestire al meglio il proprio sistema luci.

The power supply module is the heart of the Mec Driver system. Available in six power sizes, it can be combined with both 12 and 24 V distribution and control modules: these, which can be docked to the power supply module, allow you to better manage your lighting system.

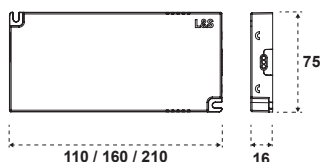

ALIMENTATORE	POWER	OUTPUT	DIMENSIONI	codice code
12591340100	18 W	24 V DC	110 x 75 x 16 mm	08618000
12591350100	36 W	24 V DC	160 x 75 x 16 mm	08618001
12591360100	48 W	24 V DC	160 x 75 x 16 mm	08618002
12591370100	72 W	24 V DC	210 x 75 x 16 mm	08618003
12591380100	90 W	24 V DC	210 x 75 x 16 mm	08618004
12591390100	120 W	24 V DC	210 x 75 x 16 mm	08618005

Cavo di alimentazione Power cable

Il modulo alimentatore supporta una tensione in ingresso di 100-240 V AC, per un utilizzo su scala globale; i cavi di alimentazione, venduti separatamente, consentono di scegliere la tipologia di spina adatta al proprio mercato di riferimento.

The power supply module supports an input voltage of 100-240 V AC, for use on a global scale; the power cables, sold separately, allow you to choose the type of plug suitable for your market.

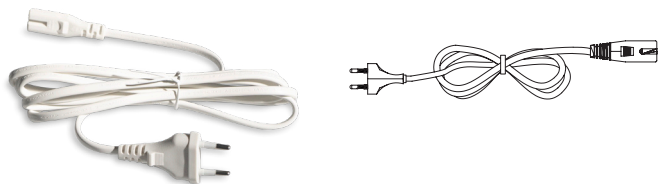

CAVO ALIMENTAZIONE	PLUG	TIPO	DIMENSIONI	codice code
12606690100		USA/CANADA	2 m	08618021
12606710100		EU	2 m	08618020

DISTRIBUTOR

Cavo a Y Y cable

Il cavo a Y, permette di collegare due lampade direttamente al modulo di alimentazione.

The Y cables, allows two lamps to be connected directly to the power supply module.



DISTRIBUTOR	WAYS	OUTPUT	codice code
126606840000	2	Max 48 W-2 A Total output	08618027

Modulo Module

Il modulo distributore, consente di collegare fino a 8 lampade al modulo alimentatore. I moduli possono essere integrati con altri moduli di distribuzione o controllo purché si mantenga la stessa tensione in uscita.

The distributor module, allows up to 8 lamps to be connected to the power supply module. The modules can be integrated with other distribution or control modules as long as the same output voltage is maintained.

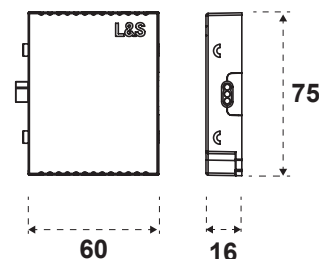
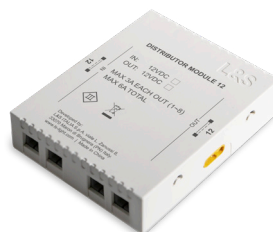

DISTRIBUTOR	WAYS	OUTPUT	codice code
24600140100	8	Max 5 A total, max 3 A/output	08618025

SMART 1



Controller Controller

Controller wireless touch. Controlla le luci sia per funzioni di dimmerazione dell'intensità luminosa, che di cambio della temperatura colore.

Wireless touch controller. It controls the lights both for dimming the light intensity and for changing the colour temperature.



- On/Off - Dimmerazione - Gestione del colore
- 20 m portata all'interno di edifici
- Batteria CR2450 (3 anni di durata)

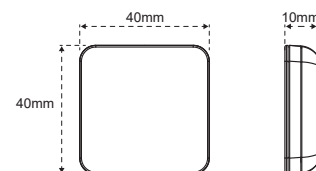

SMART 1 CONTROLLER	TIPO	codice code
24201640300	EDC	08618034

SMART 1



Modulo Module

Il modulo Smart 1 consente di controllare simultaneamente fino a 8 lampade in uscita con i telecomandi della linea Smart 1 Controller.

The Smart 1 module allows you to simultaneously control up to 8 output lamps with the Smart 1 Controller.

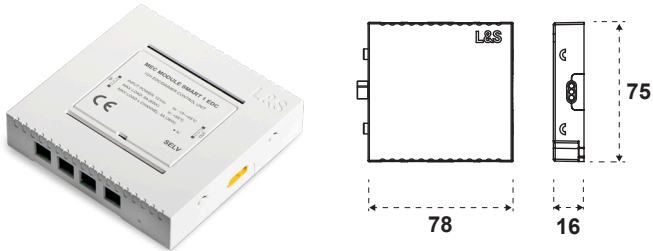

SMART 1	TIPO	INPUT	WAYS	codice code
24201880100	EDC	24 V DC	8	08618031



SMART 1
Controller

BLUESMART



Modulo Module

Il modulo Bluesmart consente di controllare individualmente fino a 4 lampade in uscita tramite l'apposita app, scaricabile gratuitamente da App Store e Google Play.

The Bluesmart module allows you to individually control up to 4 output lamps using the Bluesmart app, which can be downloaded for free from the App Store and Google Play.

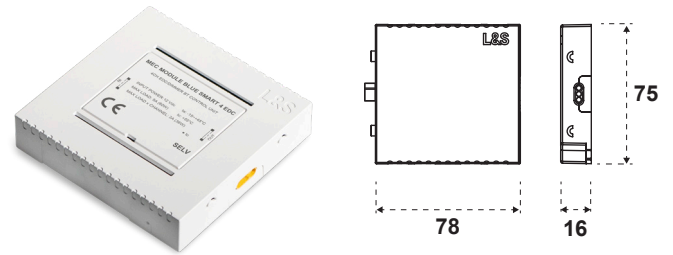

BLUESMART	TIPO	INPUT	WAYS	codice code
24201770100	EDC	24 V DC	4	08618030

Mobile App

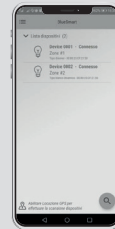

DEVICE SETTING

Consente di visualizzare i dispositivi connessi suddivisi in zone.

Displays the connected devices divided into zones.



SWITCH MODE

Consente di selezionare, accendere o spegnere le singole zone.

Allows you to select, switch on or off individual zones.

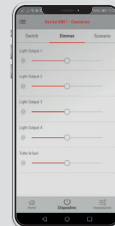

DIMMER MODE

Consente di regolare l'intensità luminosa di ogni singola lampada.

Allows you to adjust the light intensity of each individual lamp.



SCENARIO MODE

Consente di gestire fino a 4 diversi scenari da configurare con le impostazioni preferite.

It allows you to manage up to 4 different scenarios to configure with your preferred settings.

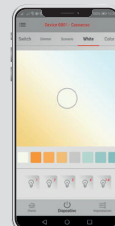

WHITE MODE

Nelle versioni EDC, consente di selezionare la temperatura di colore di ogni singola lampada.

In the EDC versions, it allows you to select the color temperature of each individual lamp.

Ogni controller e sensore della linea Smart può controllare fino a 6 moduli.
Each controller and sensors in the Smart line can control up to 6 modules.

Schemi Montaggio

Assembly diagrams

In fase di montaggio si può scegliere il lato di fuoriuscita dei connettori led.
 Per evitare che gli stessi rimangano a vista consigliamo l'utilizzo di uno schienale o di veicolarene l'uscita in prossimità di un fianco a battuta. (Vedi schemi riportati a seguire)

During the assembly phase, you can choose the side of the LED connectors.
 To prevent them from remaining visible, we recommend the use of a backrest or to convey the exit in the vicinity of a stop flank. (See diagrams below)

ESEMPI DI APPLICAZIONE LATO FIANCO A BATTUTA EXAMPLES OF APPLICATION ON THE SIDE-TO-STOP SIDE

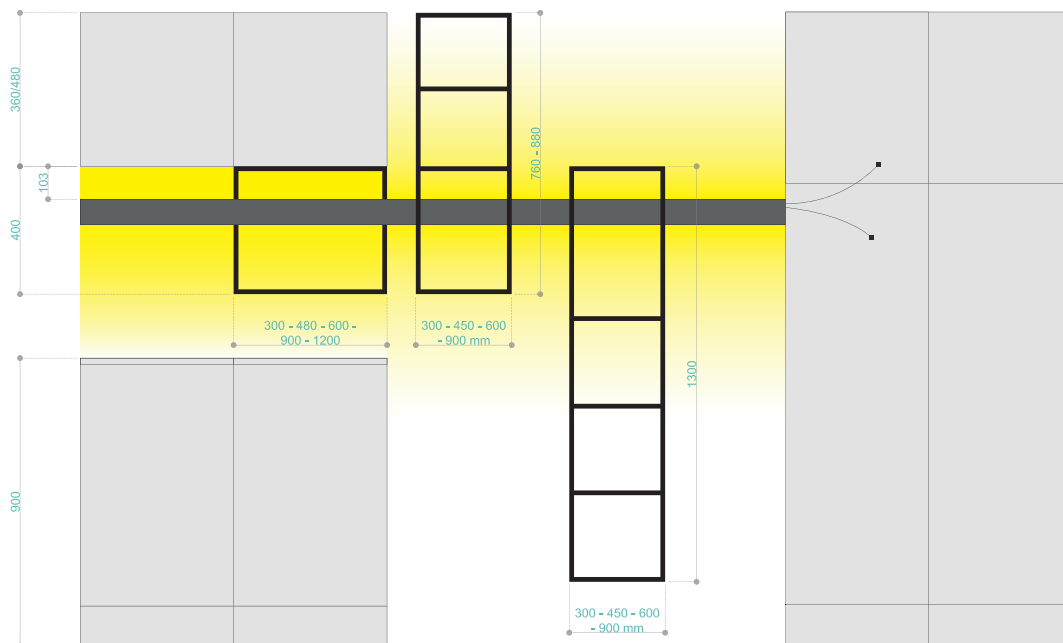

Esempio di applicazione in cucina
 Example of application in the kitchen

ESEMPI DI APPLICAZIONE LATO FIANCO CON SCHIENALE APPLICATION EXAMPLES SIDE SIDE WITH BACK PANEL

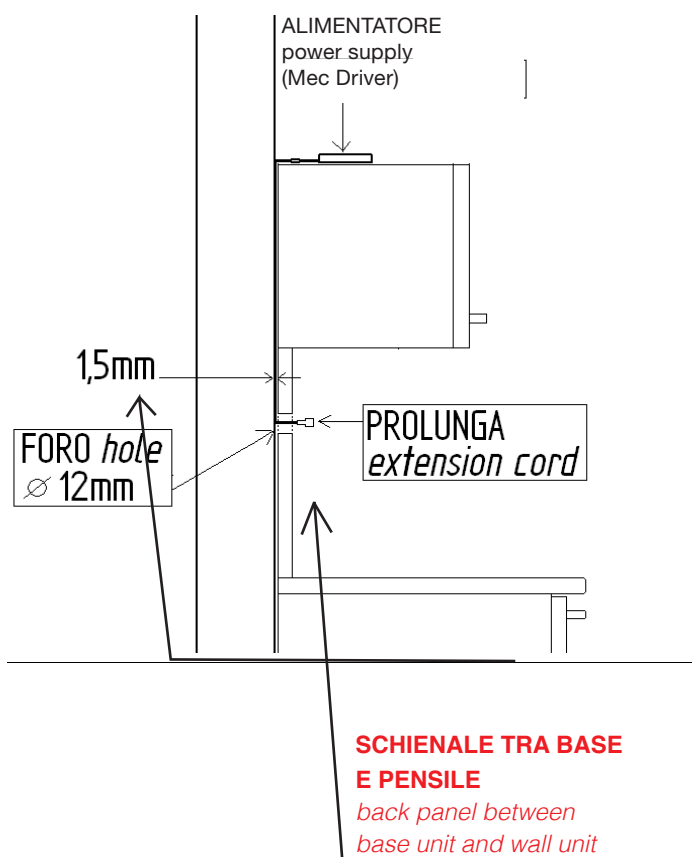



GRUPPO LUBE



Modular



MODULAR SENZA SCHIENA

MODULAR WITHOUT BACK PANEL

Modulo cm 60-90-120 P 13
tra base e pensile con ripiano.
3 ganci predisposto per
accessori

Rack element
 cm 60-90-120 D 13
 between base unit and wall
 unit with shelf.
 3 hooks, suitable for
 accessories

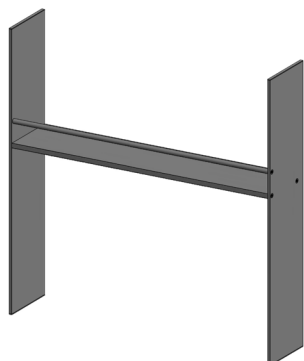

TIPO A1

L 60

H 53 top sp.4
 H 54 top sp.3
 H 54,6 top sp.2,4
 H 55 top sp.2
 H 55,8 top sp.1,2

L 65

H 53 top sp.4
 H 54 top sp.3
 H 54,6 top sp.2,4
 H 55 top sp.2
 H 55,8 top sp.1,2

L 90

H 53 top sp.4
 H 54 top sp.3
 H 54,6 top sp.2,4
 H 55 top sp.2
 H 55,8 top sp.1,2

L 120

H 53 top sp.4
 H 54 top sp.3
 H 54,6 top sp.2,4
 H 55 top sp.2
 H 55,8 top sp.1,2

TIPO A2

L 60

H 56 top sp.4
 H 57 top sp.3
 H 57,6 top sp.2,4
 H 58 top sp.2
 H 58,8 top sp.1,2

L 65

H 56 top sp.4
 H 57 top sp.3
 H 57,6 top sp.2,4
 H 58 top sp.2
 H 58,8 top sp.1,2

L 90

H 56 top sp.4
 H 57 top sp.3
 H 57,6 top sp.2,4
 H 58 top sp.2
 H 58,8 top sp.1,2

L 120

H 56 top sp.4
 H 57 top sp.3
 H 57,6 top sp.2,4
 H 58 top sp.2
 H 58,8 top sp.1,2

TYPE A1

L 60

H 53 worktop th.4
 H 54 worktop th.3
 H 54,6 worktop th.2,4
 H 55 worktop th.2
 H 55,8 worktop th.1,2

L 65

H 53 worktop th.4
 H 54 worktop th.3
 H 54,6 worktop th.2,4
 H 55 worktop th.2
 H 55,8 worktop th.1,2

L 90

H 53 worktop th.4
 H 54 worktop th.3
 H 54,6 worktop th.2,4
 H 55 worktop th.2
 H 55,8 worktop th.1,2

L 120

H 53 worktop th.4
 H 54 worktop th.3
 H 54,6 worktop th.2,4
 H 55 worktop th.2
 H 55,8 worktop th.1,2

TYPE A2

L 60

H 56 worktop th.4
 H 57 worktop th.3
 H 57,6 worktop th.2,4
 H 58 worktop th.2
 H 58,8 worktop th.1,2

L 65

H 56 worktop th.4
 H 57 worktop th.3
 H 57,6 worktop th.2,4
 H 58 worktop th.2
 H 58,8 worktop th.1,2

L 90

H 56 worktop th.4
 H 57 worktop th.3
 H 57,6 worktop th.2,4
 H 58 worktop th.2
 H 58,8 worktop th.1,2

L 120

H 56 worktop th.4
 H 57 worktop th.3
 H 57,6 worktop th.2,4
 H 58 worktop th.2
 H 58,8 worktop th.1,2

CODICE
CODE No.

ACCIAIO
 STEEL

TITANIO
 TITANIUM

BRUNITO
 BURNISHED

086MA1160
086MA1360
086MA1560
086MA1760
086MA1960

086MA1165
086MA1365
086MA1565
086MA1765
086MA1965

086MA1190
086MA1390
086MA1590
086MA1790
086MA1990

086MA1195
086MA1395
086MA1595
086MA1795
086MA1995

086MA2160
086MA2360
086MA2560
086MA2760
086MA2960

086MA2165
086MA2365
086MA2565
086MA2765
086MA2965

086MA2190
086MA2390
086MA2590
086MA2790
086MA2990

086MA2195
086MA2395
086MA2595
086MA2795
086MA2995

Finiture "MODULAR"

"MODULAR" finishes



Acciaio (opz.A)
 Stainless Steel



Titanio (opz.T)
 Titanium



Brunito (opz.B)
 Burnished

MODULAR SENZA SCHIENA

MODULAR WITHOUT BACK PANEL

Modulo cm 60-90-120 P 13
in appoggio con cielo e ripiano.

Lean on rack element
cm 60-90-120 D 13
with top panel and shelf.

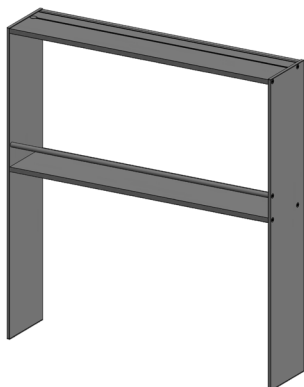

TIPO B1
L 60

H 65 top sp.4
H 66 top sp.3
H 66,6 top sp.2,4
H 67 top sp.2
H 67,8 top sp.1,2

L 65

H 65 top sp.4
H 66 top sp.3
H 66,6 top sp.2,4
H 67 top sp.2
H 67,8 top sp.1,2

L 90

H 65 top sp.4
H 66 top sp.3
H 66,6 top sp.2,4
H 67 top sp.2
H 67,8 top sp.1,2

L 120

H 65 top sp.4
H 66 top sp.3
H 66,6 top sp.2,4
H 67 top sp.2
H 67,8 top sp.1,2

TIPO B2
L 60

H 68 top sp.4
H 69 top sp.3
H 69,6 top sp.2,4
H 70 top sp.2
H 70,8 top sp.1,2

L 65

H 68 top sp.4
H 69 top sp.3
H 69,6 top sp.2,4
H 70 top sp.2
H 70,8 top sp.1,2

L 90

H 68 top sp.4
H 69 top sp.3
H 69,6 top sp.2,4
H 70 top sp.2
H 70,8 top sp.1,2

L 120

H 68 top sp.4
H 69 top sp.3
H 69,6 top sp.2,4
H 70 top sp.2
H 70,8 top sp.1,2

TYPE B1
L 60

H 65 worktop th.4
H 66 worktop th.3
H 66,6 worktop th.2,4
H 67 worktop th.2
H 67,8 worktop th.1,2

L 65

H 65 worktop th.4
H 66 worktop th.3
H 66,6 worktop th.2,4
H 67 worktop th.2
H 67,8 worktop th.1,2

L 90

H 65 worktop th.4
H 66 worktop th.3
H 66,6 worktop th.2,4
H 67 worktop th.2
H 67,8 worktop th.1,2

L 120

H 65 worktop th.4
H 66 worktop th.3
H 66,6 worktop th.2,4
H 67 worktop th.2
H 67,8 worktop th.1,2

TYPE B2
L 60

H 68 worktop th.4
H 69 worktop th.3
H 69,6 worktop th.2,4
H 70 worktop th.2
H 70,8 worktop th.1,2

L 65

H 68 worktop th.4
H 69 worktop th.3
H 69,6 worktop th.2,4
H 70 worktop th.2
H 70,8 worktop th.1,2

L 90

H 68 worktop th.4
H 69 worktop th.3
H 69,6 worktop th.2,4
H 70 worktop th.2
H 70,8 worktop th.1,2

L 120

H 68 worktop th.4
H 69 worktop th.3
H 69,6 worktop th.2,4
H 70 worktop th.2
H 70,8 worktop th.1,2

CODICE
CODE No.

ACCIAIO
STEEL

TITANIO
TITANIUM

BRUNITO
BURNISHED

086MA3160
086MA3360
086MA3560
086MA3760
086MA3960

086MA3165
086MA3365
086MA3565
086MA3765
086MA3965

086MA3190
086MA3390
086MA3590
086MA3790
086MA3990

086MA3195
086MA3395
086MA3595
086MA3795
086MA3995

086MA4160
086MA4360
086MA4560
086MA4760
086MA4960

086MA4165
086MA4365
086MA4565
086MA4765
086MA4965

086MA4190
086MA4390
086MA4590
086MA4790
086MA4990

086MA4195
086MA4395
086MA4595
086MA4795
086MA4995



MODULAR SENZA SCHIENA

MODULAR WITHOUT BACK PANEL

Modulo cm 60-90-120 P 13
in appoggio con cielo e 2 ripiani.

Lean on rack element
cm 60-90-120 D 13
with top panel and 2 shelves.

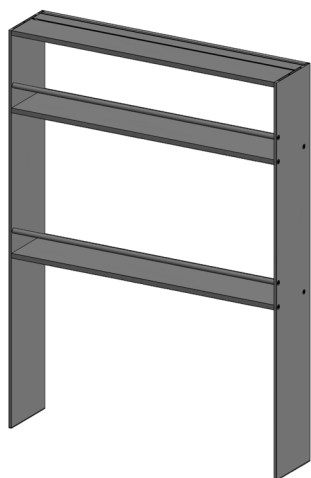

TIPO C1

L 60
H 77 top sp.4
H 78 top sp.3
H 78,6 top sp.2,4
H 79 top sp.2
H 79,8 top sp.1,2

L 65
H 77 top sp.4
H 78 top sp.3
H 78,6 top sp.2,4
H 79 top sp.2
H 79,8 top sp.1,2

L 90
H 77 top sp.4
H 78 top sp.3
H 78,6 top sp.2,4
H 79 top sp.2
H 79,8 top sp.1,2

L 120
H 77 top sp.4
H 78 top sp.3
H 78,6 top sp.2,4
H 79 top sp.2
H 79,8 top sp.1,2

TIPO C2

L 60
H 80 top sp.4
H 81 top sp.3
H 81,6 top sp.2,4
H 82 top sp.2
H 82,8 top sp.1,2

L 65
H 80 top sp.4
H 81 top sp.3
H 81,6 top sp.2,4
H 82 top sp.2
H 82,8 top sp.1,2

L 90
H 80 top sp.4
H 81 top sp.3
H 81,6 top sp.2,4
H 82 top sp.2
H 82,8 top sp.1,2

L 120
H 80 top sp.4
H 81 top sp.3
H 81,6 top sp.2,4
H 82 top sp.2
H 82,8 top sp.1,2

TYPE C1

L 60
H 77 worktop th.4
H 78 worktop th.3
H 78,6 worktop th.2,4
H 79 worktop th.2
H 79,8 worktop th.1,2

L 65
H 77 worktop th.4
H 78 worktop th.3
H 78,6 worktop th.2,4
H 79 worktop th.2
H 79,8 worktop th.1,2

L 90
H 77 worktop th.4
H 78 worktop th.3
H 78,6 worktop th.2,4
H 79 worktop th.2
H 79,8 worktop th.1,2

L 120
H 77 worktop th.4
H 78 worktop th.3
H 78,6 worktop th.2,4
H 79 worktop th.2
H 79,8 worktop th.1,2

TYPE C2

L 60
H 80 worktop th.4
H 81 worktop th.3
H 81,6 worktop th.2,4
H 82 worktop th.2
H 82,8 worktop th.1,2

L 65
H 80 worktop th.4
H 81 worktop th.3
H 81,6 worktop th.2,4
H 82 worktop th.2
H 82,8 worktop th.1,2

L 90
H 80 worktop th.4
H 81 worktop th.3
H 81,6 worktop th.2,4
H 82 worktop th.2
H 82,8 worktop th.1,2

L 120
H 80 worktop th.4
H 81 worktop th.3
H 81,6 worktop th.2,4
H 82 worktop th.2
H 82,8 worktop th.1,2

CODICE
CODE No.

ACCIAIO
STEEL

TITANIO
TITANIUM

BRUNITO
BURNISHED

086MA5160
086MA5360
086MA5560
086MA5760
086MA5960

086MA5165
086MA5365
086MA5565
086MA5765
086MA5965

086MA5190
086MA5390
086MA5590
086MA5790
086MA5990

086MA5195
086MA5395
086MA5595
086MA5795
086MA5995

086MA6160
086MA6360
086MA6560
086MA6760
086MA6960

086MA6165
086MA6365
086MA6565
086MA6765
086MA6965

086MA6190
086MA6390
086MA6590
086MA6790
086MA6990

086MA6195
086MA6395
086MA6595
086MA6795
086MA6995

Finiture "MODULAR"

"MODULAR" finishes

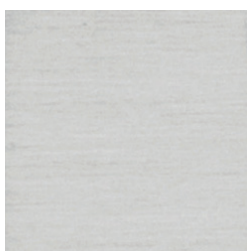

Acciaio (opz.A)
Stainless Steel



Titanio (opz.T)
Titanium



Brunito (opz.B)
Burnished

MODULAR SENZA SCHIENA

MODULAR WITHOUT BACK PANEL

Modulo cm 60-90-120 P 13
in appoggio con cielo e 2 ripiani.

Lean on rack element
cm 60-90-120 D 13
with top panel and 2 shelves.

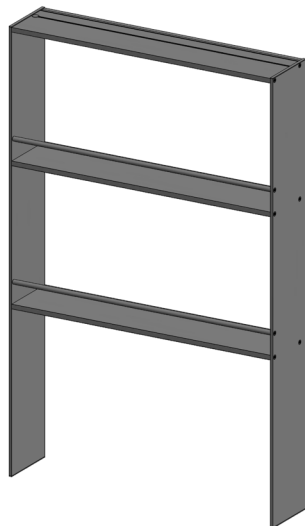

TIPO D1

L 60

H 89 top sp.4
H 90 top sp.3
H 90,6 top sp.2,4
H 91 top sp.2
H 91,8 top sp.1,2

L 65

H 89 top sp.4
H 90 top sp.3
H 90,6 top sp.2,4
H 91 top sp.2
H 91,8 top sp.1,2

L 90

H 89 top sp.4
H 90 top sp.3
H 90,6 top sp.2,4
H 91 top sp.2
H 91,8 top sp.1,2

L 120

H 89 top sp.4
H 90 top sp.3
H 90,6 top sp.2,4
H 91 top sp.2
H 91,8 top sp.1,2

TIPO D2

L 60

H 92 top sp.4
H 93 top sp.3
H 93,6 top sp.2,4
H 94 top sp.2
H 94,8 top sp.1,2

L 65

H 92 top sp.4
H 93 top sp.3
H 93,6 top sp.2,4
H 94 top sp.2
H 94,8 top sp.1,2

L 90

H 92 top sp.4
H 93 top sp.3
H 93,6 top sp.2,4
H 94 top sp.2
H 94,8 top sp.1,2

L 120

H 92 top sp.4
H 93 top sp.3
H 93,6 top sp.2,4
H 94 top sp.2
H 94,8 top sp.1,2

TYPE D1

L 60

H 89 worktop th.4
H 90 worktop th.3
H 90,6 worktop th.2,4
H 91 worktop th.2
H 91,8 worktop th.1,2

L 65

H 89 worktop th.4
H 90 worktop th.3
H 90,6 worktop th.2,4
H 91 worktop th.2
H 91,8 worktop th.1,2

L 90

H 89 worktop th.4
H 90 worktop th.3
H 90,6 worktop th.2,4
H 91 worktop th.2
H 91,8 worktop th.1,2

L 120

H 89 worktop th.4
H 90 worktop th.3
H 90,6 worktop th.2,4
H 91 worktop th.2
H 91,8 worktop th.1,2

TYPE D2

L 60

H 92 worktop th.4
H 93 worktop th.3
H 93,6 worktop th.2,4
H 94 worktop th.2
H 94,8 worktop th.1,2

L 65

H 92 worktop th.4
H 93 worktop th.3
H 93,6 worktop th.2,4
H 94 worktop th.2
H 94,8 worktop th.1,2

L 90

H 92 worktop th.4
H 93 worktop th.3
H 93,6 worktop th.2,4
H 94 worktop th.2
H 94,8 worktop th.1,2

L 120

H 92 worktop th.4
H 93 worktop th.3
H 93,6 worktop th.2,4
H 94 worktop th.2
H 94,8 worktop th.1,2

CODICE
CODE No.

ACCIAIO
STEEL

TITANIO
TITANIUM

BRUNITO
BURNISHED

086MB1160
086MB1360
086MB1560
086MB1760
086MB1960

086MB1165
086MB1365
086MB1565
086MB1765
086MB1965

086MB1190
086MB1390
086MB1590
086MB1790
086MB1990

086MB1195
086MB1395
086MB1595
086MB1795
086MB1995

086MB2160
086MB2360
086MB2560
086MB2760
086MB2960

086MB2165
086MB2365
086MB2565
086MB2765
086MB2965

086MB2190
086MB2390
086MB2590
086MB2790
086MB2990

086MB2195
086MB2395
086MB2595
086MB2795
086MB2995

Finiture "MODULAR"

"MODULAR" finishes



Acciaio (opz.A)
Stainless Steel



Titanio (opz.T)
Titanium



Brunito (opz.B)
Burnished

MODULAR SENZA SCHIENA

MODULAR WITHOUT BACK PANEL

Modulo cm 60-90-120 P 13
in appoggio con cielo e 2 ripiani.

Lean on rack element
cm 60-90-120 D 13
with top panel and 2 shelves.

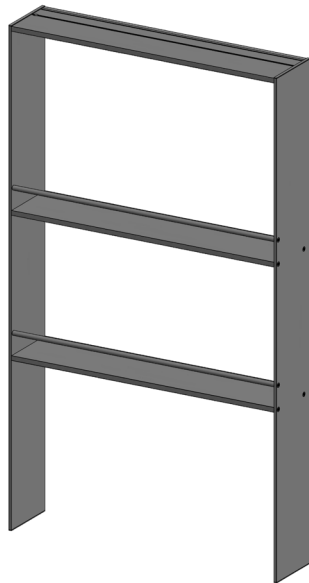

TIPO E1

L 60

H 101 top sp.4
H 102 top sp.3
H 102,6 top sp.2,4
H 103 top sp.2
H 103,8 top sp.1,2

L 65

H 101 top sp.4
H 102 top sp.3
H 102,6 top sp.2,4
H 103 top sp.2
H 103,8 top sp.1,2

L 90

H 101 top sp.4
H 102 top sp.3
H 102,6 top sp.2,4
H 103 top sp.2
H 103,8 top sp.1,2

L 120

H 101 top sp.4
H 102 top sp.3
H 102,6 top sp.2,4
H 103 top sp.2
H 103,8 top sp.1,2

TIPO E2

L 60

H 104 top sp.4
H 105 top sp.3
H 105,6 top sp.2,4
H 106 top sp.2
H 106,8 top sp.1,2

L 65

H 104 top sp.4
H 105 top sp.3
H 105,6 top sp.2,4
H 106 top sp.2
H 106,8 top sp.1,2

L 90

H 104 top sp.4
H 105 top sp.3
H 105,6 top sp.2,4
H 106 top sp.2
H 106,8 top sp.1,2

L 120

H 104 top sp.4
H 105 top sp.3
H 105,6 top sp.2,4
H 106 top sp.2
H 106,8 top sp.1,2

TYPE E1

L 60

H 101 worktop th.4
H 102 worktop th.3
H 102,6 worktop th.2,4
H 103 worktop th.2
H 103,8 worktop th.1,2

L 65

H 101 worktop th.4
H 102 worktop th.3
H 102,6 worktop th.2,4
H 103 worktop th.2
H 103,8 worktop th.1,2

L 90

H 101 worktop th.4
H 102 worktop th.3
H 102,6 worktop th.2,4
H 103 worktop th.2
H 103,8 worktop th.1,2

L 120

H 101 worktop th.4
H 102 worktop th.3
H 102,6 worktop th.2,4
H 103 worktop th.2
H 103,8 worktop th.1,2

TYPE E2

L 60

H 104 worktop th.4
H 105 worktop th.3
H 105,6 worktop th.2,4
H 106 worktop th.2
H 106,8 worktop th.1,2

L 60

H 104 worktop th.4
H 105 worktop th.3
H 105,6 worktop th.2,4
H 106 worktop th.2
H 106,8 worktop th.1,2

L 90

H 104 worktop th.4
H 105 worktop th.3
H 105,6 worktop th.2,4
H 106 worktop th.2
H 106,8 worktop th.1,2

L 120

H 104 worktop th.4
H 105 worktop th.3
H 105,6 worktop th.2,4
H 106 worktop th.2
H 106,8 worktop th.1,2

CODICE
CODE No.

ACCIAIO
STEEL

TITANIO
TITANIUM

BRUNITO
BURNISHED

086MB3160
086MB3360
086MB3560
086MB3760
086MB3960

086MB3165
086MB3365
086MB3565
086MB3765
086MB3965

086MB3190
086MB3390
086MB3590
086MB3790
086MB3990

086MB3195
086MB3395
086MB3595
086MB3795
086MB3995

086MB4160
086MB4360
086MB4560
086MB4760
086MB4960

086MB4165
086MB4365
086MB4565
086MB4765
086MB4965

086MB4190
086MB4390
086MB4590
086MB4790
086MB4990

086MB4195
086MB4395
086MB4595
086MB4795
086MB4995

Finiture "MODULAR"

"MODULAR" finishes

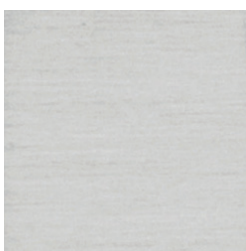

Acciaio (opz.A)
Stainless Steel



Titanio (opz.T)
Titanium



Brunito (opz.B)
Burnished

MODULAR SENZA SCHIENA

MODULAR WITHOUT BACK PANEL

Modulo cm 60-90 P 13
in appoggio con cielo e 3 ripiani.

Lean on rack element
cm 60-90-120 D 13
with top panel and 3 shelves.

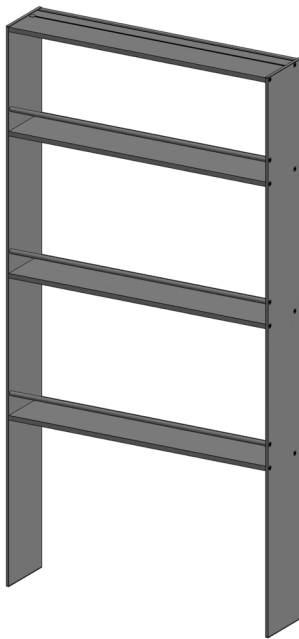

TIPO F1

L 60

H 125 top sp.4
H 126 top sp.3
H 126,6 top sp.2,4
H 127 top sp.2
H 127,8 top sp.1,2

L 65

H 125 top sp.4
H 126 top sp.3
H 126,6 top sp.2,4
H 127 top sp.2
H 127,8 top sp.1,2

L 90

H 125 top sp.4
H 126 top sp.3
H 126,6 top sp.2,4
H 127 top sp.2
H 127,8 top sp.1,2

TIPO F2

L 60

H 128 top sp.4
H 129 top sp.3
H 129,6 top sp.2,4
H 130 top sp.2
H 130,8 top sp.1,2

L 65

H 128 top sp.4
H 129 top sp.3
H 129,6 top sp.2,4
H 130 top sp.2
H 130,8 top sp.1,2

L 90

H 128 top sp.4
H 129 top sp.3
H 129,6 top sp.2,4
H 130 top sp.2
H 130,8 top sp.1,2

TYPE F1

L 60

H 125 worktop th.4
H 126 worktop th.3
H 126,6 worktop th.2,4
H 127 worktop th.2
H 127,8 worktop th.1,2

L 65

H 125 worktop th.4
H 126 worktop th.3
H 126,6 worktop th.2,4
H 127 worktop th.2
H 127,8 worktop th.1,2

L 90

H 125 worktop th.4
H 126 worktop th.3
H 126,6 worktop th.2,4
H 127 worktop th.2
H 127,8 worktop th.1,2

TYPE F2

L 60

H 128 worktop th.4
H 129 worktop th.3
H 129,6 worktop th.2,4
H 130 worktop th.2
H 130,8 worktop th.1,2

L 65

H 128 worktop th.4
H 129 worktop th.3
H 129,6 worktop th.2,4
H 130 worktop th.2
H 130,8 worktop th.1,2

L 90

H 128 worktop th.4
H 129 worktop th.3
H 129,6 worktop th.2,4
H 130 worktop th.2
H 130,8 worktop th.1,2

CODICE
CODE No.

ACCIAIO
STEEL

TITANIO
TITANIUM

BRUNITO
BURNISHED

086MA7160
086MA7360
086MA7560
086MA7760
086MA7960

086MA7165
086MA7365
086MA7565
086MA7765
086MA7965

086MA7190
086MA7390
086MA7590
086MA7790
086MA7990

086MA8160
086MA8360
086MA8560
086MA8760
086MA8960

086MA8165
086MA8365
086MA8565
086MA8765
086MA8965

086MA8190
086MA8390
086MA8590
086MA8790
086MA8990

Finiture "MODULAR"

"MODULAR" finishes



Acciaio (opz.A)
Stainless Steel



Titanio (opz.T)
Titanium



Brunito (opz.B)
Burnished

MODULAR SOSPESO SENZA SCHIENA

MODULAR SUSPENDED WITHOUT BACK PANEL

Modulo H 132 P 13
sospeso con cielo e 4 ripiani.

Hanging rack element
 H 132 D 13
 with top panel and 4 shelves.

CODICE
CODE No.

ACCIAIO
 STEEL

TITANIO
 TITANIUM

BRUNITO
 BURNISHED

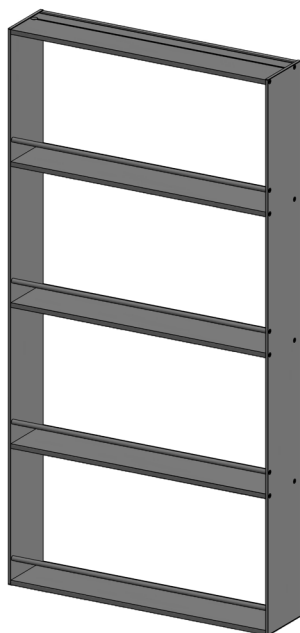

L 60
 L 90

W 60
 W 90

086MB9060
086MB9090



MODULAR CON SCHIENALI

MODULAR WITH BACK PANELS



MODULAR COLORI SCHIENALI

MODULAR COLOURS BACK PANELS

COLORI MELAMICI MODELLO IMMAGINA PLUS

IMMAGINA PLUS MODEL MELAMINE COLOURS

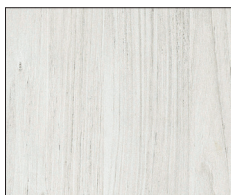

cansiglio bianco
(opz.1561)
white cansiglio

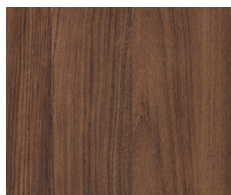

cansiglio terra bruciata
(opz.1562)
scorched earth cansiglio



cansiglio grigio fumo
(opz.1563)
smoke grey cansiglio

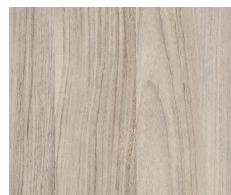

cansiglio sabbia
(opz.1564)
sand cansiglio



cansiglio champagne
(opz.1565)
champagne cansiglio



larice baglia
(opz.1826)
baglia larch

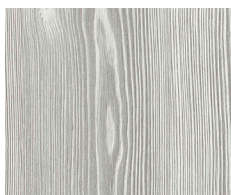

larice laguna
(opz.1827)
lagoon larch



larice vulcano
(opz.1828)
volcano larch

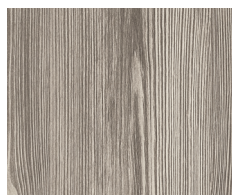

larice terra
(opz.1829)
earth larch

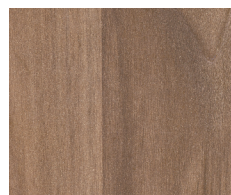

noce
(opz.2363)
walnut



cemento
(opz.9633)
cement



bianco cristallo
(opz.7445)
cristal white

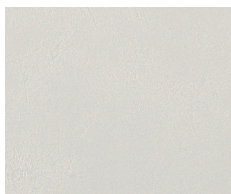

grigio nebbia
(opz.9626)
fog grey



castoro
(opz.8862)
beaver

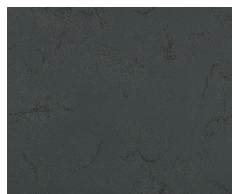

lavagna
(opz.9627)
slate grey



juta
(opz.8863)
jute

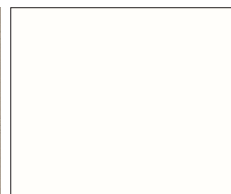

bianco assoluto
(opz.7441)
absolute white

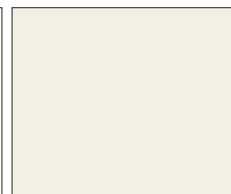

bianco neve
(opz.750)
snow white



grigio sasso
(opz.9650)
pebble grey



verde marino
(opz.8402)
sea green

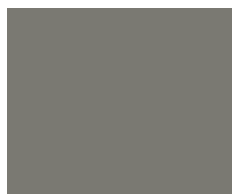

grigio monson
(opz.9651)
monsoon grey



grigio notte
(opz.9652)
midnight grey



grigio velo
(opz.9653)
veil grey

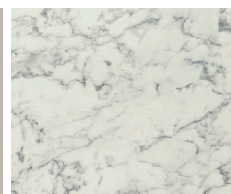

marmo baron
(opz.9632)
baron marble



nicel
(opz.9660)
nickel

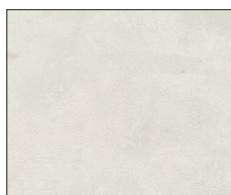

platino
(opz.9661)
platinum



zinco
(opz.9662)
zinc



peltro
(opz.9666)
pewter



titanio
(opz.9665)
titanium



olmo bianco
(opz.5001)
white elm

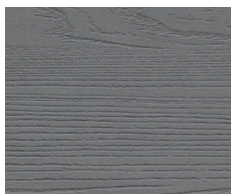

olmo antracite
(opz.5004)
anthracite elm

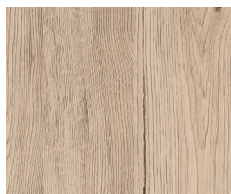

oak miele
(opz.1361)
honey oak



oak neve
(opz.1362)
snow oak



oak cognac
(opz.1363)
cognac oak

MODULAR COLORI SCHIENALI

MODULAR COLOURS BACK PANELS

COLORI MELAMICI MODELLO TABLET - JEY FEEL - SMART

TABLET - JEY FEEL - SMART MODEL MELAMINE COLOURS

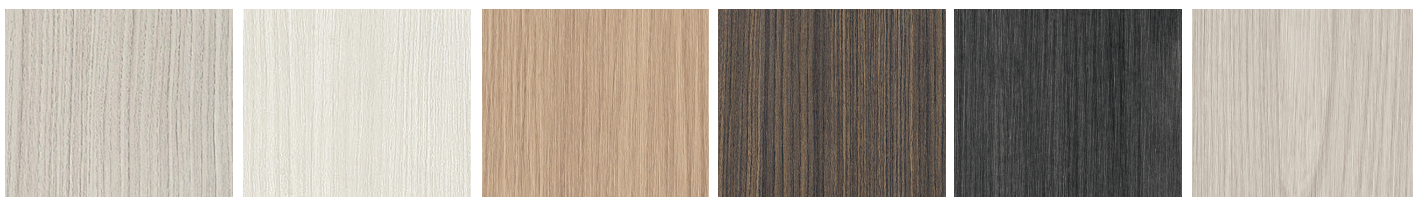

rovere luna
(opz.5316)
moon oak

rovere venere
(opz.5315)
venus oak

rovere arizona
(opz.5317)
arizona oak

rovere dark
(opz.5318)
dark oak

frassino lava
(opz.2408)
lava ash

frassino sabbia
(opz.2406)
sand ash

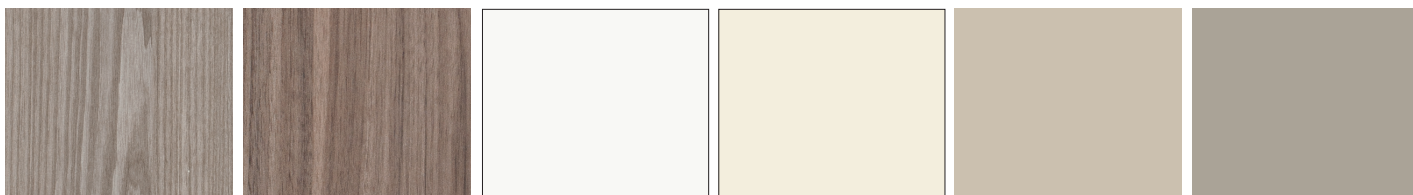

frassino pietra
(opz.2407)
stone ash

noce brown
(opz.2371)
brown walnut

bianco soft matt
(opz.7447N)
soft matt white

porcellana soft matt
(opz.7703N)
soft matt porcelain

desert soft matt
(opz.8914N)
soft matt desert

molaria soft matt
(opz.9636N)
soft matt molaria



arena soft matt (opz.9637N)
soft matt arena

bianco
(opz.9639)
white

bronzo
(opz.8866)
bronze

ardesia
(opz.9638)
slate grey

rovere silver
(opz.5306)
silver oak

rovere diamond
(opz.5307)
diamond oak



rovere tabià
(opz.5309)
tabià oak

rovere ortisei
(opz.5305)
ortisei oak

trani
(opz.7704)
trani

black
(opz.7863)
black

white
(opz.7448)
white

grigio agata
(opz.9623)
agata grey



grigio inox
(opz.9624)
stainless steel grey

rosso cardinale
(opz.8123)
cardinal red

frassino bianco alpino
(opz.2310)
alpine-white ash

rovere greige
(opz.2320)
greige oak

betulla
(opz.2311)
birch

COLORI STRUTTURE

CARCASSES COLOURS



bianco (opz.001)
white

visone (opz.948M)
mink

lavagna (opz.9620)
slate grey

fango (opz.8860)
mud

conchiglia (opz.8910)
shell

argilla (opz.9690)
clay

MODULAR COLORI SCHIENALI

MODULAR COLOURS BACK PANELS

COLORI FENIX

FENIX COLOURS

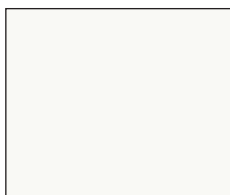

bianco caldo
(opz.0032)
warm white



castoro
(opz.0717)
beaver



fumo
(opz.0718)
smoke



nero
(opz.0720)
black

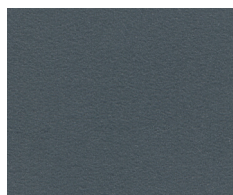

grigio bromo
(opz.0724)
bromine grey

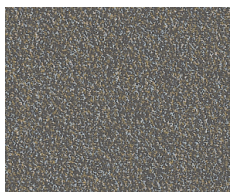

bronzo doha
(opz.2629)
doha bronze



beige arizona
(opz.0748)
arizona beige



cacao orinoco
(opz.0749)
orinoco cocoa

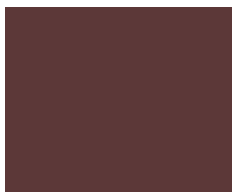

rosso jaipur
(opz.0751)
jaipur red



verde commodoro
(opz.0750)
commodoro green



grigio antrim
(opz.0752)
antrim grey

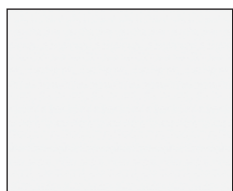

bianco dover
(opz.0757)
dover white



grigio efeso
(opz.0725)
ephesus grey

COLORI EFFETTO MARMO

MARBLE EFFECT COLOURS

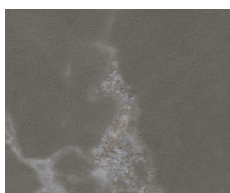

perlato finitura ker
(opz.3443)
pearly with ker finish

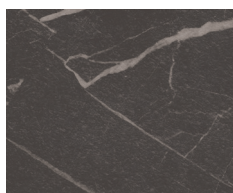

alabastro finitura mn
(opz.6014)
alabaster with mn finish



calacatta finitura mn
(opz.6019)
calacatta with mn finish

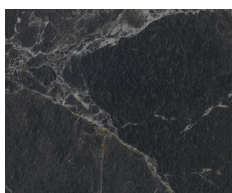

dark finitura mn
(opz.6133)
dark with mn finish

COLORI WOOD IMPIALLACCIATO MODELLO IMMAGINA - TABLET

IMMAGINA - TABLET MODEL VENEERED COLOURS

N.B: non utilizzati per gli elementi da 120

Note: not used for 120 elements

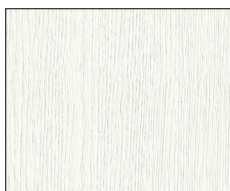

rovere bianco
(opz.5441)
white oak

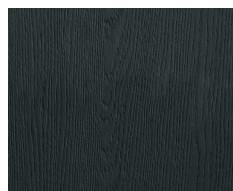

rovere nero
(opz.5446)
black oak



rovere moscato
(opz.5444)
muscat oak

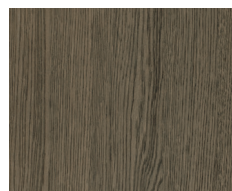

rovere fumè
(opz.5445)
smoked oak

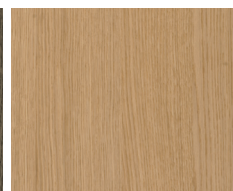

rovere naturale
(opz.5442)
natural oak

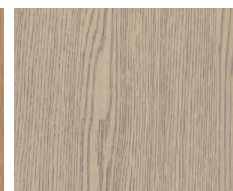

rovere grey
(opz.5443)
grey oak

MODULAR CON SCHIENALE

MODULAR WITH BACK PANEL

Modulo cm 60-90-120 P 15,3
tra base e pensile con ripiano.
3 ganci predisposto per
accessori

Rack element
 cm 60-90-120 D 15,3
 between base unit and wall
 unit with shelf.
 3 hooks suitable for
 accessories.

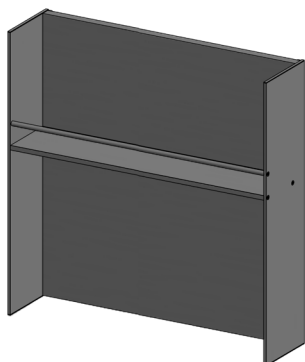

TIPO A1

L 60

H 53 top sp.4
 H 54 top sp.3
 H 54,6 top sp.2,4
 H 55 top sp.2
 H 55,8 top sp.1,2

L 65

H 53 top sp.4
 H 54 top sp.3
 H 54,6 top sp.2,4
 H 55 top sp.2
 H 55,8 top sp.1,2

L 90

H 53 top sp.4
 H 54 top sp.3
 H 54,6 top sp.2,4
 H 55 top sp.2
 H 55,8 top sp.1,2

L 120

H 53 top sp.4
 H 54 top sp.3
 H 54,6 top sp.2,4
 H 55 top sp.2
 H 55,8 top sp.1,2

TIPO A2

L 60

H 56 top sp.4
 H 57 top sp.3
 H 57,6 top sp.2,4
 H 58 top sp.2
 H 58,8 top sp.1,2

L 65

H 56 top sp.4
 H 57 top sp.3
 H 57,6 top sp.2,4
 H 58 top sp.2
 H 58,8 top sp.1,2

L 90

H 56 top sp.4
 H 57 top sp.3
 H 57,6 top sp.2,4
 H 58 top sp.2
 H 58,8 top sp.1,2

L 120

H 56 top sp.4
 H 57 top sp.3
 H 57,6 top sp.2,4
 H 58 top sp.2
 H 58,8 top sp.1,2

TYPE A1

L 60

H 53 worktop th.4
 H 54 worktop th.3
 H 54,6 worktop th.2,4
 H 55 worktop th.2
 H 55,8 worktop th.1,2

L 65

H 53 worktop th.4
 H 54 worktop th.3
 H 54,6 worktop th.2,4
 H 55 worktop th.2
 H 55,8 worktop th.1,2

L 90

H 53 worktop th.4
 H 54 worktop th.3
 H 54,6 worktop th.2,4
 H 55 worktop th.2
 H 55,8 worktop th.1,2

L 120

H 53 worktop th.4
 H 54 worktop th.3
 H 54,6 worktop th.2,4
 H 55 worktop th.2
 H 55,8 worktop th.1,2

TYPE A2

L 60

H 56 worktop th.4
 H 57 worktop th.3
 H 57,6 worktop th.2,4
 H 58 worktop th.2
 H 58,8 worktop th.1,2

L 65

H 56 worktop th.4
 H 57 worktop th.3
 H 57,6 worktop th.2,4
 H 58 worktop th.2
 H 58,8 worktop th.1,2

L 90

H 56 worktop th.4
 H 57 worktop th.3
 H 57,6 worktop th.2,4
 H 58 worktop th.2
 H 58,8 worktop th.1,2

L 120

H 56 worktop th.4
 H 57 worktop th.3
 H 57,6 worktop th.2,4
 H 58 worktop th.2
 H 58,8 worktop th.1,2

CODICE
CODE No.

ACCIAIO
 STEEL

TITANIO
 TITANIUM

BRUNITO
 BURNISHED

086MC1160
086MC1360
086MC1560
086MC1760
086MC1960

086MC1165
086MC1365
086MC1565
086MC1765
086MC1965

086MC1190
086MC1390
086MC1590
086MC1790
086MC1990

086MC1195
086MC1395
086MC1595
086MC1795
086MC1995

086MC2160
086MC2360
086MC2560
086MC2760
086MC2960

086MC2165
086MC2365
086MC2565
086MC2765
086MC2965

086MC2190
086MC2390
086MC2590
086MC2790
086MC2990

086MC2195
086MC2395
086MC2595
086MC2795
086MC2995

SCHIENALI FENIX

FENIX BACK PANELS

SCHIENALI EFFETTO MARMO

EFFECT MARBLE BACK PANELS

SCHIENALI IMPIALLACCIATI WOOD

N.B.: non utilizzati per gli elementi da 120

WOOD VENEERED BACK PANELS

Note: not used for 120 elements



MODULAR CON SCHIENALE

MODULAR WITH BACK PANEL

Modulo cm 60-90-120 P 15,3
in appoggio con cielo e ripiano.

Lean on rack element
cm 60-90-120 D 15,3
with top panel and shelf.

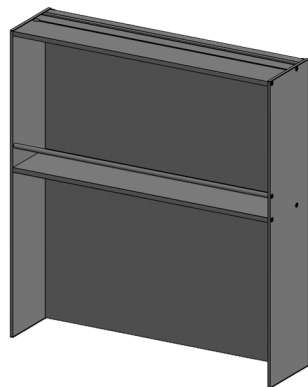

TIPO B1

L 60

H 65 top sp.4
H 66 top sp.3
H 66,6 top sp.2,4
H 67 top sp.2
H 67,8 top sp.1,2

L 65

H 65 top sp.4
H 66 top sp.3
H 66,6 top sp.2,4
H 67 top sp.2
H 67,8 top sp.1,2

L 90

H 65 top sp.4
H 66 top sp.3
H 66,6 top sp.2,4
H 67 top sp.2
H 67,8 top sp.1,2

L 120

H 65 top sp.4
H 66 top sp.3
H 66,6 top sp.2,4
H 67 top sp.2
H 67,8 top sp.1,2

TIPO B2

L 60

H 68 top sp.4
H 69 top sp.3
H 69,6 top sp.2,4
H 70 top sp.2
H 70,8 top sp.1,2

L 65

H 68 top sp.4
H 69 top sp.3
H 69,6 top sp.2,4
H 70 top sp.2
H 70,8 top sp.1,2

L 90

H 68 top sp.4
H 69 top sp.3
H 69,6 top sp.2,4
H 70 top sp.2
H 70,8 top sp.1,2

L 120

H 68 top sp.4
H 69 top sp.3
H 69,6 top sp.2,4
H 70 top sp.2
H 70,8 top sp.1,2

TYPE B1

L 60

H 65 worktop th.4
H 66 worktop th.3
H 66,6 worktop th.2,4
H 67 worktop th.2
H 67,8 worktop th.1,2

L 65

H 65 worktop th.4
H 66 worktop th.3
H 66,6 worktop th.2,4
H 67 worktop th.2
H 67,8 worktop th.1,2

L 90

H 65 worktop th.4
H 66 worktop th.3
H 66,6 worktop th.2,4
H 67 worktop th.2
H 67,8 worktop th.1,2

L 120

H 65 worktop th.4
H 66 worktop th.3
H 66,6 worktop th.2,4
H 67 worktop th.2
H 67,8 worktop th.1,2

TYPE B2

L 60

H 68 worktop th.4
H 69 worktop th.3
H 69,6 worktop th.2,4
H 70 worktop th.2
H 70,8 worktop th.1,2

L 65

H 68 worktop th.4
H 69 worktop th.3
H 69,6 worktop th.2,4
H 70 worktop th.2
H 70,8 worktop th.1,2

L 90

H 68 worktop th.4
H 69 worktop th.3
H 69,6 worktop th.2,4
H 70 worktop th.2
H 70,8 worktop th.1,2

L 120

H 68 worktop th.4
H 69 worktop th.3
H 69,6 worktop th.2,4
H 70 worktop th.2
H 70,8 worktop th.1,2

CODICE
CODE No.

ACCIAIO
STEEL

TITANIO
TITANIUM

BRUNITO
BURNISHED

086MC3160
086MC3360
086MC3560
086MC3760
086MC3960

086MC3165
086MC3365
086MC3565
086MC3765
086MC3965

086MC3190
086MC3390
086MC3590
086MC3790
086MC3990

086MC3195
086MC3395
086MC3595
086MC3795
086MC3995

086MC4160
086MC4360
086MC4560
086MC4760
086MC4960

086MC4165
086MC4365
086MC4565
086MC4765
086MC4965

086MC4190
086MC4390
086MC4590
086MC4790
086MC4990

086MC4195
086MC4395
086MC4595
086MC4795
086MC4995

SCHIENALI FENIX

FENIX BACK PANELS

SCHIENALI EFFETTO MARMO

EFFECT MARBLE BACK PANELS

SCHIENALI IMPIALLACCIATI WOOD

N.B.: non utilizzati per gli elementi da 120

WOOD VENEERED BACK PANELS

Note: not used for 120 elements

Finiture "MODULAR"

"MODULAR" finishes

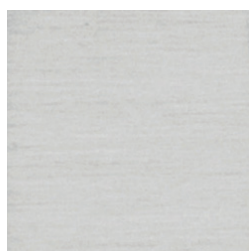

Acciaio (opz.A)
Stainless Steel



Titanio (opz.T)
Titanium



Brunito (opz.B)
Burnished

MODULAR CON SCHIENALE

MODULAR WITH BACK PANEL

Modulo cm 60-90-120 P 15,3
in appoggio con cielo e 2 ripiani.

Lean on rack element
cm 60-90-120 D 15,3
with top panel and 2 shelves.

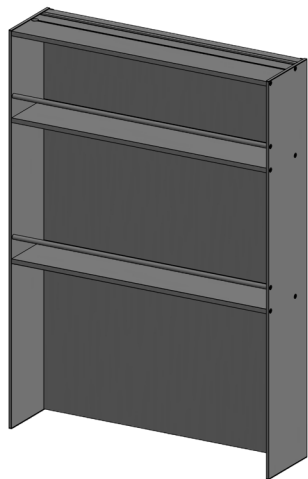

TIPO C1

L 60

H 77 top sp.4
H 78 top sp.3
H 78,6 top sp.2,4
H 79 top sp.2
H 79,8 top sp.1,2

L 65

H 77 top sp.4
H 78 top sp.3
H 78,6 top sp.2,4
H 79 top sp.2
H 79,8 top sp.1,2

L 90

H 77 top sp.4
H 78 top sp.3
H 78,6 top sp.2,4
H 79 top sp.2
H 79,8 top sp.1,2

L 120

H 77 top sp.4
H 78 top sp.3
H 78,6 top sp.2,4
H 79 top sp.2
H 79,8 top sp.1,2

TIPO C2

L 60

H 80 top sp.4
H 81 top sp.3
H 81,6 top sp.2,4
H 82 top sp.2
H 82,8 top sp.1,2

L 65

H 80 top sp.4
H 81 top sp.3
H 81,6 top sp.2,4
H 82 top sp.2
H 82,8 top sp.1,2

L 90

H 80 top sp.4
H 81 top sp.3
H 81,6 top sp.2,4
H 82 top sp.2
H 82,8 top sp.1,2

L 120

H 80 top sp.4
H 81 top sp.3
H 81,6 top sp.2,4
H 82 top sp.2
H 82,8 top sp.1,2

TYPE C1

L 60

H 77 worktop th.4
H 78 worktop th.3
H 78,6 worktop th.2,4
H 79 worktop th.2
H 79,8 worktop th.1,2

L 65

H 77 worktop th.4
H 78 worktop th.3
H 78,6 worktop th.2,4
H 79 worktop th.2
H 79,8 worktop th.1,2

L 90

H 77 worktop th.4
H 78 worktop th.3
H 78,6 worktop th.2,4
H 79 worktop th.2
H 79,8 worktop th.1,2

L 120

H 77 worktop th.4
H 78 worktop th.3
H 78,6 worktop th.2,4
H 79 worktop th.2
H 79,8 worktop th.1,2

TYPE C2

L 60

H 80 worktop th.4
H 81 worktop th.3
H 81,6 worktop th.2,4
H 82 worktop th.2
H 82,8 worktop th.1,2

L 60

H 80 worktop th.4
H 81 worktop th.3
H 81,6 worktop th.2,4
H 82 worktop th.2
H 82,8 worktop th.1,2

L 90

H 80 worktop th.4
H 81 worktop th.3
H 81,6 worktop th.2,4
H 82 worktop th.2
H 82,8 worktop th.1,2

L 120

H 80 worktop th.4
H 81 worktop th.3
H 81,6 worktop th.2,4
H 82 worktop th.2
H 82,8 worktop th.1,2

CODICE
CODE No.

ACCIAIO
STEEL

TITANIO
TITANIUM

BRUNITO
BURNISHED

086MC5160
086MC5360
086MC5560
086MC5760
086MC5960

086MC5165
086MC5365
086MC5565
086MC5765
086MC5965

086MC5190
086MC5390
086MC5590
086MC5790
086MC5990

086MC5195
086MC5395
086MC5595
086MC5795
086MC5995

086MC6160
086MC6360
086MC6560
086MC6760
086MC6960

086MC6165
086MC6365
086MC6565
086MC6765
086MC6965

086MC6190
086MC6390
086MC6590
086MC6790
086MC6990

086MC6195
086MC6395
086MC6595
086MC6795
086MC6995

SCHIENALI FENIX

FENIX BACK PANELS

SCHIENALI EFFETTO MARMO

EFFECT MARBLE BACK PANELS

SCHIENALI IMPIALLACCIATI WOOD

WOOD VENEERED BACK PANELS

Finiture "MODULAR"

"MODULAR" finishes



Acciaio (opz.A)
Stainless Steel



Titanio (opz.T)
Titanium



Brunito (opz.B)
Burnished

MODULAR CON SCHIENALE

MODULAR WITH BACK PANEL

Modulo cm 60-90-120 P 15,3
in appoggio con cielo e 2 ripiani.

Lean on rack element
cm 60-90-120 D 15,3
with top panel and 2 shelves.

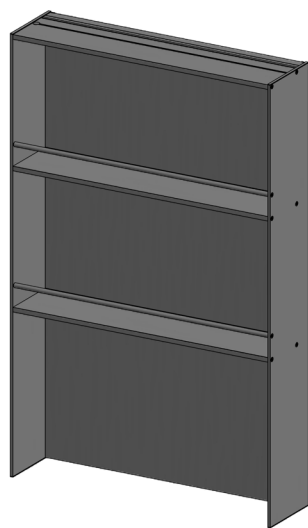

SCHIENALI FENIX
FENIX BACK PANELS

SCHIENALI EFFETTO MARMO
EFFECT MARBLE BACK PANELS

SCHIENALI IMPIALLACCIATI WOOD

WOOD VENEERED BACK PANELS

TIPO D1

L 60

H 89 top sp.4
H 90 top sp.3
H 90,6 top sp.2,4
H 91 top sp.2
H 91,8 top sp.1,2

L 65

H 89 top sp.4
H 90 top sp.3
H 90,6 top sp.2,4
H 91 top sp.2
H 91,8 top sp.1,2

L 90

H 89 top sp.4
H 90 top sp.3
H 90,6 top sp.2,4
H 91 top sp.2
H 91,8 top sp.1,2

L 120

H 89 top sp.4
H 90 top sp.3
H 90,6 top sp.2,4
H 91 top sp.2
H 91,8 top sp.1,2

TIPO D2

L 60

H 92 top sp.4
H 93 top sp.3
H 93,6 top sp.2,4
H 94 top sp.2
H 94,8 top sp.1,2

L 65

H 92 top sp.4
H 93 top sp.3
H 93,6 top sp.2,4
H 94 top sp.2
H 94,8 top sp.1,2

L 90

H 92 top sp.4
H 93 top sp.3
H 93,6 top sp.2,4
H 94 top sp.2
H 94,8 top sp.1,2

L 120

H 92 top sp.4
H 93 top sp.3
H 93,6 top sp.2,4
H 94 top sp.2
H 94,8 top sp.1,2

TYPE D1

L 60

H 89 worktop th.4
H 90 worktop th.3
H 90,6 worktop th.2,4
H 91 worktop th.2
H 91,8 worktop th.1,2

L 65

H 89 worktop th.4
H 90 worktop th.3
H 90,6 worktop th.2,4
H 91 worktop th.2
H 91,8 worktop th.1,2

L 90

H 89 worktop th.4
H 90 worktop th.3
H 90,6 worktop th.2,4
H 91 worktop th.2
H 91,8 worktop th.1,2

L 120

H 89 worktop th.4
H 90 worktop th.3
H 90,6 worktop th.2,4
H 91 worktop th.2
H 91,8 worktop th.1,2

TYPE D2

L 60

H 92 worktop th.4
H 93 worktop th.3
H 93,6 worktop th.2,4
H 94 worktop th.2
H 94,8 worktop th.1,2

L 65

H 92 worktop th.4
H 93 worktop th.3
H 93,6 worktop th.2,4
H 94 worktop th.2
H 94,8 worktop th.1,2

L 90

H 92 worktop th.4
H 93 worktop th.3
H 93,6 worktop th.2,4
H 94 worktop th.2
H 94,8 worktop th.1,2

L 120

H 92 worktop th.4
H 93 worktop th.3
H 93,6 worktop th.2,4
H 94 worktop th.2
H 94,8 worktop th.1,2

CODICE
CODE No.

ACCIAIO
STEEL

TITANIO
TITANIUM

BRUNITO
BURNISHED

086MD1160
086MD1360
086MD1560
086MD1760
086MD1960

086MD1165
086MD1365
086MD1565
086MD1765
086MD1965

086MD1190
086MD1390
086MD1590
086MD1790
086MD1990

086MD1195
086MD1395
086MD1595
086MD1795
086MD1995

086MD2160
086MD2360
086MD2560
086MD2760
086MD2960

086MD2165
086MD2365
086MD2565
086MD2765
086MD2965

086MD2190
086MD2390
086MD2590
086MD2790
086MD2990

086MD2195
086MD2395
086MD2595
086MD2795
086MD2995

Finiture "MODULAR"

"MODULAR" finishes

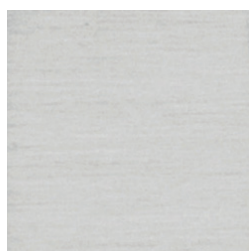

Acciaio (opz.A)
Stainless Steel



Titanio (opz.T)
Titanium



Brunito (opz.B)
Burnished

MODULAR CON SCHIENALE

MODULAR WITH BACK PANEL

Modulo cm 60-90-120 P 15,3
in appoggio con cielo e 2 ripiani.

Lean on rack element
cm 60-90-120 D 15,3
with top panel and 2 shelves.

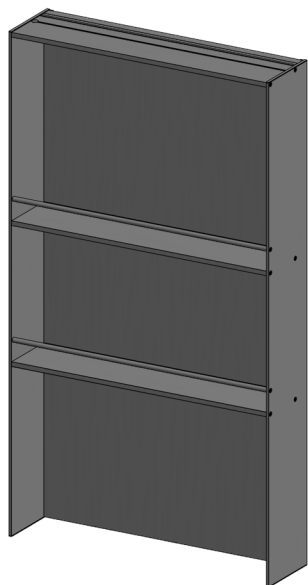

TIPO E1

L 60

H 101 top sp.4
H 102 top sp.3
H 102,6 top sp.2,4
H 103 top sp.2
H 103,8 top sp.1,2

L 65

H 101 top sp.4
H 102 top sp.3
H 102,6 top sp.2,4
H 103 top sp.2
H 103,8 top sp.1,2

L 90

H 101 top sp.4
H 102 top sp.3
H 102,6 top sp.2,4
H 103 top sp.2
H 103,8 top sp.1,2

L 120

H 101 top sp.4
H 102 top sp.3
H 102,6 top sp.2,4
H 103 top sp.2
H 103,8 top sp.1,2

TYPE E1

L 60

H 101 worktop th.4
H 102 worktop th.3
H 102,6 worktop th.2,4
H 103 worktop th.2
H 103,8 worktop th.1,2

L 65

H 101 worktop th.4
H 102 worktop th.3
H 102,6 worktop th.2,4
H 103 worktop th.2
H 103,8 worktop th.1,2

L 90

H 101 worktop th.4
H 102 worktop th.3
H 102,6 worktop th.2,4
H 103 worktop th.2
H 103,8 worktop th.1,2

L 120

H 101 worktop th.4
H 102 worktop th.3
H 102,6 worktop th.2,4
H 103 worktop th.2
H 103,8 worktop th.1,2

CODICE
CODE No.

ACCIAIO
STEEL

TITANIO
TITANIUM

BRUNITO
BURNISHED

086MD3160
086MD3360
086MD3560
086MD3760
086MD3960

086MD3165
086MD3365
086MD3565
086MD3765
086MD3965

086MD3190
086MD3390
086MD3590
086MD3790
086MD3990

086MD3195
086MD3395
086MD3595
086MD3795
086MD3995

SCHIENALI FENIX
FENIX BACK PANELS

SCHIENALI EFFETTO MARMO
EFFECT MARBLE BACK PANELS

SCHIENALI IMPIALLACCIATI WOOD
WOOD VENEERED BACK PANELS

TIPO E2

L 60

H 104 top sp.4
H 105 top sp.3
H 105,6 top sp.2,4
H 106 top sp.2
H 106,8 top sp.1,2

L 65

H 104 top sp.4
H 105 top sp.3
H 105,6 top sp.2,4
H 106 top sp.2
H 106,8 top sp.1,2

L 90

H 104 top sp.4
H 105 top sp.3
H 105,6 top sp.2,4
H 106 top sp.2
H 106,8 top sp.1,2

L 120

H 104 top sp.4
H 105 top sp.3
H 105,6 top sp.2,4
H 106 top sp.2
H 106,8 top sp.1,2

TYPE E2

L 60

H 104 worktop th.4
H 105 worktop th.3
H 105,6 worktop th.2,4
H 106 worktop th.2
H 106,8 worktop th.1,2

L 65

H 104 worktop th.4
H 105 worktop th.3
H 105,6 worktop th.2,4
H 106 worktop th.2
H 106,8 worktop th.1,2

L 90

H 104 worktop th.4
H 105 worktop th.3
H 105,6 worktop th.2,4
H 106 worktop th.2
H 106,8 worktop th.1,2

L 120

H 104 worktop th.4
H 105 worktop th.3
H 105,6 worktop th.2,4
H 106 worktop th.2
H 106,8 worktop th.1,2

086MD4160
086MD4360
086MD4560
086MD4760
086MD4960

086MD4165
086MD4365
086MD4565
086MD4765
086MD4965

086MD4190
086MD4390
086MD4590
086MD4790
086MD4990

086MD4195
086MD4395
086MD4595
086MD4795
086MD4995



MODULAR CON SCHIENALE

MODULAR WITH BACK PANEL

Modulo cm 60-90 P 15,3
in appoggio con cielo e 3 ripiani.

Lean on rack element
cm 60-90 D 15,3
with top panel and 3 shelves.

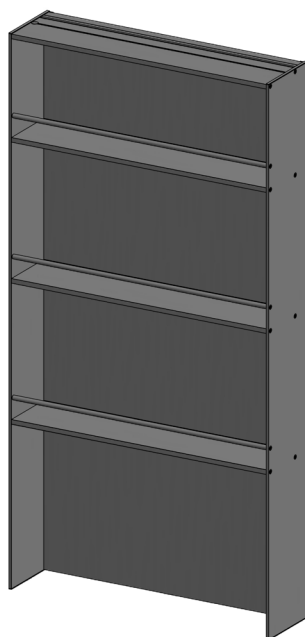

TIPO F1

L 60

H 125 top sp.4
H 126 top sp.3
H 126,6 top sp.2,4
H 127 top sp.2
H 127,8 top sp.1,2

L 65

H 125 top sp.4
H 126 top sp.3
H 126,6 top sp.2,4
H 127 top sp.2
H 127,8 top sp.1,2

L 90

H 125 top sp.4
H 126 top sp.3
H 126,6 top sp.2,4
H 127 top sp.2
H 127,8 top sp.1,2

TYPE F1

L 60

H 125 worktop th.4
H 126 worktop th.3
H 126,6 worktop th.2,4
H 127 worktop th.2
H 127,8 worktop th.1,2

L 65

H 125 worktop th.4
H 126 worktop th.3
H 126,6 worktop th.2,4
H 127 worktop th.2
H 127,8 worktop th.1,2

L 90

H 125 worktop th.4
H 126 worktop th.3
H 126,6 worktop th.2,4
H 127 worktop th.2
H 127,8 worktop th.1,2

TIPO F2

L 60

H 128 top sp.4
H 129 top sp.3
H 129,6 top sp.2,4
H 130 top sp.2
H 130,8 top sp.1,2

L 65

H 128 top sp.4
H 129 top sp.3
H 129,6 top sp.2,4
H 130 top sp.2
H 130,8 top sp.1,2

L 90

H 128 top sp.4
H 129 top sp.3
H 129,6 top sp.2,4
H 130 top sp.2
H 130,8 top sp.1,2

TYPE F2

L 60

H 128 worktop th.4
H 129 worktop th.3
H 129,6 worktop th.2,4
H 130 worktop th.2
H 130,8 worktop th.1,2

L 65

H 128 worktop th.4
H 129 worktop th.3
H 129,6 worktop th.2,4
H 130 worktop th.2
H 130,8 worktop th.1,2

L 90

H 128 worktop th.4
H 129 worktop th.3
H 129,6 worktop th.2,4
H 130 worktop th.2
H 130,8 worktop th.1,2

CODICE
CODE No.

ACCIAIO
STEEL

TITANIO
TITANIUM

BRUNITO
BURNISHED

086MC7160
086MC7360
086MC7560
086MC7760
086MC7960

086MC7165
086MC7365
086MC7565
086MC7765
086MC7965

086MC7190
086MC7390
086MC7590
086MC7790
086MC7990

086MC8160
086MC8360
086MC8560
086MC8760
086MC8960

086MC8165
086MC8365
086MC8565
086MC8765
086MC8965

086MC8190
086MC8390
086MC8590
086MC8790
086MC8990

SCHIENALI FENIX
FENIX BACK PANELS

SCHIENALI EFFETTO MARMO
EFFECT MARBLE BACK PANELS

SCHIENALI IMPIALLACCIATI WOOD
WOOD VENEERED BACK PANELS

Finiture "MODULAR"

"MODULAR" finishes

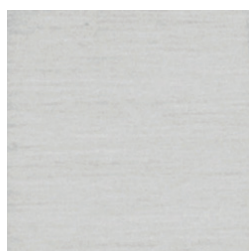

Acciaio (opz.A)
Stainless Steel



Titanio (opz.T)
Titanium



Brunito (opz.B)
Burnished

MODULAR SOSPESO CON SCHIENALE

MODULAR SUSPENDED WITH BACK PANEL

Modulo H 132 P 15,3
sospeso con cielo e 4 ripiani.

Hanging rack element
 H 132 D 15,3
 with top panel and 4 shelves.

CODICE
CODE No.

ACCIAIO
 STEEL

TITANIO
 TITANIUM

BRUNITO
 BURNISHED

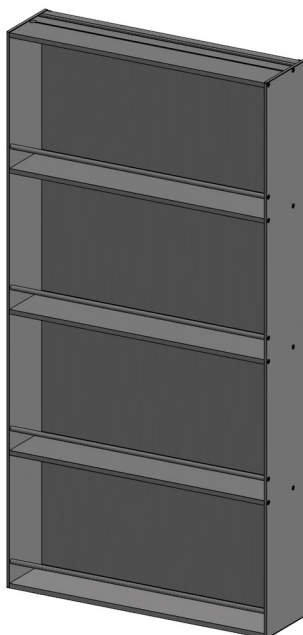

SCHIENALI FENIX
 FENIX BACK PANELS

SCHIENALI EFFETTO MARMO
 EFFECT MARBLE BACK PANELS

SCHIENALI IMPIALLACCIATI WOOD
 WOOD VENEERED BACK PANELS

L 60
 L 90

W 60
 W 90

086MD9060
086MD9090

Finiture "MODULAR"

"MODULAR" finishes



Acciaio (opz.A)
 Stainless Steel



Titanio (opz.T)
 Titanium



Brunito (opz.B)
 Burnished

MODULAR SCHIENALI CON LUCE DUAL COLOR

MODULAR BACK PANELS WITH DUAL COLOR LIGHT



MODULAR COLORI SCHIENALI

MODULAR COLOURS BACK PANELS

COLORI MELAMICI MODELLO IMMAGINA PLUS

IMMAGINA PLUS MODEL MELAMINE COLOURS

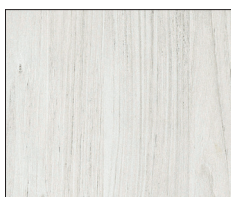

cansiglio bianco
(opz.1561)
white cansiglio

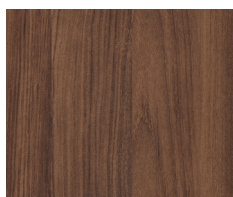

cansiglio terra bruciata
(opz.1562)
scorched earth cansiglio



cansiglio grigio fumo
(opz.1563)
smoke grey cansiglio



cansiglio sabbia
(opz.1564)
sand cansiglio



cansiglio champagne
(opz.1565)
champagne cansiglio



larice baglia
(opz.1826)
baglia larch

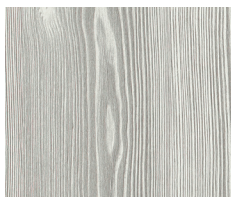

larice laguna
(opz.1827)
lagoon larch



larice vulcano
(opz.1828)
volcano larch

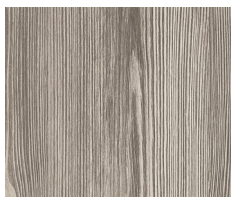

larice terra
(opz.1829)
earth larch

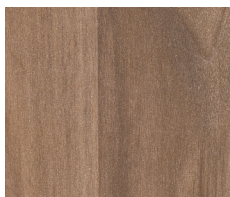

noce
(opz.2363)
walnut



cemento
(opz.9633)
cement



bianco cristallo
(opz.7445)
cristal white



grigio nebbia
(opz.9626)
fog grey



castoro
(opz.8862)
beaver

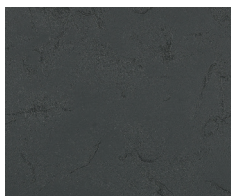

lavagna
(opz.9627)
slate grey



juta
(opz.8863)
jute

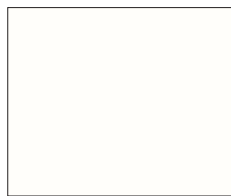

bianco assoluto
(opz.7441)
absolute white

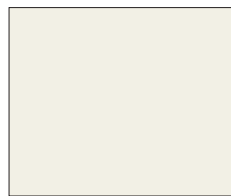

bianco neve
(opz.7450)
snow white



grigio sasso
(opz.9650)
pebble grey



verde marino
(opz.8402)
sea green

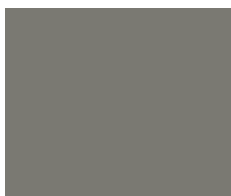

grigio monson
(opz.9651)
monsoon grey



grigio notte
(opz.9652)
midnight grey



grigio velo
(opz.9653)
veil grey

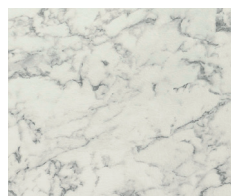

marmo baron
(opz.9632)
baron marble



nicel
(opz.9660)
nickel

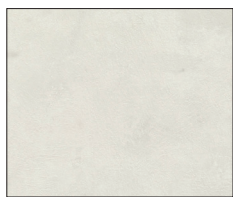

platino
(opz.9661)
platinum



zinco
(opz.9662)
zinc



peltro
(opz.9666)
pewter



titanio
(opz.9665)
titanium



olmo bianco
(opz.5001)
white elm



olmo antracite
(opz.5004)
anthracite elm

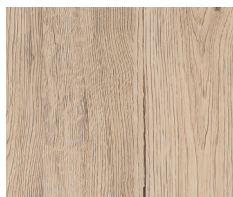

oak miele
(opz.1361)
honey oak



oak neve
(opz.1362)
snow oak



oak cognac
(opz.1363)
cognac oak

MODULAR COLORI SCHIENALI

MODULAR COLOURS BACK PANELS

COLORI MELAMICI MODELLO TABLET - JEY FEEL - SMART TABLET - JEY FEEL - SMART MODEL MELAMINE COLOURS



rovere luna
(opz.5316)
moon oak

rovere venere
(opz.5315)
venus oak

rovere arizona
(opz.5317)
arizona oak

rovere dark
(opz.5318)
dark oak

frassino lava
(opz.2408)
lava ash

frassino sabbia
(opz.2406)
sand ash

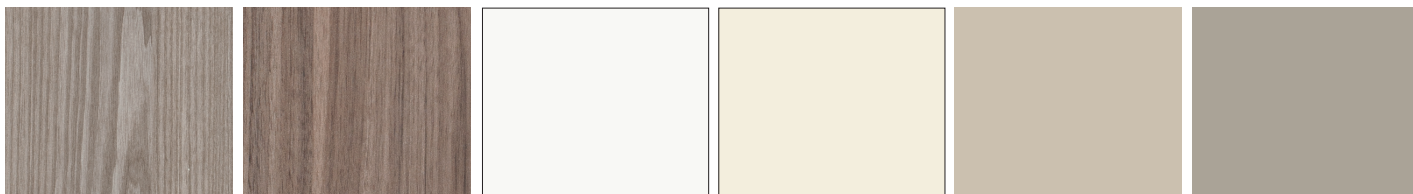

frassino pietra
(opz.2407)
stone ash

noce brown
(opz.2371)
brown walnut

bianco soft matt
(opz.7447N)
soft matt white

porcellana soft matt
(opz.7703N)
soft matt porcelain

desert soft matt
(opz.8914N)
soft matt desert

molaria soft matt
(opz.9636N)
soft matt molaria



arena soft matt (opz.9637N)
soft matt arena

bianco
(opz.9639)
white

bronzo
(opz.8866)
bronze

ardesia
(opz.9638)
slate grey

rovere silver
(opz.5306)
silver oak

rovere diamond
(opz.5307)
diamond oak



rovere tabià
(opz.5309)
tabià oak

rovere ortisei
(opz.5305)
ortisei oak

trani
(opz.7704)
trani

black
(opz.7863)
black

white
(opz.7448)
white

grigio agata
(opz.9623)
agata grey

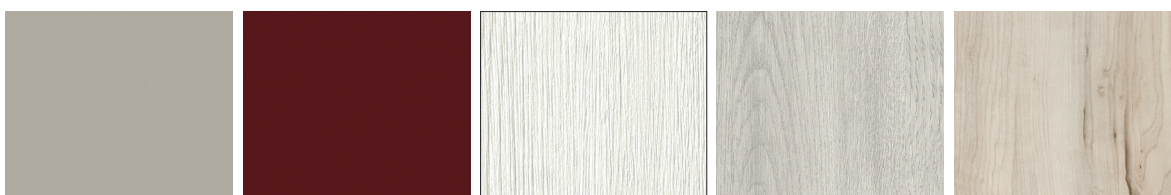

grigio inox
(opz.9624)
stainless steel grey

rosso cardinale
(opz.8123)
cardinal red

frassino bianco alpino
(opz.2310)
alpine-white ash

rovere greige
(opz.2320)
greige oak

betulla
(opz.2311)
birch

COLORI STRUTTURE CARCASSES COLOURS



bianco (opz.001)
white

visone (opz.948M)
mink

lavagna (opz.9620)
slate grey

fango (opz.8860)
mud

conchiglia (opz.8910)
shell

argilla (opz.9690)
clay

MODULAR COLORI SCHIENALI

MODULAR COLOURS BACK PANELS

COLORI FENIX

FENIX COLOURS

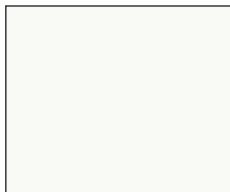

bianco caldo
(opz.0032)
warm white



castoro
(opz.0717)
beaver

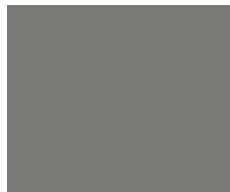

fumo
(opz.0718)
smoke



nero
(opz.0720)
black

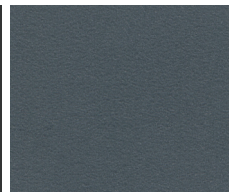

grigio bromo
(opz.0724)
bromine grey

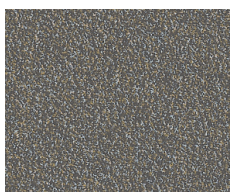

bronzo doha
(opz.2629)
doha bronze



beige arizona
(opz.0748)
arizona beige



cacao orinoco
(opz.0749)
orinoco cocoa



rosso jaipur
(opz.0751)
jaipur red



verde commodoro
(opz.0750)
commodoro green



grigio antrim
(opz.0752)
antrim grey

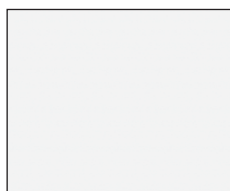

bianco dover
(opz.0757)
dover white



grigio efeso
(opz.0725)
ephesus grey

COLORI EFFETTO MARMO

MARBLE EFFECT COLOURS

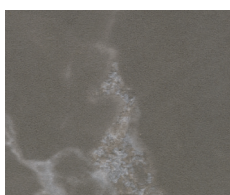

perlato finitura ker
(opz.3443)
pearly with ker finish

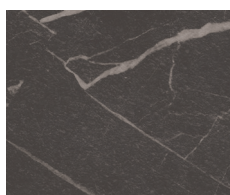

alabastro finitura mn
(opz.6014)
alabaster with mn finish



calacatta finitura mn
(opz.6019)
calacatta with mn finish

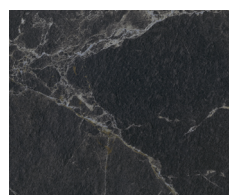

dark finitura mn
(opz.6133)
dark with mn finish

COLORI WOOD IMPIALLACCIATO MODELLO IMMAGINA - TABLET

IMMAGINA - TABLET MODEL VENEERED COLOURS

N.B: non utilizzati per gli elementi da 120

Note: not used for 120 elements

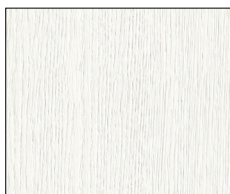

rovere bianco
(opz.5441)
white oak

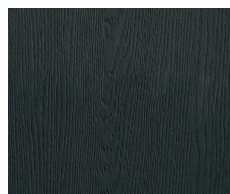

rovere nero
(opz.5446)
black oak

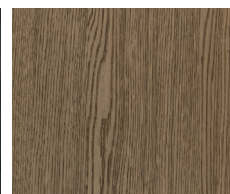

rovere moscato
(opz.5444)
muscat oak

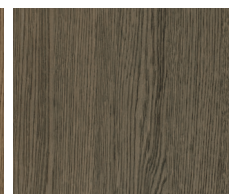

rovere fumè
(opz.5445)
smoked oak

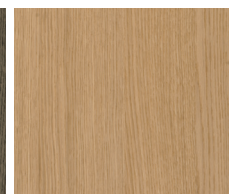

rovere naturale
(opz.5442)
natural oak

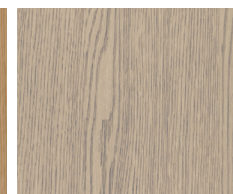

rovere grey
(opz.5443)
grey oak

MODULAR CON SCHIENALE E LUCE DUAL COLOR

MODULAR WITH BACK PANEL AND DUAL COLOR LIGHT

Modulo cm 60-90-120 P 15,2
in appoggio con cielo e ripiano.
N.B.: kit dual color incluso

Lean on rack element
 cm 60-90-120 D 15,2
 with top panel and shelf.
 Note: kit dual colours
 included

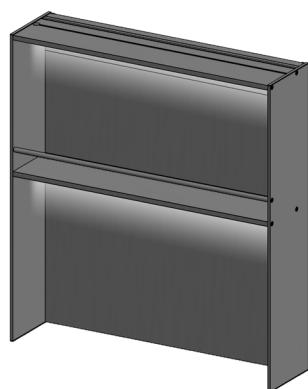

SCHIENALI FENIX

FENIX BACK PANELS

SCHIENALI EFFETTO MARMO

EFFECT MARBLE BACK PANELS

SCHIENALI IMPIALLACCIATI WOOD

WOOD VENEERED BACK PANELS

N.B.: inserire l'alimentatore corretto in base
all'assorbimento totale dato dalla somma degli elementi
inseriti nella composizione.
Vedi pagina 31

Note: insert the correct power supply in the base
to the total absorption given by the sum of the elements
included in the composition.
See page 31

TIPO B1

L 60 W14 Totali

H 65 top sp.4
 H 66 top sp.3
 H 66,6 top sp.2,4
 H 67 top sp.2
 H 67,8 top sp.1,2

L 65 W16 Totali

H 65 top sp.4
 H 66 top sp.3
 H 66,6 top sp.2,4
 H 67 top sp.2
 H 67,8 top sp.1,2

L 90 W20 Totali

H 65 top sp.4
 H 66 top sp.3
 H 66,6 top sp.2,4
 H 67 top sp.2
 H 67,8 top sp.1,2

L 120 W28 Totali

H 65 top sp.4
 H 66 top sp.3
 H 66,6 top sp.2,4
 H 67 top sp.2
 H 67,8 top sp.1,2

TIPO B2

L 60 W14 Totali

H 68 top sp.4
 H 69 top sp.3
 H 69,6 top sp.2,4
 H 70 top sp.2
 H 70,8 top sp.1,2

L 65 W16 Totali

H 68 top sp.4
 H 69 top sp.3
 H 69,6 top sp.2,4
 H 70 top sp.2
 H 70,8 top sp.1,2

L 90 W20 Totali

H 68 top sp.4
 H 69 top sp.3
 H 69,6 top sp.2,4
 H 70 top sp.2
 H 70,8 top sp.1,2

L 120 W28 Totali

H 68 top sp.4
 H 69 top sp.3
 H 69,6 top sp.2,4
 H 70 top sp.2
 H 70,8 top sp.1,2

TYPE B1

L 60 W14 Total

H 65 worktop th.4
 H 66 worktop th.3
 H 66,6 worktop th.2,4
 H 67 worktop th.2
 H 67,8 worktop th.1,2

L 65 W16 Total

H 65 worktop th.4
 H 66 worktop th.3
 H 66,6 worktop th.2,4
 H 67 worktop th.2
 H 67,8 worktop th.1,2

L 90 W20 Total

H 65 worktop th.4
 H 66 worktop th.3
 H 66,6 worktop th.2,4
 H 67 worktop th.2
 H 67,8 worktop th.1,2

L 120 W28 Total

H 65 worktop th.4
 H 66 worktop th.3
 H 66,6 worktop th.2,4
 H 67 worktop th.2
 H 67,8 worktop th.1,2

TYPE B2

L 60 W14 Total

H 68 worktop th.4
 H 69 worktop th.3
 H 69,6 worktop th.2,4
 H 70 worktop th.2
 H 70,8 worktop th.1,2

L 65 W16 Total

H 68 worktop th.4
 H 69 worktop th.3
 H 69,6 worktop th.2,4
 H 70 worktop th.2
 H 70,8 worktop th.1,2

L 90 W20 Total

H 68 worktop th.4
 H 69 worktop th.3
 H 69,6 worktop th.2,4
 H 70 worktop th.2
 H 70,8 worktop th.1,2

L 120 W28 Total

H 68 worktop th.4
 H 69 worktop th.3
 H 69,6 worktop th.2,4
 H 70 worktop th.2
 H 70,8 worktop th.1,2

CODICE
CODE No.

ACCIAIO
 STEEL

TITANIO
 TITANIUM

BRUNITO
 BURNISHED

086MCL3160
086MCL3360
086MCL3560
086MCL3760
086MCL3960

086MCL3165
086MCL3365
086MCL3565
086MCL3765
086MCL3965

086MCL3190
086MCL3390
086MCL3590
086MCL3790
086MCL3990

086MCL3195
086MCL3395
086MCL3595
086MCL3795
086MCL3995

086MCL4160
086MCL4360
086MCL4560
086MCL4760
086MCL4960

086MCL4165
086MCL4365
086MCL4565
086MCL4765
086MCL4965

086MCL4190
086MCL4390
086MCL4590
086MCL4790
086MCL4990

086MCL4195
086MCL4395
086MCL4595
086MCL4795
086MCL4995

Finiture "MODULAR"

"MODULAR" finishes



Acciaio (opz.A)
 Stainless Steel



Titanio (opz.T)
 Titanium



Brunito (opz.B)
 Burnished

MODULAR CON SCHIENALE E LUCE DUAL COLOR

MODULAR WITH BACK PANEL AND DUAL COLOR LIGHT

Modulo cm 60-90-120 P 15,2
in appoggio con cielo e 2 ripiani.
N.B.: kit dual color incluso

Lean on rack element
 cm 60-90-120 D 15,2
 with top panel and 2 shelves.
 Note: kit dual colours
 included

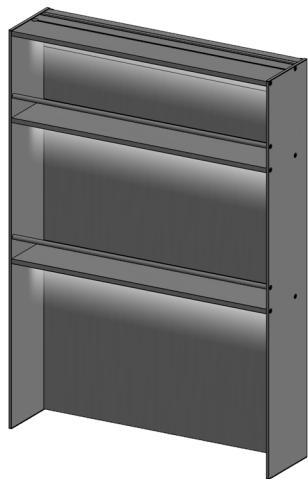

SCHIENALI FENIX
 FENIX BACK PANELS

SCHIENALI EFFETTO MARMO
 EFFECT MARBLE BACK PANELS

SCHIENALI IMPIALLACCIATI WOOD

WOOD VENEERED BACK PANELS

N.B.: inserire l'alimentatore corretto in base
all'assorbimento totale dato dalla somma degli elementi
inseriti nella composizione.
Vedi pagina 31

Note: insert the correct power supply in the base
to the total absorption given by the sum of the elements
included in the composition.
See page 31

TIPO C1

L 60 W21 Totali
 H 77 top sp.4
 H 78 top sp.3
 H 78,6 top sp.2,4
 H 79 top sp.2
 H 79,8 top sp.1,2

L 65 W24 Totali
 H 77 top sp.4
 H 78 top sp.3
 H 78,6 top sp.2,4
 H 79 top sp.2
 H 79,8 top sp.1,2

L 90 W30 Totali
 H 77 top sp.4
 H 78 top sp.3
 H 78,6 top sp.2,4
 H 79 top sp.2
 H 79,8 top sp.1,2

L 120 W42 Totali
 H 77 top sp.4
 H 78 top sp.3
 H 78,6 top sp.2,4
 H 79 top sp.2
 H 79,8 top sp.1,2

TIPO C2

L 60 W21 Totali
 H 80 top sp.4
 H 81 top sp.3
 H 81,6 top sp.2,4
 H 82 top sp.2
 H 82,8 top sp.1,2

L 65 W24 Totali
 H 80 top sp.4
 H 81 top sp.3
 H 81,6 top sp.2,4
 H 82 top sp.2
 H 82,8 top sp.1,2

L 90 W30 Totali
 H 80 top sp.4
 H 81 top sp.3
 H 81,6 top sp.2,4
 H 82 top sp.2
 H 82,8 top sp.1,2

L 120 W42 Totali
 H 80 top sp.4
 H 81 top sp.3
 H 81,6 top sp.2,4
 H 82 top sp.2
 H 82,8 top sp.1,2

TYPE C1

L 60 W21 Total
 H 77 worktop th.4
 H 78 worktop th.3
 H 78,6 worktop th.2,4
 H 79 worktop th.2
 H 79,8 worktop th.1,2

L 65 W24 Total
 H 77 worktop th.4
 H 78 worktop th.3
 H 78,6 worktop th.2,4
 H 79 worktop th.2
 H 79,8 worktop th.1,2

L 90 W30 Total
 H 77 worktop th.4
 H 78 worktop th.3
 H 78,6 worktop th.2,4
 H 79 worktop th.2
 H 79,8 worktop th.1,2

L 120 W42 Total
 H 77 worktop th.4
 H 78 worktop th.3
 H 78,6 worktop th.2,4
 H 79 worktop th.2
 H 79,8 worktop th.1,2

TYPE C2

L 60 W21 Total
 H 80 worktop th.4
 H 81 worktop th.3
 H 81,6 worktop th.2,4
 H 82 worktop th.2
 H 82,8 worktop th.1,2

L 65 W24 Total
 H 80 worktop th.4
 H 81 worktop th.3
 H 81,6 worktop th.2,4
 H 82 worktop th.2
 H 82,8 worktop th.1,2

L 90 W30 Total
 H 80 worktop th.4
 H 81 worktop th.3
 H 81,6 worktop th.2,4
 H 82 worktop th.2
 H 82,8 worktop th.1,2

L 120 W42 Total
 H 80 worktop th.4
 H 81 worktop th.3
 H 81,6 worktop th.2,4
 H 82 worktop th.2
 H 82,8 worktop th.1,2

CODICE
CODE No.

ACCIAIO
 STEEL

TITANIO
 TITANIUM

BRUNITO
 BURNISHED

086MCL5160
086MCL5360
086MCL5560
086MCL5760
086MCL5960

086MCL5165
086MCL5365
086MCL5565
086MCL5765
086MCL5965

086MCL5190
086MCL5390
086MCL5590
086MCL5790
086MCL5990

086MCL5195
086MCL5395
086MCL5595
086MCL5795
086MCL5995

086MCL6160
086MCL6360
086MCL6560
086MCL6760
086MCL6960

086MCL6165
086MCL6365
086MCL6565
086MCL6765
086MCL6965

086MCL6190
086MCL6390
086MCL6590
086MCL6790
086MCL6990

086MCL6195
086MCL6395
086MCL6595
086MCL6795
086MCL6995

Finiture "MODULAR"

"MODULAR" finishes



Acciaio (opz.A)
 Stainless Steel



Titanio (opz.T)
 Titanium



Brunito (opz.B)
 Burnished

MODULAR CON SCHIENALE E LUCE DUAL COLOR

MODULAR WITH BACK PANEL AND DUAL COLOR LIGHT

**Modulo cm 60-90-120 P 15,2
in appoggio con cielo e 2 ripiani.**
N.B.: kit dual color incluso

Lean on rack element
cm 60-90-120 D 15,2
with top panel and 2 shelves.
**Note: kit dual colours
included**

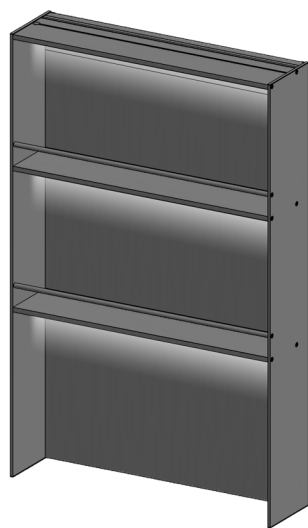

SCHIENALI FENIX
FENIX BACK PANELS

SCHIENALI EFFETTO MARMO
EFFECT MARBLE BACK PANELS

SCHIENALI IMPIALLACCIATI WOOD
WOOD VENEERED BACK PANELS

WOOD VENEERED BACK PANELS

**N.B.: inserire l'alimentatore corretto in base
all'assorbimento totale dato dalla somma degli elementi
inseriti nella composizione.**
Vedi pagina 31

**Note: insert the correct power supply in the base
to the total absorption given by the sum of the elements
included in the composition.**
See page 31

TIPO D1

L 60 W21 Totali
H 89 top sp.4
H 90 top sp.3
H 90,6 top sp.2,4
H 91 top sp.2
H 91,8 top sp.1,2

L 65 W24 Totali
H 89 top sp.4
H 90 top sp.3
H 90,6 top sp.2,4
H 91 top sp.2
H 91,8 top sp.1,2

L 90 W30 Totali
H 89 top sp.4
H 90 top sp.3
H 90,6 top sp.2,4
H 91 top sp.2
H 91,8 top sp.1,2

L 120 W42 Totali
H 89 top sp.4
H 90 top sp.3
H 90,6 top sp.2,4
H 91 top sp.2
H 91,8 top sp.1,2

TIPO D2

L 60 W21 Totali
H 92 top sp.4
H 93 top sp.3
H 93,6 top sp.2,4
H 94 top sp.2
H 94,8 top sp.1,2

L 65 W24 Totali
H 92 top sp.4
H 93 top sp.3
H 93,6 top sp.2,4
H 94 top sp.2
H 94,8 top sp.1,2

L 90 W30 Totali
H 92 top sp.4
H 93 top sp.3
H 93,6 top sp.2,4
H 94 top sp.2
H 94,8 top sp.1,2

L 120 W42 Totali
H 92 top sp.4
H 93 top sp.3
H 93,6 top sp.2,4
H 94 top sp.2
H 94,8 top sp.1,2

TYPE D1

L 60 W21 Total
H 89 worktop th.4
H 90 worktop th.3
H 90,6 worktop th.2,4
H 91 worktop th.2
H 91,8 worktop th.1,2

L 65 W24 Total
H 89 worktop th.4
H 90 worktop th.3
H 90,6 worktop th.2,4
H 91 worktop th.2
H 91,8 worktop th.1,2

L 90 W30 Total
H 89 worktop th.4
H 90 worktop th.3
H 90,6 worktop th.2,4
H 91 worktop th.2
H 91,8 worktop th.1,2

L 120 W42 Total
H 89 worktop th.4
H 90 worktop th.3
H 90,6 worktop th.2,4
H 91 worktop th.2
H 91,8 worktop th.1,2

TYPE D2

L 60 W21 Total
H 92 worktop th.4
H 93 worktop th.3
H 93,6 worktop th.2,4
H 94 worktop th.2
H 94,8 worktop th.1,2

L 65 W24 Total
H 92 worktop th.4
H 93 worktop th.3
H 93,6 worktop th.2,4
H 94 worktop th.2
H 94,8 worktop th.1,2

L 90 W30 Total
H 92 worktop th.4
H 93 worktop th.3
H 93,6 worktop th.2,4
H 94 worktop th.2
H 94,8 worktop th.1,2

L 120 W42 Total
H 92 worktop th.4
H 93 worktop th.3
H 93,6 worktop th.2,4
H 94 worktop th.2
H 94,8 worktop th.1,2

**CODICE
CODE No.**

ACCIAIO
STEEL

TITANIO
TITANIUM

BRUNITO
BURNISHED

086MDL1160
086MDL1360
086MDL1560
086MDL1760
086MDL1960

086MDL1165
086MDL1365
086MDL1565
086MDL1765
086MDL1965

086MDL1190
086MDL1390
086MDL1590
086MDL1790
086MDL1990

086MDL1195
086MDL1395
086MDL1595
086MDL1795
086MDL1995

086MDL2160
086MDL2360
086MDL2560
086MDL2760
086MDL2960

086MDL2165
086MDL2365
086MDL2565
086MDL2765
086MDL2965

086MDL2190
086MDL2390
086MDL2590
086MDL2790
086MDL2990

086MDL2195
086MDL2395
086MDL2595
086MDL2795
086MDL2995

Finiture "MODULAR"

"MODULAR" finishes



Acciaio (opz.A)
Stainless Steel



Titanio (opz.T)
Titanium



Brunito (opz.B)
Burnished

MODULAR CON SCHIENALE E LUCE DUAL COLOR

MODULAR WITH BACK PANEL AND DUAL COLOR LIGHT

Modulo cm 60-90-120 P 15,2
in appoggio con cielo e 2 ripiani.
N.B.: kit dual color incluso

Lean on rack element
 cm 60-90-120 D 15,2
 with top panel and 2 shelves.
 Note: kit dual colours
 included

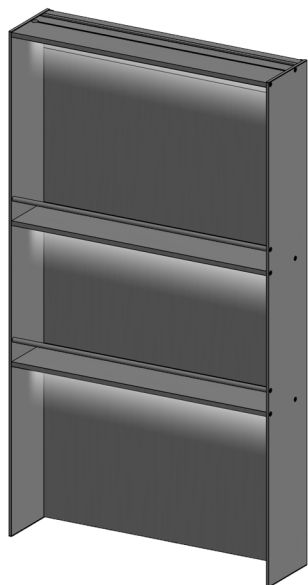

SCHIENALI FENIX
 FENIX BACK PANELS

SCHIENALI EFFETTO MARMO
 EFFECT MARBLE BACK PANELS

SCHIENALI IMPIALLACCIATI WOOD
 WOOD VENEERED BACK PANELS

N.B.: inserire l'alimentatore corretto in base
all'assorbimento totale dato dalla somma degli elementi
inseriti nella composizione.
Vedi pagina 31

Note: insert the correct power supply in the base
to the total absorption given by the sum of the elements
included in the composition.
See page 31

TIPO E1

L 60 W21 Totali

H 101 top sp.4
 H 102 top sp.3
 H 102,6 top sp.2,4
 H 103 top sp.2
 H 103,8 top sp.1,2

L 65 W24 Totali

H 101 top sp.4
 H 102 top sp.3
 H 102,6 top sp.2,4
 H 103 top sp.2
 H 103,8 top sp.1,2

L 90 W30 Totali

H 101 top sp.4
 H 102 top sp.3
 H 102,6 top sp.2,4
 H 103 top sp.2
 H 103,8 top sp.1,2

L 120 W42 Totali

H 101 top sp.4
 H 102 top sp.3
 H 102,6 top sp.2,4
 H 103 top sp.2
 H 103,8 top sp.1,2

TIPO E2

L 60 W21 Totali

H 104 top sp.4
 H 105 top sp.3
 H 105,6 top sp.2,4
 H 106 top sp.2
 H 106,8 top sp.1,2

L 65 W24 Totali

H 104 top sp.4
 H 105 top sp.3
 H 105,6 top sp.2,4
 H 106 top sp.2
 H 106,8 top sp.1,2

L 90 W30 Totali

H 104 top sp.4
 H 105 top sp.3
 H 105,6 top sp.2,4
 H 106 top sp.2
 H 106,8 top sp.1,2

L 120 W42 Totali

H 104 top sp.4
 H 105 top sp.3
 H 105,6 top sp.2,4
 H 106 top sp.2
 H 106,8 top sp.1,2

TYPE E1

L 60 W21 Total

H 101 worktop th.4
 H 102 worktop th.3
 H 102,6 worktop th.2,4
 H 103 worktop th.2
 H 103,8 worktop th.1,2

L 65 W24 Total

H 101 worktop th.4
 H 102 worktop th.3
 H 102,6 worktop th.2,4
 H 103 worktop th.2
 H 103,8 worktop th.1,2

L 90 W30 Total

H 101 worktop th.4
 H 102 worktop th.3
 H 102,6 worktop th.2,4
 H 103 worktop th.2
 H 103,8 worktop th.1,2

L 120 W42 Total

H 101 worktop th.4
 H 102 worktop th.3
 H 102,6 worktop th.2,4
 H 103 worktop th.2
 H 103,8 worktop th.1,2

TYPE E2

L 60 W21 Total

H 104 worktop th.4
 H 105 worktop th.3
 H 105,6 worktop th.2,4
 H 106 worktop th.2
 H 106,8 worktop th.1,2

L 65 W24 Total

H 104 worktop th.4
 H 105 worktop th.3
 H 105,6 worktop th.2,4
 H 106 worktop th.2
 H 106,8 worktop th.1,2

L 90 W30 Total

H 104 worktop th.4
 H 105 worktop th.3
 H 105,6 worktop th.2,4
 H 106 worktop th.2
 H 106,8 worktop th.1,2

L 120 W42 Total

H 104 worktop th.4
 H 105 worktop th.3
 H 105,6 worktop th.2,4
 H 106 worktop th.2
 H 106,8 worktop th.1,2

CODICE
CODE No.

ACCIAIO
 STEEL

TITANIO
 TITANIUM

BRUNITO
 BURNISHED

086MDL3160
086MDL3360
086MDL3560
086MDL3760
086MDL3960

086MDL3165
086MDL3365
086MDL3565
086MDL3765
086MDL3965

086MDL3190
086MDL3390
086MDL3590
086MDL3790
086MDL3990

086MDL3195
086MDL3395
086MDL3595
086MDL3795
086MDL3995

086MDL4160
086MDL4360
086MDL4560
086MDL4760
086MDL4960

086MDL4165
086MDL4365
086MDL4565
086MDL4765
086MDL4965

086MDL4190
086MDL4390
086MDL4590
086MDL4790
086MDL4990

086MDL4195
086MDL4395
086MDL4595
086MDL4795
086MDL4995



MODULAR CON SCHIENALE E LUCE DUAL COLOR

MODULAR WITH BACK PANEL AND DUAL COLOR LIGHT

**Modulo cm 60-90 P 15,2
in appoggio con cielo e 3 ripiani.
N.B.: kit dual color incluso**

Lean on rack element
cm 60-90 D 15,2
with top panel and 3 shelves.
Note: kit dual colours
included

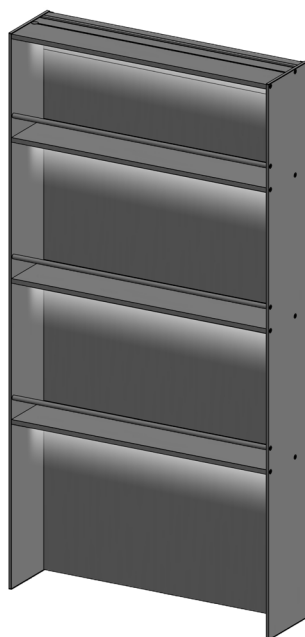

TIPO F1

L 60 W28 Totali
H 125 top sp.4
H 126 top sp.3
H 126,6 top sp.2,4
H 127 top sp.2
H 127,8 top sp.1,2

L 65 W32 Totali
H 125 top sp.4
H 126 top sp.3
H 126,6 top sp.2,4
H 127 top sp.2
H 127,8 top sp.1,2

L 90 W40 Totali
H 125 top sp.4
H 126 top sp.3
H 126,6 top sp.2,4
H 127 top sp.2
H 127,8 top sp.1,2

TYPE F1

L 60 W28 Total
H 125 worktop th.4
H 126 worktop th.3
H 126,6 worktop th.2,4
H 127 worktop th.2
H 127,8 worktop th.1,2

L 65 W32 Total
H 125 worktop th.4
H 126 worktop th.3
H 126,6 worktop th.2,4
H 127 worktop th.2
H 127,8 worktop th.1,2

L 90 W40 Total
H 125 worktop th.4
H 126 worktop th.3
H 126,6 worktop th.2,4
H 127 worktop th.2
H 127,8 worktop th.1,2

**CODICE
CODE No.**

ACCIAIO
STEEL

TITANIO
TITANIUM

BRUNITO
BURNISHED

**086MCL7160
086MCL7360
086MCL7560
086MCL7760
086MCL7960**

**086MCL7165
086MCL7365
086MCL7565
086MCL7765
086MCL7965**

**086MCL7190
086MCL7390
086MCL7590
086MCL7790
086MCL7990**

TIPO F2

L 60 W28 Totali
H 128 top sp.4
H 129 top sp.3
H 129,6 top sp.2,4
H 130 top sp.2
H 130,8 top sp.1,2

L 65 W32 Totali
H 128 top sp.4
H 129 top sp.3
H 129,6 top sp.2,4
H 130 top sp.2
H 130,8 top sp.1,2

L 90 W40 Totali
H 128 top sp.4
H 129 top sp.3
H 129,6 top sp.2,4
H 130 top sp.2
H 130,8 top sp.1,2

TYPE F2

L 60 W28 Total
H 128 worktop th.4
H 129 worktop th.3
H 129,6 worktop th.2,4
H 130 worktop th.2
H 130,8 worktop th.1,2

L 65 W32 Total
H 128 worktop th.4
H 129 worktop th.3
H 129,6 worktop th.2,4
H 130 worktop th.2
H 130,8 worktop th.1,2

L 90 W40 Total
H 128 worktop th.4
H 129 worktop th.3
H 129,6 worktop th.2,4
H 130 worktop th.2
H 130,8 worktop th.1,2

**086MCL8160
086MCL8360
086MCL8560
086MCL8760
086MCL8960**

**086MCL8165
086MCL8365
086MCL8565
086MCL8765
086MCL8965**

**086MCL8190
086MCL8390
086MCL8590
086MCL8790
086MCL8990**

SCHIENALI FENIX

FENIX BACK PANELS

SCHIENALI EFFETTO MARMO

EFFECT MARBLE BACK PANELS

SCHIENALI IMPIALLACCIATI WOOD

WOOD VENEERED BACK PANELS

**N.B.: inserire l'alimentatore corretto in base
all'assorbimento totale dato dalla somma degli elementi
inseriti nella composizione.
Vedi pagina 31**

**Note: insert the correct power supply in the base
to the total absorption given by the sum of the elements
included in the composition.
See page 31**

Finiture "MODULAR"

"MODULAR" finishes



Acciaio (opz.A)
Stainless Steel



Titanio (opz.T)
Titanium



Brunito (opz.B)
Burnished

MODULAR CON SCHIENALE E LUCE DUAL COLOR

MODULAR WITH BACK PANEL AND DUAL COLOR LIGHT

Modulo H 132 P 15,2
sospeso con cielo e 4 ripiani.
N.B.: kit dual color incluso

Hanging rack element
 H 132 D 15,2
 with top panel and 4 shelves.
 Note: kit dual colours
 included

CODICE
CODE No.

ACCIAIO
 STEEL

TITANIO
 TITANIUM

BRUNITO
 BURNISHED

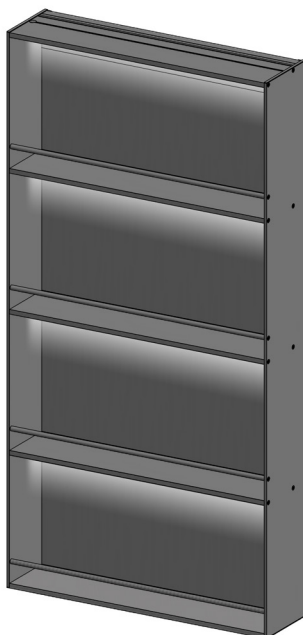

SCHIENALI FENIX
 FENIX BACK PANELS

SCHIENALI EFFETTO MARMO
 EFFECT MARBLE BACK PANELS

SCHIENALI IMPIALLACCIATI WOOD
 WOOD VENEERED BACK PANELS

N.B.: inserire l'alimentatore corretto in base
 all'assorbimento totale dato dalla somma degli elementi
 inseriti nella composizione.
 Vedi pagina 31

Note: insert the correct power supply in the base
 to the total absorption given by the sum of the elements
 included in the composition.
 See page 31

L 60 W28 Totali
L 90 W40 Totali

W 60 W28 Total
 W 90 W40 Total

086MDL9060
086MDL9090

Finiture "MODULAR"

"MODULAR" finishes



Acciaio (opz.A)
 Stainless Steel



Titanio (opz.T)
 Titanium



Brunito (opz.B)
 Burnished

DIMMER CON RADIOCOMANDO 4 ZONE

DIMMER WITH WIRELESS 4-ZONE CONTROL



RICEVITORE DIMMER

Dimensioni 145 x 46,5 x 16 mm

Questo ricevitore 24Vdc deve essere collegato al trasformatore e comanda fino a 6 barre LED fino a max 180 Watt di assorbimento. Fare riferimento ai Watt dei LED indicati in tabella.

DIMMER RECEIVER

Dimensions 145 x 46,5 x 16 mm

This 24Vdc device has to be connected to the power supply and can control up to 6 LED lights for a max power consumption of 180 Watt. Please refer to the Watt of each LED light in the table.

RADIOCOMANDO WIRELESS 4-ZONE (da abbinare a ricevitore dimmer)

Dimensioni 137 x 39 x 11 mm

Con questo radiocomando si possono comandare fino a 4 ricevitori insieme o in modo separato per creare 4 zone di illuminazione. Consente di accendere, spegnere e regolare la luminosità di ogni zona singolarmente o in una unica soluzione.

WIRELESS 4-ZONE CONTROL (to be paired to dimmer receiver)

Dimensions 137 x 39 x 11 mm

This wireless radiocontrol can be paired to max 4 dimmer receivers, thus creating 4 lighting areas. It allows to turn on, off and adjust the light intensity of each area distinctly or all together.

ALIMENTATORI POWER SUPPLIES



CODICE ITEM CODE	DESCRIZIONE DESCRIPTION
08616190A	TRASFORMATORE 220-24V 20W 3 USCITE
08616191	TRASFORMATORE 220-24V 30W 6 USCITE
08616192A	TRASFORMATORE 220-24V 50W 6 USCITE
08616195	TRASFORMATORE 220-24V 75W 6 USCITE
08616201	TRASFORMATORE 220-24V 100W 6 USCITE
08616202	TRASFORMATORE 220-24V 150W 6 USCITE

ALIMENTATORI POWER SUPPLIES

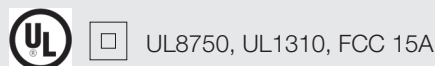

U.S. and CANADA



CODICE ITEM CODE	DESCRIZIONE DESCRIPTION
08616198	TRASFORMATORE 110-24V 30W 6 USCITE
08616200	TRASFORMATORE 110-24V 75W 6 USCITE

MODULAR ACCESSORI

ACCESSORIES MODULAR

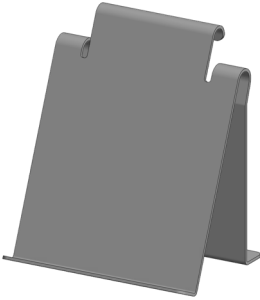
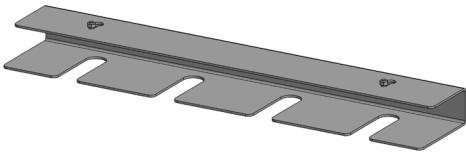
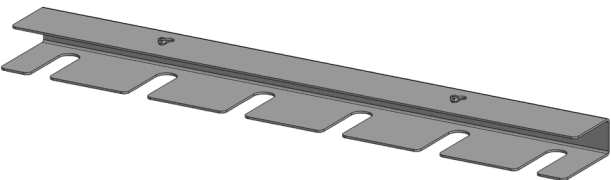
Reggi tablet		Tablet holder	CODICE CODE No.	ACCIAIO STEEL	TITANIO TITANIUM	BRUNITO BURNISHED
						
L 14 P 10,7 H 16,3		W 14 D 10,7 H 16,3	086M02			
Porta calici da 4		Stem rack (for 4 pcs)				
						
L 43 P 8 H 3,5		W 43 D 8 H 3,5	086M03			
Porta calici da 6		Stem rack (for 6 pcs)				
						
L 58 P 8 H 3,5		W 58 D 8 H 3,5	086M04			

MODULAR ACCESSORI

ACCESSORIES MODULAR

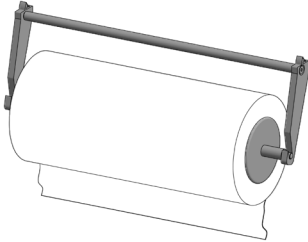
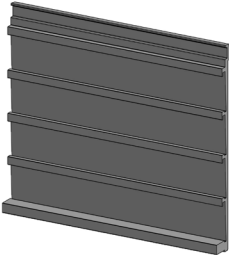
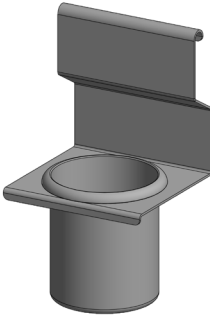
<p>Porta rotolo Roll holder</p>  <p>L 24 P 9 H 9,5 W 24 D 9 H 9,5</p>	<p>CODICE <i>CODE No.</i></p> <p>086M05</p>	<p>ACCIAIO STEEL</p>	<p>TITANIO TITANIUM</p>	<p>BRUNITO BURNISHED</p>
<p>Porta capsule caffè Coffee pod holder</p>  <p>L 22 P 3,1 H 19,5 W 22 D 3,1 H 19,5</p>	<p>086M06</p>			
<p>Porta contenitore alluminio/inox Aluminium/stainless steel can holder</p>  <p>L 14 P 12,9 H 25 W 14 D 12,9 H 25</p>	<p>086M07</p>			

MODULAR ACCESSORI

ACCESSORIES MODULAR

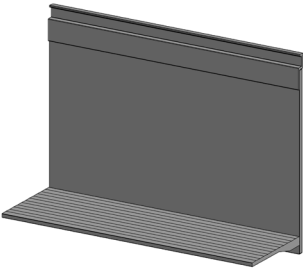
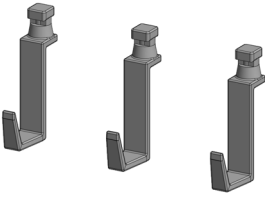
<p>Mensola vetro/alluminio</p> <p>Glass/Aluminium shelf</p>  <p>L 27 P 10,6 H 20,2</p>	<p>CODICE CODE No.</p> <p>086M08</p>	<p>ACCIAIO STEEL</p>	<p>TITANIO TITANIUM</p>	<p>BRUNITO BURNISHED</p>
<p>Set ganci</p> <p>Hooks kit</p>  <p>W 27 D 10,6 H 20,2</p>	<p>086M01</p>			

MODULAR ISOLA

MODULAR ISLAND

Modulo isola

Island hanging rack element

CODICE
CODE No.

ACCIAIO
STEEL

TITANIO
TITANIUM

BRUNITO
BURNISHED

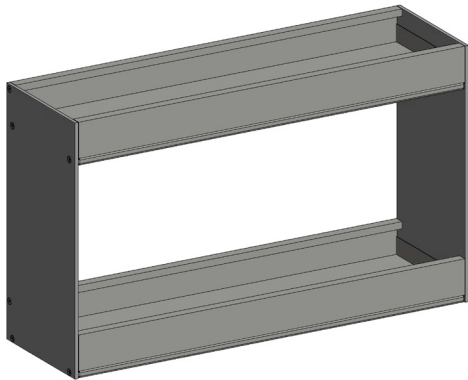

N.B.: vaschette non incluse
Note: bowls not included

L 60 P 18 H 36
L 90 P 18 H 36

W 60 D 18 H 36
W 90 D 18 H 36

08653000
08653005



Finiture "MODULAR"

"MODULAR" finishes



Acciaio (opz.A)
Stainless Steel

Titanio (opz.T)
Titanium

Brunito (opz.B)
Burnished

MODULAR ACCESSORI

ACCESSORIES MODULAR

Vaschetta

Bowl

CODICE
CODE No.

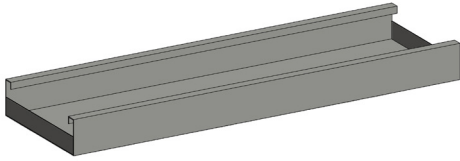

Finiture

Finishes



Acciaio (opz.A)
Stainless Steel

Titanio (opz.T)
Titanium

Brunito (opz.B)
Burnished



Rame (opz.R)
Copper

Grafite (opz.P)
Graphite

Bronzo Anticato (opz.Z)
Antique Bronze

L 58,9 P 18 H 5
W 58,9 D 18 H 5

Acciaio Stainless Steel
Titanio Titanium
Brunito Burnished
Rame Copper
Grafite Graphite
Bronzo Anticato Antique Bronze

08653015A
08653015T
08653015B
08653015R
08653015P
08653015Z

L 88,9 P 18 H 5
W 88,9 D 18 H 5

Acciaio Stainless Steel
Titanio Titanium
Brunito Burnished
Rame Copper
Grafite Graphite
Bronzo Anticato Antique Bronze

08653020A
08653020T
08653020B
08653020R
08653020P
08653020Z

CUCINE
LUBE

GRUPPO LUBE

CREO
KITCHENS

Air



Air è un sistema di profili estrusi in alluminio che attraverso tre diversi modi di giunzione consentono di ottenere numerose tipologie di strutture per mobili ed espositori.

I profili consentono il montaggio di piani in legno, vetro o altri materiali.

Air is a system of extruded aluminum profiles which, through three different joining methods, allow to obtain numerous types of structures for furniture and displays.

The profiles allow to assembly shelves made of wood, glass or other materials.











La struttura può essere tamponata posteriormente con diversi materiali per lasciare massima libertà di personalizzazione.

Le sue composizioni standard sono pensate per poter essere inserite nelle zone kitchen e living.

Air è un sistema di grande affidabilità strutturale e valore estetico, ideale per la casa, per gli ambienti operativi o espositivi, e dovunque serva praticità e rapidità d'arredo.

The structure can be padded on the back with different materials, to have the maximum freedom of customization.

Its standard compositions are designed for the kitchen and living areas.

Air is a system of great structural reliability and aesthetic value, ideal for the home, for operational or exhibition environments, and wherever practical and quick furnishing is required.

Pensili con schienale in lamiera e ripiani vetro

Wall units with sheet metal back panel and metal and glass shelves

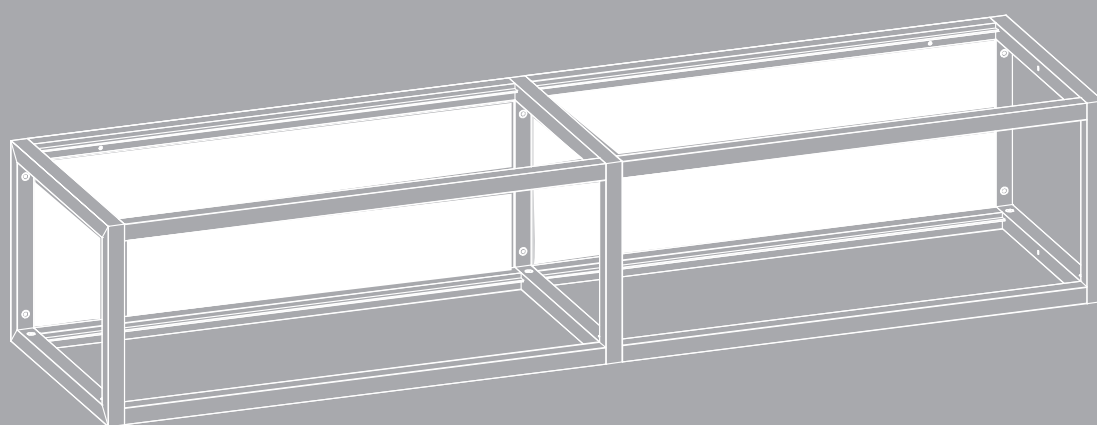

Pensili H 240

Wall Units

*A/V: A=ANODIZZATO V=VERNICIATO
ANODIZED PAINTED

CON SCHIENALE
WITH BACK PANEL

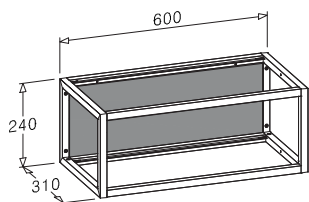

ALTEZZA, LARGHEZZA E PROFONDITA'
HEIGHT, WIDTH AND DEPTH
H.240 L.600 P.310 - H.240 W.600 D.310

CODICE ARTICOLO E7800060
ITEM NUMBER

FINITURA FINISH	A/V*	OPZIONE COLORE COLOUR OPTION
■ Nero Black	A	AL11
■ Titanio Titanium	A	AL12
■ Selce Flint Grey	V	AL13
■ Silver Dark Dark Silver	V	AL14
■ Oro Rosa Pink Gold	V	AL17
■ Rame Copper	V	AL23
■ Ottone Brass	V	AL24
■ Umber Umber	V	AL26

ALTEZZA, LARGHEZZA E PROFONDITA'
HEIGHT, WIDTH AND DEPTH
H.240 L.900 P.310 - H.240 W.900 D.310

CODICE ARTICOLO E7800090
ITEM NUMBER

FINITURA FINISH	A/V*	OPZIONE COLORE COLOUR OPTION
■ Nero Black	A	AL11
■ Titanio Titanium	A	AL12
■ Selce Flint Grey	V	AL13
■ Silver Dark Dark Silver	V	AL14
■ Oro Rosa Pink Gold	V	AL17
■ Rame Copper	V	AL23
■ Ottone Brass	V	AL24
■ Umber Umber	V	AL26

ALTEZZA, LARGHEZZA E PROFONDITA'
HEIGHT, WIDTH AND DEPTH
H.240 L.1200 P.310 - H.240 W.1200 D.310

CODICE ARTICOLO E7800120
ITEM NUMBER

FINITURA FINISH	A/V*	OPZIONE COLORE COLOUR OPTION
■ Nero Black	A	AL11
■ Titanio Titanium	A	AL12
■ Selce Flint Grey	V	AL13
■ Silver Dark Dark Silver	V	AL14
■ Oro Rosa Pink Gold	V	AL17
■ Rame Copper	V	AL23
■ Ottone Brass	V	AL24
■ Umber Umber	V	AL26

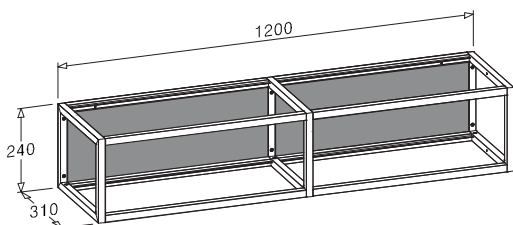
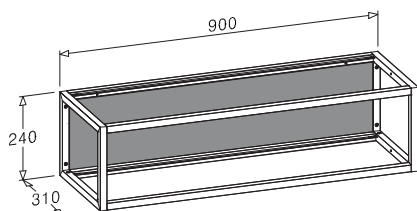

Pensili H 240

Wall Units

*A/V: A=ANODIZZATO V=VERNICIATO
ANODIZED PAINTED

CON SCHIENALE
WITH BACK PANEL

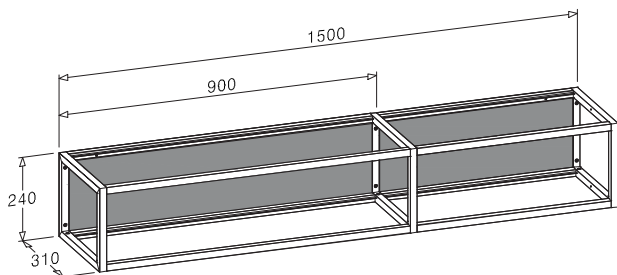

**VERSO DX
TO THE RIGHT**

ALTEZZA, LARGHEZZA E PROFONDITA'

HEIGHT, WIDTH AND DEPTH

H.240 L.1500 P.310 - H.240 W.1500 D.310

CODICE ARTICOLO E7800151

ITEM NUMBER

FINITURA FINISH	A/V*	OPZIONE COLORE COLOUR OPTION
■ Nero Black	A	AL11
■ Titanio Titanium	A	AL12
■ Selce Flint Grey	V	AL13
■ Silver Dark Dark Silver	V	AL14
■ Oro Rosa Pink Gold	V	AL17
■ Rame Copper	V	AL23
■ Ottone Brass	V	AL24
■ Umber Umber	V	AL26

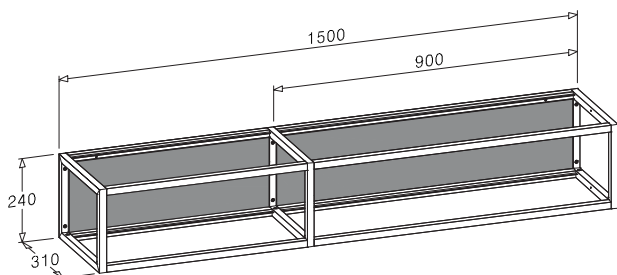

**VERSO SX
TO THE LEFT**

ALTEZZA, LARGHEZZA E PROFONDITA'

HEIGHT, WIDTH AND DEPTH

H.240 L.1500 P.310 - H.240 W.1500 D.310

CODICE ARTICOLO E7800152

ITEM NUMBER

FINITURA FINISH	A/V*	OPZIONE COLORE COLOUR OPTION
■ Nero Black	A	AL11
■ Titanio Titanium	A	AL12
■ Selce Flint Grey	V	AL13
■ Silver Dark Dark Silver	V	AL14
■ Oro Rosa Pink Gold	V	AL17
■ Rame Copper	V	AL23
■ Ottone Brass	V	AL24
■ Umber Umber	V	AL26

FINITURE PER RIPIANI VETRO

FINISHES FOR GLASS SHELVES

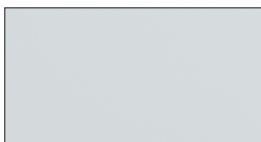

**VETRO TRASPARENTE
TRANSPARENT GLASS**



**VETRO FUME' TRASPARENTE
TRANSPARENT SMOKED GLASS**



**VETRO BRONZO TRASPARENTE
TRANSPARENT BRONZE GLASS**

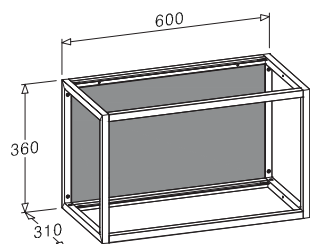

ALTEZZA, LARGHEZZA E PROFONDITA'
HEIGHT, WIDTH AND DEPTH
H.360 L.600 P.310 - H.360 W.600 D.310

CODICE ARTICOLO E7801060
ITEM NUMBER

FINITURA FINISH	A/V*	OPZIONE COLORE COLOUR OPTION
■ Nero Black	A	AL11
■ Titanio Titanium	A	AL12
■ Selce Flint Grey	V	AL13
■ Silver Dark Dark Silver	V	AL14
■ Oro Rosa Pink Gold	V	AL17
■ Rame Copper	V	AL23
■ Ottone Brass	V	AL24
■ Umber Umber	V	AL26

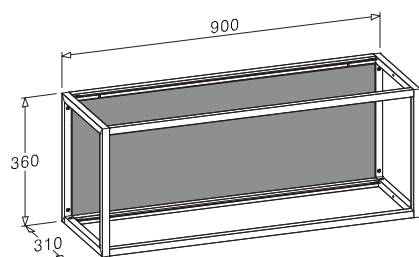

ALTEZZA, LARGHEZZA E PROFONDITA'
HEIGHT, WIDTH AND DEPTH
H.360 L.900 P.310 - H.360 W.900 D.310

CODICE ARTICOLO E7801090
ITEM NUMBER

FINITURA FINISH	A/V*	OPZIONE COLORE COLOUR OPTION
■ Nero Black	A	AL11
■ Titanio Titanium	A	AL12
■ Selce Flint Grey	V	AL13
■ Silver Dark Dark Silver	V	AL14
■ Oro Rosa Pink Gold	V	AL17
■ Rame Copper	V	AL23
■ Ottone Brass	V	AL24
■ Umber Umber	V	AL26

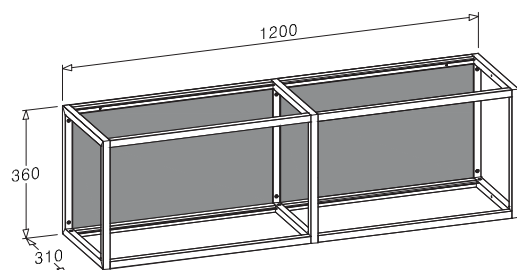

ALTEZZA, LARGHEZZA E PROFONDITA'
HEIGHT, WIDTH AND DEPTH
H.360 L.1200 P.310 - H.360 W.1200 D.310

CODICE ARTICOLO E7801120
ITEM NUMBER

FINITURA FINISH	A/V*	OPZIONE COLORE COLOUR OPTION
■ Nero Black	A	AL11
■ Titanio Titanium	A	AL12
■ Selce Flint Grey	V	AL13
■ Silver Dark Dark Silver	V	AL14
■ Oro Rosa Pink Gold	V	AL17
■ Rame Copper	V	AL23
■ Ottone Brass	V	AL24
■ Umber Umber	V	AL26

Pensili H 360

Wall Units

*A/V: A=ANODIZZATO V=VERNICIATO
ANODIZED PAINTED

CON SCHIENALE
WITH BACK PANEL

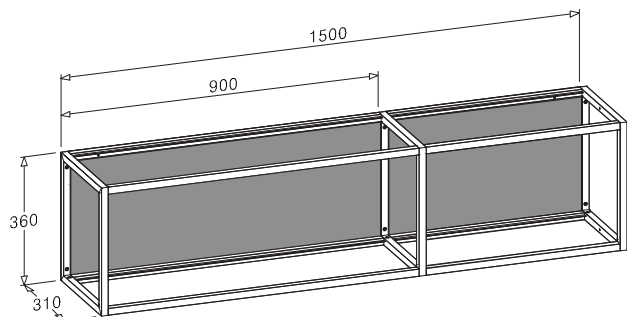

VERSO DX
TO THE RIGHT

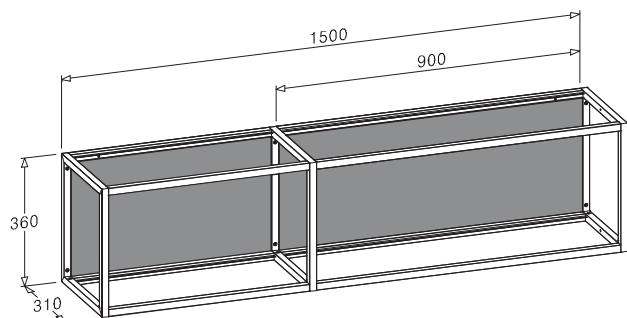

VERSO SX
TO THE LEFT

ALTEZZA, LARGHEZZA E PROFONDITA'
HEIGHT, WIDTH AND DEPTH
H.360 L.1500 P.310 - H.360 W.1500 D.310

CODICE ARTICOLO E7801151
ITEM NUMBER

FINITURA FINISH	A/V*	OPZIONE COLORE COLOUR OPTION
■ Nero Black	A	AL11
■ Titanio Titanium	A	AL12
■ Selce Flint Grey	V	AL13
■ Silver Dark Dark Silver	V	AL14
■ Oro Rosa Pink Gold	V	AL17
■ Rame Copper	V	AL23
■ Ottone Brass	V	AL24
■ Umber Umber	V	AL26

ALTEZZA, LARGHEZZA E PROFONDITA'
HEIGHT, WIDTH AND DEPTH
H.360 L.1500 P.310 - H.360 W.1500 D.310

CODICE ARTICOLO E7801152
ITEM NUMBER

FINITURA FINISH	A/V*	OPZIONE COLORE COLOUR OPTION
■ Nero Black	A	AL11
■ Titanio Titanium	A	AL12
■ Selce Flint Grey	V	AL13
■ Silver Dark Dark Silver	V	AL14
■ Oro Rosa Pink Gold	V	AL17
■ Rame Copper	V	AL23
■ Ottone Brass	V	AL24
■ Umber Umber	V	AL26

FINITURE PER RIPIANI VETRO

FINISHES FOR GLASS SHELVES

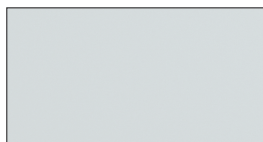

VETRO TRASPARENTE
TRANSPARENT GLASS



VETRO FUME' TRASPARENTE
TRANSPARENT SMOKED GLASS



VETRO BRONZO TRASPARENTE
TRANSPARENT BRONZE GLASS

Pensili H 480
Wall Units

***A/V: A=ANODIZZATO V=VERNICIATO**
ANODIZED PAINTED

CON SCHIENALE
WITH BACK PANEL

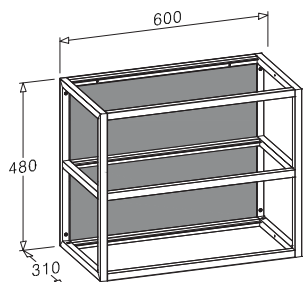

ALTEZZA, LARGHEZZA E PROFONDITA'
HEIGHT, WIDTH AND DEPTH
H.480 L.600 P.310 - H.480 W.600 D.310

CODICE ARTICOLO E7802060
ITEM NUMBER

FINITURA FINISH	A/V*	OPZIONE COLORE COLOUR OPTION
■ Nero Black	A	AL11
■ Titanio Titanium	A	AL12
■ Selce Flint Grey	V	AL13
■ Silver Dark Dark Silver	V	AL14
■ Oro Rosa Pink Gold	V	AL17
■ Rame Copper	V	AL23
■ Ottone Brass	V	AL24
■ Umber Umber	V	AL26

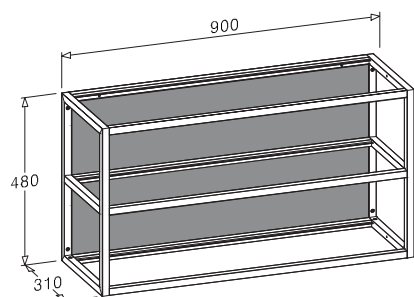

ALTEZZA, LARGHEZZA E PROFONDITA'
HEIGHT, WIDTH AND DEPTH
H.480 L.900 P.310 - H.480 W.900 D.310

CODICE ARTICOLO E7802090
ITEM NUMBER

FINITURA FINISH	A/V*	OPZIONE COLORE COLOUR OPTION
■ Nero Black	A	AL11
■ Titanio Titanium	A	AL12
■ Selce Flint Grey	V	AL13
■ Silver Dark Dark Silver	V	AL14
■ Oro Rosa Pink Gold	V	AL17
■ Rame Copper	V	AL23
■ Ottone Brass	V	AL24
■ Umber Umber	V	AL26

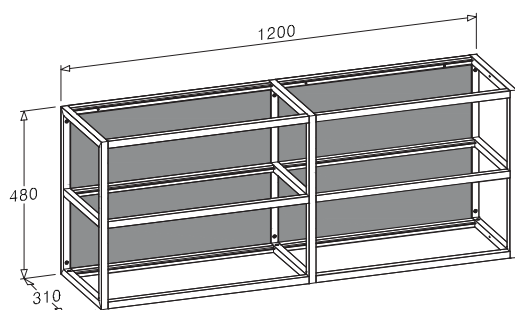

ALTEZZA, LARGHEZZA E PROFONDITA'
HEIGHT, WIDTH AND DEPTH
H.480 L.1200 P.310 - H.480 W.1200 D.310

CODICE ARTICOLO E7802120
ITEM NUMBER

FINITURA FINISH	A/V*	OPZIONE COLORE COLOUR OPTION
■ Nero Black	A	AL11
■ Titanio Titanium	A	AL12
■ Selce Flint Grey	V	AL13
■ Silver Dark Dark Silver	V	AL14
■ Oro Rosa Pink Gold	V	AL17
■ Rame Copper	V	AL23
■ Ottone Brass	V	AL24
■ Umber Umber	V	AL26

Pensili H 480

Wall Units

*A/V: A=ANODIZZATO V=VERNICIATO
ANODIZED PAINTED

CON SCHIENALE
WITH BACK PANEL

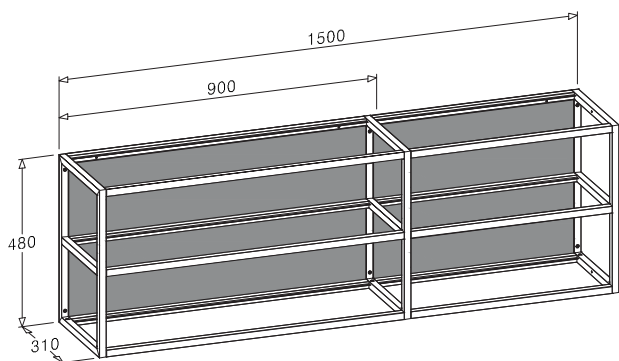

VERSO DX
TO THE RIGHT

ALTEZZA, LARGHEZZA E PROFONDITA'
HEIGHT, WIDTH AND DEPTH
H.480 L.1500 P.310 - H.480 W.1500 D.310

CODICE ARTICOLO E7802151
ITEM NUMBER

FINITURA FINISH	A/V*	OPZIONE COLORE COLOUR OPTION
■ Nero Black	A	AL11
■ Titanio Titanium	A	AL12
■ Selce Flint Grey	V	AL13
■ Silver Dark Dark Silver	V	AL14
■ Oro Rosa Pink Gold	V	AL17
■ Rame Copper	V	AL23
■ Ottone Brass	V	AL24
■ Umber Umber	V	AL26

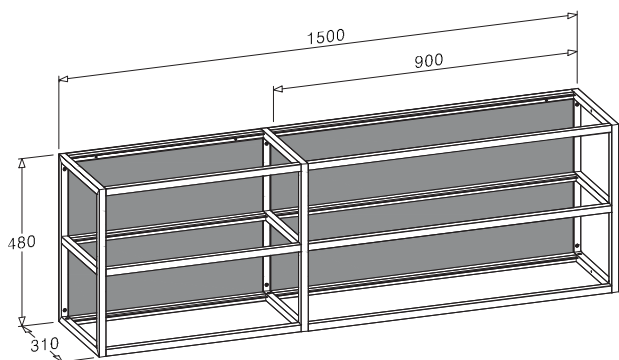

VERSO SX
TO THE LEFT

ALTEZZA, LARGHEZZA E PROFONDITA'
HEIGHT, WIDTH AND DEPTH
H.480 L.1500 P.310 - H.480 W.1500 D.310

CODICE ARTICOLO E7802152
ITEM NUMBER

FINITURA FINISH	A/V*	OPZIONE COLORE COLOUR OPTION
■ Nero Black	A	AL11
■ Titanio Titanium	A	AL12
■ Selce Flint Grey	V	AL13
■ Silver Dark Dark Silver	V	AL14
■ Oro Rosa Pink Gold	V	AL17
■ Rame Copper	V	AL23
■ Ottone Brass	V	AL24
■ Umber Umber	V	AL26

FINITURE PER RIPIANI VETRO

FINISHES FOR GLASS SHELVES

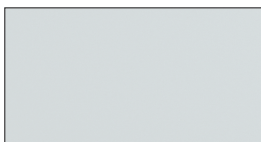

VETRO TRASPARENTE
TRANSPARENT GLASS



VETRO FUME' TRASPARENTE
TRANSPARENT SMOKED GLASS



VETRO BRONZO TRASPARENTE
TRANSPARENT BRONZE GLASS

Pensili H 600

Wall Units

*A/V: A=ANODIZZATO V=VERNICIATO
ANODIZED PAINTED

CON SCHIENALE
WITH BACK PANEL

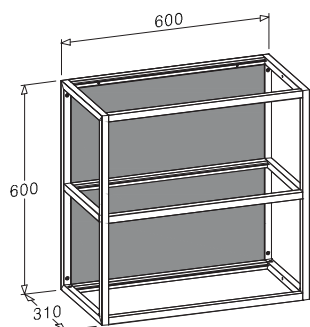

ALTEZZA, LARGHEZZA E PROFONDITA'
HEIGHT, WIDTH AND DEPTH
H.600 L.600 P.310 - H.600 W.600 D.310

CODICE ARTICOLO E7803060
ITEM NUMBER

FINITURA FINISH	A/V*	OPZIONE COLORE COLOUR OPTION
■ Nero Black	A	AL11
■ Titanio Titanium	A	AL12
■ Selce Flint Grey	V	AL13
■ Silver Dark Dark Silver	V	AL14
■ Oro Rosa Pink Gold	V	AL17
■ Rame Copper	V	AL23
■ Ottone Brass	V	AL24
■ Umber Umber	V	AL26

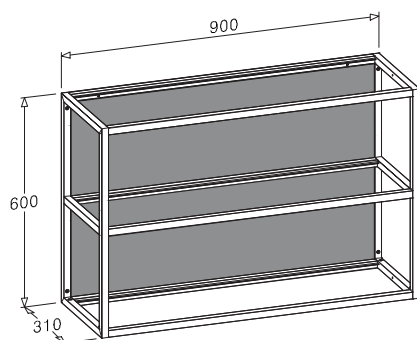

ALTEZZA, LARGHEZZA E PROFONDITA'
HEIGHT, WIDTH AND DEPTH
H.600 L.900 P.310 - H.600 W.900 D.310

CODICE ARTICOLO E7803090
ITEM NUMBER

FINITURA FINISH	A/V*	OPZIONE COLORE COLOUR OPTION
■ Nero Black	A	AL11
■ Titanio Titanium	A	AL12
■ Selce Flint Grey	V	AL13
■ Silver Dark Dark Silver	V	AL14
■ Oro Rosa Pink Gold	V	AL17
■ Rame Copper	V	AL23
■ Ottone Brass	V	AL24
■ Umber Umber	V	AL26

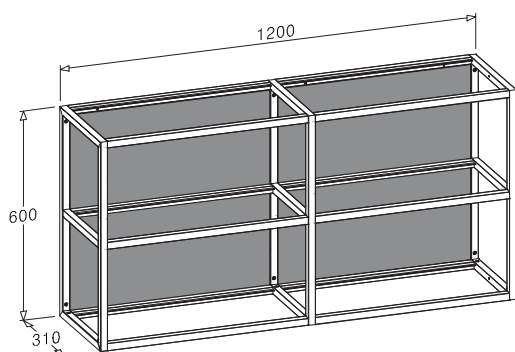

ALTEZZA, LARGHEZZA E PROFONDITA'
HEIGHT, WIDTH AND DEPTH
H.600 L.1200 P.310 - H.600 W.1200 D.310

CODICE ARTICOLO E7803120
ITEM NUMBER

FINITURA FINISH	A/V*	OPZIONE COLORE COLOUR OPTION
■ Nero Black	A	AL11
■ Titanio Titanium	A	AL12
■ Selce Flint Grey	V	AL13
■ Silver Dark Dark Silver	V	AL14
■ Oro Rosa Pink Gold	V	AL17
■ Rame Copper	V	AL23
■ Ottone Brass	V	AL24
■ Umber Umber	V	AL26

Pensili H 600
Wall Units

*A/V: A=ANODIZZATO V=VERNICIATO
ANODIZED PAINTED

CON SCHIENALE
WITH BACK PANEL

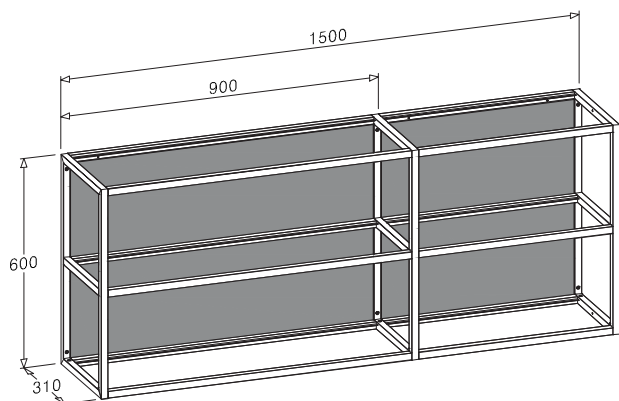

VERSO DX
TO THE RIGHT

ALTEZZA, LARGHEZZA E PROFONDITA'
HEIGHT, WIDTH AND DEPTH
H.600 L.1500 P.310 - H.600 W.1500 D.310

CODICE ARTICOLO E7803151
ITEM NUMBER

FINITURA FINISH	A/V*	OPZIONE COLORE COLOUR OPTION
■ Nero Black	A	AL11
■ Titanio Titanium	A	AL12
■ Selce Flint Grey	V	AL13
■ Silver Dark Dark Silver	V	AL14
■ Oro Rosa Pink Gold	V	AL17
■ Rame Copper	V	AL23
■ Ottone Brass	V	AL24
■ Umber Umber	V	AL26

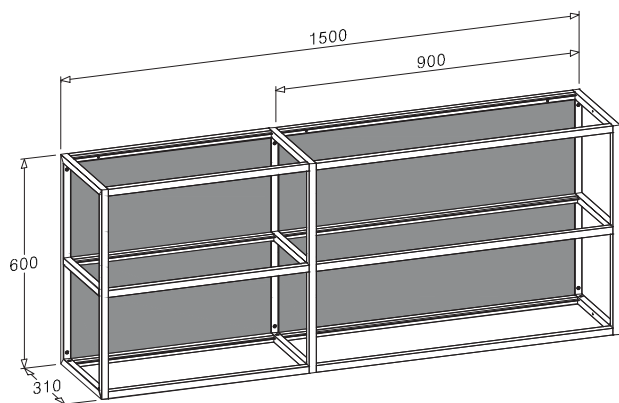

VERSO SX
TO THE LEFT

ALTEZZA, LARGHEZZA E PROFONDITA'
HEIGHT, WIDTH AND DEPTH
H.600 L.1500 P.310 - H.600 W.1500 D.310

CODICE ARTICOLO E7803152
ITEM NUMBER

FINITURA FINISH	A/V*	OPZIONE COLORE COLOUR OPTION
■ Nero Black	A	AL11
■ Titanio Titanium	A	AL12
■ Selce Flint Grey	V	AL13
■ Silver Dark Dark Silver	V	AL14
■ Oro Rosa Pink Gold	V	AL17
■ Rame Copper	V	AL23
■ Ottone Brass	V	AL24
■ Umber Umber	V	AL26

FINITURE PER RIPIANI VETRO
FINISHES FOR GLASS SHELVES

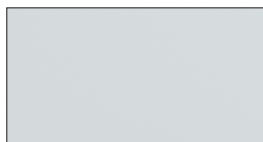

VETRO TRASPARENTE
TRANSPARENT GLASS



VETRO FUME' TRASPARENTE
TRANSPARENT SMOKED GLASS



VETRO BRONZO TRASPARENTE
TRANSPARENT BRONZE GLASS

Pensili con schiena personalizzata e ripiani vetro

Wall units with personalized back panel and glass shelves

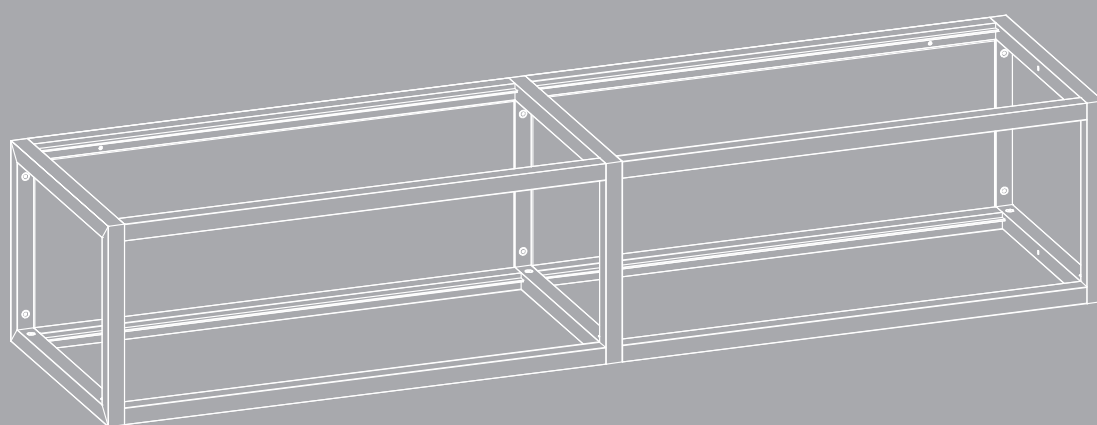

Pensili H 240

Wall Units

*A/V: A=ANODIZZATO V=VERNICIATO
ANODIZED PAINTED

N.B.: PER I COLORI DELLE SCHIENE VEDI PAG:74-77
NOTE: FOR THE BACK PANEL COLORS SEE PAGE 74-77

ALTEZZA, LARGHEZZA E PROFONDITA'

HEIGHT, WIDTH AND DEPTH

H.240 L.600 P.310 - H.240 W.600 D.310

CODICE ARTICOLO E7750060

ITEM NUMBER

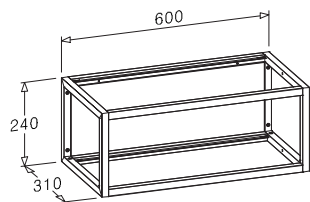

FINITURA FINISH	A/V*	OPZIONE COLORE COLOUR OPTION
■ Nero Black	A	AL11
■ Titanio Titanium	A	AL12
■ Selce Flint Grey	V	AL13
■ Silver Dark Dark Silver	V	AL14
■ Oro Rosa Pink Gold	V	AL17
■ Rame Copper	V	AL23
■ Ottone Brass	V	AL24
■ Umber Umber	V	AL26

ALTEZZA, LARGHEZZA E PROFONDITA'

HEIGHT, WIDTH AND DEPTH

H.240 L.900 P.310 - H.240 W.900 D.310

CODICE ARTICOLO E7750090

ITEM NUMBER

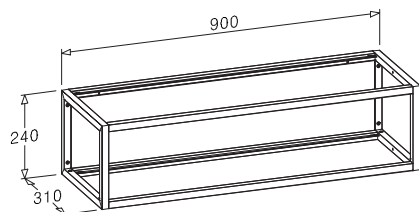

FINITURA FINISH	A/V*	OPZIONE COLORE COLOUR OPTION
■ Nero Black	A	AL11
■ Titanio Titanium	A	AL12
■ Selce Flint Grey	V	AL13
■ Silver Dark Dark Silver	V	AL14
■ Oro Rosa Pink Gold	V	AL17
■ Rame Copper	V	AL23
■ Ottone Brass	V	AL24
■ Umber Umber	V	AL26

ALTEZZA, LARGHEZZA E PROFONDITA'

HEIGHT, WIDTH AND DEPTH

H.240 L.1200 P.310 - H.240 W.1200 D.310

CODICE ARTICOLO E7750120

ITEM NUMBER

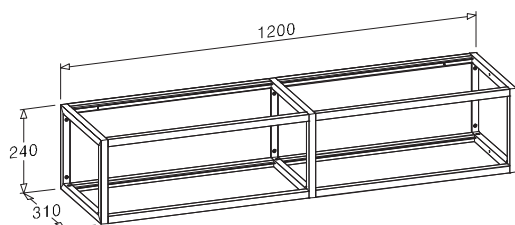

FINITURA FINISH	A/V*	OPZIONE COLORE COLOUR OPTION
■ Nero Black	A	AL11
■ Titanio Titanium	A	AL12
■ Selce Flint Grey	V	AL13
■ Silver Dark Dark Silver	V	AL14
■ Oro Rosa Pink Gold	V	AL17
■ Rame Copper	V	AL23
■ Ottone Brass	V	AL24
■ Umber Umber	V	AL26

Pensili H 240

Wall Units

*A/V: A=ANODIZZATO V=VERNICIATO
ANODIZED PAINTED

N.B.: PER I COLORI DELLE SCHIENE VEDI PAG:74-77
NOTE: FOR THE BACK PANEL COLORS SEE PAGE 74-77

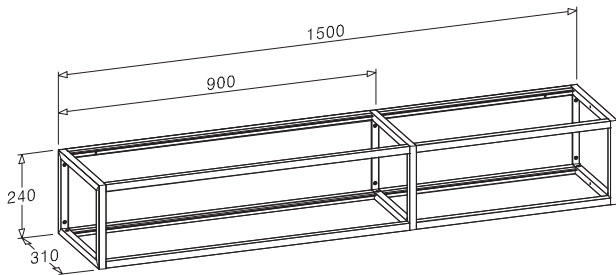

VERSO DX
TO THE RIGHT

ALTEZZA, LARGHEZZA E PROFONDITA'

HEIGHT, WIDTH AND DEPTH

H.240 L.1500 P.310 - H.240 W.1500 D.310

CODICE ARTICOLO E7750151
ITEM NUMBER

FINITURA FINISH	A/V*	OPZIONE COLORE COLOUR OPTION
■ Nero Black	A	AL11
■ Titanio Titanium	A	AL12
■ Selce Flint Grey	V	AL13
■ Silver Dark Dark Silver	V	AL14
■ Oro Rosa Pink Gold	V	AL17
■ Rame Copper	V	AL23
■ Ottone Brass	V	AL24
■ Umber Umber	V	AL26

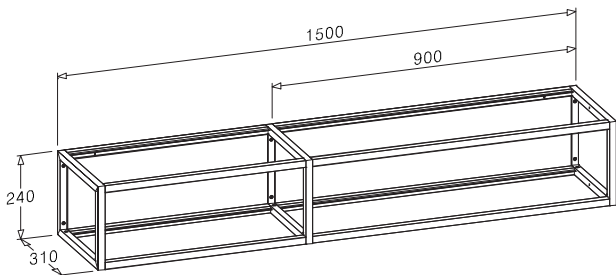

VERSO SX
TO THE LEFT

ALTEZZA, LARGHEZZA E PROFONDITA'

HEIGHT, WIDTH AND DEPTH

H.240 L.1500 P.310 - H.240 W.1500 D.310

CODICE ARTICOLO E7750152
ITEM NUMBER

FINITURA FINISH	A/V*	OPZIONE COLORE COLOUR OPTION
■ Nero Black	A	AL11
■ Titanio Titanium	A	AL12
■ Selce Flint Grey	V	AL13
■ Silver Dark Dark Silver	V	AL14
■ Oro Rosa Pink Gold	V	AL17
■ Rame Copper	V	AL23
■ Ottone Brass	V	AL24
■ Umber Umber	V	AL26

FINITURE PER RIPIANI VETRO

FINISHES FOR GLASS SHELVES

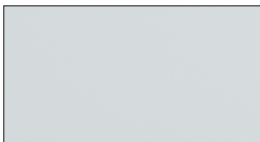

VETRO TRASPARENTE
TRANSPARENT GLASS



VETRO FUME' TRASPARENTE
TRANSPARENT SMOKED GLASS



VETRO BRONZO TRASPARENTE
TRANSPARENT BRONZE GLASS

Pensili H 360

Wall Units

*A/V: A=ANODIZZATO V=VERNICIATO
ANODIZED PAINTED

N.B.: PER I COLORI DELLE SCHIENE VEDI PAG:74-77
NOTE: FOR THE BACK PANEL COLORS SEE PAGE 74-77

ALTEZZA, LARGHEZZA E PROFONDITA'
HEIGHT, WIDTH AND DEPTH
H.360 L.600 P.310 - H.360 W.600 D.310

CODICE ARTICOLO E7751060
ITEM NUMBER

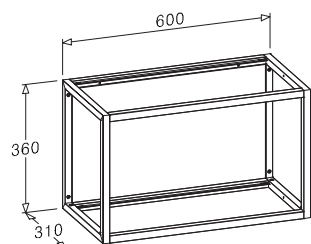

FINITURA FINISH	A/V*	OPZIONE COLORE COLOUR OPTION
■ Nero Black	A	AL11
■ Titanio Titanium	A	AL12
■ Selce Flint Grey	V	AL13
■ Silver Dark Dark Silver	V	AL14
■ Oro Rosa Pink Gold	V	AL17
■ Rame Copper	V	AL23
■ Ottone Brass	V	AL24
■ Umber Umber	V	AL26

ALTEZZA, LARGHEZZA E PROFONDITA'
HEIGHT, WIDTH AND DEPTH
H.360 L.900 P.310 - H.360 W.900 D.310

CODICE ARTICOLO E7751090
ITEM NUMBER

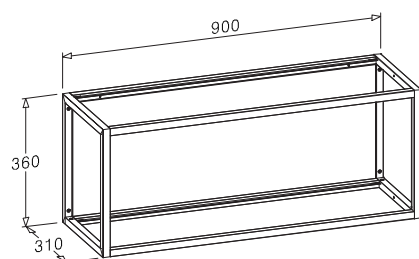

FINITURA FINISH	A/V*	OPZIONE COLORE COLOUR OPTION
■ Nero Black	A	AL11
■ Titanio Titanium	A	AL12
■ Selce Flint Grey	V	AL13
■ Silver Dark Dark Silver	V	AL14
■ Oro Rosa Pink Gold	V	AL17
■ Rame Copper	V	AL23
■ Ottone Brass	V	AL24
■ Umber Umber	V	AL26

ALTEZZA, LARGHEZZA E PROFONDITA'
HEIGHT, WIDTH AND DEPTH
H.360 L.1200 P.310 - H.360 W.1200 D.310

CODICE ARTICOLO E7751120
ITEM NUMBER

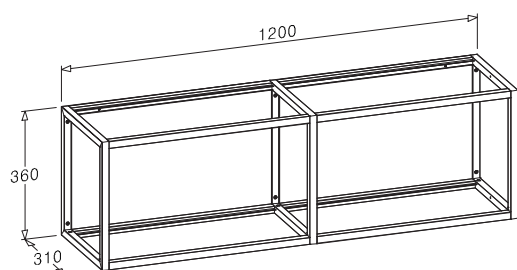

FINITURA FINISH	A/V*	OPZIONE COLORE COLOUR OPTION
■ Nero Black	A	AL11
■ Titanio Titanium	A	AL12
■ Selce Flint Grey	V	AL13
■ Silver Dark Dark Silver	V	AL14
■ Oro Rosa Pink Gold	V	AL17
■ Rame Copper	V	AL23
■ Ottone Brass	V	AL24
■ Umber Umber	V	AL26

Pensili H 360

Wall Units

*A/V: A=ANODIZZATO V=VERNICIATO
ANODIZED PAINTED

N.B.: PER I COLORI DELLE SCHIENE VEDI PAG:74-77
NOTE: FOR THE BACK PANEL COLORS SEE PAGE 74-77

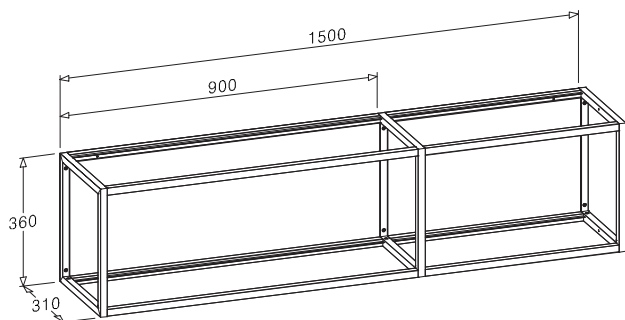

VERSO DX
TO THE RIGHT

ALTEZZA, LARGHEZZA E PROFONDITA'

HEIGHT, WIDTH AND DEPTH
H.360 L.1500 P.310 - H.360 W.1500 D.310

CODICE ARTICOLO E7751151
ITEM NUMBER

FINITURA FINISH	A/V*	OPZIONE COLORE COLOUR OPTION
■ Nero Black	A	AL11
■ Titanio Titanium	A	AL12
■ Selce Flint Grey	V	AL13
■ Silver Dark Dark Silver	V	AL14
■ Oro Rosa Pink Gold	V	AL17
■ Rame Copper	V	AL23
■ Ottone Brass	V	AL24
■ Umber Umber	V	AL26

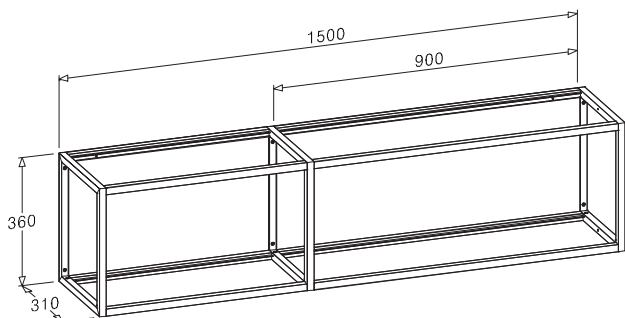

VERSO SX
TO THE LEFT

ALTEZZA, LARGHEZZA E PROFONDITA'

HEIGHT, WIDTH AND DEPTH
H.360 L.1500 P.310 - H.360 W.1500 D.310

CODICE ARTICOLO E7751152
ITEM NUMBER

FINITURA FINISH	A/V*	OPZIONE COLORE COLOUR OPTION
■ Nero Black	A	AL11
■ Titanio Titanium	A	AL12
■ Selce Flint Grey	V	AL13
■ Silver Dark Dark Silver	V	AL14
■ Oro Rosa Pink Gold	V	AL17
■ Rame Copper	V	AL23
■ Ottone Brass	V	AL24
■ Umber Umber	V	AL26

FINITURE PER RIPIANI VETRO

FINISHES FOR GLASS SHELVES

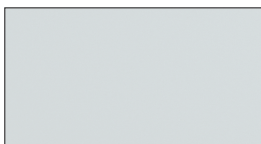

VETRO TRASPARENTE
TRANSPARENT GLASS



VETRO FUME' TRASPARENTE
TRANSPARENT SMOKED GLASS



VETRO BRONZO TRASPARENTE
TRANSPARENT BRONZE GLASS

Pensili H 480
Wall Units

*A/V: A=ANODIZZATO V=VERNICIATO
ANODIZED PAINTED

N.B.: PER I COLORI DELLE SCHIENE VEDI PAG:74-77
NOTE: FOR THE BACK PANEL COLORS SEE PAGE 74-77

ALTEZZA, LARGHEZZA E PROFONDITA'
HEIGHT, WIDTH AND DEPTH
H.480 L.600 P.310 - H.480 W.600 D.310

CODICE ARTICOLO E7752060
ITEM NUMBER

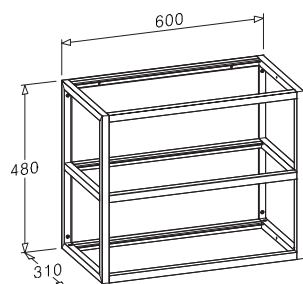

FINITURA FINISH	A/V*	OPZIONE COLORE COLOUR OPTION
■ Nero Black	A	AL11
■ Titanio Titanium	A	AL12
■ Selce Flint Grey	V	AL13
■ Silver Dark Dark Silver	V	AL14
■ Oro Rosa Pink Gold	V	AL17
■ Rame Copper	V	AL23
■ Ottone Brass	V	AL24
■ Umber Umber	V	AL26

ALTEZZA, LARGHEZZA E PROFONDITA'
HEIGHT, WIDTH AND DEPTH
H.480 L.900 P.310 - H.480 W.900 D.310

CODICE ARTICOLO E7752090
ITEM NUMBER

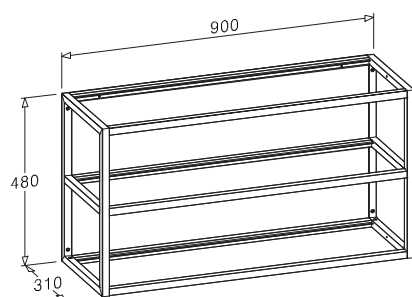

FINITURA FINISH	A/V*	OPZIONE COLORE COLOUR OPTION
■ Nero Black	A	AL11
■ Titanio Titanium	A	AL12
■ Selce Flint Grey	V	AL13
■ Silver Dark Dark Silver	V	AL14
■ Oro Rosa Pink Gold	V	AL17
■ Rame Copper	V	AL23
■ Ottone Brass	V	AL24
■ Umber Umber	V	AL26

ALTEZZA, LARGHEZZA E PROFONDITA'
HEIGHT, WIDTH AND DEPTH
H.480 L.1200 P.310 - H.480 W.1200 D.310

CODICE ARTICOLO E7752120
ITEM NUMBER

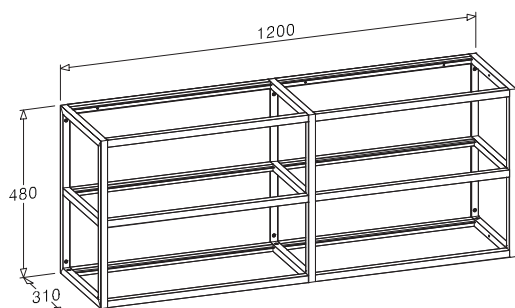

FINITURA FINISH	A/V*	OPZIONE COLORE COLOUR OPTION
■ Nero Black	A	AL11
■ Titanio Titanium	A	AL12
■ Selce Flint Grey	V	AL13
■ Silver Dark Dark Silver	V	AL14
■ Oro Rosa Pink Gold	V	AL17
■ Rame Copper	V	AL23
■ Ottone Brass	V	AL24
■ Umber Umber	V	AL26

Pensili H 480

Wall Units

*A/V: A=ANODIZZATO V=VERNICIATO
ANODIZED PAINTED

N.B.: PER I COLORI DELLE SCHIENE VEDI PAG:74-77
NOTE: FOR THE BACK PANEL COLORS SEE PAGE 74-77

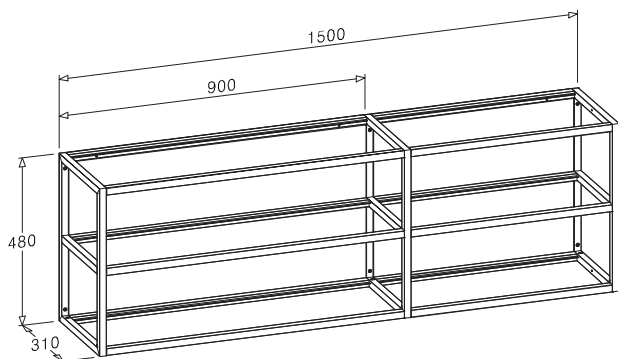

VERSO DX
TO THE RIGHT

ALTEZZA, LARGHEZZA E PROFONDITA'

HEIGHT, WIDTH AND DEPTH

H.480 L.1500 P.310 - H.480 W.1500 D.310

CODICE ARTICOLO E7752151

ITEM NUMBER

FINITURA FINISH	A/V*	OPZIONE COLORE COLOUR OPTION
Nero Black	A	AL11
Titanio Titanium	A	AL12
Selce Flint Grey	V	AL13
Silver Dark Dark Silver	V	AL14
Oro Rosa Pink Gold	V	AL17
Rame Copper	V	AL23
Ottone Brass	V	AL24
Umber Umber	V	AL26

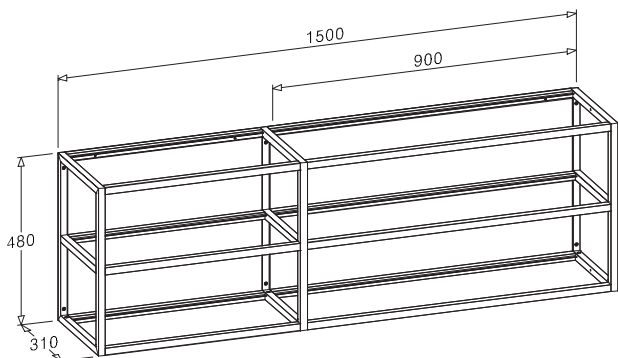

VERSO SX
TO THE LEFT

ALTEZZA, LARGHEZZA E PROFONDITA'

HEIGHT, WIDTH AND DEPTH

H.480 L.1500 P.310 - H.480 W.1500 D.310

CODICE ARTICOLO E7752152

ITEM NUMBER

FINITURA FINISH	A/V*	OPZIONE COLORE COLOUR OPTION
Nero Black	A	AL11
Titanio Titanium	A	AL12
Selce Flint Grey	V	AL13
Silver Dark Dark Silver	V	AL14
Oro Rosa Pink Gold	V	AL17
Rame Copper	V	AL23
Ottone Brass	V	AL24
Umber Umber	V	AL26

FINITURE PER RIPIANI VETRO

FINISHES FOR GLASS SHELVES

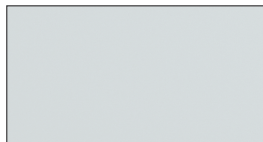

VETRO TRASPARENTE
TRANSPARENT GLASS



VETRO FUME' TRASPARENTE
TRANSPARENT SMOKED GLASS



VETRO BRONZO TRASPARENTE
TRANSPARENT BRONZE GLASS

Pensili H 600
Wall Units

*A/V: A=ANODIZZATO V=VERNICIATO
ANODIZED PAINTED

N.B.: PER I COLORI DELLE SCHIENE VEDI PAG:74-77
NOTE: FOR THE BACK PANEL COLORS SEE PAGE 74-77

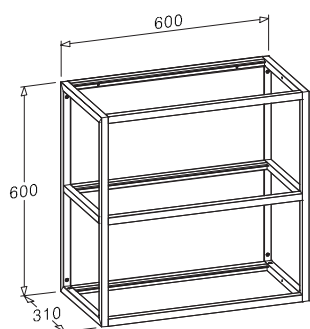

ALTEZZA, LARGHEZZA E PROFONDITA'
HEIGHT, WIDTH AND DEPTH
H.600 L.600 P.310 - H.600 W.600 D.310

CODICE ARTICOLO E7753060
ITEM NUMBER

FINITURA FINISH	A/V*	OPZIONE COLORE COLOUR OPTION
■ Nero Black	A	AL11
■ Titanio Titanium	A	AL12
■ Selce Flint Grey	V	AL13
■ Silver Dark Dark Silver	V	AL14
■ Oro Rosa Pink Gold	V	AL17
■ Rame Copper	V	AL23
■ Ottone Brass	V	AL24
■ Umber Umber	V	AL26

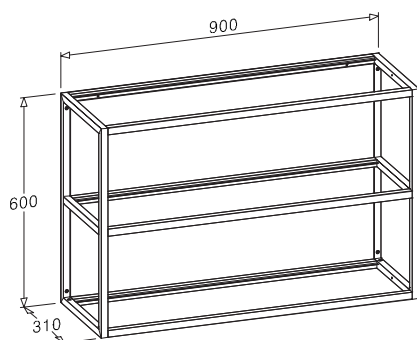

ALTEZZA, LARGHEZZA E PROFONDITA'
HEIGHT, WIDTH AND DEPTH
H.600 L.900 P.310 - H.600 W.900 D.310

CODICE ARTICOLO E7753090
ITEM NUMBER

FINITURA FINISH	A/V*	OPZIONE COLORE COLOUR OPTION
■ Nero Black	A	AL11
■ Titanio Titanium	A	AL12
■ Selce Flint Grey	V	AL13
■ Silver Dark Dark Silver	V	AL14
■ Oro Rosa Pink Gold	V	AL17
■ Rame Copper	V	AL23
■ Ottone Brass	V	AL24
■ Umber Umber	V	AL26

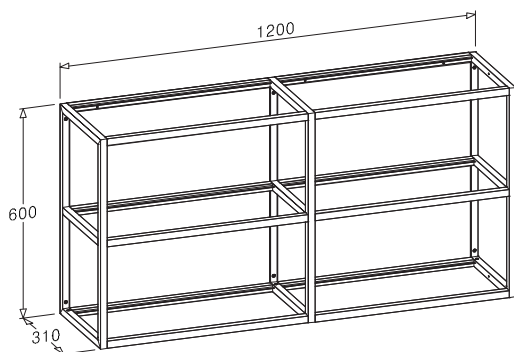

ALTEZZA, LARGHEZZA E PROFONDITA'
HEIGHT, WIDTH AND DEPTH
H.600 L.1200 P.310 - H.600 W.1200 D.310

CODICE ARTICOLO E7753120
ITEM NUMBER

FINITURA FINISH	A/V*	OPZIONE COLORE COLOUR OPTION
■ Nero Black	A	AL11
■ Titanio Titanium	A	AL12
■ Selce Flint Grey	V	AL13
■ Silver Dark Dark Silver	V	AL14
■ Oro Rosa Pink Gold	V	AL17
■ Rame Copper	V	AL23
■ Ottone Brass	V	AL24
■ Umber Umber	V	AL26

Pensili H 600

Wall Units

*A/V: A=ANODIZZATO V=VERNICIATO
ANODIZED PAINTED

N.B.: PER I COLORI DELLE SCHIENE VEDI PAG:74-77
NOTE: FOR THE BACK PANEL COLORS SEE PAGE 74-77

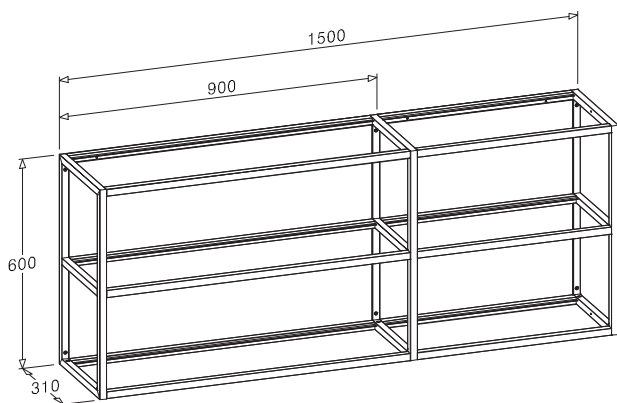

VERSO DX
TO THE RIGHT

ALTEZZA, LARGHEZZA E PROFONDITA'

HEIGHT, WIDTH AND DEPTH

H.600 L.1500 P.310 - H.600 W.1500 D.310

CODICE ARTICOLO E7753151

ITEM NUMBER

FINITURA FINISH	A/V*	OPZIONE COLORE COLOUR OPTION
Nero Black	A	AL11
Titanio Titanium	A	AL12
Selce Flint Grey	V	AL13
Silver Dark Dark Silver	V	AL14
Oro Rosa Pink Gold	V	AL17
Rame Copper	V	AL23
Ottone Brass	V	AL24
Umber Umber	V	AL26

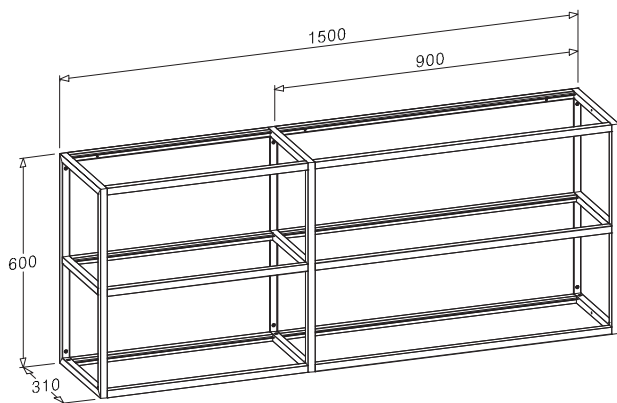

VERSO SX
TO THE LEFT

ALTEZZA, LARGHEZZA E PROFONDITA'

HEIGHT, WIDTH AND DEPTH

H.600 L.1500 P.310 - H.600 W.1500 D.310

CODICE ARTICOLO E7753152

ITEM NUMBER

FINITURA FINISH	A/V*	OPZIONE COLORE COLOUR OPTION
Nero Black	A	AL11
Titanio Titanium	A	AL12
Selce Flint Grey	V	AL13
Silver Dark Dark Silver	V	AL14
Oro Rosa Pink Gold	V	AL17
Rame Copper	V	AL23
Ottone Brass	V	AL24
Umber Umber	V	AL26

FINITURE PER RIPIANI VETRO

FINISHES FOR GLASS SHELVES

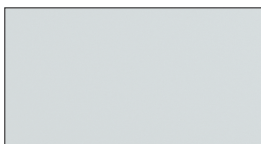

VETRO TRASPARENTE
TRANSPARENT GLASS



VETRO FUME' TRASPARENTE
TRANSPARENT SMOKED GLASS



VETRO BRONZO TRASPARENTE
TRANSPARENT BRONZE GLASS

Pensili alti con schienale in lamiera e ripiani vetro

Tall wall units with sheet metal back panel and glass shelves

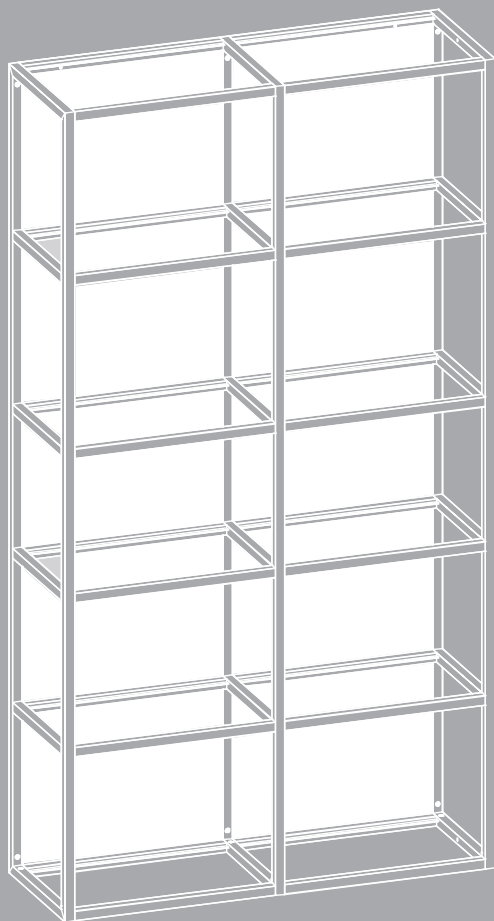

Pensili H 720

Wall Units

*A/V: A=ANODIZZATO V=VERNICIATO
ANODIZED PAINTED

CON SCHIENALE
WITH BACK PANEL

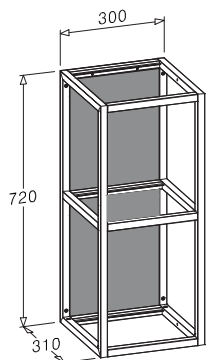

ALTEZZA, LARGHEZZA E PROFONDITA'

HEIGHT, WIDTH AND DEPTH
H.720 L.300 P.310 - H.720 W.300 D.310

CODICE ARTICOLO E7804030
ITEM NUMBER

FINITURA FINISH	A/V*	OPZIONE COLORE COLOUR OPTION
■ Nero Black	A	AL11
■ Titanio Titanium	A	AL12
■ Selce Flint Grey	V	AL13
■ Silver Dark Dark Silver	V	AL14
■ Oro Rosa Pink Gold	V	AL17
■ Rame Copper	V	AL23
■ Ottone Brass	V	AL24
■ Umber Umber	V	AL26

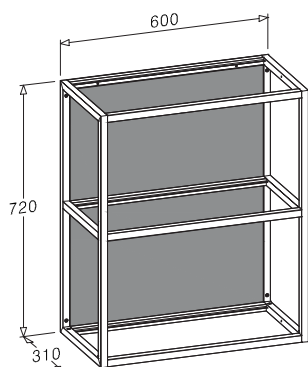

ALTEZZA, LARGHEZZA E PROFONDITA'

HEIGHT, WIDTH AND DEPTH
H.720 L.600 P.310 - H.720 W.600 D.310

CODICE ARTICOLO E7804060
ITEM NUMBER

FINITURA FINISH	A/V*	OPZIONE COLORE COLOUR OPTION
■ Nero Black	A	AL11
■ Titanio Titanium	A	AL12
■ Selce Flint Grey	V	AL13
■ Silver Dark Dark Silver	V	AL14
■ Oro Rosa Pink Gold	V	AL17
■ Rame Copper	V	AL23
■ Ottone Brass	V	AL24
■ Umber Umber	V	AL26

Pensili H 960

Wall Units

*A/V: A=ANODIZZATO V=VERNICIATO
ANODIZED PAINTED

CON SCHIENALE
WITH BACK PANEL

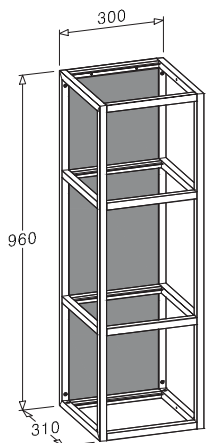

ALTEZZA, LARGHEZZA E PROFONDITA'

HEIGHT, WIDTH AND DEPTH

H.960 L.300 P.310 - H.960 W.300 D.310

CODICE ARTICOLO E7805030
ITEM NUMBER

FINITURA FINISH	A/V*	OPZIONE COLORE COLOUR OPTION
Nero Black	A	AL11
Titanio Titanium	A	AL12
Selce Flint Grey	V	AL13
Silver Dark Dark Silver	V	AL14
Oro Rosa Pink Gold	V	AL17
Rame Copper	V	AL23
Ottone Brass	V	AL24
Umber Umber	V	AL26

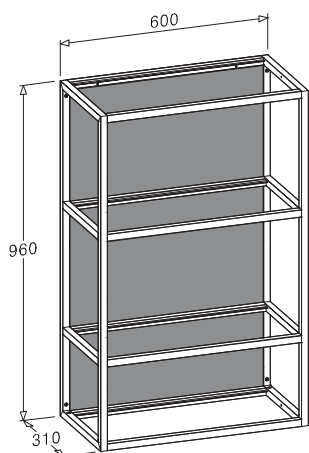

ALTEZZA, LARGHEZZA E PROFONDITA'

HEIGHT, WIDTH AND DEPTH

H.960 L.600 P.310 - H.960 W.600 D.310

CODICE ARTICOLO E7805060
ITEM NUMBER

FINITURA FINISH	A/V*	OPZIONE COLORE COLOUR OPTION
Nero Black	A	AL11
Titanio Titanium	A	AL12
Selce Flint Grey	V	AL13
Silver Dark Dark Silver	V	AL14
Oro Rosa Pink Gold	V	AL17
Rame Copper	V	AL23
Ottone Brass	V	AL24
Umber Umber	V	AL26

FINITURE PER RIPIANI VETRO

FINISHES FOR GLASS SHELVES

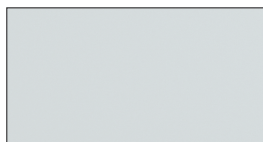

VETRO TRASPARENTE
TRANSPARENT GLASS



VETRO FUME' TRASPARENTE
TRANSPARENT SMOKED GLASS



VETRO BRONZO TRASPARENTE
TRANSPARENT BRONZE GLASS

Pensili H 1020

Wall Units

***A/V:** A=ANODIZZATO V=VERNICIATO
ANODIZED PAINTED

CON SCHIENALE
WITH BACK PANEL

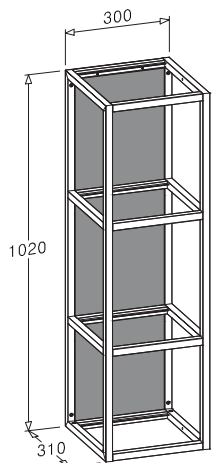

ALTEZZA, LARGHEZZA E PROFONDITA'
HEIGHT, WIDTH AND DEPTH
H.1020 L.300 P.310 - H.1020 W.300 D.310

CODICE ARTICOLO E7806030
ITEM NUMBER

FINITURA FINISH	A/V*	OPZIONE COLORE COLOUR OPTION
■ Nero Black	A	AL11
■ Titanio Titanium	A	AL12
■ Selce Flint Grey	V	AL13
■ Silver Dark Dark Silver	V	AL14
■ Oro Rosa Pink Gold	V	AL17
■ Rame Copper	V	AL23
■ Ottone Brass	V	AL24
■ Umber Umber	V	AL26

Pensili H 1320

Wall Units

*A/V: A=ANODIZZATO V=VERNICIATO
ANODIZED PAINTED

CON SCHIENALE
WITH BACK PANEL

ALTEZZA, LARGHEZZA E PROFONDITA'

HEIGHT, WIDTH AND DEPTH

H.1320 L.300 P.310 - H.1320 W.300 D.310

CODICE ARTICOLO E7806160

ITEM NUMBER

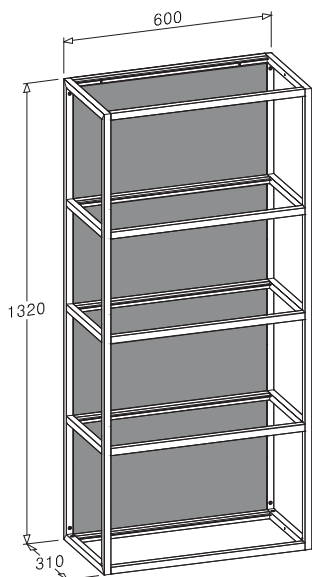

FINITURA FINISH	A/V*	OPZIONE COLORE COLOUR OPTION
■ Nero Black	A	AL11
■ Titanio Titanium	A	AL12
■ Selce Flint Grey	V	AL13
■ Silver Dark Dark Silver	V	AL14
■ Oro Rosa Pink Gold	V	AL17
■ Rame Copper	V	AL23
■ Ottone Brass	V	AL24
■ Umber Umber	V	AL26

FINITURE PER RIPIANI VETRO

FINISHES FOR GLASS SHELVES

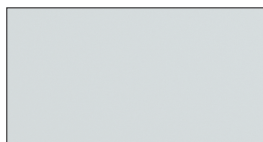

VETRO TRASPARENTE
TRANSPARENT GLASS



VETRO FUME' TRASPARENTE
TRANSPARENT SMOKED GLASS



VETRO BRONZO TRASPARENTE
TRANSPARENT BRONZE GLASS

Pensili H 1680
Wall Units

*A/V: A=ANODIZZATO V=VERNICIATO
ANODIZED PAINTED

CON SCHIENALE
WITH BACK PANEL

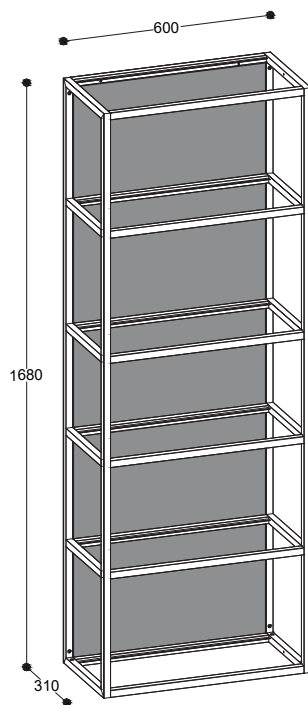
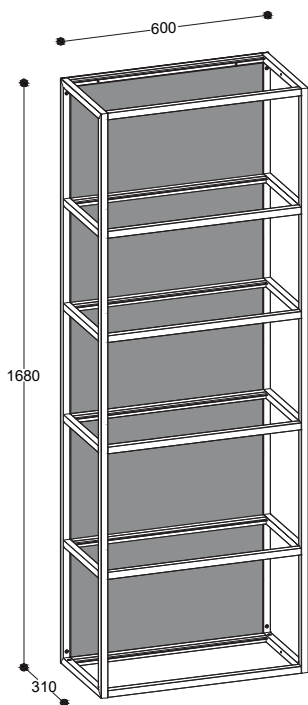

ALTEZZA, LARGHEZZA E PROFONDITA'
HEIGHT, WIDTH AND DEPTH
H.1680 L.600 P.310 - H.1680 W.600 D.310

CODICE ARTICOLO E7807060
ITEM NUMBER

FINITURA FINISH	A/V*	OPZIONE COLORE COLOUR OPTION
Nero Black	A	AL11
Titanio Titanium	A	AL12
Selce Flint Grey	V	AL13
Silver Dark Dark Silver	V	AL14
Oro Rosa Pink Gold	V	AL17
Rame Copper	V	AL23
Ottone Brass	V	AL24
Umber Umber	V	AL26

ALTEZZA, LARGHEZZA E PROFONDITA'
HEIGHT, WIDTH AND DEPTH
H.1680 L.600 P.310 - H.1680 W.600 D.310

RIALZATO RAISED
CODICE ARTICOLO E7807063
ITEM NUMBER

PER ALLINEAMENTO UTILIZZARE
MODULO H 36 (vedi pag.79-80)
FOR ALIGNMENT USE
MODULE H 36 (see page 79-80)

RIALZATO
PER ALLINEAMENTO UTILIZZARE
MODULO H 72 (vedi pag.79-80)
RAISED
FOR ALIGNMENT USE
MODULE H 72 (see page 79-80)

FINITURA FINISH	A/V*	OPZIONE COLORE COLOUR OPTION
Nero Black	A	AL11
Titanio Titanium	A	AL12
Selce Flint Grey	V	AL13
Silver Dark Dark Silver	V	AL14
Oro Rosa Pink Gold	V	AL17
Rame Copper	V	AL23
Ottone Brass	V	AL24
Umber Umber	V	AL26

ALTEZZA, LARGHEZZA E PROFONDITA'
HEIGHT, WIDTH AND DEPTH
H.1680 L.900 P.310 - H.1680 W.900 D.310

CODICE ARTICOLO E7807090
ITEM NUMBER

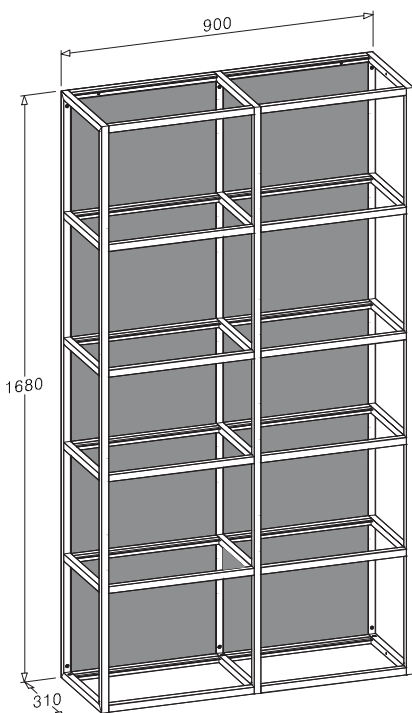

FINITURA FINISH	A/V*	OPZIONE COLORE COLOUR OPTION
Nero Black	A	AL11
Titanio Titanium	A	AL12
Selce Flint Grey	V	AL13
Silver Dark Dark Silver	V	AL14
Oro Rosa Pink Gold	V	AL17
Rame Copper	V	AL23
Ottone Brass	V	AL24
Umber Umber	V	AL26

Pensili H 2040

Wall Units

*A/V: A=ANODIZZATO V=VERNICIATO
ANODIZED PAINTED

CON SCHIENALE
WITH BACK PANEL

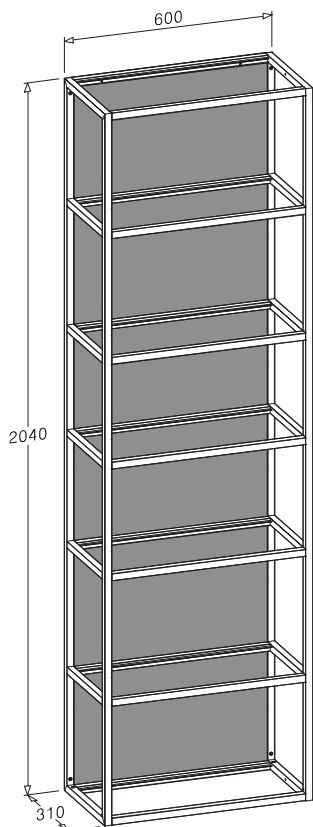

ALTEZZA, LARGHEZZA E PROFONDITA'

HEIGHT, WIDTH AND DEPTH

H.2040 L.600 P.310 - H.2040 W.600 D.310

CODICE ARTICOLO E7838060

ITEM NUMBER

FINITURA FINISH	A/V*	OPZIONE COLORE COLOUR OPTION
■ Nero Black	A	AL11
■ Titanio Titanium	A	AL12
■ Selce Flint Grey	V	AL13
■ Silver Dark Dark Silver	V	AL14
■ Oro Rosa Pink Gold	V	AL17
■ Rame Copper	V	AL23
■ Ottone Brass	V	AL24
■ Umber Umber	V	AL26

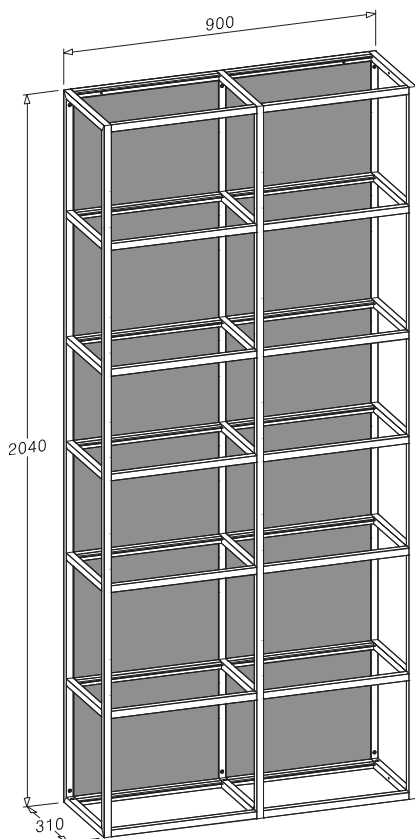

ALTEZZA, LARGHEZZA E PROFONDITA'

HEIGHT, WIDTH AND DEPTH

H.2040 L.900 P.310 - H.2040 W.900 D.310

CODICE ARTICOLO E7838090

ITEM NUMBER

FINITURA FINISH	A/V*	OPZIONE COLORE COLOUR OPTION
■ Nero Black	A	AL11
■ Titanio Titanium	A	AL12
■ Selce Flint Grey	V	AL13
■ Silver Dark Dark Silver	V	AL14
■ Oro Rosa Pink Gold	V	AL17
■ Rame Copper	V	AL23
■ Ottone Brass	V	AL24
■ Umber Umber	V	AL26

FINITURE PER RIPIANI VETRO

FINISHES FOR GLASS SHELVES

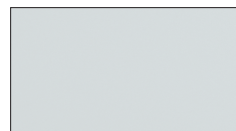

VETRO TRASPARENTE
TRANSPARENT GLASS



VETRO FUME' TRASPARENTE
TRANSPARENT SMOKED GLASS



VETRO BRONZO TRASPARENTE
TRANSPARENT BRONZE GLASS

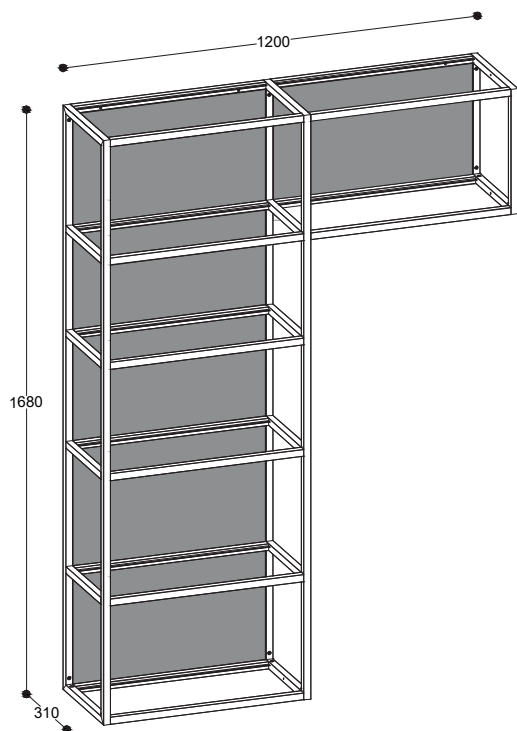

VERSO DX (esempio di utilizzo vedi pag.79-80)
TO THE RIGHT (example of use see page 79-80)

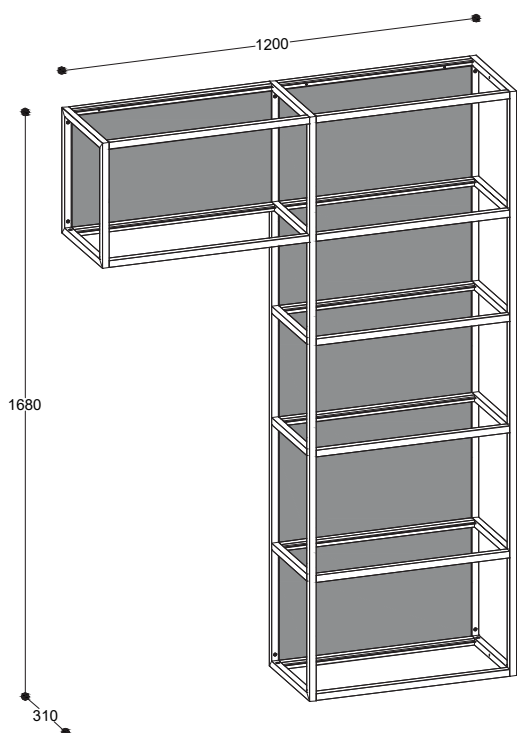

VERSO SX (esempio di utilizzo vedi pag.79-80)
TO THE LEFT (example of use see page 79-80)

ALTEZZA, LARGHEZZA E PROFONDITA'
HEIGHT, WIDTH AND DEPTH
H.1680 L.1200 P.310 - H.1680 W.1200 D.310

CODICE ARTICOLO E7807121
ITEM NUMBER

FINITURA FINISH	A/V*	OPZIONE COLORE COLOUR OPTION
■ Nero Black	A	AL11
■ Titanio Titanium	A	AL12
■ Selce Flint Grey	V	AL13
■ Silver Dark Dark Silver	V	AL14
■ Oro Rosa Pink Gold	V	AL17
■ Rame Copper	V	AL23
■ Ottone Brass	V	AL24
■ Umber Umber	V	AL26

ALTEZZA, LARGHEZZA E PROFONDITA'
HEIGHT, WIDTH AND DEPTH
H.1680 L.1200 P.310 - H.1680 W.1200 D.310

CODICE ARTICOLO E7807122
ITEM NUMBER

FINITURA FINISH	A/V*	OPZIONE COLORE COLOUR OPTION
■ Nero Black	A	AL11
■ Titanio Titanium	A	AL12
■ Selce Flint Grey	V	AL13
■ Silver Dark Dark Silver	V	AL14
■ Oro Rosa Pink Gold	V	AL17
■ Rame Copper	V	AL23
■ Ottone Brass	V	AL24
■ Umber Umber	V	AL26

Elementi sottopenisola H 480

Under-peninsula elements

*A/V: A=ANODIZZATO V=VERNICIATO
ANODIZED PAINTED

CON SCHIENALE
WITH BACK PANEL

ALTEZZA, LARGHEZZA E PROFONDITA'
HEIGHT, WIDTH AND DEPTH
H.480 L.600 P.310 - H.480 W.600 D.310

CODICE ARTICOLO E7822060
ITEM NUMBER

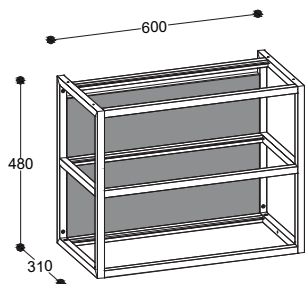

FINITURA FINISH	A/V*	OPZIONE COLORE COLOUR OPTION
Nero Black	A	AL11
Titanio Titanium	A	AL12
Selce Flint Grey	V	AL13
Silver Dark Dark Silver	V	AL14
Oro Rosa Pink Gold	V	AL17
Rame Copper	V	AL23
Ottone Brass	V	AL24
Umber Umber	V	AL26

ALTEZZA, LARGHEZZA E PROFONDITA'
HEIGHT, WIDTH AND DEPTH
H.480 L.900 P.310 - H.480 W.900 D.310

CODICE ARTICOLO E7822090
ITEM NUMBER

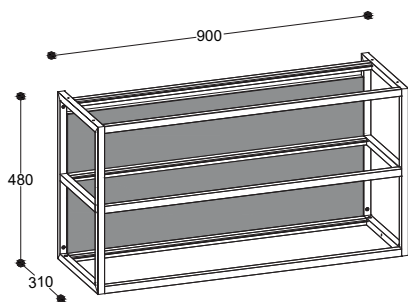

FINITURA FINISH	A/V*	OPZIONE COLORE COLOUR OPTION
Nero Black	A	AL11
Titanio Titanium	A	AL12
Selce Flint Grey	V	AL13
Silver Dark Dark Silver	V	AL14
Oro Rosa Pink Gold	V	AL17
Rame Copper	V	AL23
Ottone Brass	V	AL24
Umber Umber	V	AL26

FINITURE PER RIPIANI VETRO

FINISHES FOR GLASS SHELVES

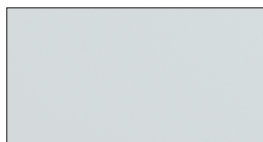

VETRO TRASPARENTE
TRANSPARENT GLASS



VETRO FUME' TRASPARENTE
TRANSPARENT SMOKED GLASS



VETRO BRONZO TRASPARENTE
TRANSPARENT BRONZE GLASS

Pensili alti con schiena personalizzata e ripiani vetro

Tall wall units with personalized back panel and glass shelves

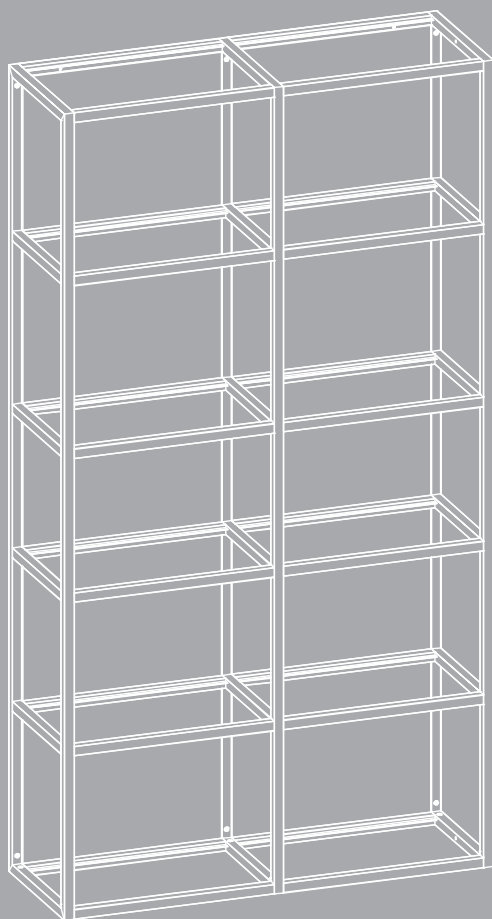

Pensili H 720

Wall Units

*A/V: A=ANODIZZATO V=VERNICIATO
ANODIZED PAINTED

N.B.: PER I COLORI DELLE SCHIENE VEDI PAG:74-77
NOTE: FOR THE BACK PANEL COLORS SEE PAGE 74-77

ALTEZZA, LARGHEZZA E PROFONDITA'

HEIGHT, WIDTH AND DEPTH

H.720 L.300 P.310 - H.720 W.300 D.310

CODICE ARTICOLO E7754030

ITEM NUMBER

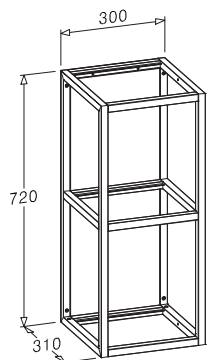

FINITURA FINISH	A/V*	OPZIONE COLORE COLOUR OPTION
■ Nero Black	A	AL11
■ Titanio Titanium	A	AL12
■ Selce Flint Grey	V	AL13
■ Silver Dark Dark Silver	V	AL14
■ Oro Rosa Pink Gold	V	AL17
■ Rame Copper	V	AL23
■ Ottone Brass	V	AL24
■ Umber Umber	V	AL26

ALTEZZA, LARGHEZZA E PROFONDITA'

HEIGHT, WIDTH AND DEPTH

H.720 L.600 P.310 - H.720 W.600 D.310

CODICE ARTICOLO E7754060

ITEM NUMBER

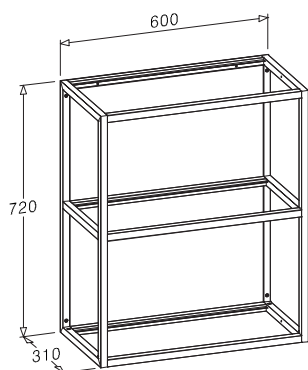

FINITURA FINISH	A/V*	OPZIONE COLORE COLOUR OPTION
■ Nero Black	A	AL11
■ Titanio Titanium	A	AL12
■ Selce Flint Grey	V	AL13
■ Silver Dark Dark Silver	V	AL14
■ Oro Rosa Pink Gold	V	AL17
■ Rame Copper	V	AL23
■ Ottone Brass	V	AL24
■ Umber Umber	V	AL26

Pensili H 960

Wall Units

*A/V: A=ANODIZZATO V=VERNICIATO
ANODIZED PAINTED

N.B.: PER I COLORI DELLE SCHIENE VEDI PAG:74-77
NOTE: FOR THE BACK PANEL COLORS SEE PAGE 74-77

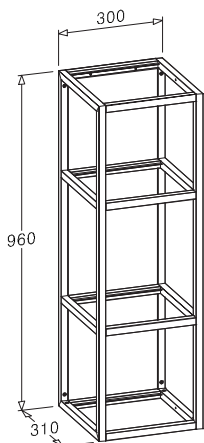

ALTEZZA, LARGHEZZA E PROFONDITA'

HEIGHT, WIDTH AND DEPTH

H.960 L.300 P.310 - H.960 W.300 D.310

CODICE ARTICOLO E7755030

ITEM NUMBER

FINITURA FINISH	A/V*	OPZIONE COLORE COLOUR OPTION
■ Nero Black	A	AL11
■ Titanio Titanium	A	AL12
■ Selce Flint Grey	V	AL13
■ Silver Dark Dark Silver	V	AL14
■ Oro Rosa Pink Gold	V	AL17
■ Rame Copper	V	AL23
■ Ottone Brass	V	AL24
■ Umber Umber	V	AL26

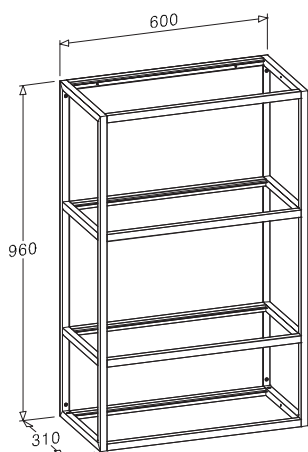

ALTEZZA, LARGHEZZA E PROFONDITA'

HEIGHT, WIDTH AND DEPTH

H.960 L.600 P.310 - H.960 W.600 D.310

CODICE ARTICOLO E7755060

ITEM NUMBER

FINITURA FINISH	A/V*	OPZIONE COLORE COLOUR OPTION
■ Nero Black	A	AL11
■ Titanio Titanium	A	AL12
■ Selce Flint Grey	V	AL13
■ Silver Dark Dark Silver	V	AL14
■ Oro Rosa Pink Gold	V	AL17
■ Rame Copper	V	AL23
■ Ottone Brass	V	AL24
■ Umber Umber	V	AL26

FINITURE PER RIPIANI VETRO

FINISHES FOR GLASS SHELVES

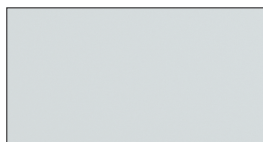

VETRO TRASPARENTE
TRANSPARENT GLASS



VETRO FUME' TRASPARENTE
TRANSPARENT SMOKED GLASS



VETRO BRONZO TRASPARENTE
TRANSPARENT BRONZE GLASS

Pensili H 1020
Wall Units

***A/V:** A=ANODIZZATO V=VERNICIATO
ANODIZED PAINTED

N.B.: PER I COLORI DELLE SCHIENE VEDI PAG:74-77
NOTE: FOR THE BACK PANEL COLORS SEE PAGE 74-77

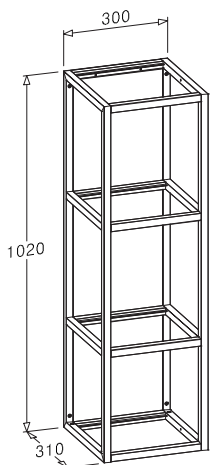

ALTEZZA, LARGHEZZA E PROFONDITA'
HEIGHT, WIDTH AND DEPTH
H.1020 L.300 P.310 - H.1020 W.300 D.310

CODICE ARTICOLO E7756030
ITEM NUMBER

FINITURA FINISH	A/V*	OPZIONE COLORE COLOUR OPTION
■ Nero Black	A	AL11
■ Titanio Titanium	A	AL12
■ Selce Flint Grey	V	AL13
■ Silver Dark Dark Silver	V	AL14
■ Oro Rosa Pink Gold	V	AL17
■ Rame Copper	V	AL23
■ Ottone Brass	V	AL24
■ Umber Umber	V	AL26

Pensili H 1320

Wall Units

*A/V: A=ANODIZZATO V=VERNICIATO
ANODIZED PAINTED

N.B.: PER I COLORI DELLE SCHIENE VEDI PAG:74-77
NOTE: FOR THE BACK PANEL COLORS SEE PAGE 74-77

ALTEZZA, LARGHEZZA E PROFONDITA'

HEIGHT, WIDTH AND DEPTH

H.1320 L.600 P.310 - H.1320 W.600 D.310

CODICE ARTICOLO E7756160

ITEM NUMBER

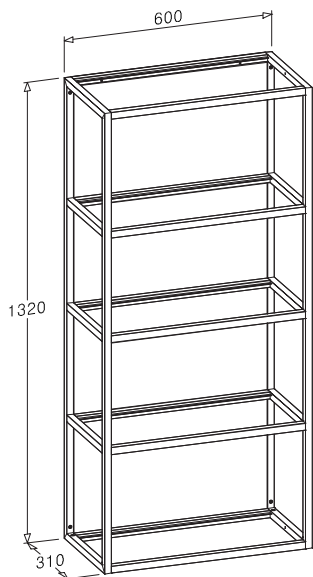

FINITURA FINISH	A/V*	OPZIONE COLORE COLOUR OPTION
■ Nero Black	A	AL11
■ Titanio Titanium	A	AL12
■ Selce Flint Grey	V	AL13
■ Silver Dark Dark Silver	V	AL14
■ Oro Rosa Pink Gold	V	AL17
■ Rame Copper	V	AL23
■ Ottone Brass	V	AL24
■ Umber Umber	V	AL26

FINITURE PER RIPIANI VETRO

FINISHES FOR GLASS SHELVES

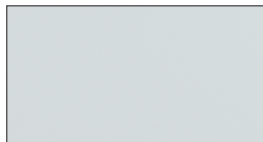

VETRO TRASPARENTE
TRANSPARENT GLASS



VETRO FUME' TRASPARENTE
TRANSPARENT SMOKED GLASS



VETRO BRONZO TRASPARENTE
TRANSPARENT BRONZE GLASS

Pensili H 1680

Wall Units

*A/V: A=ANODIZZATO V=VERNICIATO
ANODIZED PAINTED

N.B.: PER I COLORI DELLE SCHIENE VEDI PAG:74-77
NOTE: FOR THE BACK PANEL COLORS SEE PAGE 74-77

ALTEZZA, LARGHEZZA E PROFONDITA'

HEIGHT, WIDTH AND DEPTH

H.1680 L.600 P.310 - H.1680 W.600 D.310

CODICE ARTICOLO E7757060

ITEM NUMBER

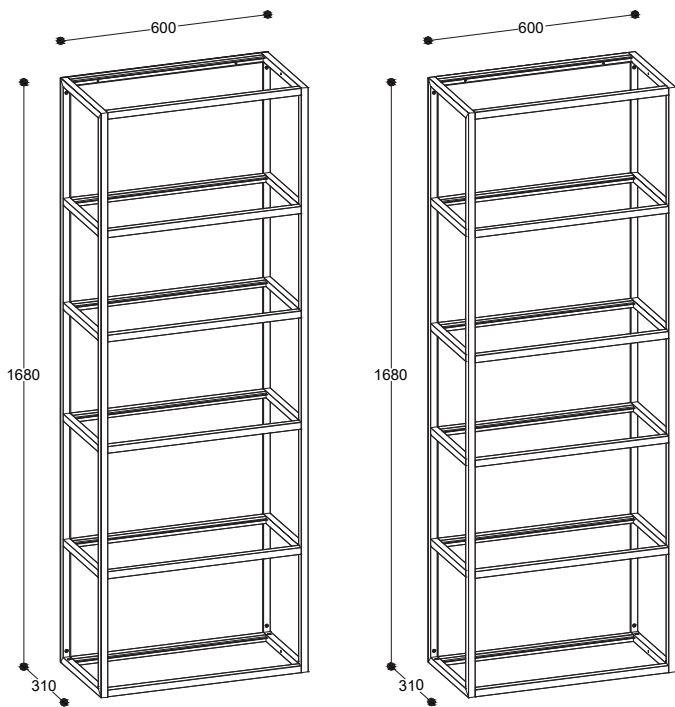

FINITURA FINISH	A/V*	OPZIONE COLORE COLOUR OPTION
Nero Black	A	AL11
Titanio Titanium	A	AL12
Selce Flint Grey	V	AL13
Silver Dark Dark Silver	V	AL14
Oro Rosa Pink Gold	V	AL17
Rame Copper	V	AL23
Ottone Brass	V	AL24
Umber Umber	V	AL26

ALTEZZA, LARGHEZZA E PROFONDITA'

HEIGHT, WIDTH AND DEPTH

H.1680 L.600 P.310 - H.1680 W.600 D.310

RIALZATO RAISED

CODICE ARTICOLO E7757063

ITEM NUMBER

**PER ALLINEAMENTO UTILIZZARE
MODULO H 36 (vedi pag.79-80)
FOR ALIGNMENT USE
MODULE H 36 (see page 79-80)**

**RIALZATO
PER ALLINEAMENTO UTILIZZARE
MODULO H 72 (vedi pag.79-80)
RAISED
FOR ALIGNMENT USE
MODULE H 72 (see page 79-80)**

FINITURA FINISH	A/V*	OPZIONE COLORE COLOUR OPTION
Nero Black	A	AL11
Titanio Titanium	A	AL12
Selce Flint Grey	V	AL13
Silver Dark Dark Silver	V	AL14
Oro Rosa Pink Gold	V	AL17
Rame Copper	V	AL23
Ottone Brass	V	AL24
Umber Umber	V	AL26

ALTEZZA, LARGHEZZA E PROFONDITA'

HEIGHT, WIDTH AND DEPTH

H.1680 L.900 P.310 - H.1680 W.900 D.310

CODICE ARTICOLO E7757090

ITEM NUMBER

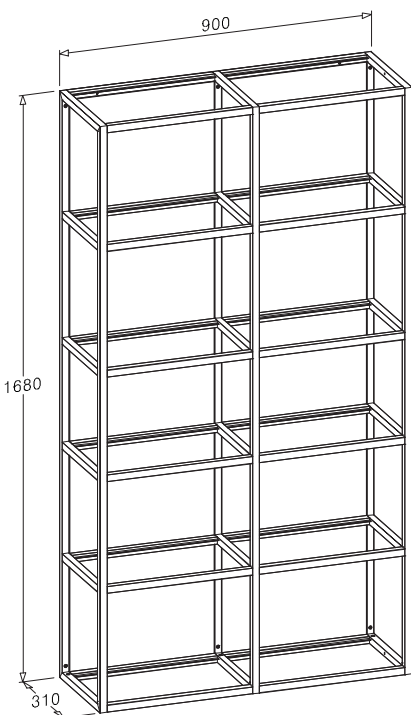

FINITURA FINISH	A/V*	OPZIONE COLORE COLOUR OPTION
Nero Black	A	AL11
Titanio Titanium	A	AL12
Selce Flint Grey	V	AL13
Silver Dark Dark Silver	V	AL14
Oro Rosa Pink Gold	V	AL17
Rame Copper	V	AL23
Ottone Brass	V	AL24
Umber Umber	V	AL26

Pensili H 2040

Wall Units

*A/V: A=ANODIZZATO V=VERNICIATO
ANODIZED PAINTED

N.B.: PER I COLORI DELLE SCHIENE VEDI PAG:74-77
NOTE: FOR THE BACK PANEL COLORS SEE PAGE 74-77

ALTEZZA, LARGHEZZA E PROFONDITA'

HEIGHT, WIDTH AND DEPTH

H.2040 L.600 P.310 - H.2040 W.600 D.310

CODICE ARTICOLO E7788060

ITEM NUMBER

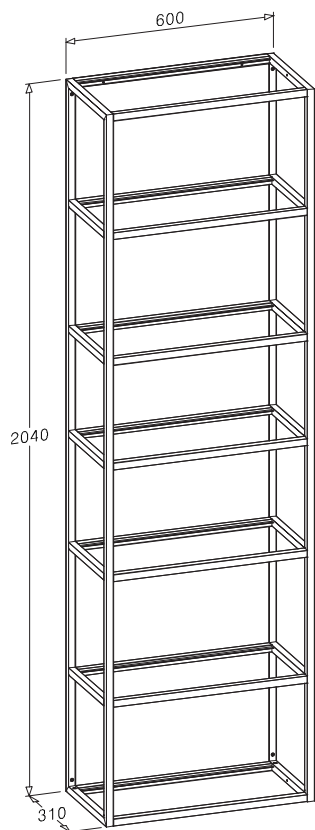

FINITURA FINISH	A/V*	OPZIONE COLORE COLOUR OPTION
■ Nero Black	A	AL11
■ Titanio Titanium	A	AL12
■ Selce Flint Grey	V	AL13
■ Silver Dark Dark Silver	V	AL14
■ Oro Rosa Pink Gold	V	AL17
■ Rame Copper	V	AL23
■ Ottone Brass	V	AL24
■ Umber	V	AL26

ALTEZZA, LARGHEZZA E PROFONDITA'

HEIGHT, WIDTH AND DEPTH

H.2040 L.900 P.310 - H.2040 W.900 D.310

CODICE ARTICOLO E7788090

ITEM NUMBER

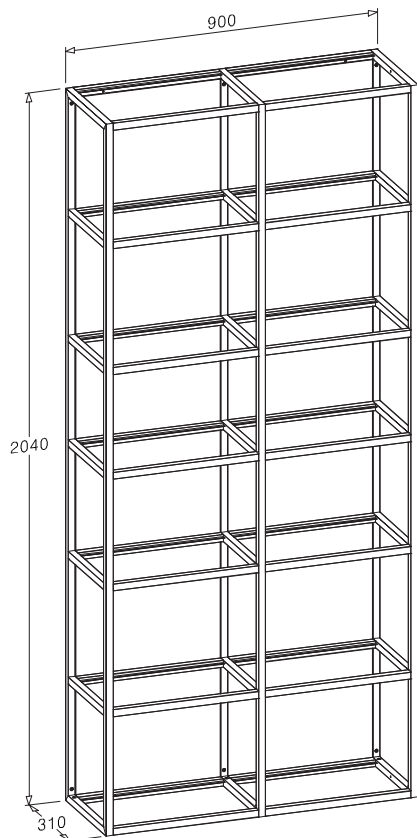

FINITURA FINISH	A/V*	OPZIONE COLORE COLOUR OPTION
■ Nero Black	A	AL11
■ Titanio Titanium	A	AL12
■ Selce Flint Grey	V	AL13
■ Silver Dark Dark Silver	V	AL14
■ Oro Rosa Pink Gold	V	AL17
■ Rame Copper	V	AL23
■ Ottone Brass	V	AL24
■ Umber	V	AL26

FINITURE PER RIPIANI VETRO

FINISHES FOR GLASS SHELVES

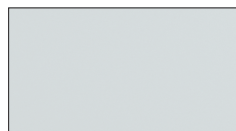

VETRO TRASPARENTE
TRANSPARENT GLASS



VETRO FUME' TRASPARENTE
TRANSPARENT SMOKED GLASS



VETRO BRONZO TRASPARENTE
TRANSPARENT BRONZE GLASS

Pensili H 1680 elementi speciali *A/V: A=ANODIZZATO V=VERNICIATO
 Wall Units - Special elements ANODIZED PAINTED

N.B.: PER I COLORI DELLE SCHIENE VEDI PAG:74-77
NOTE: FOR THE BACK PANEL COLORS SEE PAGE 74-77

ALTEZZA, LARGHEZZA E PROFONDITA'
HEIGHT, WIDTH AND DEPTH
 H.1680 L.1200 P.310 - H.1680 W.1200 D.310

CODICE ARTICOLO E7757121
ITEM NUMBER

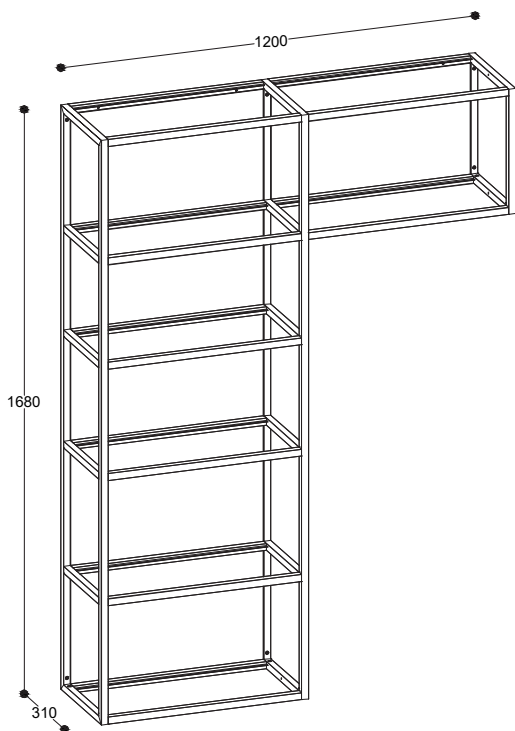

VERSO DX (esempio di utilizzo vedi pag.79-80)
TO THE RIGHT (example of use see page 79-80)

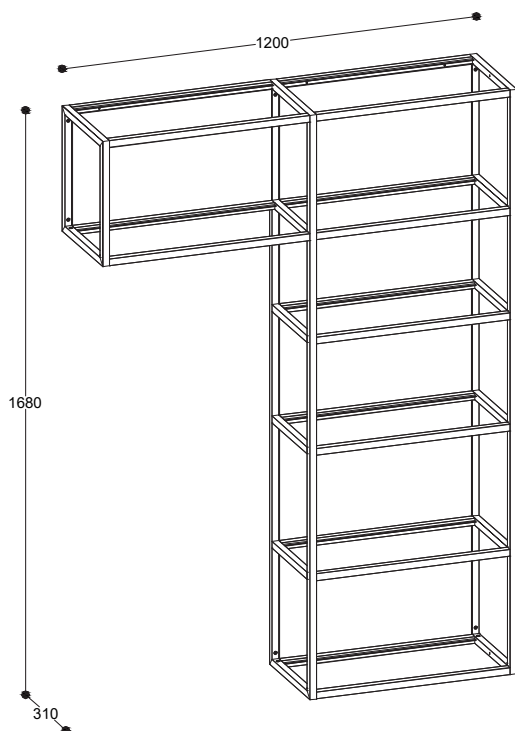

VERSO SX (esempio di utilizzo vedi pag.79-80)
TO THE LEFT (example of use see page 79-80)

ALTEZZA, LARGHEZZA E PROFONDITA'
HEIGHT, WIDTH AND DEPTH
 H.1680 L.1200 P.310 - H.1680 W.1200 D.310

CODICE ARTICOLO E7757122
ITEM NUMBER

FINITURA FINISH	A/V*	OPZIONE COLORE COLOUR OPTION
■ Nero Black	A	AL11
■ Titanio Titanium	A	AL12
■ Selce Flint Grey	V	AL13
■ Silver Dark Dark Silver	V	AL14
■ Oro Rosa Pink Gold	V	AL17
■ Rame Copper	V	AL23
■ Ottone Brass	V	AL24
■ Umber Umber	V	AL26

FINITURA FINISH	A/V*	OPZIONE COLORE COLOUR OPTION
■ Nero Black	A	AL11
■ Titanio Titanium	A	AL12
■ Selce Flint Grey	V	AL13
■ Silver Dark Dark Silver	V	AL14
■ Oro Rosa Pink Gold	V	AL17
■ Rame Copper	V	AL23
■ Ottone Brass	V	AL24
■ Umber Umber	V	AL26

Elementi sottopenisola H 480
Under-peninsula elements

*A/V: A=ANODIZZATO V=VERNICIATO
ANODIZED PAINTED

N.B.: PER I COLORI DELLE SCHIENE VEDI PAG:74-77
NOTE: FOR THE BACK PANEL COLORS SEE PAGE 74-77

ALTEZZA, LARGHEZZA E PROFONDITA'

HEIGHT, WIDTH AND DEPTH

H.480 L.600 P.310 - H.480 W.600 D.310

CODICE ARTICOLO E7772060

ITEM NUMBER

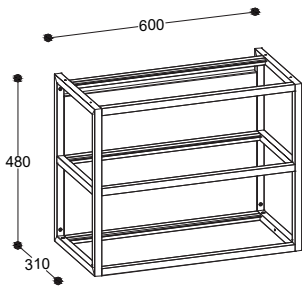

FINITURA FINISH | **A/V*** | **OPZIONE COLORE COLOUR OPTION**

Nero Black	A	AL11
Titanio Titanium	A	AL12
Selce Flint Grey	V	AL13
Silver Dark Dark Silver	V	AL14
Oro Rosa Pink Gold	V	AL17
Rame Copper	V	AL23
Ottone Brass	V	AL24
Umber Umber	V	AL26

ALTEZZA, LARGHEZZA E PROFONDITA'

HEIGHT, WIDTH AND DEPTH

H.480 L.900 P.310 - H.480 W.900 D.310

CODICE ARTICOLO E7772090

ITEM NUMBER

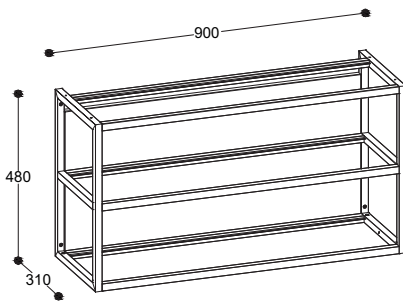

FINITURA FINISH | **A/V*** | **OPZIONE COLORE COLOUR OPTION**

Nero Black	A	AL11
Titanio Titanium	A	AL12
Selce Flint Grey	V	AL13
Silver Dark Dark Silver	V	AL14
Oro Rosa Pink Gold	V	AL17
Rame Copper	V	AL23
Ottone Brass	V	AL24
Umber Umber	V	AL26

FINITURE PER RIPIANI VETRO

FINISHES FOR GLASS SHELVES

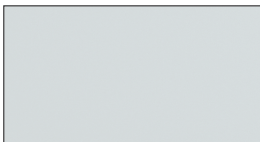

VETRO TRASPARENTE
TRANSPARENT GLASS



VETRO FUME' TRASPARENTE
TRANSPARENT SMOKED GLASS



VETRO BRONZO TRASPARENTE
TRANSPARENT BRONZE GLASS

Pensili con schienale e fondo alluminio, ripiano vetro
Wall units with aluminum back panel and bottom, glass shelf

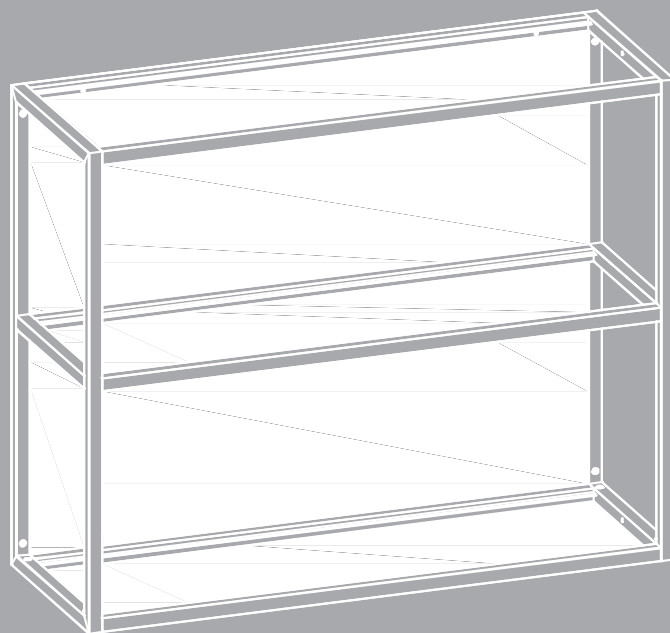

Pensili H 240

Wall Units

*A/V: A=ANODIZZATO V=VERNICIATO
ANODIZED PAINTED

CON SCHIENALE E FONDO
WITH BACK PANEL AND BOTTOM

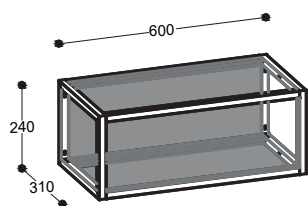

ALTEZZA, LARGHEZZA E PROFONDITA'
HEIGHT, WIDTH AND DEPTH
H.240 L.600 P.310 - H.240 W.600 D.310

CODICE ARTICOLO E7740060
ITEM NUMBER

FINITURA FINISH	A/V*	OPZIONE COLORE COLOUR OPTION
■ Nero Black	A	AL11
■ Titanio Titanium	A	AL12
■ Selce Flint Grey	V	AL13
■ Silver Dark Dark Silver	V	AL14
■ Oro Rosa Pink Gold	V	AL17
■ Rame Copper	V	AL23
■ Ottone Brass	V	AL24
■ Umber Umber	V	AL26

ALTEZZA, LARGHEZZA E PROFONDITA'
HEIGHT, WIDTH AND DEPTH
H.240 L.900 P.310 - H.240 W.900 D.310

CODICE ARTICOLO E7740090
ITEM NUMBER

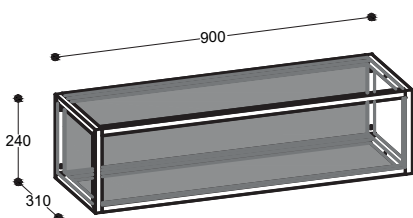

FINITURA FINISH	A/V*	OPZIONE COLORE COLOUR OPTION
■ Nero Black	A	AL11
■ Titanio Titanium	A	AL12
■ Selce Flint Grey	V	AL13
■ Silver Dark Dark Silver	V	AL14
■ Oro Rosa Pink Gold	V	AL17
■ Rame Copper	V	AL23
■ Ottone Brass	V	AL24
■ Umber Umber	V	AL26

ALTEZZA, LARGHEZZA E PROFONDITA'
HEIGHT, WIDTH AND DEPTH
H.240 L.1200 P.310 - H.240 W.1200 D.310

CODICE ARTICOLO E7740120
ITEM NUMBER

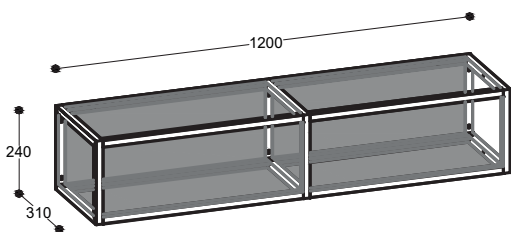

FINITURA FINISH	A/V*	OPZIONE COLORE COLOUR OPTION
■ Nero Black	A	AL11
■ Titanio Titanium	A	AL12
■ Selce Flint Grey	V	AL13
■ Silver Dark Dark Silver	V	AL14
■ Oro Rosa Pink Gold	V	AL17
■ Rame Copper	V	AL23
■ Ottone Brass	V	AL24
■ Umber Umber	V	AL26

Pensili H 240

Wall Units

*A/V: A=ANODIZZATO V=VERNICIATO
ANODIZED PAINTED

CON SCHIENALE E FONDO
WITH BACK PANEL AND BOTTOM

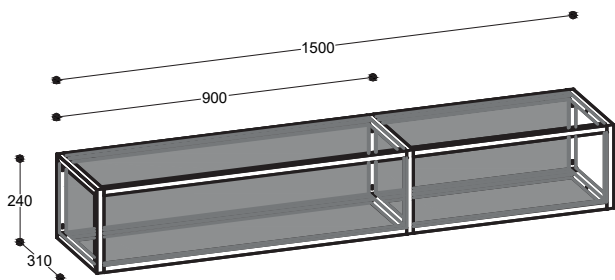

**VERSO DX
TO THE RIGHT**

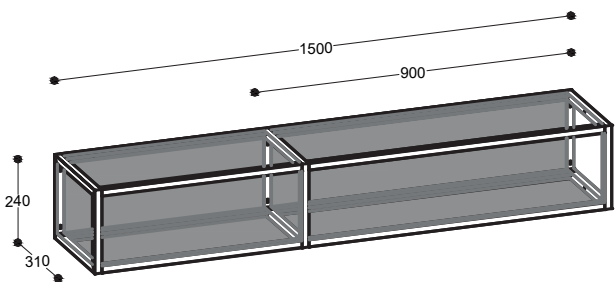

**VERSO SX
TO THE LEFT**

ALTEZZA, LARGHEZZA E PROFONDITA'

HEIGHT, WIDTH AND DEPTH

H.240 L.1500 P.310 - H.240 W.1500 D.310

CODICE ARTICOLO E7740151

ITEM NUMBER

FINITURA FINISH	A/V*	OPZIONE COLORE COLOUR OPTION
Nero Black	A	AL11
Titanio Titanium	A	AL12
Selce Flint Grey	V	AL13
Silver Dark Dark Silver	V	AL14
Oro Rosa Pink Gold	V	AL17
Rame Copper	V	AL23
Ottone Brass	V	AL24
Umber Umber	V	AL26

ALTEZZA, LARGHEZZA E PROFONDITA'

HEIGHT, WIDTH AND DEPTH

H.240 L.1500 P.310 - H.240 W.1500 D.310

CODICE ARTICOLO E7740152

ITEM NUMBER

FINITURA FINISH	A/V*	OPZIONE COLORE COLOUR OPTION
Nero Black	A	AL11
Titanio Titanium	A	AL12
Selce Flint Grey	V	AL13
Silver Dark Dark Silver	V	AL14
Oro Rosa Pink Gold	V	AL17
Rame Copper	V	AL23
Ottone Brass	V	AL24
Umber Umber	V	AL26

FINITURE PER RIPIANI VETRO

FINISHES FOR GLASS SHELVES

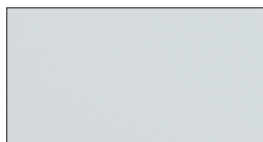

VETRO TRASPARENTE
TRANSPARENT GLASS



VETRO FUME' TRASPARENTE
TRANSPARENT SMOKED GLASS



VETRO BRONZO TRASPARENTE
TRANSPARENT BRONZE GLASS

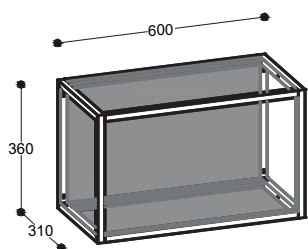

ALTEZZA, LARGHEZZA E PROFONDITA'
HEIGHT, WIDTH AND DEPTH
H.360 L.600 P.310 - H.360 W.600 D.310

CODICE ARTICOLO E7741060
ITEM NUMBER

FINITURA FINISH	A/V*	OPZIONE COLORE COLOUR OPTION
Nero Black	A	AL11
Titanio Titanium	A	AL12
Selce Flint Grey	V	AL13
Silver Dark Dark Silver	V	AL14
Oro Rosa Pink Gold	V	AL17
Rame Copper	V	AL23
Ottone Brass	V	AL24
Umber Umber	V	AL26

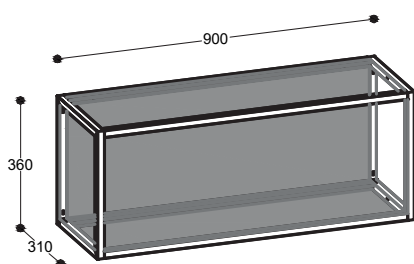

ALTEZZA, LARGHEZZA E PROFONDITA'
HEIGHT, WIDTH AND DEPTH
H.360 L.900 P.310 - H.360 W.900 D.310

CODICE ARTICOLO E7741090
ITEM NUMBER

FINITURA FINISH	A/V*	OPZIONE COLORE COLOUR OPTION
Nero Black	A	AL11
Titanio Titanium	A	AL12
Selce Flint Grey	V	AL13
Silver Dark Dark Silver	V	AL14
Oro Rosa Pink Gold	V	AL17
Rame Copper	V	AL23
Ottone Brass	V	AL24
Umber Umber	V	AL26

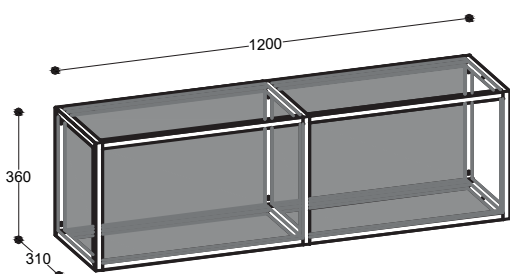

ALTEZZA, LARGHEZZA E PROFONDITA'
HEIGHT, WIDTH AND DEPTH
H.360 L.1200 P.310 - H.360 W.1200 D.310

CODICE ARTICOLO E7741120
ITEM NUMBER

FINITURA FINISH	A/V*	OPZIONE COLORE COLOUR OPTION
Nero Black	A	AL11
Titanio Titanium	A	AL12
Selce Flint Grey	V	AL13
Silver Dark Dark Silver	V	AL14
Oro Rosa Pink Gold	V	AL17
Rame Copper	V	AL23
Ottone Brass	V	AL24
Umber Umber	V	AL26

Pensili H 360
Wall Units

*A/V: A=ANODIZZATO V=VERNICIATO
ANODIZED PAINTED

CON SCHIENALE E FONDO
WITH BACK PANEL AND BOTTOM

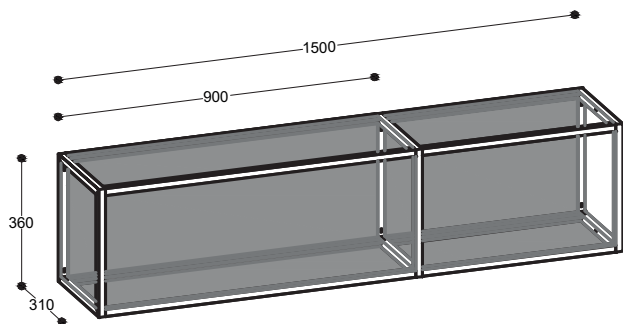

**VERSÒ DX
TO THE RIGHT**

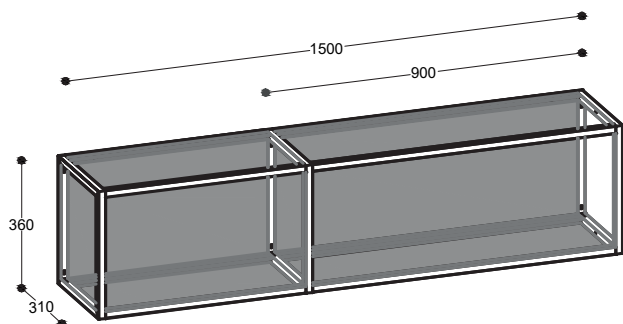

**VERSÒ SX
TO THE LEFT**

ALTEZZA, LARGHEZZA E PROFONDITA'
HEIGHT, WIDTH AND DEPTH
H.360 L.1500 P.310 - H.360 W.1500 D.310

CODICE ARTICOLO E7741151
ITEM NUMBER

FINITURA FINISH	A/V*	OPZIONE COLORE COLOUR OPTION
■ Nero Black	A	AL11
■ Titanio Titanium	A	AL12
■ Selce Flint Grey	V	AL13
■ Silver Dark Dark Silver	V	AL14
■ Oro Rosa Pink Gold	V	AL17
■ Rame Copper	V	AL23
■ Ottone Brass	V	AL24
■ Umber Umber	V	AL26

ALTEZZA, LARGHEZZA E PROFONDITA'
HEIGHT, WIDTH AND DEPTH
H.360 L.1500 P.310 - H.360 W.1500 D.310

CODICE ARTICOLO E7741152
ITEM NUMBER

FINITURA FINISH	A/V*	OPZIONE COLORE COLOUR OPTION
■ Nero Black	A	AL11
■ Titanio Titanium	A	AL12
■ Selce Flint Grey	V	AL13
■ Silver Dark Dark Silver	V	AL14
■ Oro Rosa Pink Gold	V	AL17
■ Rame Copper	V	AL23
■ Ottone Brass	V	AL24
■ Umber Umber	V	AL26

FINITURE PER RIPIANI VETRO
FINISHES FOR GLASS SHELVES

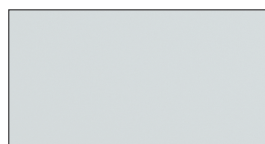

VETRO TRASPARENTE
TRANSPARENT GLASS



VETRO FUME' TRASPARENTE
TRANSPARENT SMOKED GLASS



VETRO BRONZO TRASPARENTE
TRANSPARENT BRONZE GLASS

Pensili con schienale personalizzato
fondo alluminio e ripiano vetro
Wall units with personalized back panel,
aluminum bottom and glass shelf

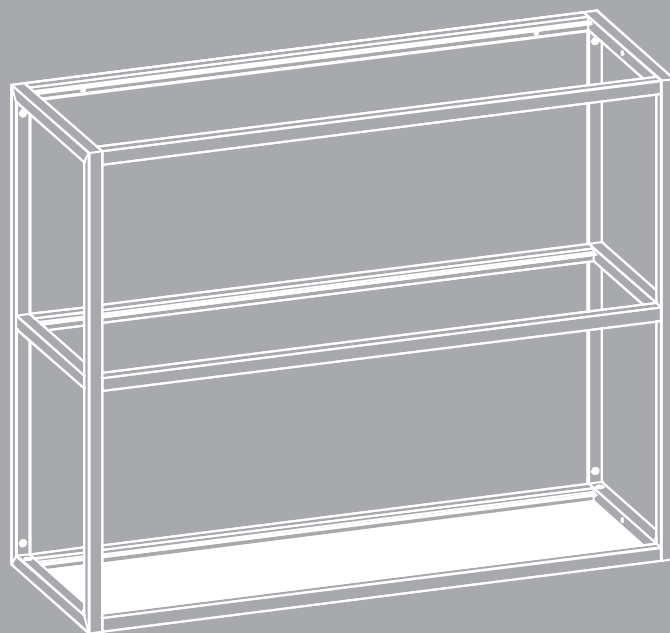

Pensili H 240

Wall Units

*A/V: A=ANODIZZATO V=VERNICIATO
ANODIZED PAINTED

N.B.: PER I COLORI DELLE SCHIENE VEDI PAG:74-77
NOTE: FOR THE BACK PANEL COLORS SEE PAGE 74-77

ALTEZZA, LARGHEZZA E PROFONDITA'

HEIGHT, WIDTH AND DEPTH

H.240 L.600 P.310 - H.240 W.600 D.310

CODICE ARTICOLO E7730060

ITEM NUMBER

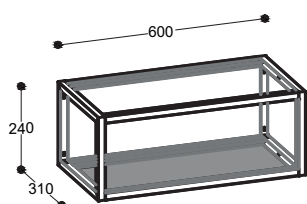

FINITURA FINISH	A/V*	OPZIONE COLORE COLOUR OPTION
Nero Black	A	AL11
Titanio Titanium	A	AL12
Selce Flint Grey	V	AL13
Silver Dark Dark Silver	V	AL14
Oro Rosa Pink Gold	V	AL17
Rame Copper	V	AL23
Ottone Brass	V	AL24
Umber Umber	V	AL26

ALTEZZA, LARGHEZZA E PROFONDITA'

HEIGHT, WIDTH AND DEPTH

H.240 L.900 P.310 - H.240 W.900 D.310

CODICE ARTICOLO E7730090

ITEM NUMBER

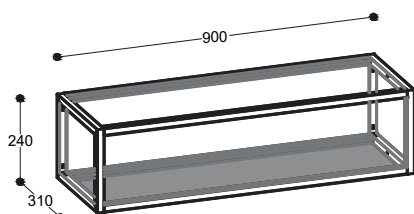

FINITURA FINISH	A/V*	OPZIONE COLORE COLOUR OPTION
Nero Black	A	AL11
Titanio Titanium	A	AL12
Selce Flint Grey	V	AL13
Silver Dark Dark Silver	V	AL14
Oro Rosa Pink Gold	V	AL17
Rame Copper	V	AL23
Ottone Brass	V	AL24
Umber Umber	V	AL26

ALTEZZA, LARGHEZZA E PROFONDITA'

HEIGHT, WIDTH AND DEPTH

H.240 L.1200 P.310 - H.240 W.1200 D.310

CODICE ARTICOLO E7730120

ITEM NUMBER

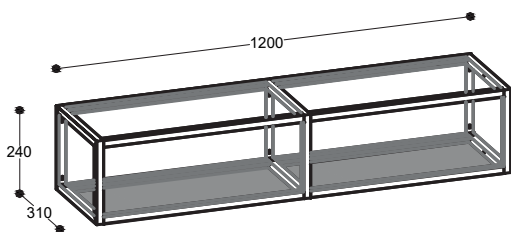

FINITURA FINISH	A/V*	OPZIONE COLORE COLOUR OPTION
Nero Black	A	AL11
Titanio Titanium	A	AL12
Selce Flint Grey	V	AL13
Silver Dark Dark Silver	V	AL14
Oro Rosa Pink Gold	V	AL17
Rame Copper	V	AL23
Ottone Brass	V	AL24
Umber Umber	V	AL26

Pensili H 240

Wall Units

*A/V: A=ANODIZZATO V=VERNICIATO
ANODIZED PAINTED

N.B.: PER I COLORI DELLE SCHIENE VEDI PAG:74-77
NOTE: FOR THE BACK PANEL COLORS SEE PAGE 74-77

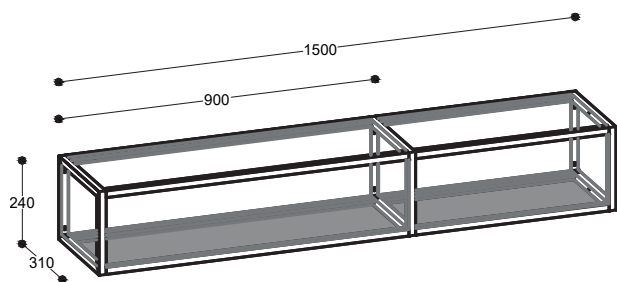

VERSO DX
TO THE RIGHT

ALTEZZA, LARGHEZZA E PROFONDITA'

HEIGHT, WIDTH AND DEPTH

H.240 L.1500 P.310 - H.240 W.1500 D.310

CODICE ARTICOLO E7730151

ITEM NUMBER

FINITURA FINISH	A/V*	OPZIONE COLORE COLOUR OPTION
Nero Black	A	AL11
Titanio Titanium	A	AL12
Selce Flint Grey	V	AL13
Silver Dark Dark Silver	V	AL14
Oro Rosa Pink Gold	V	AL17
Rame Copper	V	AL23
Ottone Brass	V	AL24
Umber Umber	V	AL26

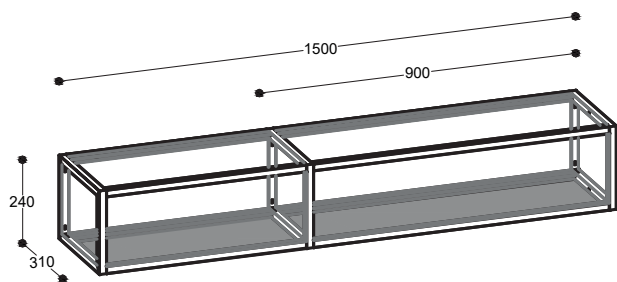

VERSO SX
TO THE LEFT

ALTEZZA, LARGHEZZA E PROFONDITA'

HEIGHT, WIDTH AND DEPTH

H.240 L.1500 P.310 - H.240 W.1500 D.310

CODICE ARTICOLO E7730152

ITEM NUMBER

FINITURA FINISH	A/V*	OPZIONE COLORE COLOUR OPTION
Nero Black	A	AL11
Titanio Titanium	A	AL12
Selce Flint Grey	V	AL13
Silver Dark Dark Silver	V	AL14
Oro Rosa Pink Gold	V	AL17
Rame Copper	V	AL23
Ottone Brass	V	AL24
Umber Umber	V	AL26

FINITURE PER RIPIANI VETRO

FINISHES FOR GLASS SHELVES

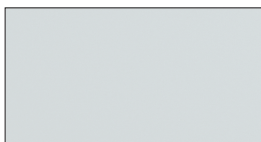

VETRO TRASPARENTE
TRANSPARENT GLASS



VETRO FUME' TRASPARENTE
TRANSPARENT SMOKED GLASS



VETRO BRONZO TRASPARENTE
TRANSPARENT BRONZE GLASS

Pensili H 360
Wall Units

*A/V: A=ANODIZZATO V=VERNICIATO
ANODIZED PAINTED

N.B.: PER I COLORI DELLE SCHIENE VEDI PAG:74-77
NOTE: FOR THE BACK PANEL COLORS SEE PAGE 74-77

ALTEZZA, LARGHEZZA E PROFONDITA'
HEIGHT, WIDTH AND DEPTH
H.360 L.600 P.310 - H.360 W.600 D.310

CODICE ARTICOLO E7731060
ITEM NUMBER

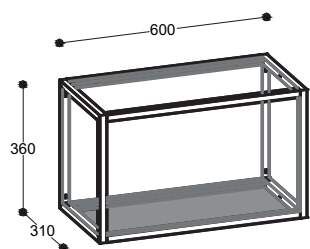

FINITURA FINISH	A/V*	OPZIONE COLORE COLOUR OPTION
Nero Black	A	AL11
Titanio Titanium	A	AL12
Selce Flint Grey	V	AL13
Silver Dark Dark Silver	V	AL14
Oro Rosa Pink Gold	V	AL17
Rame Copper	V	AL23
Ottone Brass	V	AL24
Umber Umber	V	AL26

ALTEZZA, LARGHEZZA E PROFONDITA'
HEIGHT, WIDTH AND DEPTH
H.360 L.900 P.310 - H.360 W.900 D.310

CODICE ARTICOLO E7731090
ITEM NUMBER

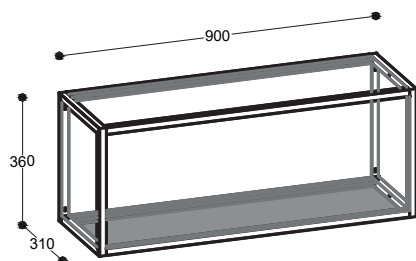

FINITURA FINISH	A/V*	OPZIONE COLORE COLOUR OPTION
Nero Black	A	AL11
Titanio Titanium	A	AL12
Selce Flint Grey	V	AL13
Silver Dark Dark Silver	V	AL14
Oro Rosa Pink Gold	V	AL17
Rame Copper	V	AL23
Ottone Brass	V	AL24
Umber Umber	V	AL26

ALTEZZA, LARGHEZZA E PROFONDITA'
HEIGHT, WIDTH AND DEPTH
H.360 L.1200 P.310 - H.360 W.1200 D.310

CODICE ARTICOLO E7731120
ITEM NUMBER

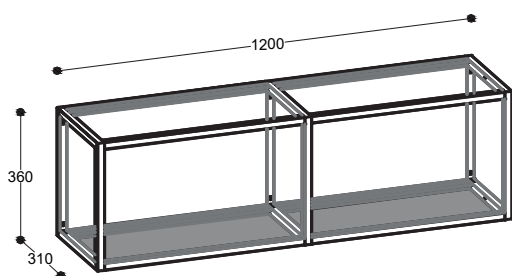

FINITURA FINISH	A/V*	OPZIONE COLORE COLOUR OPTION
Nero Black	A	AL11
Titanio Titanium	A	AL12
Selce Flint Grey	V	AL13
Silver Dark Dark Silver	V	AL14
Oro Rosa Pink Gold	V	AL17
Rame Copper	V	AL23
Ottone Brass	V	AL24
Umber Umber	V	AL26

Pensili H 360
Wall Units

*A/V: A=ANODIZZATO V=VERNICIATO
ANODIZED PAINTED

N.B.: PER I COLORI DELLE SCHIENE VEDI PAG:74-77
NOTE: FOR THE BACK PANEL COLORS SEE PAGE 74-77

ALTEZZA, LARGHEZZA E PROFONDITA'

HEIGHT, WIDTH AND DEPTH
H.360 L.1500 P.310 - H.360 W.1500 D.310

CODICE ARTICOLO E7731151
ITEM NUMBER

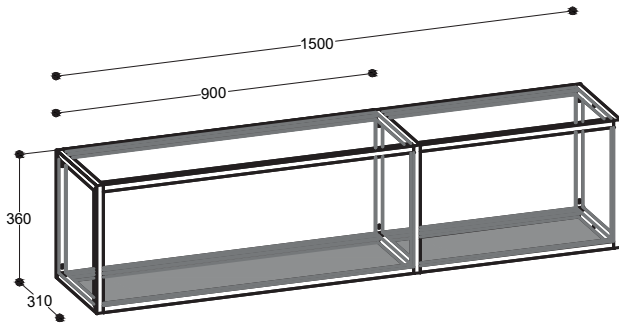

VERSO DX
TO THE RIGHT

FINITURA FINISH	A/V*	OPZIONE COLORE COLOUR OPTION
Nero Black	A	AL11
Titanio Titanium	A	AL12
Selce Flint Grey	V	AL13
Silver Dark Dark Silver	V	AL14
Oro Rosa Pink Gold	V	AL17
Rame Copper	V	AL23
Ottone Brass	V	AL24
Umber Umber	V	AL26

ALTEZZA, LARGHEZZA E PROFONDITA'

HEIGHT, WIDTH AND DEPTH
H.360 L.1500 P.310 - H.360 W.1500 D.310

CODICE ARTICOLO E7731152
ITEM NUMBER

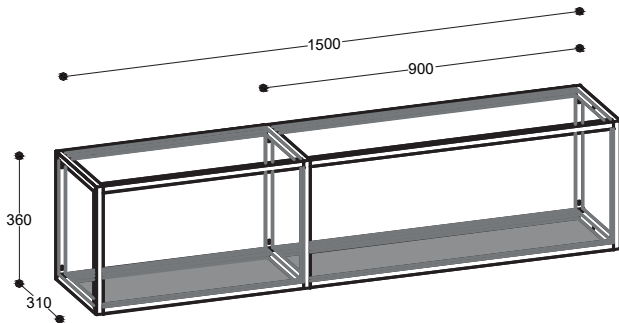

VERSO SX
TO THE LEFT

FINITURA FINISH	A/V*	OPZIONE COLORE COLOUR OPTION
Nero Black	A	AL11
Titanio Titanium	A	AL12
Selce Flint Grey	V	AL13
Silver Dark Dark Silver	V	AL14
Oro Rosa Pink Gold	V	AL17
Rame Copper	V	AL23
Ottone Brass	V	AL24
Umber Umber	V	AL26

FINITURE PER RIPIANI VETRO
FINISHES FOR GLASS SHELVES

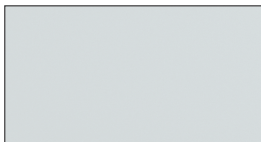

VETRO TRASPARENTE
TRANSPARENT GLASS



VETRO FUME' TRASPARENTE
TRANSPARENT SMOKED GLASS



VETRO BRONZO TRASPARENTE
TRANSPARENT BRONZE GLASS

Elementi terminali a giorno con schiena alluminio e ripiano vetro

Open end units with aluminum back panel and glass shelf

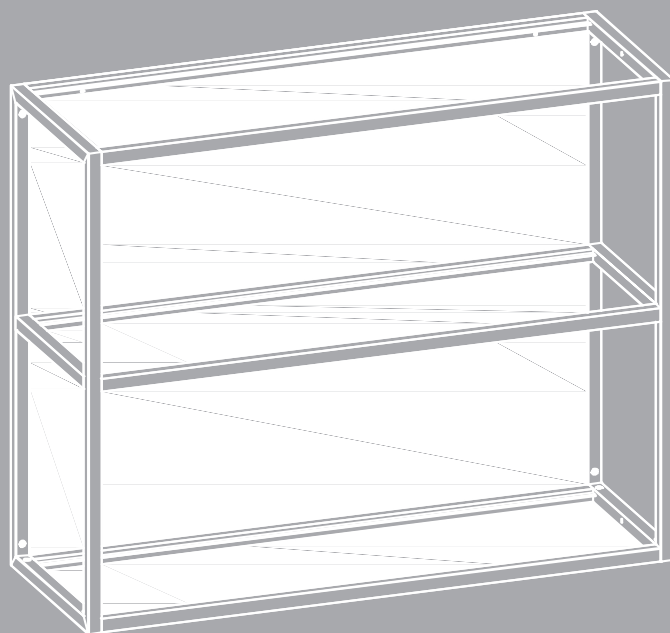

Terminali H 720
End Units

*A/V: A=ANODIZZATO V=VERNICIATO
ANODIZED PAINTED

CON SCHIENALE E FONDO
WITH BACK PANEL AND BOTTOM

ALTEZZA, LARGHEZZA E PROFONDITA'
HEIGHT, WIDTH AND DEPTH
H.720 L.575 P.310 - H.720 W.575 D.310

CODICE ARTICOLO E7812575
ITEM NUMBER

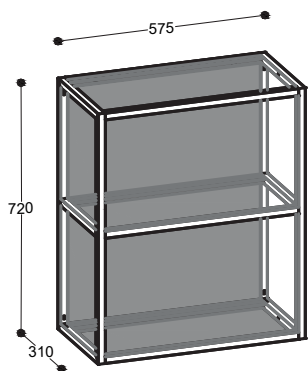

FINITURA FINISH	A/V*	OPZIONE COLORE COLOUR OPTION
■ Nero Black	A	AL11
■ Titanio Titanium	A	AL12
■ Selce Flint Grey	V	AL13
■ Silver Dark Dark Silver	V	AL14
■ Oro Rosa Pink Gold	V	AL17
■ Rame Copper	V	AL23
■ Ottone Brass	V	AL24
■ Umber Umber	V	AL26

ALTEZZA, LARGHEZZA E PROFONDITA'
HEIGHT, WIDTH AND DEPTH
H.720 L.885 P.310 - H.720 W.885 D.310

CODICE ARTICOLO E7812885
ITEM NUMBER

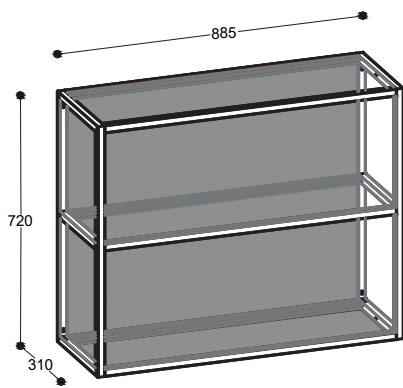

FINITURA FINISH	A/V*	OPZIONE COLORE COLOUR OPTION
■ Nero Black	A	AL11
■ Titanio Titanium	A	AL12
■ Selce Flint Grey	V	AL13
■ Silver Dark Dark Silver	V	AL14
■ Oro Rosa Pink Gold	V	AL17
■ Rame Copper	V	AL23
■ Ottone Brass	V	AL24
■ Umber Umber	V	AL26

FINITURE PER RIPIANI VETRO
FINISHES FOR GLASS SHELVES

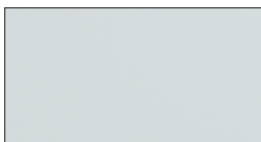

VETRO TRASPARENTE
TRANSPARENT GLASS



VETRO FUME' TRASPARENTE
TRANSPARENT SMOKED GLASS



VETRO BRONZO TRASPARENTE
TRANSPARENT BRONZE GLASS

Terminali H 750

End Units

***A/V:** A=ANODIZZATO V=VERNICIATO
ANODIZED PAINTED

CON SCHIENALE E FONDO
WITH BACK PANEL AND BOTTOM

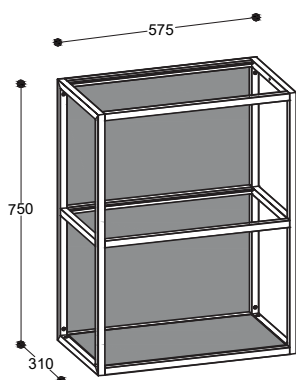

ALTEZZA, LARGHEZZA E PROFONDITA'
HEIGHT, WIDTH AND DEPTH
H.750 L.575 P.310 - H.750 W.575 D.310

CODICE ARTICOLO E7813575
ITEM NUMBER

FINITURA FINISH	A/V*	OPZIONE COLORE COLOUR OPTION
■ Nero Black	A	AL11
■ Titanio Titanium	A	AL12
■ Selce Flint Grey	V	AL13
■ Silver Dark Dark Silver	V	AL14
■ Oro Rosa Pink Gold	V	AL17
■ Rame Copper	V	AL23
■ Ottone Brass	V	AL24
■ Umber Umber	V	AL26

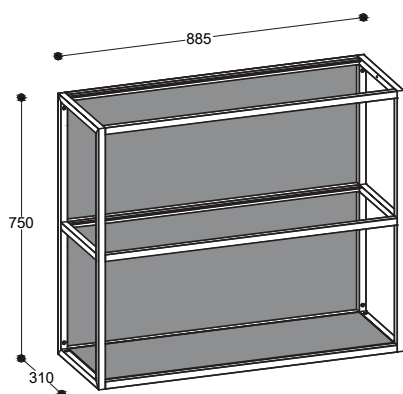

ALTEZZA, LARGHEZZA E PROFONDITA'
HEIGHT, WIDTH AND DEPTH
H.750 L.885 P.310 - H.750 W.885 D.310

CODICE ARTICOLO E7813885
ITEM NUMBER

FINITURA FINISH	A/V*	OPZIONE COLORE COLOUR OPTION
■ Nero Black	A	AL11
■ Titanio Titanium	A	AL12
■ Selce Flint Grey	V	AL13
■ Silver Dark Dark Silver	V	AL14
■ Oro Rosa Pink Gold	V	AL17
■ Rame Copper	V	AL23
■ Ottone Brass	V	AL24
■ Umber Umber	V	AL26

Terminali H 840

End Units

*A/V: A=ANODIZZATO V=VERNICIATO
ANODIZED PAINTED

CON SCHIENALE E FONDO
WITH BACK PANEL AND BOTTOM

ALTEZZA, LARGHEZZA E PROFONDITA'
HEIGHT, WIDTH AND DEPTH
H.840 L.885 P.310 - H.840 W.885 D.310

CODICE ARTICOLO E7815575
ITEM NUMBER

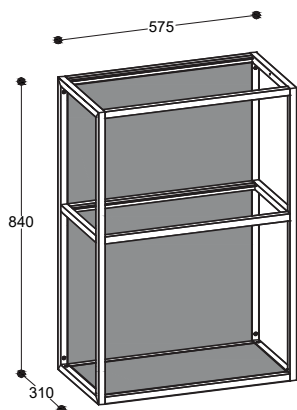

FINITURA FINISH	A/V*	OPZIONE COLORE COLOUR OPTION
■ Nero Black	A	AL11
■ Titanio Titanium	A	AL12
■ Selce Flint Grey	V	AL13
■ Silver Dark Dark Silver	V	AL14
■ Oro Rosa Pink Gold	V	AL17
■ Rame Copper	V	AL23
■ Ottone Brass	V	AL24
■ Umber Umber	V	AL26

ALTEZZA, LARGHEZZA E PROFONDITA'
HEIGHT, WIDTH AND DEPTH
H.840 L.885 P.310 - H.840 W.885 D.310

CODICE ARTICOLO E7815885
ITEM NUMBER

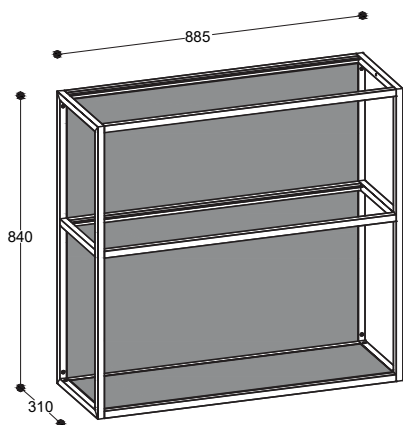

FINITURA FINISH	A/V*	OPZIONE COLORE COLOUR OPTION
■ Nero Black	A	AL11
■ Titanio Titanium	A	AL12
■ Selce Flint Grey	V	AL13
■ Silver Dark Dark Silver	V	AL14
■ Oro Rosa Pink Gold	V	AL17
■ Rame Copper	V	AL23
■ Ottone Brass	V	AL24
■ Umber Umber	V	AL26

FINITURE PER RIPIANI VETRO

FINISHES FOR GLASS SHELVES

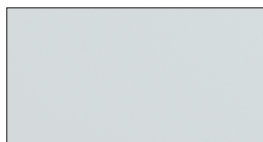

VETRO TRASPARENTE
TRANSPARENT GLASS



VETRO FUME' TRASPARENTE
TRANSPARENT SMOKED GLASS



VETRO BRONZO TRASPARENTE
TRANSPARENT BRONZE GLASS

Elementi terminali a giorno con schiena personalizzata e ripiano vetro

Open end units with personalized back panel and glass shelf

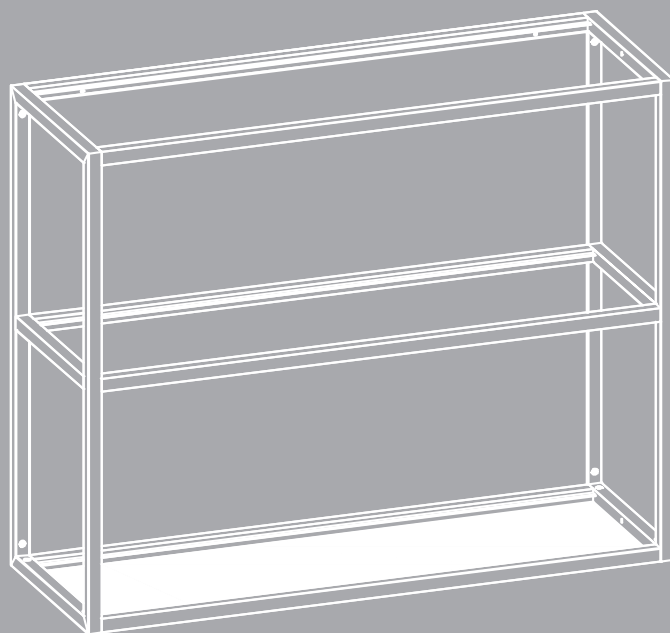

Terminali H 720

End Units

***A/V:** **A**=ANODIZZATO **V**=VERNICIATO
ANODIZED PAINTED

N.B.: PER I COLORI DELLE SCHIENE VEDI PAG:74-77
NOTE: FOR THE BACK PANEL COLORS SEE PAGE 74-77

ALTEZZA, LARGHEZZA E PROFONDITA'

HEIGHT, WIDTH AND DEPTH

H.720 L.575 P.310 - H.720 W.575 D.310

CODICE ARTICOLO E7762575
ITEM NUMBER

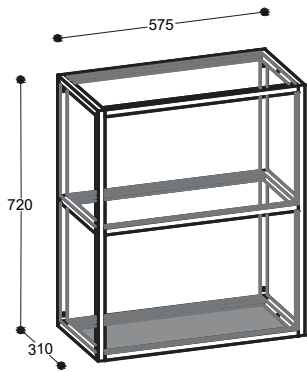

FINITURA FINISH	A/V*	OPZIONE COLORE COLOUR OPTION
■ Nero Black	A	AL11
■ Titanio Titanium	A	AL12
■ Selce Flint Grey	V	AL13
■ Silver Dark Dark Silver	V	AL14
■ Oro Rosa Pink Gold	V	AL17
■ Rame Copper	V	AL23
■ Ottone Brass	V	AL24
■ Umber Umber	V	AL26

Terminali H 720

End Units

*A/V: A=ANODIZZATO V=VERNICIATO
ANODIZED PAINTED

N.B.: PER I COLORI DELLE SCHIENE VEDI PAG:74-77
NOTE: FOR THE BACK PANEL COLORS SEE PAGE 74-77

ALTEZZA, LARGHEZZA E PROFONDITA'

HEIGHT, WIDTH AND DEPTH

H.720 L.885 P.310 - H.720 W.885 D.310

CODICE ARTICOLO E7762885

ITEM NUMBER

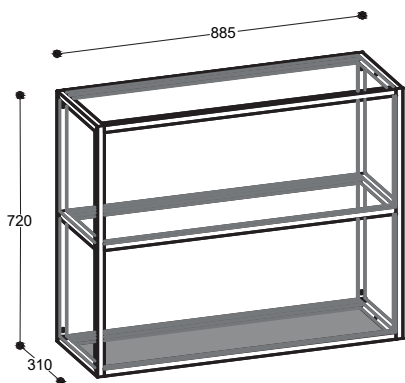

FINITURA FINISH	A/V*	OPZIONE COLORE COLOUR OPTION
Nero Black	A	AL11
Titanio Titanium	A	AL12
Selce Flint Grey	V	AL13
Silver Dark Dark Silver	V	AL14
Oro Rosa Pink Gold	V	AL17
Rame Copper	V	AL23
Ottone Brass	V	AL24
Umber Umber	V	AL26

FINITURE PER RIPIANI VETRO

FINISHES FOR GLASS SHELVES

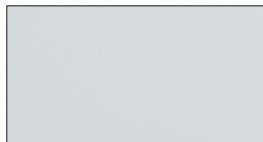

VETRO TRASPARENTE
TRANSPARENT GLASS



VETRO FUME' TRASPARENTE
TRANSPARENT SMOKED GLASS

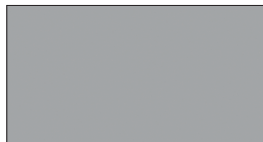

VETRO BRONZO TRASPARENTE
TRANSPARENT BRONZE GLASS

Terminali H 750

End Units

*A/V: A=ANODIZZATO V=VERNICIATO
ANODIZED PAINTED

N.B.: PER I COLORI DELLE SCHIENE VEDI PAG:74-77
NOTE: FOR THE BACK PANEL COLORS SEE PAGE 74-77

ALTEZZA, LARGHEZZA E PROFONDITA'

HEIGHT, WIDTH AND DEPTH

H.750 L.575 P.310 - H.750 W.575 D.310

CODICE ARTICOLO E7763575

ITEM NUMBER

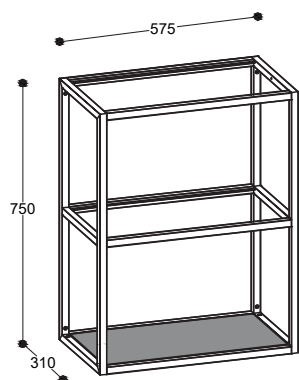

FINITURA FINISH	A/V*	OPZIONE COLORE COLOUR OPTION
■ Nero Black	A	AL11
■ Titanio Titanium	A	AL12
■ Selce Flint Grey	V	AL13
■ Silver Dark Dark Silver	V	AL14
■ Oro Rosa Pink Gold	V	AL17
■ Rame Copper	V	AL23
■ Ottone Brass	V	AL24
■ Umber Umber	V	AL26

ALTEZZA, LARGHEZZA E PROFONDITA'

HEIGHT, WIDTH AND DEPTH

H.750 L.885 P.310 - H.750 W.885 D.310

CODICE ARTICOLO E7763885

ITEM NUMBER

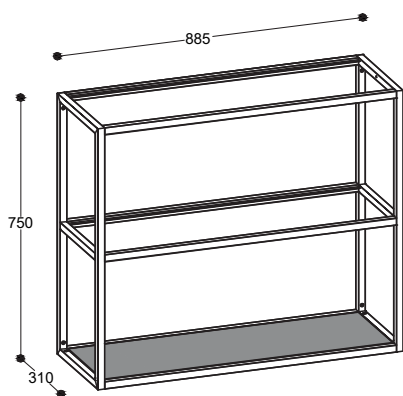

FINITURA FINISH	A/V*	OPZIONE COLORE COLOUR OPTION
■ Nero Black	A	AL11
■ Titanio Titanium	A	AL12
■ Selce Flint Grey	V	AL13
■ Silver Dark Dark Silver	V	AL14
■ Oro Rosa Pink Gold	V	AL17
■ Rame Copper	V	AL23
■ Ottone Brass	V	AL24
■ Umber Umber	V	AL26

Terminali H 840

End Units

*A/V: A=ANODIZZATO V=VERNICIATO
ANODIZED PAINTED

N.B.: PER I COLORI DELLE SCHIENE VEDI PAG:74-77
NOTE: FOR THE BACK PANEL COLORS SEE PAGE 74-77

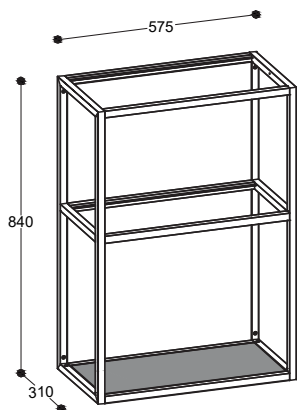

ALTEZZA, LARGHEZZA E PROFONDITA'

HEIGHT, WIDTH AND DEPTH

H.840 L.575 P.310 - H.840 W.575 D.310

CODICE ARTICOLO E7765575

ITEM NUMBER

FINITURA FINISH	A/V*	OPZIONE COLORE COLOUR OPTION
■ Nero Black	A	AL11
■ Titanio Titanium	A	AL12
■ Selce Flint Grey	V	AL13
■ Silver Dark Dark Silver	V	AL14
■ Oro Rosa Pink Gold	V	AL17
■ Rame Copper	V	AL23
■ Ottone Brass	V	AL24
■ Umber Umber	V	AL26

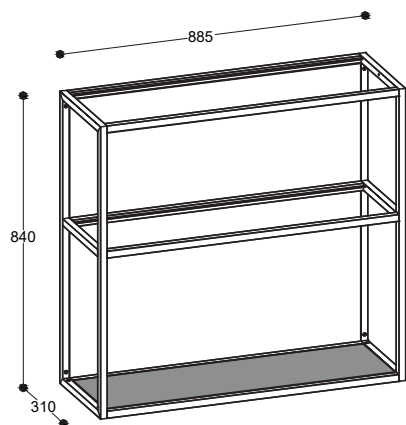

ALTEZZA, LARGHEZZA E PROFONDITA'

HEIGHT, WIDTH AND DEPTH

H.840 L.885 P.31 - H.840 W.885 D.310

CODICE ARTICOLO E7765885

ITEM NUMBER

FINITURA FINISH	A/V*	OPZIONE COLORE COLOUR OPTION
■ Nero Black	A	AL11
■ Titanio Titanium	A	AL12
■ Selce Flint Grey	V	AL13
■ Silver Dark Dark Silver	V	AL14
■ Oro Rosa Pink Gold	V	AL17
■ Rame Copper	V	AL23
■ Ottone Brass	V	AL24
■ Umber Umber	V	AL26

Nero AL11
Anodizzato



Selce AL13
Verniciato

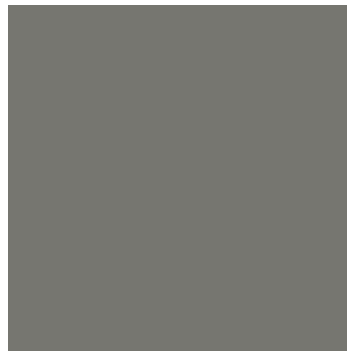

Titanio AL12
Anodizzato

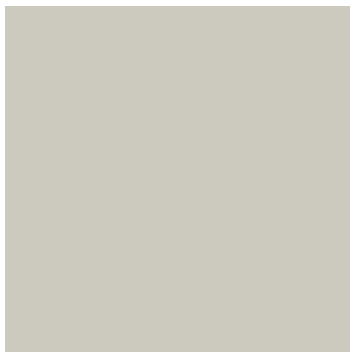

Silver Dark AL14
Verniciato



Oro Rosa AL17
Verniciato

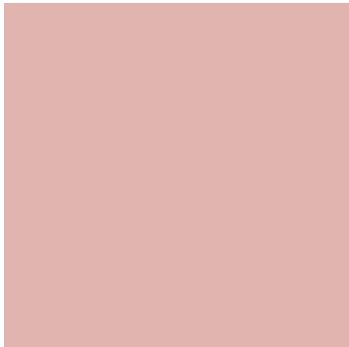

Ottone AL24
Verniciato



Rame AL23
Verniciato



Umber AL26
Verniciato



COLORI IMPIALLACCIATI MODELLO OLTRE FASCIA C
OLTRE MODEL VENEERED COLOURS BAND C



COLORI IMPIALLACCIATI MODELLO CLOVER FASCIA C
CLOVER MODEL VENEERED COLOURS BAND C



COLORI IMPIALLACCIATI MODELLO LUNA FASCIA C
LUNA MODEL VENEERED COLOURS **BAND C**



COLORI IMPIALLACCIATI MODELLO IMMAGINA WOOD FASCIA B
IMMAGINA WOOD MODEL VENEERED COLOURS **BAND B**



COLORI IMPIALLACCIATI MODELLO FLAVOUR FASCIA C
FLAVOUR MODEL VENEERED COLOURS **BAND C**

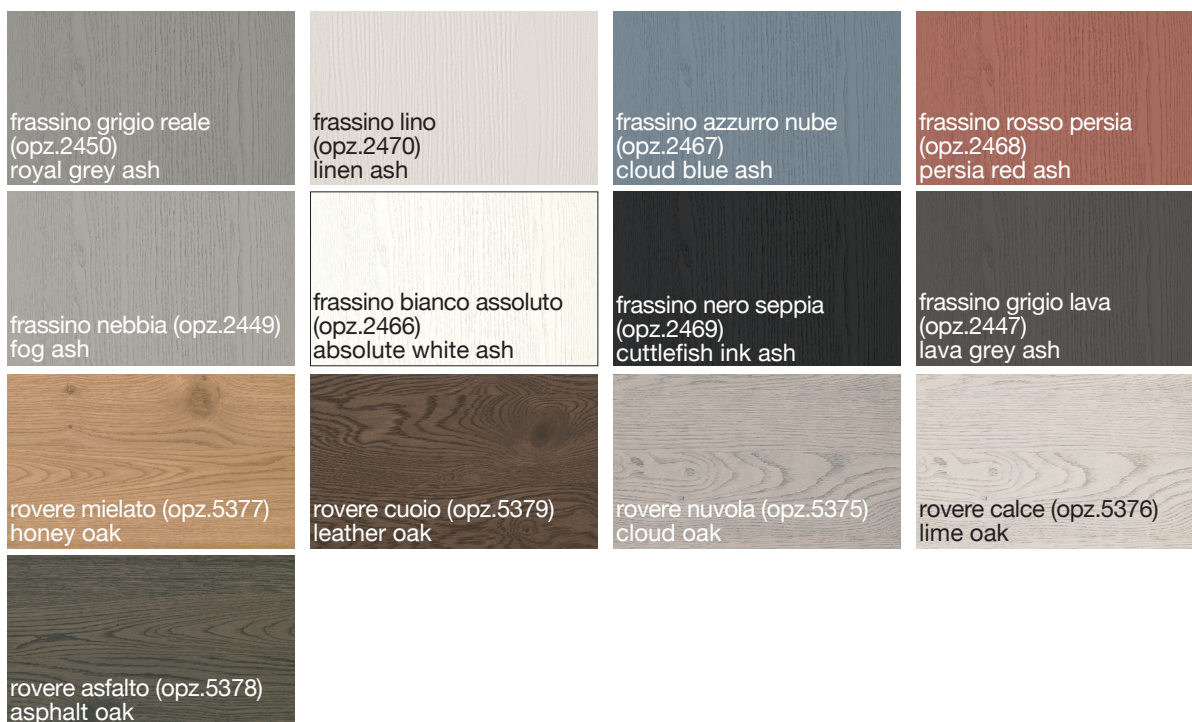

COLORI FRASSINO MODELLO VERONICA FASCIA C
VERONICA MODEL ASH COLOURS BAND C



COLORI FRASSINO MODELLO CONTEMPO FASCIA C
CONTEMPOMODEL ASH COLOURS BAND C



COLORI EFFETTO MARMO FASCIA A
COLOURS MARBLE EFFECT BAND A

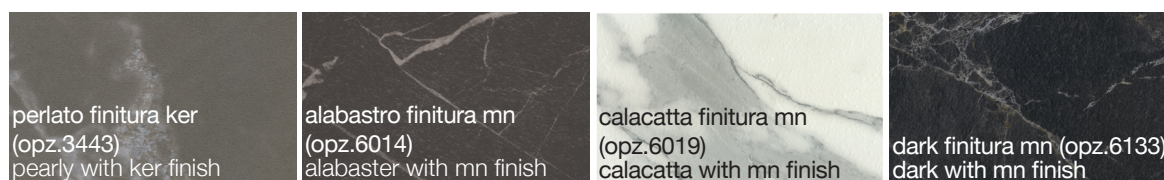

COLORI LACCATI UV FASCIA A
UV LACQUERED COLOURS BAND A

 bianco (opz.7405) white	 antracite (opz.9558) anthracite	 grigio arena (opz.9521) arena grey	 rosso vino (opz.8163) wine red
 bianco neve (opz.7407) snow white	 verde malga (opz.8477) alpine green	 ardesia (opz.9525) slate grey	 nero (opz.7895) black
 desert (opz.8941) desert	 polvere (opz.9529) dust	 cannella (opz.8891) cinnamon	 blu cobalto (opz.8383) cobalt blue

Modularità e componibilità per zoccolo H 13

MODULARITY AND FITTING SOLUTIONS FOR PLINTH H 13

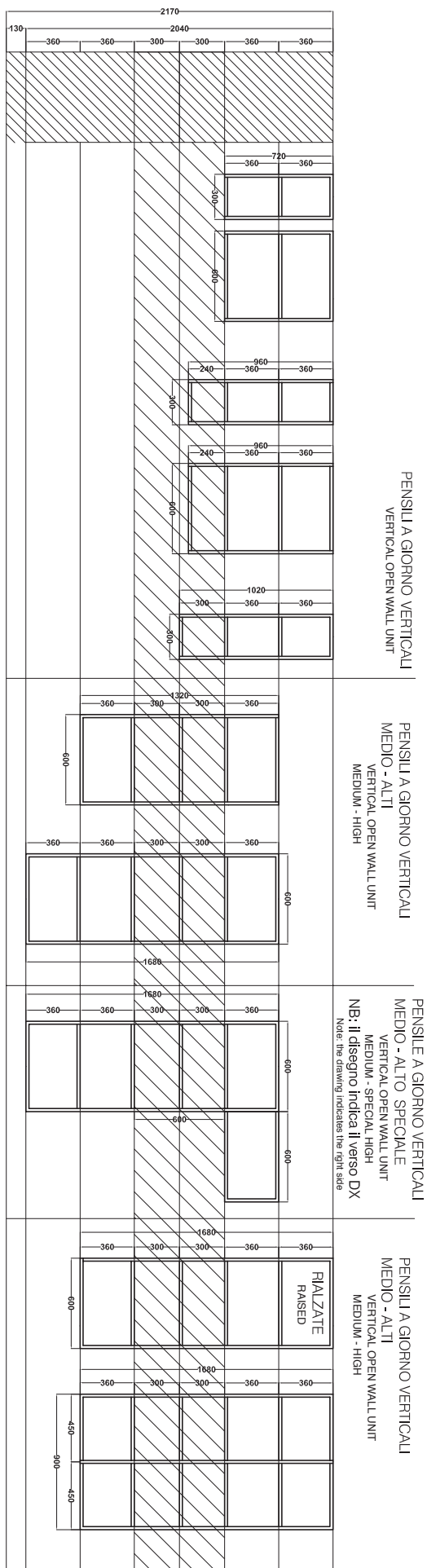

COLONNE A GIORNO RIALZATE
OPEN COLUMNS RAISED

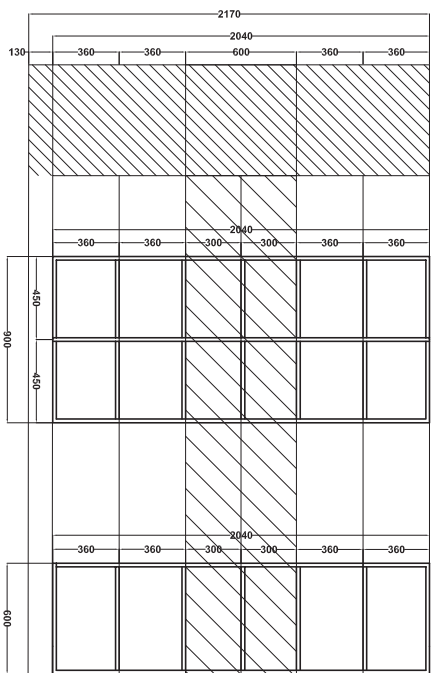

ELEMENTI A GIORNO TERMINALI PER BASE,
con schienale e fondo predisposto per piedini
OPEN ELEMENTS FOR BASE UNITS
with back panel and bottom arranged for feet

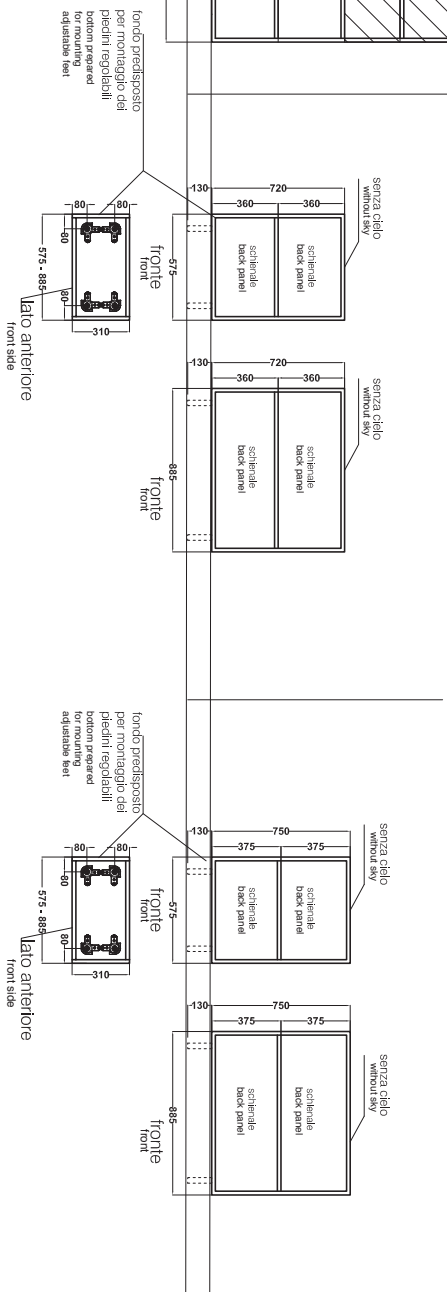

Modularità e Componibilità per zoccolo H 6

MODULARITY AND FITTING SOLUTIONS FOR PLINTH H 6

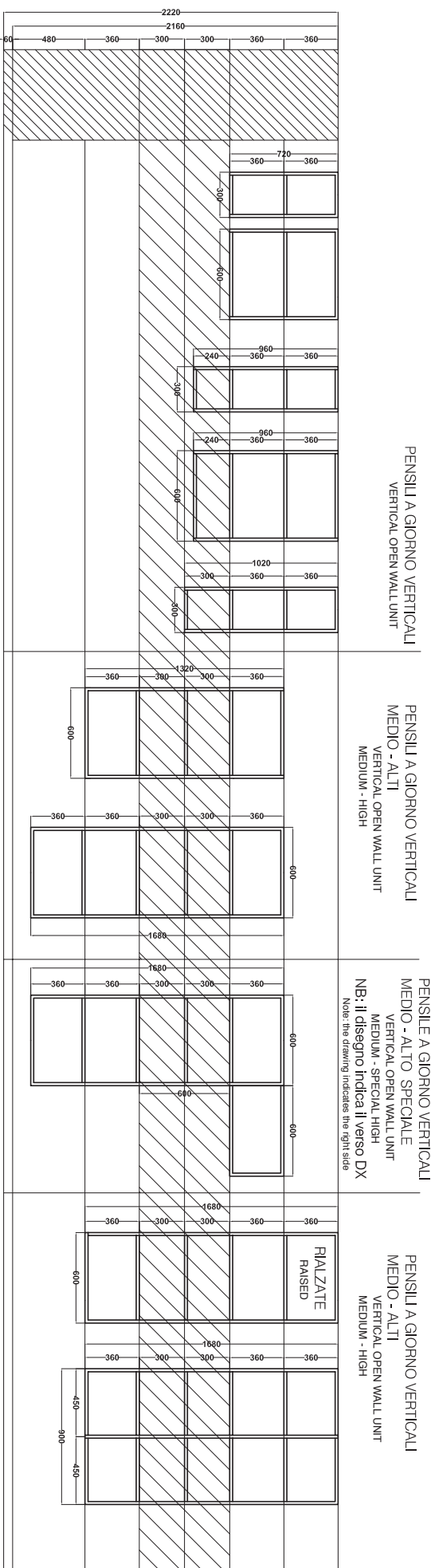

COLONNE A GIORNO RIALZATE

OPEN COLUMNS RAISED

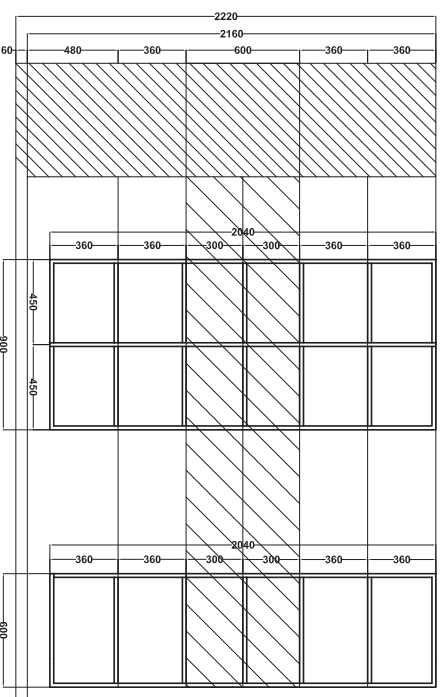

ELEMENTI A GIORNO TERMINALI PER BASE, con schienale e fondo predisposto per piedini

OPEN ELEMENTS FOR BASE UNITS with back panel and bottom arranged for feet

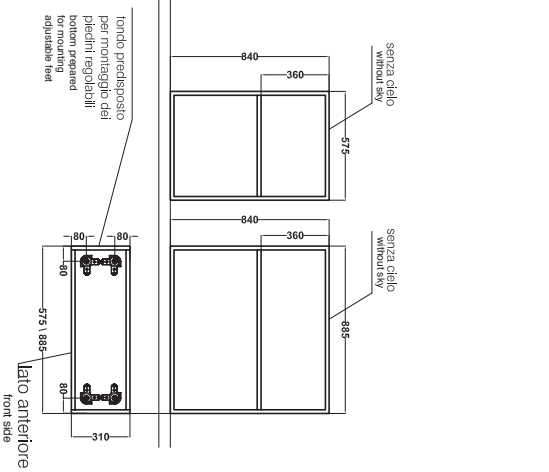

CUCINE
LUBE

GRUPPO LUBE

CREO
KITCHENS

Boiserie Cover



BOISERIE COVER IN APPOGGIO

COVER BOISERIE ON SUPPORT

**Modulo cm 45-60-65-90 P 1,8
per pensile H 72**

**N.B.: disponibilità kit
ferramenta per bloccaggio
pannello telescopico
vedi pag.30**

Rack element
cm 45-60-65-90 D 1,8
for wall unit H 72

Note: availability of hardware
kit for locking telescopic
panel see page 30

**CODICE
CODE No.**

DESERT

**STONE
GREY**

**SILVER
DARK**

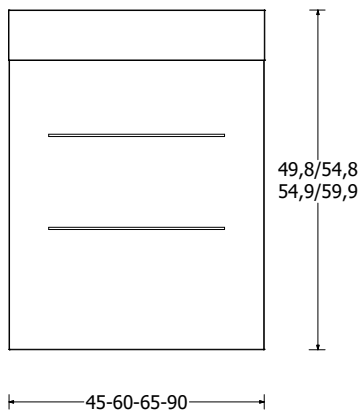

FIANCO H 72/H 84

L 45 da 54,9 a 59,9
L 60 da 54,9 a 59,9
L 65 da 54,9 a 59,9
L 90 da 54,9 a 59,9

SIDE H 72/H 84

W 45 from 54.9 to 59.9
W 60 from 54.9 to 59.9
W 65 from 54.9 to 59.9
W 90 from 54.9 to 59.9

086SH45055
086SH60055
086SH65055
086SH90055

FIANCO H 75

per altezza top maggiore e uguale a 24 mm

L 45 da 49,8 a 54,8
L 60 da 49,8 a 54,8
L 65 da 49,8 a 54,8
L 90 da 49,8 a 54,8

SIDE H 75

for greater top height and equal to 24 mm

W 45 from 49,8 to 54,8
W 60 from 49,8 to 54,8
W 65 from 49,8 to 54,8
W 90 from 49,8 to 54,8

086SH45045
086SH60045
086SH65045
086SH90045

per altezza top minore a 24 mm

L 45 da 54,9 a 59,9
L 60 da 54,9 a 59,9
L 65 da 54,9 a 59,9
L 90 da 54,9 a 59,9

for lesser top height to 24 mm

W 45 from 54.9 to 59.9
W 60 from 54.9 to 59.9
W 65 from 54.9 to 59.9
W 90 from 54.9 to 59.9

086SH45055
086SH60055
086SH65055
086SH90055

Finiture "BOISERIE"

"BOISERIE" finishes

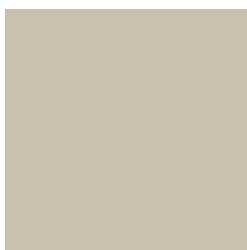

Desert (opz.D)

Desert

**N.B.: riferimento immagine
(opz.8941) UV**

Note: reference immagine
(opt.8941) UV



Stone Grey (opz.G)

Grey Stone

**N.B.: riferimento immagine
melaminico (opz.9650)**

Note: reference immagine
melamine (opt.9650)



Silver Dark (opz.S)

Dark Silver

BOISERIE COVER IN APPOGGIO

COVER BOISERIE ON SUPPORT

**Modulo cm 45-60-65-90 P 1,8
per pensile H 60**

**N.B.: disponibilità kit
ferramenta per bloccaggio
pannello telescopico
vedi pag.30**

Rack element
cm 45-60-65-90 D 1,8
for wall unit H 60

Note: availability of hardware
kit for locking telescopic
panel see page 30

**CODICE
CODE No.**

DESERT

**STONE
GREY**

**SILVER
DARK**

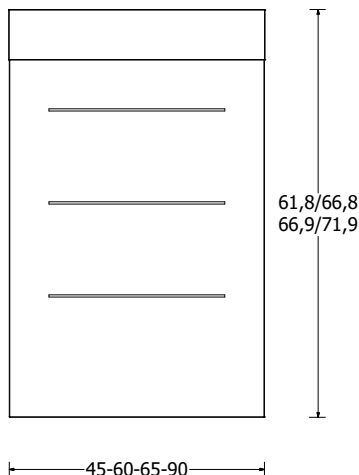

FIANCO H 72/H 84

L 45 da 66,9 a 71,9
L 60 da 66,9 a 71,9
L 65 da 66,9 a 71,9
L 90 da 66,9 a 71,9

SIDE H 72/H 84

W 45 from 66.9 to 71.9
W 60 from 66.9 to 71.9
W 65 from 66.9 to 71.9
W 90 from 66.9 to 71.9

086SH45067
086SH60067
086SH65067
086SH90067

FIANCO H 75

per altezza top maggiore e uguale a 24 mm

L 45 da 61,8 a 66,8
L 60 da 61,8 a 66,8
L 65 da 61,8 a 66,8
L 90 da 61,8 a 66,8

SIDE H 75

for greater top height and equal to 24 mm

W 45 from 61,8 to 66,8
W 60 from 61,8 to 66,8
W 65 from 61,8 to 66,8
W 90 from 61,8 to 66,8

086SH45066
086SH60066
086SH65066
086SH90066

per altezza top minore a 24 mm

L 45 da 66,9 a 71,9
L 60 da 66,9 a 71,9
L 65 da 66,9 a 71,9
L 90 da 66,9 a 71,9

for lesser top height to 24 mm

W 45 from 66.9 to 71.9
W 60 from 66.9 to 71.9
W 65 from 66.9 to 71.9
W 90 from 66.9 to 71.9

086SH45067
086SH60067
086SH65067
086SH90067

Finiture "BOISERIE"

"BOISERIE" finishes

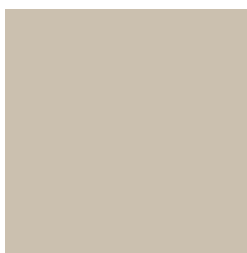

Desert (opz.D)

Desert

**N.B.: riferimento immagine
(opz.8941) UV**

Note: reference immagine
(opt.8941) UV

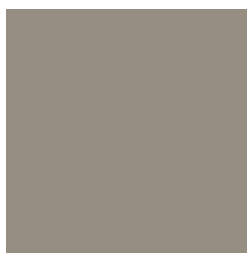

Stone Grey (opz.G)

Grey Stone

**N.B.: riferimento immagine
melaminico (opz.9650)**

Note: reference immagine
melamine (opt.9650)



Silver Dark (opz.S)

Dark Silver

BOISERIE COVER IN APPOGGIO

COVER BOISERIE ON SUPPORT

Modulo cm 45-60-65-90 P 1,8
per pensile H 48

**N.B.: disponibilità kit
ferramenta per bloccaggio
pannello telescopico
vedi pag.30**

Rack element
cm 45-60-65-90 D 1,8
for wall unit H 48

Note: availability of hardware
kit for locking telescopic
panel see page 30

CODICE
CODE No.

DESERT

**STONE
GREY**

**SILVER
DARK**

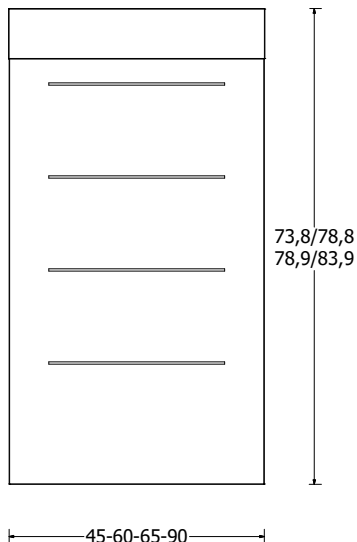

FIANCO H 72/H 84

L 45 da 78,9 a 83,9
L 60 da 78,9 a 83,9
L 65 da 78,9 a 83,9
L 90 da 78,9 a 83,9

SIDE H 72/H 84

W 45 from 78.9 to 83.9
W 60 from 78.9 to 83.9
W 65 from 78.9 to 83.9
W 90 from 78.9 to 83.9

086SH45079
086SH60079
086SH65079
086SH90079

FIANCO H 75

per altezza top maggiore e uguale a 24 mm

L 45 da 73,8 a 78,8
L 60 da 73,8 a 78,8
L 65 da 73,8 a 78,8
L 90 da 73,8 a 78,8

SIDE H 75

for greater top height and equal to 24 mm

W 45 from 73,8 to 78,8
W 60 from 73,8 to 78,8
W 65 from 73,8 to 78,8
W 90 from 73,8 to 78,8

086SH45077
086SH60077
086SH65077
086SH90077

per altezza top minore a 24 mm

L 45 da 78,9 a 83,9
L 60 da 78,9 a 83,9
L 65 da 78,9 a 83,9
L 90 da 78,9 a 83,9

for lesser top height to 24 mm

W 45 from 78.9 to 83.9
W 60 from 78.9 to 83.9
W 65 from 78.9 to 83.9
W 90 from 78.9 to 83.9

086SH45079
086SH60079
086SH65079
086SH90079

Finiture "BOISERIE"

"BOISERIE" finishes



Desert (opz.D)

Desert

**N.B.: riferimento immagine
(opz.8941) UV**

Note: reference immagine
(opt.8941) UV

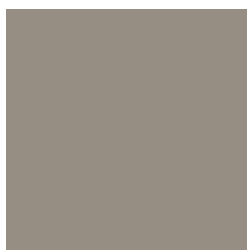

Stone Grey (opz.G)

Grey Stone

**N.B.: riferimento immagine
melaminico (opz.9650)**

Note: reference immagine
melamine (opt.9650)



Silver Dark (opz.S)

Dark Silver

BOISERIE COVER IN APPOGGIO

COVER BOISERIE ON SUPPORT

**Modulo cm 45-60-65-90 P 1,8
per pensile H 36**

**N.B.: disponibilità kit
ferramenta per bloccaggio
pannello telescopico
vedi pag.30**

Rack element
cm 45-60-65-90 D 1,8
for wall unit H 36

Note: availability of hardware
kit for locking telescopic
panel see page 30

**CODICE
CODE No.**

DESERT

**STONE
GREY**

**SILVER
DARK**

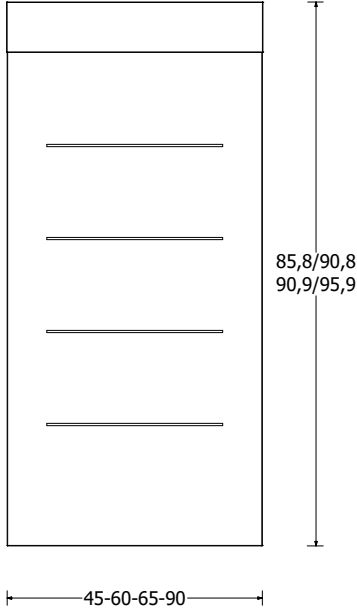

FIANCO H 72/H 84

L 45 da 90,9 a 95,9
L 60 da 90,9 a 95,9
L 65 da 90,9 a 95,9
L 90 da 90,9 a 95,9

SIDE H 72/H 84

W 45 from 90.9 to 95.9
W 60 from 90.9 to 95.9
W 65 from 90.9 to 95.9
W 90 from 90.9 to 95.9

086SH45091
086SH60091
086SH65091
086SH90091

FIANCO H 75

per altezza top maggiore e uguale a 24 mm

L 45 da 85,8 a 90,8
L 60 da 85,8 a 90,8
L 65 da 85,8 a 90,8
L 90 da 85,8 a 90,8

SIDE H 75

for greater top height and equal to 24 mm

W 45 from 85,8 to 90,8
W 60 from 85,8 to 90,8
W 65 from 85,8 to 90,8
W 90 from 85,8 to 90,8

086SH45089
086SH60089
086SH65089
086SH90089

per altezza top minore a 24 mm

L 45 da 90,9 a 95,9
L 60 da 90,9 a 95,9
L 65 da 90,9 a 95,9
L 90 da 90,9 a 95,9

for lesser top height to 24 mm

W 45 from 90.9 to 95.9
W 60 from 90.9 to 95.9
W 65 from 90.9 to 95.9
W 90 from 90.9 to 95.9

086SH45091
086SH60091
086SH65091
086SH90091

Finiture "BOISERIE"

"BOISERIE" finishes



Desert (opz.D)

Desert

**N.B.: riferimento immagine
(opz.8941) UV**

Note: reference immagine
(opt.8941) UV

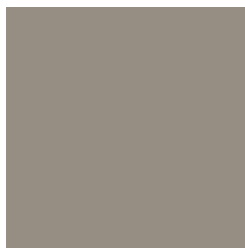

Stone Grey (opz.G)

Grey Stone

**N.B.: riferimento immagine
melaminico (opz.9650)**

Note: reference immagine
melamine (opt.9650)

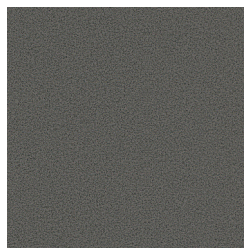

Silver Dark (opz.S)

Dark Silver

BOISERIE COVER IN APPOGGIO

COVER BOISERIE ON SUPPORT

Modulo cm 45-60-65-90 P 1,8

Rack element
cm 45-60-65-90 D 1,8

N.B.: se utilizzato senza
sopracolonna disponibilità
kit ferramenta per bloccaggio
pannello telescopico
vedi pag.30

Note: if used without column
availability of hardware
kit for locking telescopic
panel see page 30

CODICE
CODE No.

DESERT

STONE
GREY

SILVER
DARK

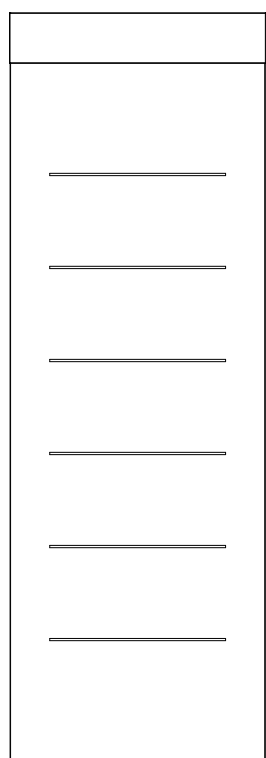

121,8/126,8
126,9/131,9

45-60-65-90

FIANCO H 72/H 84

L 45 da 126,9 a 131,9
L 60 da 126,9 a 131,9
L 65 da 126,9 a 131,9
L 90 da 126,9 a 131,9

SIDE H 72/H 84

W 45 from 126.9 to 131.9
W 60 from 126.9 to 131.9
W 65 from 126.9 to 131.9
W 90 from 126.9 to 131.9

086SH45123
086SH60123
086SH65123
086SH90123

FIANCO H 75

per altezza top maggiore e uguale a 24 mm

L 45 da 121,8 a 126,8
L 60 da 121,8 a 126,8
L 65 da 121,8 a 126,8
L 90 da 121,8 a 126,8

SIDE H 75

for greater top height and equal to 24 mm

W 45 from 121,8 to 126,8
W 60 from 121,8 to 126,8
W 65 from 121,8 to 126,8
W 90 from 121,8 to 126,8

086SH45122
086SH60122
086SH65122
086SH90122

per altezza top minore a 24 mm

L 45 da 126,9 a 131,9
L 60 da 126,9 a 131,9
L 65 da 126,9 a 131,9
L 90 da 126,9 a 131,9

for lesser top height to 24 mm

W 45 from 126.9 to 131.9
W 60 from 126.9 to 131.9
W 65 from 126.9 to 131.9
W 90 from 126.9 to 131.9

086SH45123
086SH60123
086SH65123
086SH90123

Finiture "BOISERIE"

"BOISERIE" finishes

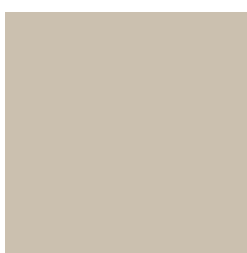

Desert (opz.D)

Desert

N.B.: riferimento immagine
(opz.8941) UV

Note: reference immagine
(opt.8941) UV



Stone Grey (opz.G)

Grey Stone

N.B.: riferimento immagine
melaminico (opz.9650)

Note: reference immagine
melamine (opt.9650)



Silver Dark (opz.S)

Dark Silver

BOISERIE COVER SOSPESA

COVER BOISERIE HANGING

Modulo cm 60
P 1,8 H 114

Rack element cm 60
D 1,8 H 114

CODICE
CODE No.

DESERT

**STONE
GREY**

**SILVER
DARK**

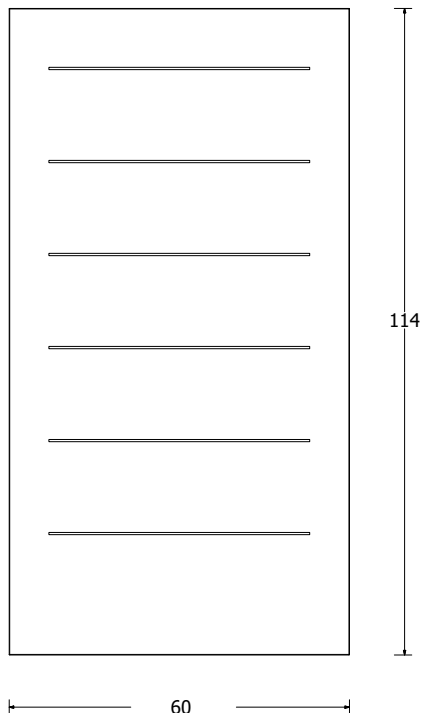

H 114
L 60

H 114
W 60

086SHS6011

Finiture "BOISERIE"

"BOISERIE" finishes



Desert (opz.D)

Desert

N.B.: riferimento immagine (opz.8941) UV

Note: reference immagine (opt.8941) UV

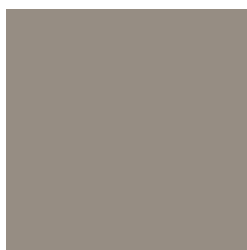

Stone Grey (opz.G)

Grey Stone

N.B.: riferimento immagine melaminico (opz.9650)

Note: reference immagine melamine (opt.9650)

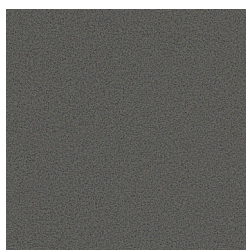

Silver Dark (opz.S)

Dark Silver

BOISERIE COVER SOSPESA

COVER BOISERIE HANGING

Modulo cm 60 P 1,8
per colonna

Rack element
cm 60 D 1,8 for column

CODICE
CODE No.

DESERT

**STONE
GREY**

**SILVER
DARK**

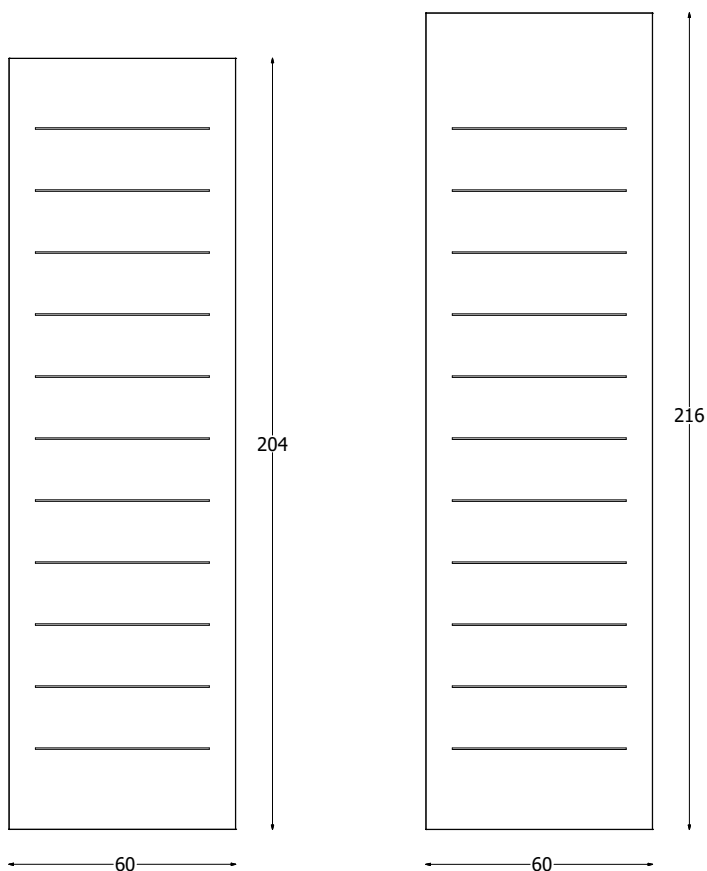

FIANCO H 204
L 60

SIDE H 204
W 60

086SHL6020

FIANCO H 216
L 60

SIDE H 216
W 60

086SHL6021

Finiture "BOISERIE"

"BOISERIE" finishes

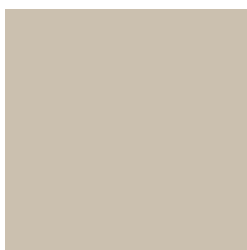

Desert (opz.D)

Desert

**N.B.: riferimento immagine
(opz.8941) UV**

Note: reference immagine
(opt.8941) UV

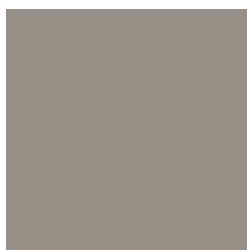

Stone Grey (opz.G)

Grey Stone

**N.B.: riferimento immagine
melaminico (opz.9650)**

Note: reference immagine
melamine (opt.9650)



Silver Dark (opz.S)

Dark Silver

TERMINALI COVER

COVER END UNITS

**Terminale isola/penisola H 72
zoccolo H 13**

**N.B.: possibilità di inserimento
luce sul cielo, per alimentatore
vedi listino luci L&S**

End unit
island/peninsula H 72
plinth H 13

Note: possibility
to insert light on
top, for the power
supply see L&S light
pricelist

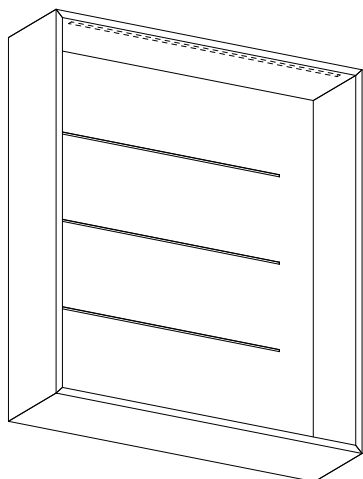

**N.B.: Schienale non rifinito, non progettare a sbalzo
rispetto alle basi**

Unfinished back panel, do not design cantilever
than the base unit

L 16,8 H 72 P 62,3
Luce 7,8W

W 16,8 H 72 D 62,3
Light 7,8W

086SHF56
08618325

CODICE
CODE No.

ROUND
PET

CLOVER
IMP.
FASCIA A

CLOVER
IMP.
FASCIA B

LUNA
IMP.
FASCIA A

LUNA
IMP.
FASCIA B

FLAVOUR
IMP.
FASCIA B

FLAVOUR
IMP.
FASCIA C

CLOVER
LUNA
FLAVOUR
LACCATO
OPACO

Finiture "BOISERIE"

"BOISERIE" finishes



Desert (opz.D)

Desert

**N.B.: riferimento immagine
(opz.8941) UV**

Note: reference immagine
(opt.8941) UV

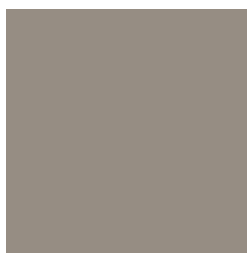

Stone Grey (opz.G)

Grey Stone

**N.B.: riferimento immagine
melaminico (opz.9650)**

Note: reference immagine
melamine (opt.9650)



Silver Dark (opz.S)

Dark Silver

TERMINALI COVER

COVER END UNITS

**Terminale isola/penisola H 75
zoccolo H 13**

End unit island/peninsula H 75 plinth H 13

**N.B.: possibilità di inserimento
luce sul cielo, per alimentatore
vedi listino luci L&S**

Note: possibility to insert light on top,
for the power supply see L&S light
pricelist

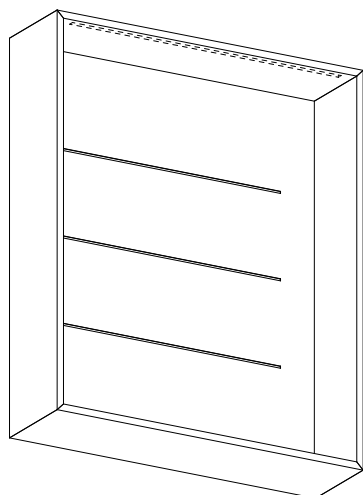

**N.B.: Schienale non rifinito, non progettare a sbalzo
rispetto alle basi**

Unfinished back panel, do not design cantilever
than the base unit

L 16,8 H 75 P 62,3
Luce 7,8W

W 16,8 H 75 D 62,3
Light 7,8W

086SHF58
08618325

CODICE
CODE No.

ROUND
PET

CLOVER
IMP.
FASCIA A

CLOVER
IMP.
FASCIA B

FLAVOUR
IMP.
FASCIA B

FLAVOUR
IMP.
FASCIA C

CLOVER
FLAVOUR
LACCATO
OPACO

Finiture "BOISERIE"

"BOISERIE" finishes

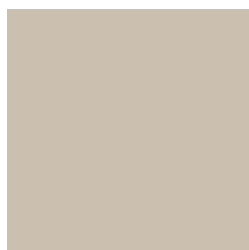

Desert (opz.D)

Desert

**N.B.: riferimento immagine
(opz.8941) UV**

Note: reference immagine
(opt.8941) UV

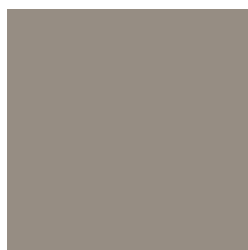

Stone Grey (opz.G)

Grey Stone

**N.B.: riferimento immagine
melaminico (opz.9650)**

Note: reference immagine
melamine (opt.9650)



Silver Dark (opz.S)

Dark Silver

TERMINALI COVER

COVER END UNITS

**Terminale isola/penisola H 84
zoccolo H 6**

End unit island/peninsula H 84 plinth H 6

**N.B.: possibilità di inserimento
luce sul cielo, per alimentatore
vedi listino luci L&S**

Note: possibility to insert light on top, for the
power supply see L&S light pricelist

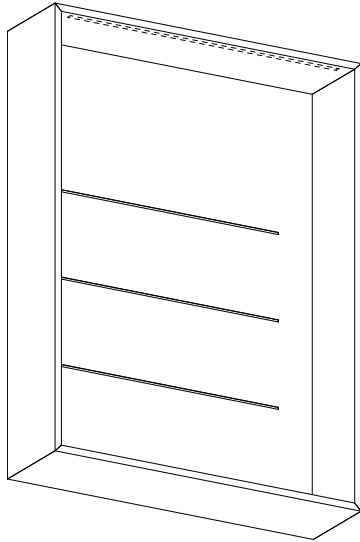

**N.B.: Schienale non rifinito, non progettare a sbalzo
rispetto alle basi**

Unfinished back panel, do not design cantilever
than the base unit

L 16,8 H 84 P 62,3
Luce 7,8W

W 16,8 H 84 D 62,3
Light 7,8W

086SHF66
08618325

CODICE
CODE No.

ROUND
PET

OLTRE
IMP.

FLAVOUR
IMP.
FASCIA B

FLAVOUR
IMP.
FASCIA C

OLTRE
FLAVOUR
LACCATO
OPACO

Finiture "BOISERIE"

"BOISERIE" finishes



Desert (opz.D)

Desert

**N.B.: riferimento immagine
(opz.8941) UV**

Note: reference immagine
(opt.8941) UV



Stone Grey (opz.G)

Grey Stone

**N.B.: riferimento immagine
melaminico (opz.9650)**

Note: reference immagine
melamine (opt.9650)

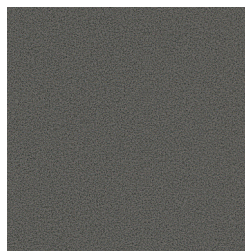

Silver Dark (opz.S)

Dark Silver

TERMINALI COVER

COVER END UNITS

Terminale isola H 72
zoccolo H 13

End unit island H 72
plinth H 13

N.B.: possibilità di inserimento
luce sul cielo, per alimentatore
vedi listino luci L&S

Note: possibility
to insert light on
top, for the power
supply see L&S light
pricelist

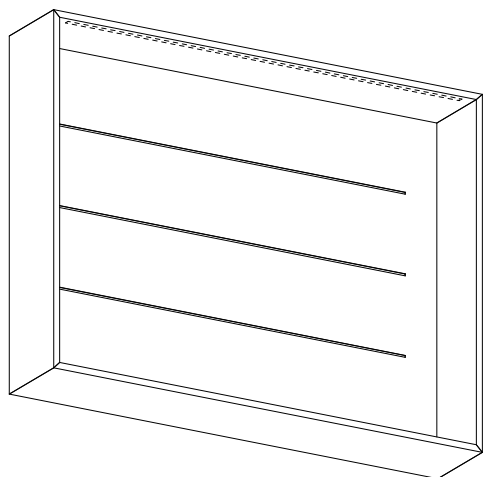

N.B.: Schienale non rifinito, non progettare a sbalzo
rispetto alle basi

Unfinished back panel, do not design cantilever
than the base unit

L 16,8 H 72 P 93,5
Luce 11,8W

W 16,8 H 72 D 93,5
Light 11,8W

086SHF57
08618326

CODICE
CODE No.

ROUND
PET

CLOVER
IMP.
FASCIA A

CLOVER
IMP.
FASCIA B

LUNA
IMP.
FASCIA A

LUNA
IMP.
FASCIA B

FLAVOUR
IMP.
FASCIA B

FLAVOUR
IMP.
FASCIA C

CLOVER
LUNA
FLAVOUR
LACCATO
OPACO

Finiture "BOISERIE"

"BOISERIE" finishes

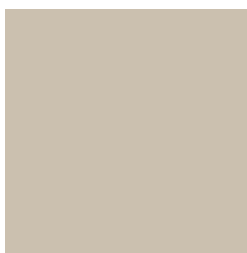

Desert (opz.D)

Desert

N.B.: riferimento immagine
(opz.8941) UV

Note: reference immagine
(opt.8941) UV

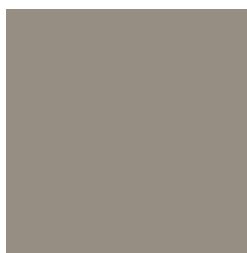

Stone Grey (opz.G)

Grey Stone

N.B.: riferimento immagine
melaminico (opz.9650)

Note: reference immagine
melamine (opt.9650)

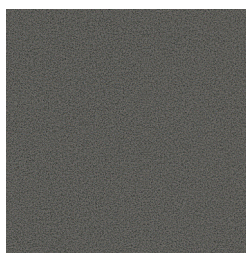

Silver Dark (opz.S)

Dark Silver

TERMINALI COVER

COVER END UNITS

**Terminale isola H 75
zoccolo H 13**

End unit island H 75 plinth H 13

**N.B.: possibilità di inserimento
luce sul cielo, per alimentatore
vedi listino luci L&S**

Note: possibility to insert light on top,
for the power supply see L&S light
pricelist

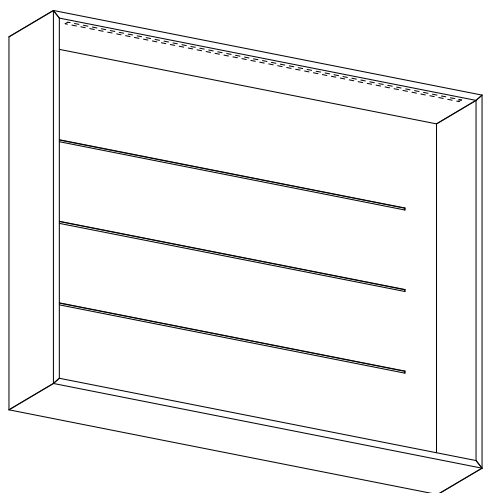

**N.B.: Schienale non rifinito, non progettare a sbalzo
rispetto alle basi**

Unfinished back panel, do not design cantilever
than the base unit

L 16,8 H 75 P 93,5
Luce 11,8W

W 16,8 H 75 D 93,5
Light 11,8W

**CODICE
CODE No.**

**ROUND
PET**

**CLOVER
IMP.
FASCIA A**

**CLOVER
IMP.
FASCIA B**

**FLAVOUR
IMP.
FASCIA B**

**FLAVOUR
IMP.
FASCIA C**

**CLOVER
FLAVOUR
LACCATO
OPACO**

**086SHF59
08618326**

Finiture "BOISERIE"

"BOISERIE" finishes

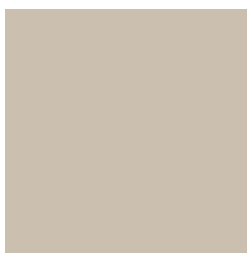

Desert (opz.D)

Desert

**N.B.: riferimento immagine
(opz.8941) UV**

Note: reference immagine
(opt.8941) UV

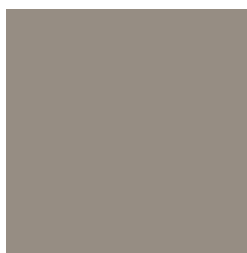

Stone Grey (opz.G)

Grey Stone

**N.B.: riferimento immagine
melaminico (opz.9650)**

Note: reference immagine
melamine (opt.9650)

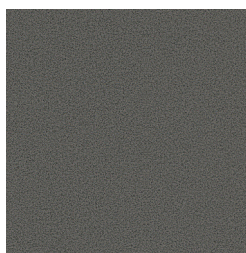

Silver Dark (opz.S)

Dark Silver

TERMINALI COVER

COVER END UNITS

**Terminale isola H 84
zoccolo H 6**

End unit island H 84 plinth H 6

**N.B.: possibilità di inserimento
luce sul cielo, per alimentatore
vedi listino luci L&S**

Note: possibility to insert light on top, for the
power supply see L&S light pricelist

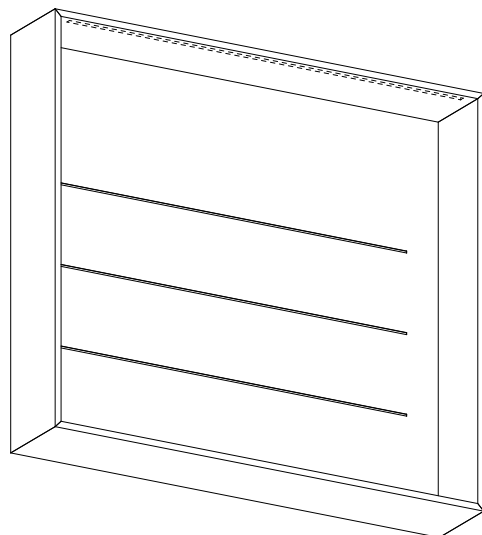

**N.B.: Schienale non rifinito, non progettare a sbalzo
rispetto alle basi**

Unfinished back panel, do not design cantilever
than the base unit

L 16,8 H 84 P 93,5
Luce 11,8W

W 16,8 H 84 D 93,5
Light 11,8W

086SHF67
08618326

CODICE
CODE No.

ROUND
PET

OLTRE
IMP.

FLAVOUR
IMP.
FASCIA B

FLAVOUR
IMP.
FASCIA C

OLTRE
FLAVOUR
LACCATO
OPACO

Finiture "BOISERIE"

"BOISERIE" finishes

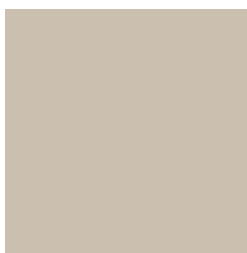

Desert (opz.D)

Desert

**N.B.: riferimento immagine
(opz.8941) UV**

Note: reference immagine
(opt.8941) UV

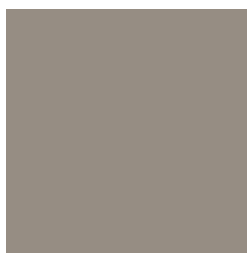

Stone Grey (opz.G)

Grey Stone

**N.B.: riferimento immagine
melaminico (opz.9650)**

Note: reference immagine
melamine (opt.9650)

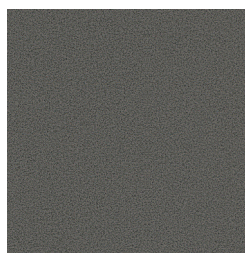

Silver Dark (opz.S)

Dark Silver

TERMINALI COVER

COVER END UNITS

Terminale cover con boiserie per colonna H 204
N.B.: possibilità di inserimento luci sui fianchi, per alimentatore vedi listino luci L&S

Cover end unit with boiserie for tall cabinet H 204
 Note: possibility to insert lights on side panels, for the power supply see L&S light pricelist

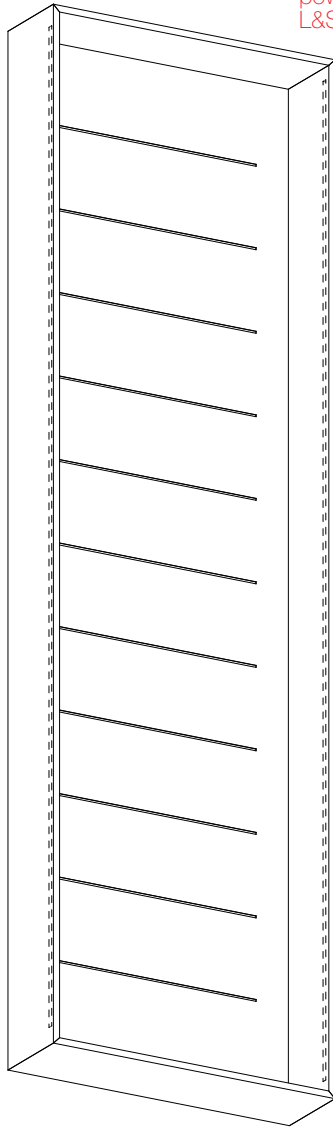

L 16,8 H 204 P 60 DX
 L 16,8 H 204 P 60 SX
 Luce nr.2 54W

W 16,8 H 204 D 60 DX
 W 16,8 H 204 D 60 SX
 Light nr.2 54W

CODICE
CODE No.

ROUND
PET

CLOVER
IMP.
FASCIA A

CLOVER
IMP.
FASCIA B

LUNA
IMP.
FASCIA A

LUNA
IMP.
FASCIA B

FLAVOUR
IMP.
FASCIA B

FLAVOUR
IMP.
FASCIA C

CLOVER
LUNA
FLAVOUR
LACCATO
OPACO

086SHF201
086SHF202
08618327

Finiture "BOISERIE"

"BOISERIE" finishes

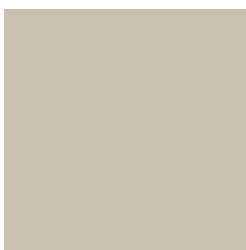

Desert (opz.D)

Desert

N.B.: riferimento immagine (opz.8941) UV

Note: reference immagine (opt.8941) UV

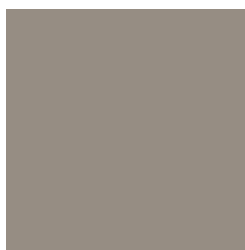

Stone Grey (opz.G)

Grey Stone

N.B.: riferimento immagine melaminico (opz.9650)

Note: reference immagine melamine (opt.9650)



Silver Dark (opz.S)

Dark Silver

TERMINALI COVER

COVER END UNITS

Terminale cover con boiserie per colonna H 216
N.B.: possibilità di inserimento luci sui fianchi, per alimentatore vedi listino luci L&S

Cover end unit with boiserie for tall cabinet H 216
 Note: possibility to insert lights on side panels, for the power supply see L&S light pricelist

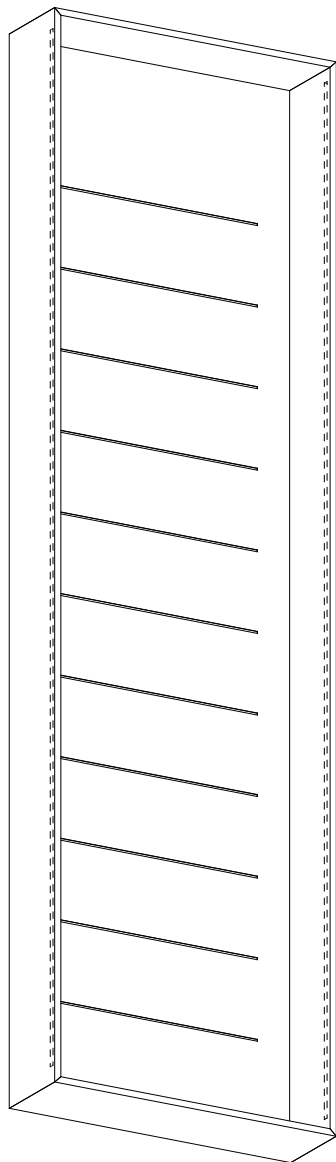

L 16,8 H 216 P 60 DX
 L 16,8 H 216 P 60 SX
 Luce nr.2 56,6W

W 16,8 H 216 D 60 DX
 W 16,8 H 216 D 60 SX
 Light nr.2 56,6W

CODICE
CODE No.

ROUND
PET

OLTRE
IMP.

FLAVOUR
IMP.
FASCIA B

FLAVOUR
IMP.
FASCIA C

OLTRE
FLAVOUR
LACCATO
OPACO

086SHF211
086SHF212
08618328

Finiture "BOISERIE"

"BOISERIE" finishes

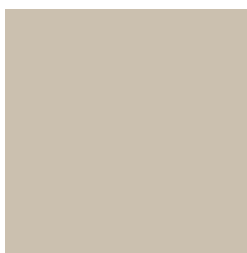

Desert (opz.D)

Desert

N.B.: riferimento immagine (opz.8941) UV

Note: reference immagine (opt.8941) UV

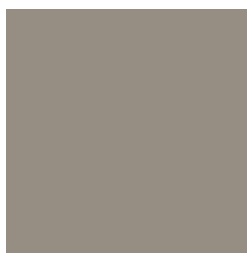

Stone Grey (opz.G)

Grey Stone

N.B.: riferimento immagine melaminico (opz.9650)

Note: reference immagine melamine (opt.9650)



Silver Dark (opz.S)

Dark Silver

COLORI TERMINALI COVER

COVER END UNITS COLOURS

COLORI IMPIALLACCIATI MODELLO LUNA

LUNA MODEL VENEERED COLOURS

FASCIA "A"

BAND "A"

 <p>rovere bianco (opz.5429), fiamma orizzontale white oak (opt.5429), horizontal grain</p>	 <p>rovere grigio reale (opz.5432), fiamma orizzontale royal grey oak (opt.5432), horizontal grain</p>	 <p>rovere grigio traffico (opz.5431), fiamma orizzontale traffic grey oak (opt.5431), horizontal grain</p>	 <p>rovere carbon (opz.5434) fiamma orizzontale carbon oak (opt.5434), horizontal grain</p>
 <p>rovere natur (opz.5440) fiamma orizzontale natur oak (opt.5440), horizontal grain</p>	 <p>rovere lino (opz.5430) fiamma orizzontale linen oak (opt.5430), horizontal grain</p>	 <p>rovere moresco (opz.5433) fiamma orizzontale moresco oak (opt.5433), horizontal grain</p>	

FASCIA "B"

BAND "B"

 <p>noce canaletto (opz.1331) fiamma orizzontale canaletto walnut (opt.1331), horizontal grain</p>
--

COLORI IMPIALLACCIATI MODELLO CLOVER

CLOVER MODEL VENEERED COLOURS



FASCIA "A"

BAND "A"

 <p>rovere grigio nebbia (opz.5401), fiamma verticale mist grey oak (opt.5401), vertical grain</p>	 <p>rovere polvere (opz.5402), fiamma verticale dust oak (opt.5402), vertical grain</p>	 <p>rovere grafite (opz.5403), fiamma verticale graphite oak (opt.5403), vertical grain</p>	 <p>rovere naturale (opz.5404), fiamma verticale natural oak (opt.5404), vertical grain</p>
 <p>rovere sahara (opz.5416), fiamma orizzontale sahara oak (opt.5416), horizontal grain</p>	 <p>rovere visone (opz.5417), fiamma orizzontale mink oak (opt.5417), horizontal grain</p>	 <p>rovere grigio cenere (opz.5418), fiamma orizzontale ash grey oak (opt.5418), horizontal grain</p>	 <p>rovere lavagna (opz.5419), fiamma orizzontale slate grey oak (opt.5419), horizontal grain</p>
 <p>rovere tabacco (opz.5405), fiamma verticale tobacco oak (opt.5405), vertical grain</p>	 <p>rovere bianco (opz.5415), fiamma orizzontale white oak (opt.5415), horizontal grain</p>	 <p>rovere nero (opz.5420), fiamma orizzontale black oak (opt.5420), horizontal grain</p>	 <p>rovere cenere (opz.5409) fiamma verticale, senza nodo ash oak (opt.5409), vertical grain, without knots</p>
 <p>rovere tan (opz.5408) fiamma verticale, senza nodo tan oak (opt.5408), vertical grain, without knots</p>			

FASCIA "B"

BAND "B"

 <p>rovere termocotto (opz.5410), fiamma verticale thermo-treated oak (opt.5410), vertical grain</p>	 <p>noce canaletto (opz.1324), fiamma verticale canaletto walnut (opt.1324), vertical grain</p>
--	--

COLORI TERMINALI COVER

COVER END UNITS COLOURS

COLORI IMPIALLACCIATI MODELLO OLTRE

OLTRE MODEL VENEERED COLOURS



COLORI IMPIALLACCIATI MODELLO ROUND

ROUND MODEL VENEERED COLOURS



COLORI TERMINALI COVER

COVER END UNITS COLOURS

COLORI IMPIALLACCIATI MODELLO FLAVOUR

FLAVOUR MODEL VENEERED COLOURS

FASCIA "B"

BAND "B"



FASCIA "C"

BAND "C"



COLORI LACCATI OPACHI

MATT LACQUERED COLOURS

COLORI FREDDI OPACHI SOFT SOFT MATT COLD COLOURS





COLORI TERMINALI COVER

COVER END UNITS COLOURS

COLORI LACCATI OPACHI

MATT LACQUERED COLOURS

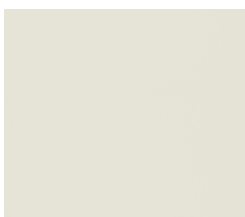
COLORI CALDI OPACHI SOFT SOFT MATT HOT COLOURS

				
bianco caldo (opz.7401) warm white	grigio kenya (opz.9501) kenya grey	bistro (opz.9535) bistro	cannella (opz.8893) cinnamon	grigio reale (opz.95F3) royal grey
				
conchiglia (opz.7403) seashell	lino (opz.9513) linen	creta (opz.9515) clay	rosso persia (opz.8165) persia red	giallo zafferano (opz.8253) saffron yellow
				
grigio lava (opz.95F1) lava grey	polvere (opz.9539) dust	platino (opz.7773) platinum	nocciola (opz.7775) walnut	cuoio (opz.8897) leather
				
grigio piombo (opz.9537) lead grey	grigio quarzo (opz.95F7) quartz grey	azzurro nube (opz.8379) cloud blue	verde bosco (opz.8468) forest green	fumo (opz.9531) smoke
	NEW 	NEW 	NEW 	NEW 
tortora (opz.8993) dove grey	NEW carruba (opz.89L1) carruba	NEW azzurro ottanio (opz.8385) teal blue	NEW verde borneo (opz.8483) borneo green	NEW verde cinabro (opz.8481) cinabro green
NEW 	NEW 	NEW 	NEW 	NEW 
NEW cotto (opz.8887) cooked	NEW rosso (opz.125S) red	NEW granato (opz.8633) ruby red	NEW verde celadon (opz.8485) celadon green	NEW giallo digione (opz.8257) digione yellow

BOISERIE "QUADRO"

"QUADRO" BOISERIE

Boiserie "QUADRO"

"QUADRO" boiserie

CODICE
CODE No.

DESERT

STONE
GREY

SILVER
DARK

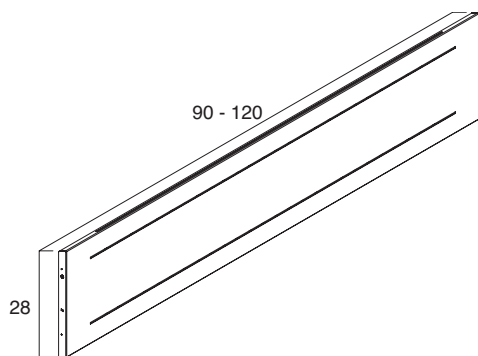
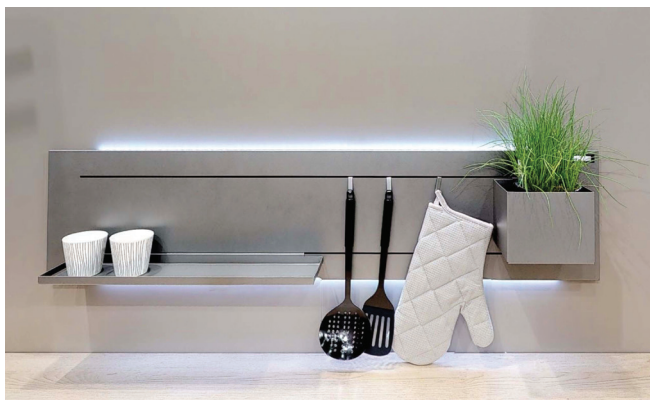

Pannello "QUADRO"
90X28
120X28

"QUADRO" back panel
90x28
120x28

086QU090
086QU120

Pannello "QUADRO" con led touch e
trasformatore EU
90X28 DX
120X28 DX

"QUADRO" back panel with led touch and
transformer EU
90x28 RH
120x28 RH

086QULD090
086QULD120

90X28 SX
120X28 SX

90x28 LH
120x28 LH

086QULS090
086QULS120

Pannello "QUADRO" con led touch e
trasformatore USA/CANADA
90X28 DX
120X28 DX

"QUADRO" back panel with led touch and
transformer US/CANADA
90x28 RH
120x28 RH

086QULD091
086QULD121

90X28 SX
120X28 SX

90x28 LH
120x28 LH

086QULS091
086QULS121

Finiture "BOISERIE"

"BOISERIE" finishes

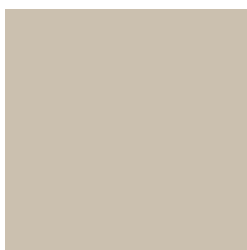

Desert (opz.D)

Desert

N.B.: riferimento immagine
(opz.8941) UV

Note: reference immagine
(opt.8941) UV

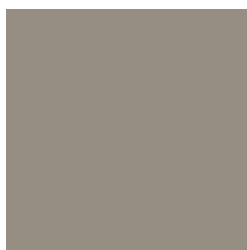

Stone Grey (opz.G)

Grey Stone

N.B.: riferimento immagine
melaminico (opz.9650)

Note: reference immagine
melamine (opt.9650)

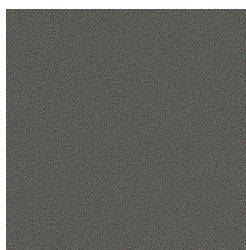

Silver Dark (opz.S)

Dark Silver

BOISERIE "QUADRO"

"QUADRO" BOISERIE

Nel caso di mancato collegamento ad un punto luce nella parte posteriore del pannello Quadro al fine di nascondere il passaggio del filo in direzione del punto luce esterno si consiglia il posizionamento di un pannello tra base e pensile da scegliere in base alla progettazione.

Vedi esempio sotto

In case of missing connection to a light point in the rear part of the Quadro panel, in order to hide the passage of the wire in the direction of the external light point, it is recommended to place a panel between the base unit and the wall unit to be selected according to the project. See example below

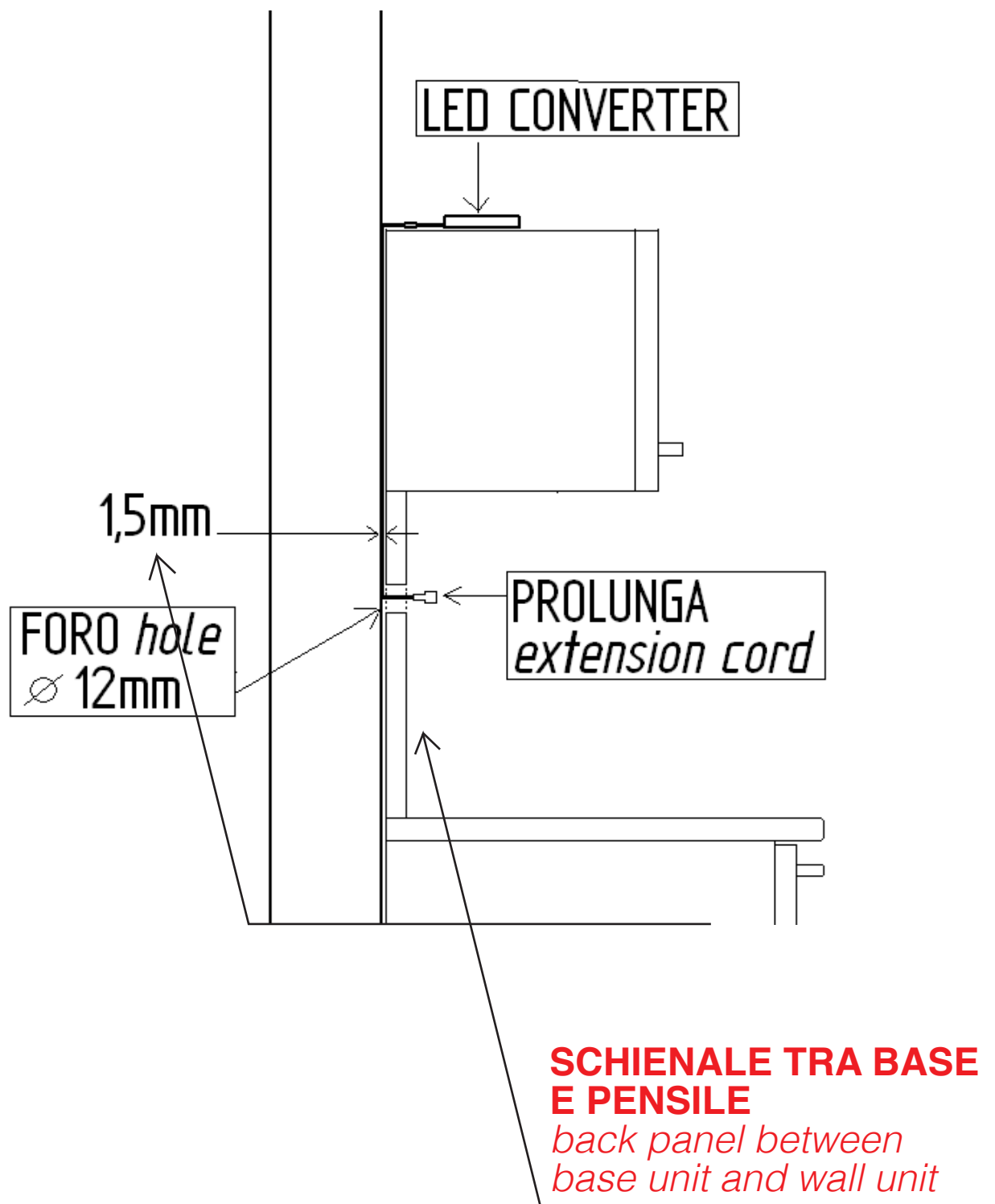

ACCESSORI

ACCESSORIES

	Vano a giorno	Open compartment	CODICE CODE No.	DESERT	STONE GREY	SILVER DARK
						
	L 14,8 P 22 H 31,4	W 14,8 D 22 H 31,4	086SHA28			
						
	L 38,8 P 22 H 31,4	W 38,8 D 22 H 31,4	086SHA29			
						
	L 53,8 P 22 H 31,4	W 53,8 D 22 H 31,4	086SHA30			

ACCESSORI

ACCESSORIES

		CODICE CODE No.	DESERT	STONE GREY	SILVER DARK
<p>Porta Tablet</p>  <p>L 20 P 14 H 19,3</p>	<p>Tablet rack</p> <p>W 20 D 14 H 19,3</p>	086SHA23			
<p>Porta Riviste</p>  <p>L 48,6 P 10,7 H 27,7</p>	<p>Open compartment</p> <p>W 48,6 D 10,7 H 27,7</p>	086SHA26			
<p>Parafiamma</p>  <p>L 59 P 9 H 21 L 89 P 9 H 21</p>	<p>Firewall</p> <p>W 59 D 9 H 21 W 58 D 9 H 21</p>	086SHA40 086SHA41			

ACCESSORI

ACCESSORIES

		CODICE CODE No.	DESERT	STONE GREY	SILVER DARK
<p>Mensola Portacalici Glassholder</p>  <p>L 38,5 P 11,3 H 4 W 38,5 D 11,3 H 4</p>	086SHA20				
<p>Mensola Portacalici Glassholder</p>  <p>L 53,6 P 11,3 H 4 W 53,6 D 11,3 H 4</p>	086SHA21				
<p>Porta Bottiglie Bottle rack</p>  <p>L 24 P 18,5 H 8,3 W 24 D 18,5 H 8,3</p>	086SHA24				

ACCESSORI

ACCESSORIES

<p>Gancio</p> <p>Hook</p>  <p>Nr.4 pezzi L 9 P 10 H 3,4</p>	<p>CODICE <i>CODE No.</i></p> <p>086SHA27</p>	<p>DESERT</p>	<p>STONE GREY</p>	<p>SILVER DARK</p>
<p>Porta Carta</p> <p>Paper rack</p>  <p>L 24 P 8,3 H 10,8</p>	<p>086SHA25</p>			
<p>Mensola Portacoltelli</p> <p>Knife rack</p>  <p>L 41,6 P 15 H 5,8</p>	<p>086SHA22</p>			

ACCESSORI

ACCESSORIES

Mensola	Rack	CODICE CODE No.	DESERT	STONE GREY	SILVER DARK
		086SHA01			
		086SHA05			
		086SHA06			

ACCESSORI

ACCESSORIES

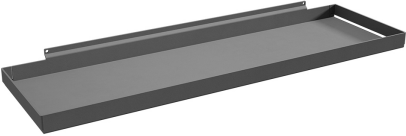
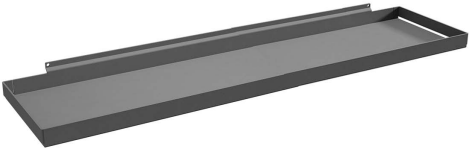
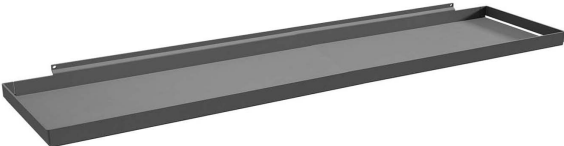
Ripiano Shelf  <th data-bbox="1098 159 1230 824">CODICE <i>CODE No.</i></th> <th data-bbox="1230 159 1329 824">DESERT</th> <th data-bbox="1329 159 1425 824">STONE GREY</th> <th data-bbox="1425 159 1517 824">SILVER DARK</th>	CODICE <i>CODE No.</i>	DESERT	STONE GREY	SILVER DARK
L 38,6 P 11,3 H 1,6 W 38,6 D 11,3 H 1,6	086SHA10			
Ripiano Shelf 	086SHA11			
Ripiano Shelf 	086SHA12			

ACCESSORI

ACCESSORIES

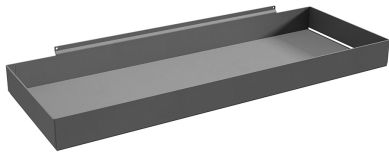
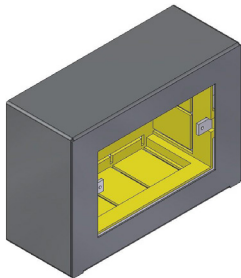
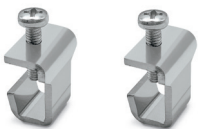
	Ripiano	Shelf		CODICE <i>CODE No.</i>	DESERT	STONE GREY	SILVER DARK
							
	L 41,6 P 15 H 3,4	W 41,6 D 15 H 3,4		086SHA15			
	Presa elettrica per boiserie N.B.: schema fissaggio all'interno dell'imballo	Electrical socket for boiserie Note: fixing diagram inside the packaging					
				086SHA45			
	Kit ferramenta per bloccaggio pannello telescopico N.B.: per boiserie in appoggio	Hardware kit for telescopic panel locking Note: boiserie on support					
			Nr.2 pezzi Nr.2 pieces	086SHA50			

ACCESSORI

ACCESSORIES

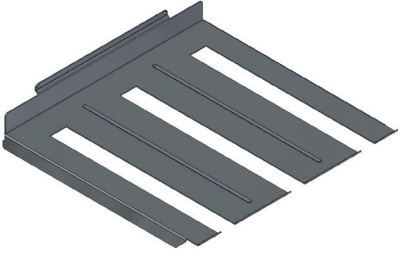
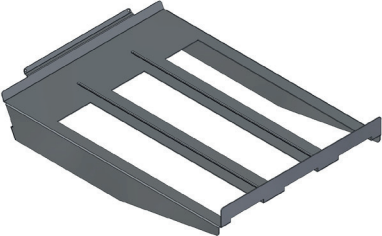
		Compensatore ad "U" H max 1319 mm realizzato a misura in altezza come pannello	"U" shaped compensator max height 1319 mm manufactured in the same height as the panel	CODICE <i>CODE No.</i>	DESERT	STONE GREY	SILVER DARK
		Larghezza mm 12 Larghezza mm 30 Larghezza mm 50	Length mm 12 Length mm 30 Length mm 50	086SHC12 086SHC30 086SHC50			
		Portacalici	Glassholder				
L 24,3 P 24 H 3,5		W 24,3 D 24 H 3,5		086SHA31			
		Porta Bottiglie	Bottle rack				
L 24,3 P 28,1 H 15,7		W 24,3 D 28,1 H 15,7		086SHA32			

COLONNA COVER

COVER END COLUMN

Colonna cover con boiserie
H 204 accessoriata
**N.B.: possibilità di inserimento
luci sui fianchi, per alimentatore
vedi listino luci L&S**

Cover column with
boiserie H 204
equipped
Note: possibility
to insert lights on
side panels, for the
power supply see
L&S light pricelist

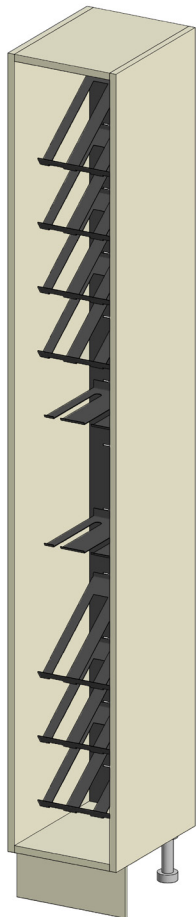

L 30 H 204 P 38
Luce nr.2 54W

W 30 H 204 D 38
Light nr.2 54W

086SHE200
08618327

CODICE
CODE No.

FASCIA
1
MELAMINICO
FASCIA A

FASCIA
2
MELAMINICO
FASCIA B
LACCATO UV

FASCIA
3
WOOD
MATHERA
PET FASCIA A
ALKORCEL

FASCIA
4
PET
FASCIA B

FASCIA
5
LACCATO
OPACO

FASCIA
6
IMPIALLAC.
FASCIA A

FASCIA
7
IMPIALLAC.
FASCIA B

FASCIA
8
IMPIALLAC.
FASCIA C

Modelli disponibili Available models

Fascia 1: Unica, Immagina, Tablet, Rewind

Bend 1

Fascia 2: Unica, Immagina Laccata, Tablet Laccata

Bend 2

Fascia 3: Immagina Wood, Immagina Mathera, Tablet Wood, Round, Smart fascia A

Bend 3

Fascia 4: Smart fascia B

Bend 4

Fascia 5: Clover, Flavour, Oltre, Luna, Contempo

Bend 5

Fascia 6: Flavour, Contempo

Bend 6

Fascia 7: Flavour, Luna, Clover

Bend 7

Fascia 8: Luna, Clover

Bend 8

COLONNA COVER

COVER END COLUMN

Colonna cover con boiserie H 216 accessoriata
N.B.: possibilità di inserimento luci sui fianchi, per alimentatore vedi listino luci L&S

Cover column with boiserie H 216 equipped
 Note: possibility to insert lights on side panels, for the power supply see L&S light pricelist

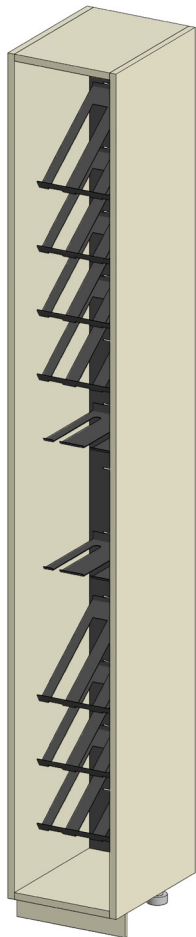

L 30 H 216 P 38
 Luce nr.2 54W

W 30 H 216 D 38
 Light nr.2 54W

086SHE201
08618327

CODICE CODE No.	FASCIA 1 MELAMINICO FASCIA A	FASCIA 2 MELAMINICO FASCIA B LACCATO UV	FASCIA 3 WOOD MATHERA PET FASCIA A ALKORCEL	FASCIA 4 PET FASCIA B	FASCIA 5 LACCATO OPACO	FASCIA 6 IMPIALLAC. FASCIA A	FASCIA 7 IMPIALLAC. FASCIA B	FASCIA 8 IMPIALLAC. FASCIA C

Modelli disponibili Available models

Fascia 1: Immagina, Tablet

Bend 1

Fascia 2: Immagina Laccata, Tablet Laccata

Bend 2

Fascia 3: Immagina Wood, Immagina Mathera, Tablet Wood, Round

Bend 3

Fascia 4: —

Bend 4

Fascia 5: Flavour, Oltre

Bend 5

Fascia 6: Flavour

Bend 6

Fascia 7: Flavour, Oltre

Bend 7

Fascia 8: —

Bend 8

CUCINE
LUBE

GRUPPO LUBE



CREO
KITCHENS

Dama







ACCESSORI "DAMA"

"DAMA" ACCESSORIES

	Cremagliera da parete in alluminio verniciato	Aluminium painted wall rack system	CODICE <i>CODE No.</i>			
			08600780W 08600780G 08600780SD 08600780N			
						08600785W 08600785G 08600785SD 08600785N
						



ACCESSORI "DAMA"

"DAMA" ACCESSORIES

	<p>Set 3 ganci in alluminio verniciato</p>	<p>Kit of 3 aluminium painted hooks</p>	<p>CODICE / CODE No.</p>	
	<p>Set 3 ganci portapentole in alluminio verniciato</p>	<p>Kit of 3 aluminium painted pan holder hooks</p>	<p>08600795W 08600795G 08600795SD 08600795N</p>	
	<p>Portarotolo in alluminio verniciato con corpo in legno faggio</p>	<p>Aluminium roll holder Painted, with beech wooden body</p>	<p>08600796W 08600796G 08600796SD 08600796N</p>	
	<p>Portabottiglie con binario portacalici</p>	<p>Bottles rack with stem glasses holder</p>	<p>08600797W 08600797G 08600797SD 08600797N</p>	
	<p>08600798W 08600798G 08600798SD 08600798N</p>	<p>08600798W 08600798G 08600798SD 08600798N</p>	<p>08600798W 08600798G 08600798SD 08600798N</p>	

ACCESSORI "DAMA"

"DAMA" ACCESSORIES

	<p>Sacchetti contenitori Set 3 ganci in alluminio verniciato non compreso da ordinare separatamente</p> <p>Container bags Kit of 3 painted aluminium hooks is not included, must be ordered separately</p>	<p>CODICE / CODE No.</p> <p>08600800G 08600800M</p> <p>08600799G 08600799M</p>	
	<p>Mensola in alluminio verniciato</p> <p>Aluminium painted shelf</p>	<p>08600801W 08600801G 08600801SD 08600801N</p> <p>08600802W 08600802G 08600802SD 08600802N</p> <p>08600803W 08600803G 08600803SD 08600803N</p>	



ACCESSORI "DAMA"

"DAMA" ACCESSORIES

Portabarattoli
L 27 P 14 H 7,5

Jar rack
W 27 D 14 H 7,5

CODICE / CODE No.

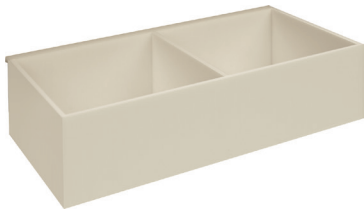

Adattatore per portabarattoli
Jar rack adapter

Bianco
Grigio Selce
Silver Dark
Nero

White
Flint Grey
Dark Silver
Black

08600794W
08600794G
08600794SD
08600794N

Colori opachi disponibili per portabarattoli

Available matt colours for Jar rack

bianco assoluto
(opz.740)
white absolute

conchiglia
(opz.7403)
seashell

grigio traffico
(opz.9511)
traffic grey

tortora
(opz.8993)
dove grey

nero
(opz.7892)
black



GRUPPOLUBE



CANALI ATTREZZATI

2023

MATERIALI

MATERIALS

2 Materiali | *Materials*

4 Canale a incasso | Low depth back section

16 Canale in appoggio | *Lay-on back section*

24 Alzata in appoggio | *Lay-on double back section*

30 Finiture | *Finishings*



ADATTO AL CONTATTO CON ALIMENTI
SUITABLE FOR FOODSTUFF CONTACT



ANTI GRAFFIO
RESISTANT TO SCRATCHES



RESISTENTE AD ACQUA E VAPORE
RESISTANT TO WATER AND STEAM



ANTI IMPRONTE
ANTI-FINGERPRINTS



RESISTENTE AI SOLVENTI
RESISTANT TO ACID SOLVENTS



ECCELLENTI PROPRIETÀ IGIENICHE
EXCELLENT HYGIENIC PROPERTIES

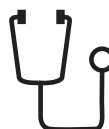

PROPRIETÀ ANTI BATTERICHE
ANTI-BACTERIAL PROPERTIES



ANTISTATICO
ANTISTATIC

Un design semplice e iconico, e un uso di materiali d'avanguardia, sono le principali caratteristiche che rendono il sistema BelNet innovativo e pragmatico. La scelta dell'utilizzo del laminato compatto in spessore 4mm come materiale per la realizzazione degli accessori, è frutto di una ricerca accurata che ha avuto come punto di arrivo la selezione di un materiale resistente all'acqua, al vapore, facile da pulire, ma anche ad alta igienicità e con buone proprietà antibatteriche e antigraffio, tutte caratteristiche che rendono questo materiale perfetto se utilizzato al contatto con il cibo.

A simple yet iconic design and the use of avant-garde materials are the features that make the BelNet system innovative and pragmatic. The choice to use compact laminate as the main component of our kitchen accessories is fruit of an extensive research aimed to find a material that not only is water and steam resistant, durable and and easy to clean, but also a material with highly hygienic and antibacterial properties, that is at the same time scratch resistant and particularly apt to be in contact with food and moisture.



POSSIBILITÀ DI PERSONALIZZAZIONE
POSSIBLE TO CUSTOMIZE



FACILE DA PULIRE
EASY TO CLEAN

CANALE A INCASSO

LOW DEPTH BACK SECTION

2 Materiali | *Materials*

4 Canale a incasso | *Low depth back section*

16 Canale in appoggio | *Lay-on back section*

24 Alzata in appoggio | *Lay-on double back section*

30 Finiture | *Finishings*



Disegnato per creare uno spazio contenitivo sul top della cucina, il canale attrezzato ad incasso porta una organizzazione e una accessibilità estremamente interessanti a questa parte della cucina.

Realizzato in differenti lunghezze, questo canale attrezzato può essere accessorato con tutti gli elementi della linea BelNet 472 con l'aggiunta dell'opzione del vassoio elettrificato, rivelandosi così ideale per organizzare tutti i tipi e dimensioni di top delle cucine.

Designed to increase storage space on the kitchen counter, our Low Depth Back Section brings organization and accessibility upfront. Coming in five standard measures, and three standard finishings the Low-Depth Back Section can satisfy every cook's need for practicality.

Equipped with the BelNet 472 inserts, this back section can also be furnished with an exclusive Electricity Tray supplied with two Schuko outlets. Extremely versatile and practical, the Low Depth Back Section not only deepens the kitchen counter, but also brings along an orderly elegance.

■ CANALE A INCASSO - MODULO CON SCOLO
LOW DEPTH BACK SECTION - MODULE WITH WATER DRAINAGE

ESEMPIO DI APPLICAZIONE DEL MODULO SENZA MISCELATORE
EXAMPLE OF APPLICATION OF MODULE WITHOUT INTEGRATED FAUCET



**CANALE A INCASSO
MODULO 900 CON SCOLO**

LOW DEPTH BACK SECTION - MODULE 900 WITH WATER DRAINAGE



CODICE CODE	FINITURA FINISHING	MODULO (mm) MODULE (mm)	MISURE (mm) MEASURE (mm)
0865C0091G	Ghisa Cast Iron	900	860 x 200
0865C0091S	Silver Dark Dark Silver	900	860 x 200
0865C0091N	Nero Black	900	860 x 200

**_attacco a scarico acqua
_attach to the water discharge**

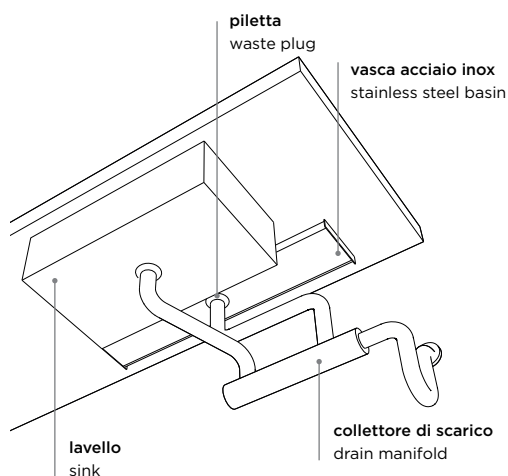
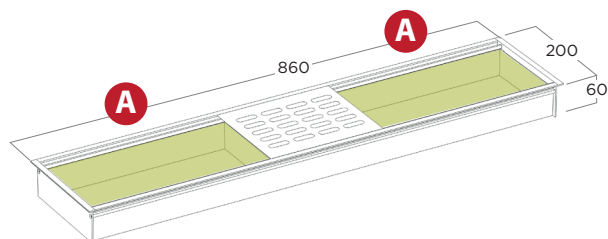

PORTA PIATTI GHISA
PLATE HOLDER CAST IRON

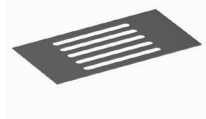

0865C0901G

PORTA PIATTI SILVER DARK
PLATE HOLDER DARK SILVER



0865C0901S

PORTA PIATTI NERO
PLATE HOLDER BLACK



0865C0901N

GOCCIOLATOIO GHISA
DRIP PLAT CAST IRON

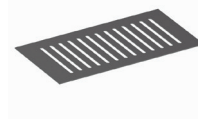

0865C0902G

GOCCIOLATOIO SILVER DARK
DRIP PLAT DARK SILVER

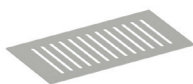

0865C0902S

GOCCIOLATOIO NERO
DRIP PLAT BLACK

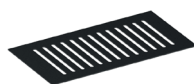

0865C0902N

VASCHETTA POSATE GHISA
TRAY FOR CUTTERY CAST IRON

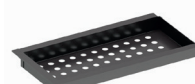

0865C0903G

VASCHETTA POSATE
SILVER DARK
TRAY FOR CUTTERY
DARK SILVER

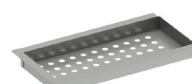

0865C0903S

VASCHETTA POSATE NERO
TRAY FOR CUTTERY BLACK



0865C0903N

CANALE A INCASSO - MODULO CON SCOLO
LOW DEPTH BACK SECTION - MODULE WITH WATER DRAINAGE

ESEMPIO DI APPLICAZIONE DEL MODULO CON MISCELATORE
EXAMPLE OF APPLICATION OF MODULE WITH INTEGRATED FAUCET



CANALE A INCASSO - MODULO 900 CON SCOLO E ATTACCO PER MISCELATORE

LOW DEPTH BACK SECTION - MODULE 900 WITH WATER DRAINAGE AND ATTACH FOR FAUCET



CODICE CODE	FINITURA FINISHING	MODULO (mm) MODULE (mm)	MISURE (mm) MEASURE (mm)
0865C0092G	Ghisa Cast Iron	900	860 x 200
0865C0092S	Silver Dark Dark Silver	900	860 x 200
0865C0092N	Nero Black	900	860 x 200

Miscelatore non incluso
Faucet not included

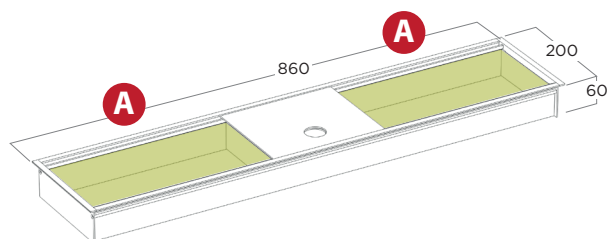

_attacco a scarico acqua _attach to the water discharge

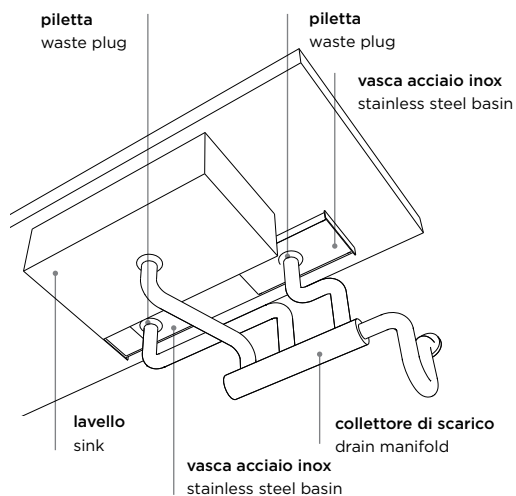

PORTA PIATTI GHISA
PLATE HOLDER CAST IRON

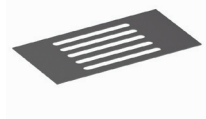

0865C0901G

PORTA PIATTI SILVER DARK
PLATE HOLDER DARK SILVER



0865C0901S

PORTA PIATTI NERO
PLATE HOLDER BLACK



0865C0901N

GOCCIOLATOIO GHISA
DRIP PLAT CAST IRON

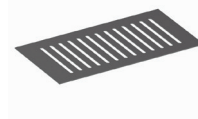

0865C0902G

GOCCIOLATOIO SILVER DARK
DRIP PLAT DARK SILVER

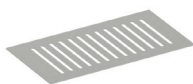

0865C0902S

GOCCIOLATOIO NERO
DRIP PLAT BLACK

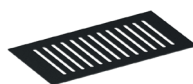

0865C0902N

VASCHETTA POSATE GHISA
TRAY FOR CUTTERY CAST IRON

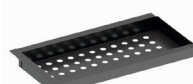

0865C0903G

VASCHETTA POSATE SILVER DARK
TRAY FOR CUTTERY DARK SILVER

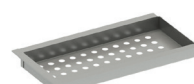

0865C0903S

VASCHETTA POSATE NERO
TRAY FOR CUTTERY BLACK



0865C0903N

CANALE A INCASSO - MODULO 900 LOW DEPTH BACK SECTION - MODULE 900

 **A** + **B** oppure **C**

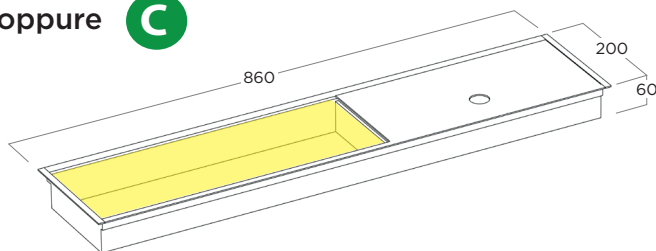

CODICE CODE	FINITURA FINISHING	MODULO (mm) MODULE (mm)	MISURE (mm) MEASURE (mm)
0865C0090G	Ghisa Cast Iron	900	860 x 200
0865C0090S	Silver Dark Dark Silver	900	860 x 200
0865C0090N	Nero Black	900	860 x 200

VASCHETTA UNIVERSALE OAK DARK BROWN
UNIVERSAL TRAY OAK DARK BROWN

A

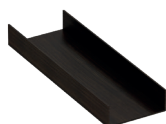

0865C0900

+

B

PORTA COLTELLI GHISA
KNIVES RACK DARK CAST IRON

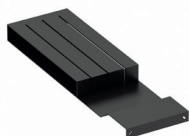

0865C0904G

PORTA OGGETTI GHISA
OBJECT HOLDERS CAST IRON

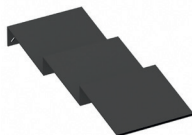

0865C0905G

PORTA SPEZIE GHISA
SPICE JARS HOLDER CAST IRON



0865C0906G

PORTA BARATTOLI GHISA
ARS HOLDER CAST IRON



0865C0907G

PORTA COLTELLI SILVER DARK
KNIVES RACK DARK SILVER

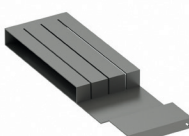

0865C0904S

PORTA OGGETTI SILVER DARK
OBJECT HOLDERS DARK SILVER

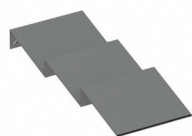

0865C0905S

PORTA SPEZIE SILVER DARK
SPICE JARS HOLDER DARK SILVER



0865C0906S

PORTA BARATTOLI SILVER DARK
ARS HOLDER DARK SILVER



0865C0907S

PORTA COLTELLI NERO
KNIVES RACK BLACK

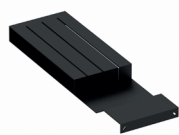

0865C0904N

PORTA OGGETTI NERO
OBJECT HOLDERS BLACK

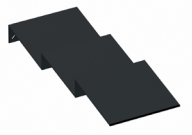

0865C0905N

PORTA SPEZIE NERO
SPICE JARS HOLDER BLACK



0865C0906N

PORTA BARATTOLI NERO
ARS HOLDER BLACK



0865C0907N

oppure

C

VASCHETTA ELETTTRIFICATA GHISA
ELECTRICAL TRAY CAST IRON



0865C0908G

VASCHETTA ELETTTRIFICATA SILVER DARK
ELECTRICAL TRAY DARK SILVER



0865C0908S

VASCHETTA ELETTTRIFICATA NERO
ELECTRICAL TRAY BLACK



0865C0908N

CANALE A INCASSO - MODULO 1200

LOW DEPTH BACK SECTION - MODULE 1200

 **A** + **B** oppure **C**

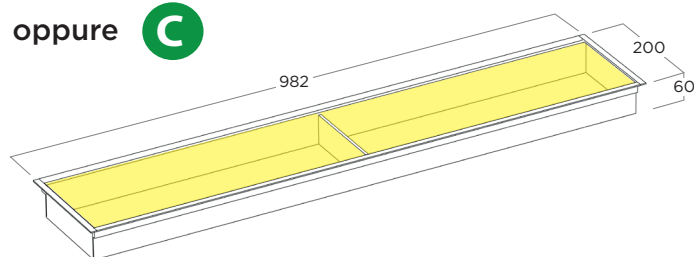

CODICE CODE	FINITURA FINISHING	MODULO (mm) MODULE (mm)	MISURE (mm) MEASURE (mm)
0865C0120G	Ghisa Cast Iron	1200	982 x 200
0865C0120S	Silver Dark Dark Silver	1200	982 x 200
0865C0120N	Nero Black	1200	982 x 200

VASCETTA UNIVERSALE OAK DARK BROWN
UNIVERSAL TRAY OAK DARK BROWN

A

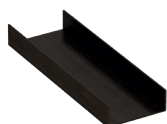

0865C0900

+

B

PORTA COLTELLI GHISA
KNIVES RACK DARK CAST IRON

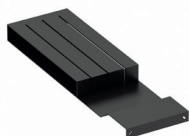

0865C0904G

PORTA OGGETTI GHISA
OBJECT HOLDERS CAST IRON

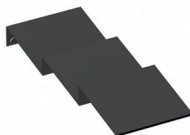

0865C0905G

PORTA SPEZIE GHISA
SPICE JARS HOLDER CAST IRON



0865C0906G

PORTA BARATTOLI GHISA
ARS HOLDER CAST IRON



0865C0907G

PORTA COLTELLI SILVER DARK
KNIVES RACK DARK SILVER

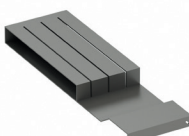

0865C0904S

PORTA OGGETTI SILVER DARK
OBJECT HOLDERS DARK SILVER

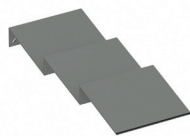

0865C0905S

PORTA SPEZIE SILVER DARK
SPICE JARS HOLDER DARK SILVER



0865C0906S

PORTA BARATTOLI SILVER DARK
ARS HOLDER DARK SILVER



0865C0907S

PORTA COLTELLI NERO
KNIVES RACK BLACK

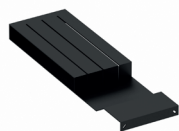

0865C0904N

PORTA OGGETTI NERO
OBJECT HOLDERS BLACK

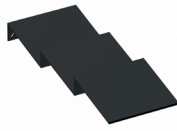

0865C0905N

PORTA SPEZIE NERO
SPICE JARS HOLDER BLACK



0865C0906N

PORTA BARATTOLI NERO
ARS HOLDER BLACK



0865C0907N

oppure

C

VASCETTA ELETTTRIFICATA GHISA
ELECTRICAL TRAY CAST IRON



0865C0908G

VASCETTA ELETTTRIFICATA SILVER DARK
ELECTRICAL TRAY DARK SILVER



0865C0908S

VASCETTA ELETTTRIFICATA NERO
ELECTRICAL TRAY BLACK



0865C0908N

CANALE A INCASSO - MODULO 1500 LOW DEPTH BACK SECTION - MODULE 1500

 **A** + **B** oppure **C**

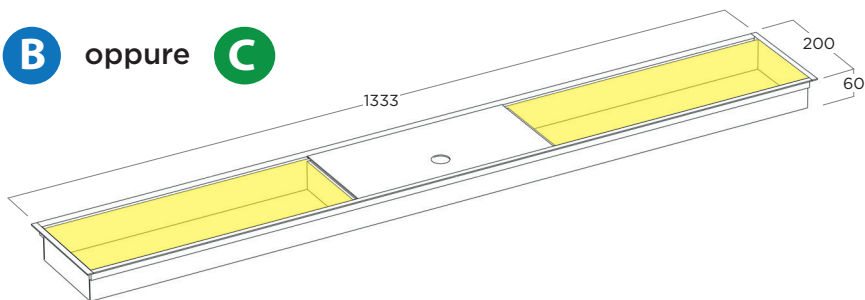

CODICE CODE	FINITURA FINISHING	MODULO (mm) MODULE (mm)	MISURE (mm) MEASURE (mm)
0865C0150G	Ghisa Cast Iron	1500	1333 x 200
0865C0150S	Silver Dark Dark Silver	1500	1333 x 200
0865C0150N	Nero Black	1500	1333 x 200

VASCHETTA UNIVERSALE OAK DARK BROWN
UNIVERSAL TRAY OAK DARK BROWN

A

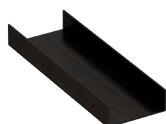

0865C0900

+

B

PORTA COLTELLI GHISA
KNIVES RACK DARK CAST IRON

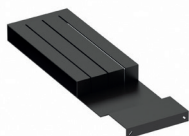

0865C0904G

PORTA OGGETTI GHISA
OBJECT HOLDERS CAST IRON

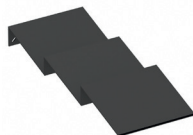

0865C0905G

PORTA SPEZIE GHISA
SPICE JARS HOLDER CAST IRON



0865C0906G

PORTA BARATTOLI GHISA
ARS HOLDER CAST IRON



0865C0907G

PORTA COLTELLI SILVER DARK
KNIVES RACK DARK SILVER

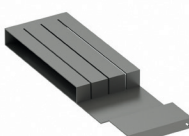

0865C0904S

PORTA OGGETTI SILVER DARK
OBJECT HOLDERS DARK SILVER

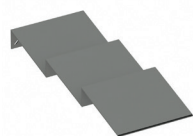

0865C0905S

PORTA SPEZIE SILVER DARK
SPICE JARS HOLDER DARK SILVER



0865C0906S

PORTA BARATTOLI SILVER DARK
ARS HOLDER DARK SILVER



0865C0907S

PORTA COLTELLI NERO
KNIVES RACK BLACK

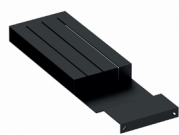

0865C0904N

PORTA OGGETTI NERO
OBJECT HOLDERS BLACK

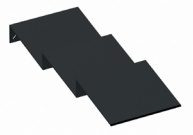

0865C0905N

PORTA SPEZIE NERO
SPICE JARS HOLDER BLACK



0865C0906N

PORTA BARATTOLI NERO
ARS HOLDER BLACK



0865C0907N

oppure

C

VASCHETTA ELETTTRIFICATA GHISA
ELECTRICAL TRAY CAST IRON



0865C0908G

VASCHETTA ELETTTRIFICATA SILVER DARK
ELECTRICAL TRAY DARK SILVER



0865C0908S

VASCHETTA ELETTTRIFICATA NERO
ELECTRICAL TRAY BLACK



0865C0908N

CANALE A INCASSO - MODULO 1800

LOW DEPTH BACK SECTION - MODULE 1800

 **A** + **B** oppure **C**

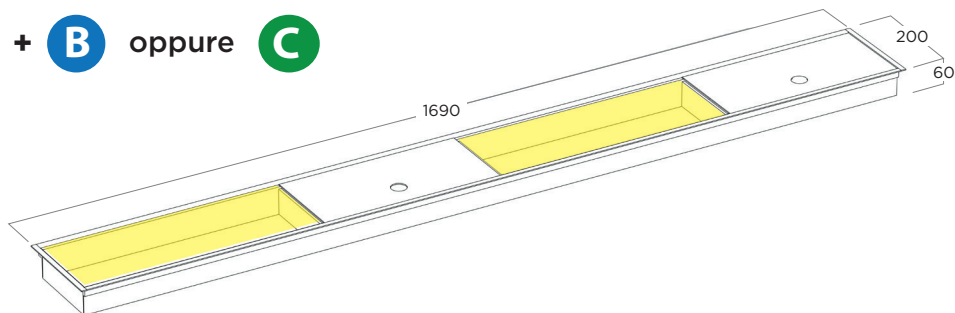

CODICE CODE	FINITURA FINISHING	MODULO (mm) MODULE (mm)	MISURE (mm) MEASURE (mm)
0865C0180G	Ghisa Cast Iron	1800	1690 x 200
0865C0180S	Silver Dark Dark Silver	1800	1690 x 200
0865C0180N	Nero Black	1800	1690 x 200

VASCETTA UNIVERSALE OAK DARK BROWN
UNIVERSAL TRAY OAK DARK BROWN

A

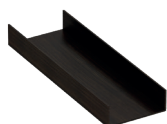

0865C0900

+

B

PORTA COLTELLI GHISA
KNIVES RACK DARK CAST IRON

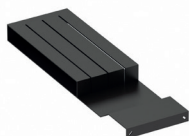

0865C0904G

PORTA OGGETTI GHISA
OBJECT HOLDERS CAST IRON

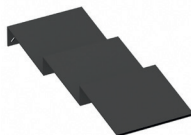

0865C0905G

PORTA SPEZIE GHISA
SPICE JARS HOLDER CAST IRON



0865C0906G

PORTA BARATTOLI GHISA
ARS HOLDER CAST IRON



0865C0907G

PORTA COLTELLI SILVER DARK
KNIVES RACK DARK SILVER

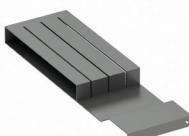

0865C0904S

PORTA OGGETTI SILVER DARK
OBJECT HOLDERS DARK SILVER

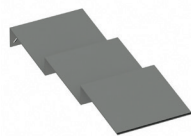

0865C0905S

PORTA SPEZIE SILVER DARK
SPICE JARS HOLDER DARK SILVER



0865C0906S

PORTA BARATTOLI SILVER DARK
ARS HOLDER DARK SILVER

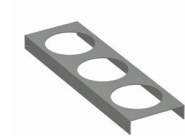

0865C0907S

PORTA COLTELLI NERO
KNIVES RACK BLACK

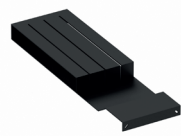

0865C0904N

PORTA OGGETTI NERO
OBJECT HOLDERS BLACK

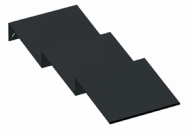

0865C0905N

PORTA SPEZIE NERO
SPICE JARS HOLDER BLACK



0865C0906N

PORTA BARATTOLI NERO
ARS HOLDER BLACK



0865C0907N

oppure

C

VASCETTA ELETTTRIFICATA GHISA
ELECTRICAL TRAY CAST IRON



0865C0908G

VASCETTA ELETTTRIFICATA SILVER DARK
ELECTRICAL TRAY DARK SILVER



0865C0908S

VASCETTA ELETTTRIFICATA NERO
ELECTRICAL TRAY BLACK



0865C0908N

CANALE A INCASSO - MODULO 2200 LOW DEPTH BACK SECTION - MODULE 2200

 **A** + **B** oppure **C**

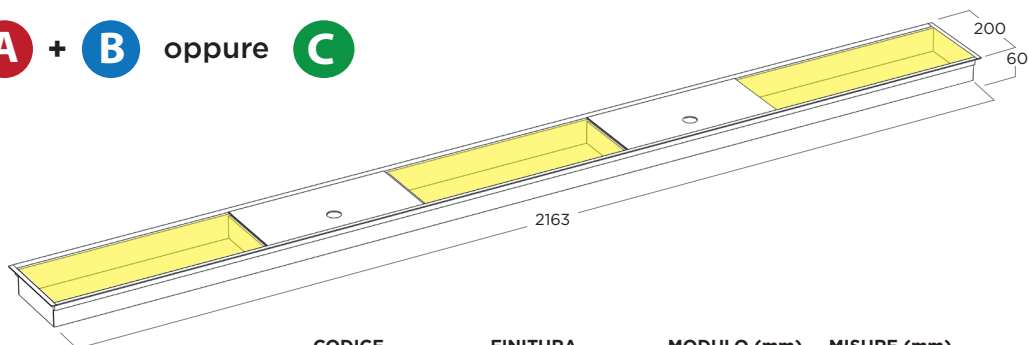

CODICE CODE	FINITURA FINISHING	MODULO (mm) MODULE (mm)	MISURE (mm) MEASURE (mm)
0865C0220G	Ghisa Cast Iron	2200	2163 x 200
0865C0220S	Silver Dark Dark Silver	2200	2163 x 200
0865C0220N	Nero Black	2200	2163 x 200

VASCHETTA UNIVERSALE OAK DARK BROWN
UNIVERSAL TRAY OAK DARK BROWN

A

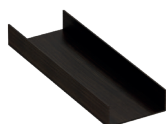

0865C0900

+

B

PORTA COLTELLI GHISA
KNIVES RACK DARK CAST IRON

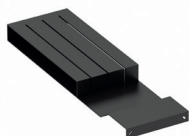

0865C0904G

PORTA OGGETTI GHISA
OBJECT HOLDERS CAST IRON

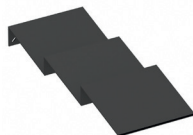

0865C0905G

PORTA SPEZIE GHISA
SPICE JARS HOLDER CAST IRON



0865C0906G

PORTA BARATTOLI GHISA
ARS HOLDER CAST IRON



0865C0907G

PORTA COLTELLI SILVER DARK
KNIVES RACK DARK SILVER

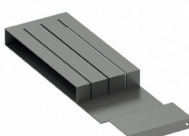

0865C0904S

PORTA OGGETTI SILVER DARK
OBJECT HOLDERS DARK SILVER

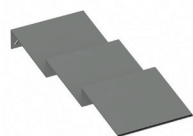

0865C0905S

PORTA SPEZIE SILVER DARK
SPICE JARS HOLDER DARK SILVER



0865C0906S

PORTA BARATTOLI SILVER DARK
ARS HOLDER DARK SILVER



0865C0907S

PORTA COLTELLI NERO
KNIVES RACK BLACK

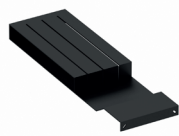

0865C0904N

PORTA OGGETTI NERO
OBJECT HOLDERS BLACK

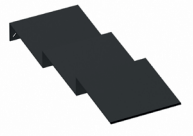

0865C0905N

PORTA SPEZIE NERO
SPICE JARS HOLDER BLACK



0865C0906N

PORTA BARATTOLI NERO
ARS HOLDER BLACK



0865C0907N

oppure

C

VASCHETTA ELETTTRIFICATA GHISA
ELECTRICAL TRAY CAST IRON



0865C0908G

VASCHETTA ELETTTRIFICATA SILVER DARK
ELECTRICAL TRAY DARK SILVER



0865C0908S

VASCHETTA ELETTTRIFICATA NERO
ELECTRICAL TRAY BLACK



0865C0908N

FRESATA NEL TOP
MILLING ON KITCHEN TOP

CANALE A INCASSO MODULO 900
LOW DEPTH BACK SECTION - MODULE 900

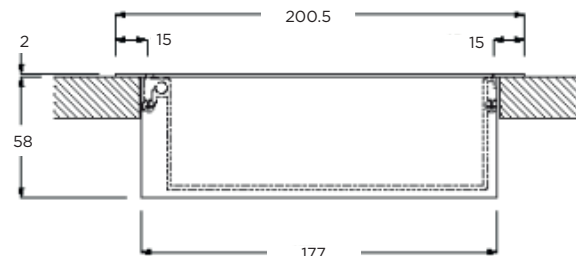
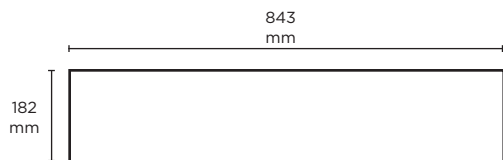

CANALE A INCASSO MODULO 1200
LOW DEPTH BACK SECTION - MODULE 1200

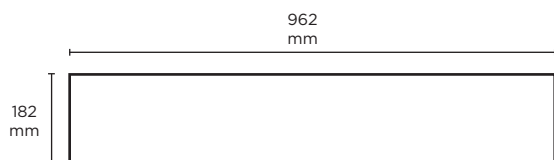

CANALE A INCASSO MODULO 1500
LOW DEPTH BACK SECTION - MODULE 1500

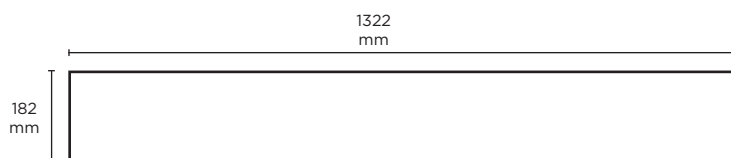

CANALE A INCASSO MODULO 1800
LOW DEPTH BACK SECTION - MODULE 1800

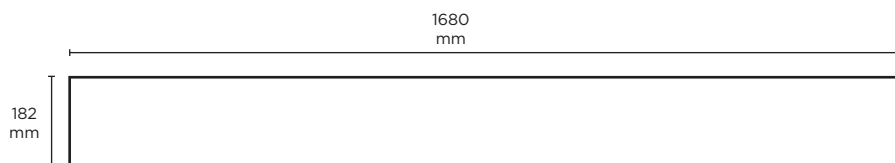

CANALE A INCASSO MODULO 2200
LOW DEPTH BACK SECTION - MODULE 2200

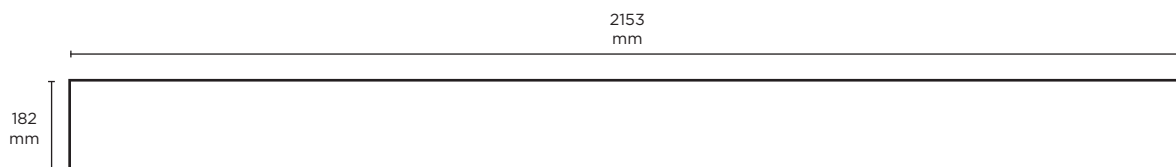

CANALE IN APPOGGIO

LAY-ON BACK SECTION

2 Materiali | *Materials*

4 Canale a incasso | *Low depth back section*

16 Canale in appoggio | *Lay-on back section*

24 Alzata in appoggio | *Lay-on double back section*

30 Finiture | *Finishings*



Disegnato per portare ordine sul top della cucina, il canale attrezzato in appoggio si può posizionare dove più si preferisce proprio perché è solo appoggiato sul top della cucina e fissato grazie ad uno speciale velcro che dà la possibilità di rimuoverlo ogni qualvolta ce ne sia il bisogno.

Proprio questa caratteristica di fissaggio, che evita lavorazioni sul top della cucina, lo rende particolarmente semplice da installare anche su una cucina già esistente. Equipaggiato con tutti gli accessori della linea BelNet 472, questo canale attrezzato è estremamente pratico e funzionale, portando carattere anche alle cucine più semplici.

Designed to bring order on the kitchen counter, the Lay-on Back Section stays where you place it, but can also be moved where you need it, thanks to the practical reusable fastener used to fix it to the counter top. Coming in four standard measures, and three standard colors the Lay-On Back Section can satisfy every cook's need for practicality and orderliness. Equipped with our BelNet 472 inserts, extremely versatile and practical the Lay-On Back Section is the perfect tool to accessorize the kitchen with tidiness and glamour.



CANALE IN APPOGGIO

LAY-ON BACK SECTION

Il fissaggio sul top avviene grazie ad uno speciale velcro che dà la possibilità di rimuoverlo ogni qualvolta ce ne sia il bisogno. Proprio questa caratteristica di fissaggio, che evita lavorazioni sul top della cucina, lo rende particolarmente semplice da installare anche su una cucina già esistente.

Thanks to the reusable fastener at the bottom, the Lay-On Back Section stays where you put it, but can be moved when and where you need it, without requiring any milling on the kitchen top.

FACILE DA INSTALLARE SUL TOP DELLA CUCINA

EASY TO INSTALL ON THE KITCHEN TOP

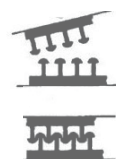

No Screws

No Holes

No Milled

POSSIBILITÀ DI PERSONALIZZAZIONE

CUSTOMIZATION AVAILABLE

Il canale in appoggio può essere prodotto in misure personalizzate, e può essere fornito anche senza fondo.

The Lay-On Back Section can be produced in customized measures, and it can be supplied also without bottom panel.

CANALE IN APPOGGIO - MODULO 900

LAY-ON BACK SECTION - MODULE 900

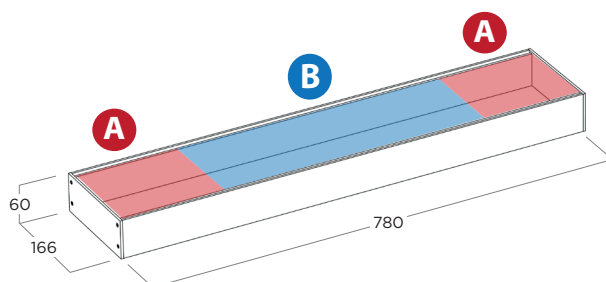

CODICE CODE	FINITURA FINISHING	MODULO (mm) MODULE (mm)	MISURE (mm) MEASURE (mm)
0865C0590G	Ghisa Cast Iron	900	780 x 166 x 60
0865C0590S	Silver Dark Dark Silver	900	780 x 166 x 60
0865C0590N	Nero Black	900	780 x 166 x 60

A

PORTA SPEZIE GHISA
SPICE JARS HOLDER CAST IRON

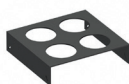

0865C0911G

VASSOIO GHISA
U TRAY CAST IRON



0865C0910G

PORTA SPEZIE SILVER DARK
SPICE JARS HOLDER DARK SILVER

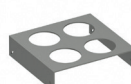

0865C0911S

VASSOIO SILVER DARK
U TRAY DARK SILVER

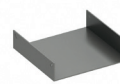

0865C0910S

PORTA SPEZIE NERO
SPICE JARS HOLDER BLACK



0865C0911N

VASSOIO NERO
U TRAY BLACK



0865C0910N

PORTA COLTELLI GHISA
KNIVES RACK DARK CAST IRON

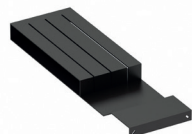

0865C0904G

PORTA OGGETTI GHISA
OBJECT HOLDERS CAST IRON

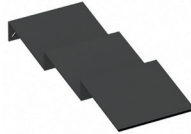

0865C0905G

PORTA SPEZIE GHISA
SPICE JARS HOLDER CAST IRON



0865C0906G

PORTA BARATTOLI GHISA
ARS HOLDER CAST IRON



0865C0907G

B

PORTA COLTELLI SILVER DARK
KNIVES RACK DARK SILVER

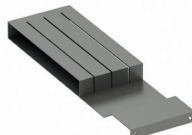

0865C0904S

PORTA OGGETTI SILVER DARK
OBJECT HOLDERS DARK SILVER

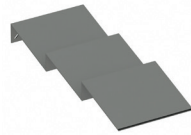

0865C0905S

PORTA SPEZIE SILVER DARK
SPICE JARS HOLDER DARK SILVER



0865C0906S

PORTA BARATTOLI SILVER DARK
ARS HOLDER DARK SILVER



0865C0907S

PORTA COLTELLI NERO
KNIVES RACK BLACK

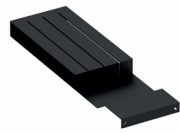

0865C0904N

PORTA OGGETTI NERO
OBJECT HOLDERS BLACK

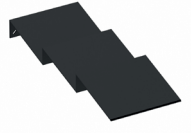

0865C0905N

PORTA SPEZIE NERO
SPICE JARS HOLDER BLACK



0865C0906N

PORTA BARATTOLI NERO
ARS HOLDER BLACK



0865C0907N

CANALE IN APPOGGIO - MODULO 1200

LAY-ON BACK SECTION - MODULE 1200

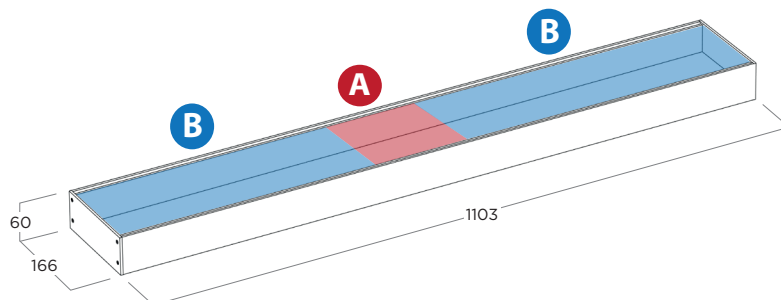

CODICE CODE	FINITURA FINISHING	MODULO (mm) MODULE (mm)	MISURE (mm) MEASURE (mm)
0865C0620G	Ghisa Cast Iron	1200	1103 x 166 x 60
0865C0620S	Silver Dark Dark Silver	1200	1103 x 166 x 60
0865C0620N	Nero Black	1200	1103 x 166 x 60

A

PORTA SPEZIE GHISA
SPICE JARS HOLDER CAST IRON

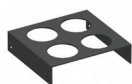

0865C0911G

VASSOIO GHISA
U TRAY CAST IRON

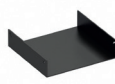

0865C0910G

PORTA SPEZIE SILVER DARK
SPICE JARS HOLDER DARK SILVER

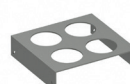

0865C0911S

VASSOIO SILVER DARK
U TRAY DARK SILVER

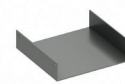

0865C0910S

PORTA SPEZIE NERO
SPICE JARS HOLDER BLACK



0865C0911N

VASSOIO NERO
U TRAY BLACK



0865C0910N

B

PORTA COLTELLI GHISA
KNIVES RACK DARK CAST IRON

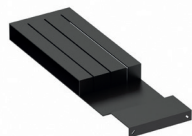

0865C0904G

PORTA OGGETTI GHISA
OBJECT HOLDERS CAST IRON

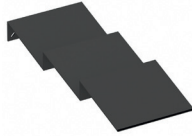

0865C0905G

PORTA SPEZIE GHISA
SPICE JARS HOLDER CAST IRON



0865C0906G

PORTA BARATTOLI GHISA
ARS HOLDER CAST IRON



0865C0907G

PORTA COLTELLI SILVER DARK
KNIVES RACK DARK SILVER

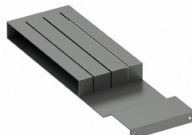

0865C0904S

PORTA OGGETTI SILVER DARK
OBJECT HOLDERS DARK SILVER

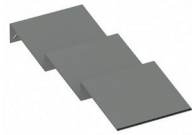

0865C0905S

PORTA SPEZIE SILVER DARK
SPICE JARS HOLDER DARK SILVER



0865C0906S

PORTA BARATTOLI SILVER DARK
ARS HOLDER DARK SILVER



0865C0907S

PORTA COLTELLI NERO
KNIVES RACK BLACK

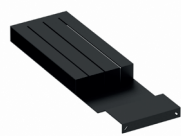

0865C0904N

PORTA OGGETTI NERO
OBJECT HOLDERS BLACK

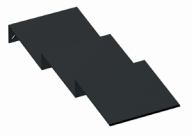

0865C0905N

PORTA SPEZIE NERO
SPICE JARS HOLDER BLACK



0865C0906N

PORTA BARATTOLI NERO
ARS HOLDER BLACK



0865C0907N

CANALE IN APPOGGIO - MODULO 1500 LAY-ON BACK SECTION - MODULE 1500

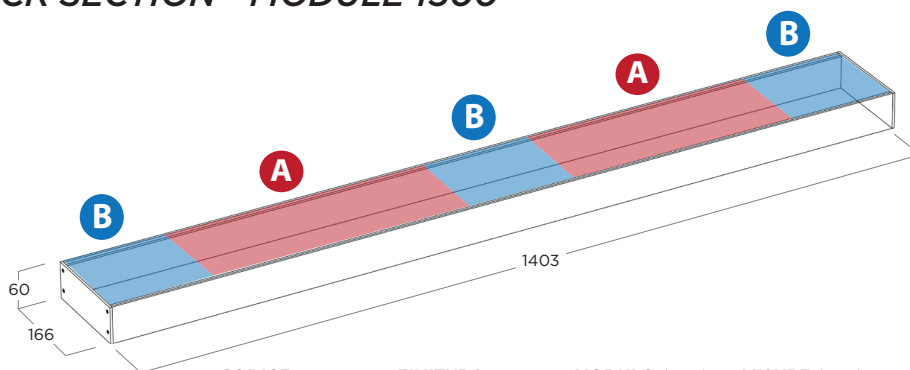

CODICE CODE	FINITURA FINISHING	MODULO (mm) MODULE (mm)	MISURE (mm) MEASURE (mm)
0865C0650G	Ghisa Cast Iron	1500	1403 x 166 x 60
0865C0650S	Silver Dark Dark Silver	1500	1403 x 166 x 60
0865C0650N	Nero Black	1500	1403 x 166 x 60

A

PORTA SPEZIE GHISA
SPICE JARS HOLDER CAST IRON



0865C0911G

PORTA SPEZIE NERO
SPICE JARS HOLDER BLACK



0865C0911N

PORTA COLTELLI GHISA
KNIVES RACK DARK CAST IRON

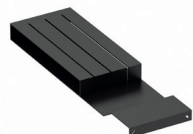

0865C0904G

PORTA COLTELLI SILVER DARK
KNIVES RACK DARK SILVER

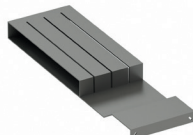

0865C0904S

PORTA COLTELLI NERO
KNIVES RACK BLACK

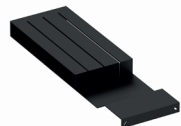

0865C0904N

VASSOIO GHISA
U TRAY CAST IRON



0865C0910G

VASSOIO NERO
U TRAY BLACK



0865C0910N

PORTA OGGETTI GHISA
OBJECT HOLDERS CAST IRON

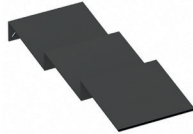

0865C0905G

PORTA OGGETTI SILVER DARK
OBJECT HOLDERS DARK SILVER

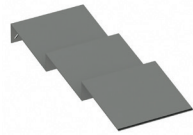

0865C0905S

PORTA OGGETTI NERO
OBJECT HOLDERS BLACK

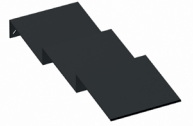

0865C0905N

PORTA SPEZIE SILVER DARK
SPICE JARS HOLDER DARK SILVER

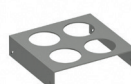

0865C0911S

PORTA SPEZIE GHISA
SPICE JARS HOLDER CAST IRON



0865C0906G

PORTA SPEZIE SILVER DARK
SPICE JARS HOLDER DARK SILVER



0865C0906S

PORTA SPEZIE NERO
SPICE JARS HOLDER BLACK



0865C0906N

VASSOIO SILVER DARK
U TRAY DARK SILVER

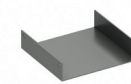

0865C0910S

PORTA BARATTOLI GHISA
ARS HOLDER CAST IRON



0865C0907G

PORTA BARATTOLI SILVER DARK
ARS HOLDER DARK SILVER



0865C0907S

PORTA BARATTOLI NERO
ARS HOLDER BLACK



0865C0907N

B

CANALE IN APPOGGIO - MODULO 1800 LAY-ON BACK SECTION - MODULE 1800

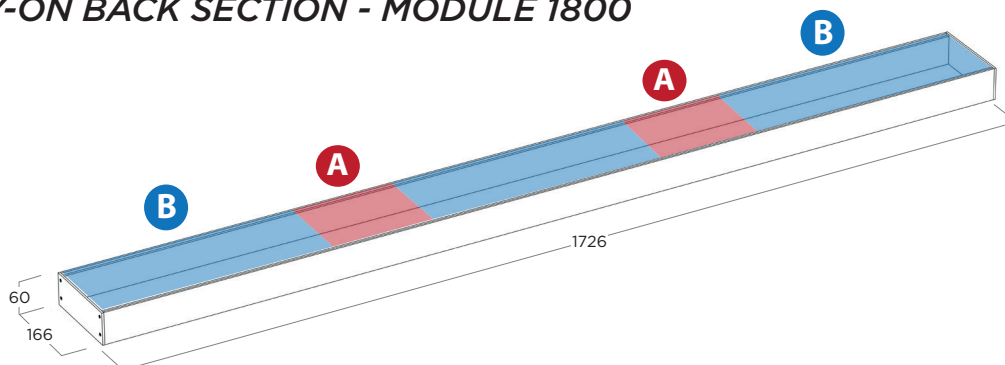

CODICE CODE	FINITURA FINISHING	MODULO (mm) MODULE (mm)	MISURE (mm) MEASURE (mm)
0865C0680G	Ghisa Cast Iron	1800	1726 x 166 x 60
0865C0680S	Silver Dark Dark Silver	1800	1726 x 166 x 60
0865C0680N	Nero Black	1800	1726 x 166 x 60

A

PORTA SPEZIE GHISA
SPICE JARS HOLDER CAST IRON

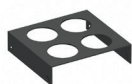

0865C0911G

VASSOIO GHISA
U TRAY CAST IRON



0865C0910G

PORTA SPEZIE SILVER DARK
SPICE JARS HOLDER DARK SILVER

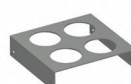

0865C0911S

VASSOIO SILVER DARK
U TRAY DARK SILVER

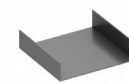

0865C0910S

PORTA SPEZIE NERO
SPICE JARS HOLDER BLACK



0865C0911N

VASSOIO NERO
U TRAY BLACK



0865C0910N

B

PORTA COLTELLI GHISA
KNIVES RACK DARK CAST IRON

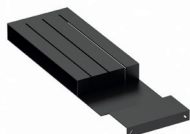

0865C0904G

PORTA OGGETTI GHISA
OBJECT HOLDERS CAST IRON

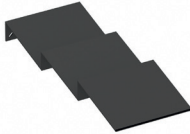

0865C0905G

PORTA SPEZIE GHISA
SPICE JARS HOLDER CAST IRON



0865C0906G

PORTA BARATTOLI GHISA
ARS HOLDER CAST IRON



0865C0907G

PORTA COLTELLI SILVER DARK
KNIVES RACK DARK SILVER

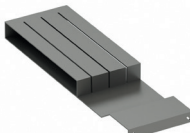

0865C0904S

PORTA OGGETTI SILVER DARK
OBJECT HOLDERS DARK SILVER

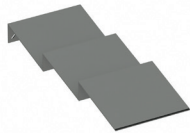

0865C0905S

PORTA SPEZIE SILVER DARK
SPICE JARS HOLDER DARK SILVER



0865C0906S

PORTA BARATTOLI SILVER DARK
ARS HOLDER DARK SILVER



0865C0907S

PORTA COLTELLI NERO
KNIVES RACK BLACK

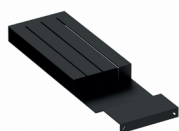

0865C0904N

PORTA OGGETTI NERO
OBJECT HOLDERS BLACK

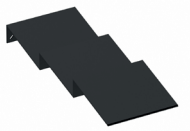

0865C0905N

PORTA SPEZIE NERO
SPICE JARS HOLDER BLACK



0865C0906N

PORTA BARATTOLI NERO
ARS HOLDER BLACK



0865C0907N

ALZATA IN APPOGGIO

LAY-ON DOUBLE BACK SECTION

2 Materiali | *Materials*

4 Canale a incasso | *Low depth back section*

16 Canale in appoggio | *Lay-on back section*

24 Alzata in appoggio | *Lay-on double back section*

30 Finiture | *Finishings*



L'alzata in appoggio non è altro che l'evoluzione del canale in appoggio sviluppato in altezza su due livelli di contenimento. Anche in questa situazione il fissaggio sul top avviene tramite lo speciale velcro che consente di poter rimuovere l'alzata in ogni momento, ma al contempo dona una stabilità perfetta quando fissata, senza necessità di lavorazioni sul top della cucina. Disponibile in tre lunghezze standard, si adatta perfettamente a tutti i tipi di cucina, sia nelle cucine a muro che nelle isole centro stanza. Equipaggiato con tutti gli accessori della linea BelNet 472, questo canale attrezzato è estremamente pratico e funzionale, portando carattere anche alle cucine più semplici.

Evolution of the Lay-on Back Section, the Lay-On Double Back Section finds more storage space on the kitchen counter by expanding vertically. Using the reusable fastener to be kept in place, but moved when needed, the Lay-On Double brings dynamism to the cooking area. Coming in three standard measures, and three standard colors this back section can satisfy every cook's need for tidiness and functionality. Equipped with our BelNet 472 inserts, extremely versatile and practical the Lay-On Double Back Section is the perfect tool to accessorize the kitchen with order and style.

■ ALZATA IN APPOGGIO

LAY-ON DOUBLE BACK SECTION

Il fissaggio sul top avviene grazie ad uno speciale velcro che dà la possibilità di rimuoverlo ogni qualvolta ce ne sia il bisogno. Proprio questa caratteristica di fissaggio, che evita lavorazioni sul top della cucina, lo rende particolarmente semplice da installare anche su una cucina già esistente.

Thanks to the reusable fastener at the bottom, the Lay-On Double Back Section stays where your put it, but can be moved when and where you need it, without requiring any milling on the kitchen top.

FACILE DA INSTALLARE SUL TOP DELLA CUCINA

EASY TO INSTALL ON THE KITCHEN TOP

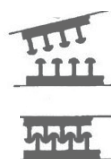

No Screws

No Holes

No Milled

POSSIBILITÀ DI PERSONALIZZAZIONE

CUSTOMIZATION AVAILABLE

L'alzata in appoggio può essere prodotta in misure personalizzate.

The Lay-On Double Back Section can be produced in customized measures.

ALZATA IN APPOGGIO - MODULO 900

LAY-ON DOUBLE BACK SECTION - MODULE 900

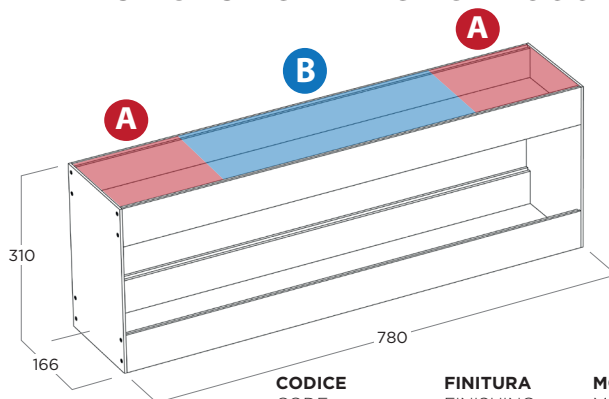

CODICE CODE	FINITURA FINISHING	MODULO (mm) MODULE (mm)	MISURE (mm) MEASURE (mm)
0865C0595G	Ghisa Cast Iron	900	780 x 166 x 310
0865C0595S	Silver Dark Dark Silver	900	780 x 166 x 310
0865C0595N	Nero Black	900	780 x 166 x 310

PORTA SPEZIE GHISA
SPICE JARS HOLDER CAST IRON

VASSOIO GHISA
U TRAY CAST IRON

PORTA SPEZIE SILVER DARK
SPICE JARS HOLDER DARK SILVER

VASSOIO SILVER DARK
U TRAY DARK SILVER

A

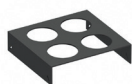

0865C0911G



0865C0910G

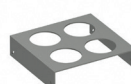

0865C0911S

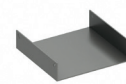

0865C0910S

PORTA SPEZIE NERO
SPICE JARS HOLDER BLACK

VASSOIO NERO
U TRAY BLACK



0865C0911N



0865C0910N

PORTA COLTELLI GHISA
KNIVES RACK DARK CAST IRON

PORTA OGGETTI GHISA
OBJECT HOLDERS CAST IRON

PORTA SPEZIE GHISA
SPICE JARS HOLDER CAST IRON

PORTA BARATTOLI GHISA
ARS HOLDER CAST IRON

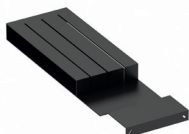

0865C0904G

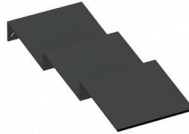

0865C0905G



0865C0906G



0865C0907G

PORTA COLTELLI SILVER DARK
KNIVES RACK DARK SILVER

PORTA OGGETTI SILVER DARK
OBJECT HOLDERS DARK SILVER

PORTA SPEZIE SILVER DARK
SPICE JARS HOLDER DARK SILVER

PORTA BARATTOLI SILVER DARK
ARS HOLDER DARK SILVER

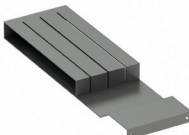

0865C0904S

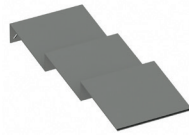

0865C0905S



0865C0906S



0865C0907S

PORTA COLTELLI NERO
KNIVES RACK BLACK

PORTA OGGETTI NERO
OBJECT HOLDERS BLACK

PORTA SPEZIE NERO
SPICE JARS HOLDER BLACK

PORTA BARATTOLI NERO
ARS HOLDER BLACK

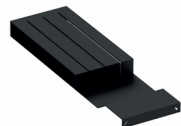

0865C0904N

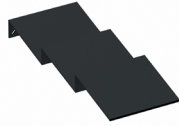

0865C0905N



0865C0906N



0865C0907N

B

ALZATA IN APPOGGIO - MODULO 1200

LAY-ON DOUBLE BACK SECTION - MODULE 1200

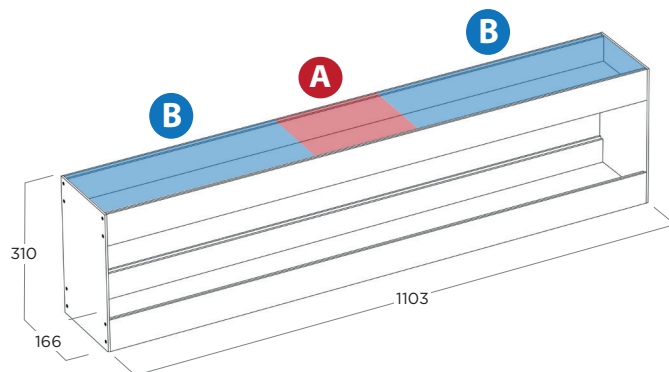

CODICE CODE	FINITURA FINISHING	MODULO (mm) MODULE (mm)	MISURE (mm) MEASURE (mm)
0865C0625G	Ghisa Cast Iron	1200	1103 x 166 x 310
0865C0625S	Silver Dark Dark Silver	1200	1103 x 166 x 310
0865C0625N	Nero Black	1200	1103 x 166 x 310

PORTA SPEZIE GHISA
SPICE JARS HOLDER CAST IRON

VASSOIO GHISA
U TRAY CAST IRON

PORTA SPEZIE SILVER DARK
SPICE JARS HOLDER DARK SILVER

VASSOIO SILVER DARK
U TRAY DARK SILVER

A

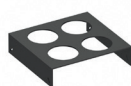

0865C0911G

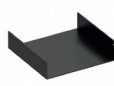

0865C0910G

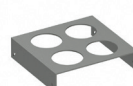

0865C0911S

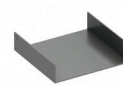

0865C0910S

PORTA SPEZIE NERO
SPICE JARS HOLDER BLACK

VASSOIO NERO
U TRAY BLACK



0865C0911N



0865C0910N

PORTA COLTELLI GHISA
KNIVES RACK DARK CAST IRON

PORTA OGGETTI GHISA
OBJECT HOLDERS CAST IRON

PORTA SPEZIE GHISA
SPICE JARS HOLDER CAST IRON

PORTA BARATTOLI GHISA
ARS HOLDER CAST IRON

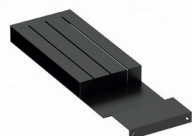

0865C0904G

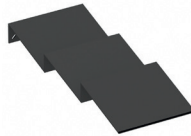

0865C0905G



0865C0906G



0865C0907G

PORTA COLTELLI SILVER DARK
KNIVES RACK DARK SILVER

PORTA OGGETTI SILVER DARK
OBJECT HOLDERS DARK SILVER

PORTA SPEZIE SILVER DARK
SPICE JARS HOLDER DARK SILVER

PORTA BARATTOLI SILVER DARK
ARS HOLDER DARK SILVER

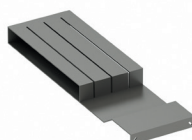

0865C0904S

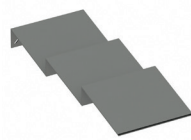

0865C0905S



0865C0906S



0865C0907S

PORTA COLTELLI NERO
KNIVES RACK BLACK

PORTA OGGETTI NERO
OBJECT HOLDERS BLACK

PORTA SPEZIE NERO
SPICE JARS HOLDER BLACK

PORTA BARATTOLI NERO
ARS HOLDER BLACK

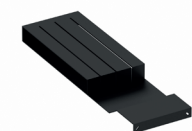

0865C0904N

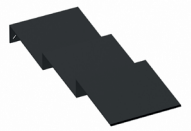

0865C0905N



0865C0906N



0865C0907N

B

ALZATA IN APPOGGIO - MODULO 1500

LAY-ON DOUBLE BACK SECTION - MODULE 1500

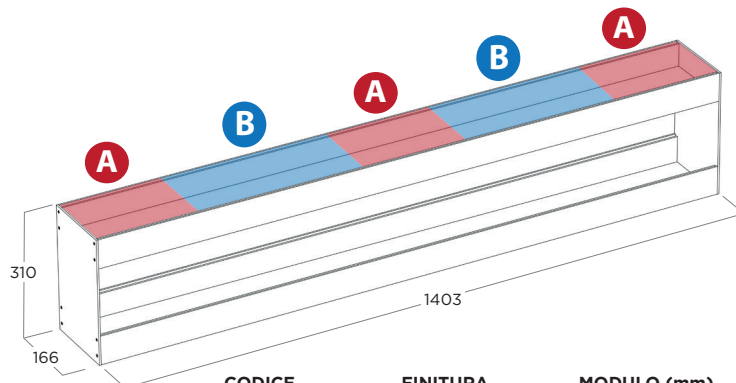

CODICE CODE	FINITURA FINISHING	MODULO (mm) MODULE (mm)	MISURE (mm) MEASURE (mm)
0865C0655G	Ghisa Cast Iron	1500	1403 x 166 x 310
0865C0655S	Silver Dark Dark Silver	1500	1403 x 166 x 310
0865C0655N	Nero Black	1500	1403 x 166 x 310

PORTA SPEZIE GHISA
SPICE JARS HOLDER CAST IRON

VASSOIO GHISA
U TRAY CAST IRON

PORTA SPEZIE SILVER DARK
SPICE JARS HOLDER DARK SILVER

VASSOIO SILVER DARK
U TRAY DARK SILVER

A

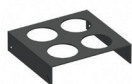

0865C0911G



0865C0910G

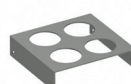

0865C0911S

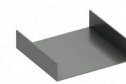

0865C0910S

PORTA SPEZIE NERO
SPICE JARS HOLDER BLACK

VASSOIO NERO
U TRAY BLACK



0865C0911N



0865C0910N

PORTA COLTELLI GHISA
KNIVES RACK DARK CAST IRON

PORTA OGGETTI GHISA
OBJECT HOLDERS CAST IRON

PORTA SPEZIE GHISA
SPICE JARS HOLDER CAST IRON

PORTA BARATTOLI GHISA
ARS HOLDER CAST IRON

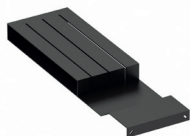

0865C0904G

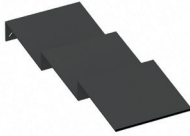

0865C0905G



0865C0906G



0865C0907G

PORTA COLTELLI SILVER DARK
KNIVES RACK DARK SILVER

PORTA OGGETTI SILVER DARK
OBJECT HOLDERS DARK SILVER

PORTA SPEZIE SILVER DARK
SPICE JARS HOLDER DARK SILVER

PORTA BARATTOLI SILVER DARK
ARS HOLDER DARK SILVER

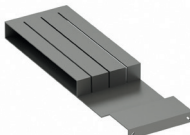

0865C0904S

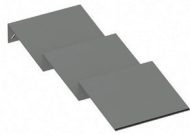

0865C0905S



0865C0906S



0865C0907S

PORTA COLTELLI NERO
KNIVES RACK BLACK

PORTA OGGETTI NERO
OBJECT HOLDERS BLACK

PORTA SPEZIE NERO
SPICE JARS HOLDER BLACK

PORTA BARATTOLI NERO
ARS HOLDER BLACK

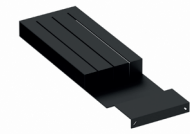

0865C0904N

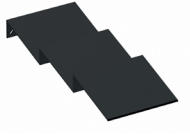

0865C0905N



0865C0906N



0865C0907N

B

FINITURE

FINISHINGS

2 Materiali | *Materials*

4 Canale a incasso | *Low depth back section*

16 Canale in appoggio | *Lay-on back section*

24 Alzata in appoggio | *Lay-on double back section*

30 Finiture | *Finishings*

** Gli esempi di colore e materiale hanno valore indicativo.*
** The color and material references in this page are only indicative.*

LEGNI IMPIALLACCIATI SU STRATIFICATO

VENEERED WOOD ON COMPACT HPL

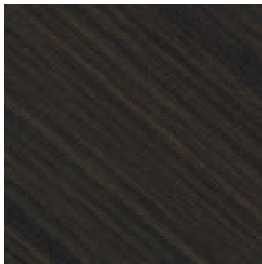

OAK DARK BROWN
DARK BROWN OAK

ALLUMINIO

ALUMINIUM



SILVER DARK
DARK SILVER

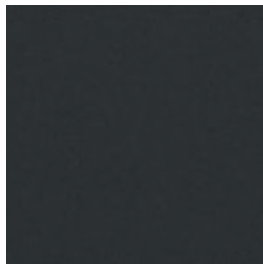

GHISA
CAST IRON



ALLUMINIO NERO
BLACK ALUMINIUM

GRUPPOLUBE



BOISERIE HI-LINE

2023

La **Boiserie Hi-line** è un rivestimento funzionale.

Un elemento che dona al tuo arredamento un grande impatto estetico e ti permette di attrezzare la parete, personalizzandola secondo le tue esigenze. I suoi elementi modulari permettono di avere a portata di mano tutto ciò che ti serve. Le mensole ed i vari accessori, danno anche la possibilità di tenere a vista elementi decorativi e di design, valorizzando la tua composizione anche dal punto di vista estetico.

La **Boiserie**, inoltre, può essere arricchita di luci led e prese elettriche, senza la necessità di dover per forza canalizzare la parete per l'impianto elettrico.

Boiserie Hi-line is a functional covering.

An element that allow to have a great aesthetic impact and also to equip the wall, customizing it according to your needs. Its modular elements are thought for having everything you need on hand. The shelves and accessories give the possibility to keep in sights decorative and design elements, enphatizing the furniture also from aesthetical point of view.

Furthermore, the **Boiserie** can be enriched with LED lights and electrical sockets, without modify the electrical system.







La **Boiserie Hi-line**, permette di personalizzare e trasformare non solo la zona cucina ma tutti gli ambienti della casa rendendo gli spazi più eleganti e funzionali.

Questa soluzione può diventare una scelta valida anche negli interni dallo stile più contemporaneo.

The **Boiserie Hi Line** allows you to customize not only the kitchen area but also all house spaces, making them more elegant and functional.

This solution maybe become a valid choice for contemporary style interiors.

Categorie

categories

SOVRATOP OVERTOP



Soluzione inserita tra pensile e top.
Possibilità di variante con luce LED
nel profilo superiore.

Solution between kitchen cabinet
and top. Its possible to choose the
variant with LED light in the upper
profile.

ANGOLO CORNER



Modulo per soluzioni personalizzate
adattabili anche nelle situazioni in
cui sono presenti pareti con angolo.

Module for customized solutions,
adaptable for situations with
corner walls.

PARETE WALL



Pannellature attrezzate da terra,
pensate per trovare continuità con le
modularità della cucina.

Panels equipped from the ground,
designed to find continuity with the
kitchen's modularity.

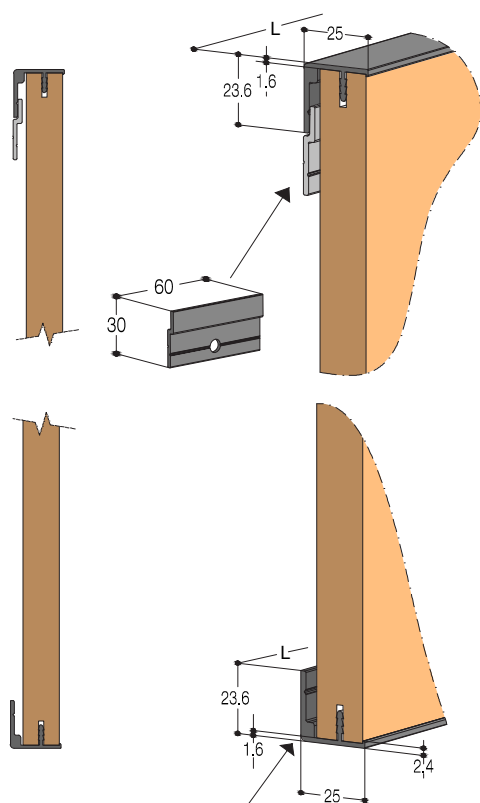

Profilo con fori asolati per fissaggio a parete
Profile with slotted holes for wall fixing

PROFILO CHIUSURA SUPERIORE/INFERIORE TOP/BOTTOM CLOSING PROFILE

Lunghezza max di taglio 3000 mm
Max cutting length 3000 mm

FINITURA Finish	A/V*	CODICE Code
■ Nero black	A	086BHL01AL11
■ Titanio titanium	A	086BHL01AL12

- Profilo di chiusura superiore - compresi N.2 piastrini per aggancio a muro ogni 50 cm;
- Top closing profile - including 2 wall attachment plates every 50 cm;

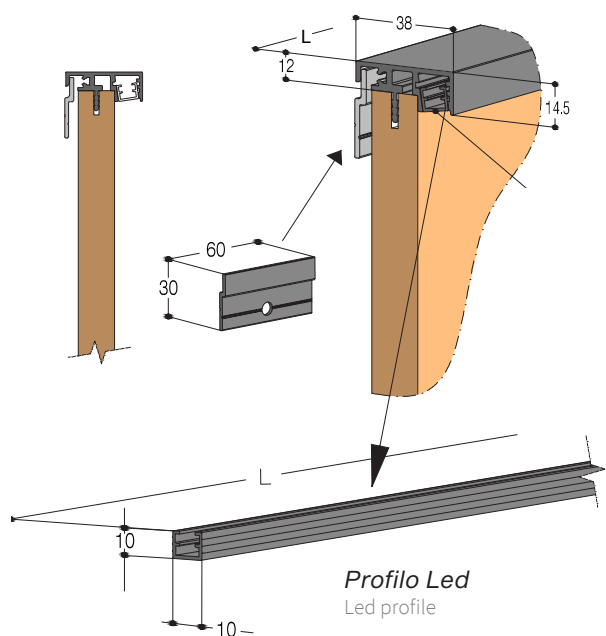

Profilo Led
Led profile

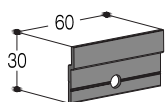

Kit piastrini fissaggio a parete
inclusi con il profilo Boiserie
(n.2 piastrini Mtl.)
Wall fixing plate kit
included with the Boiserie profile
(n.2 plates Mtl.)

PROFILO CHIUSURA SUPERIORE CON LED UPPER CLOSING PROFILE WITH LED

Lunghezza max di taglio 3000 mm
Max cutting length 3000 mm

FINITURA Finish	A/V*	CODICE Code
■ Nero black	A	086BHL06AL11
■ Titanio titanium	A	086BHL06AL12

- Profilo superiore e barra LED - Dual Color 3000/4000k compreso - NON INSTALLATA; assorbimento 11,4 Watt/M
- Upper profile and LED bar - Dual Color 3000/4000k included - but NOT INSTALLED; absorption 11.4 Watt/M

*A/V: A=ANODIZZATO V=VERNICIATO
ANODIZED PAINTED

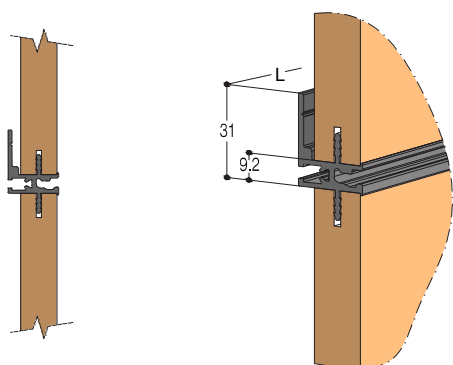

PROFILO INTERMEDIO PER PANNELLI LEGNO
INTERMEDIATE PROFILE FOR WOOD PANELS

Lunghezza max di taglio 3000 mm
Max cutting length 3000 mm

FINITURA Finish	A/V*	CODICE Code
■ Nero black	A	086BHL03AL11
■ Titanio titanium	A	086BHL03AL12

- Profilo intermedio CON SPINA SOPRA/SOTTO;
- Intermediate profile WITH PLUG ABOVE/BELOW,

Profilo con fori asolati per fissaggio a parete
Profile with slotted holes for wall fixing

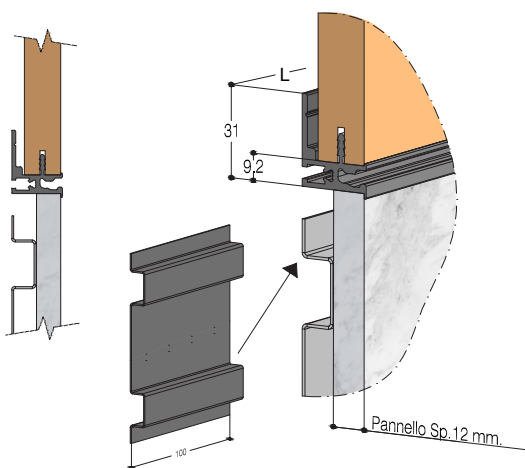

PROFILO INTERMEDIO PER PANNELLI IN COMPOSITO
INTERMEDIATE PROFILE FOR COMPOSITE PANELS

Lunghezza max di taglio 3000 mm
Max cutting length 3000 mm

FINITURA Finish	A/V*	CODICE Code
■ Nero black	A	086BHL04AL11
■ Titanio titanium	A	086BHL04AL12

- Profilo intermedio CON SPINA SOPRA- SENZA SPINA SOTTO;
- Intermediate profile WITH PLUG ABOVE - WITHOUT PLUG BELOW;

Profilo con fori asolati per fissaggio a parete
Profile with slotted holes for wall fixing

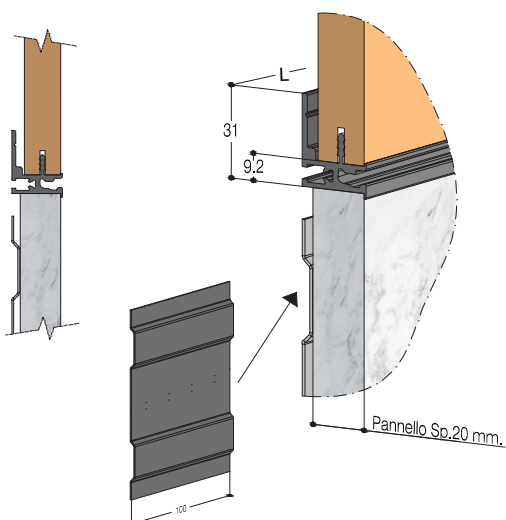

N.B.: Solo per boiserie sopratop
Note: Only for boiserie worktop

*A/V: A=ANODIZZATO V=VERNICIATO
ANODIZED PAINTED

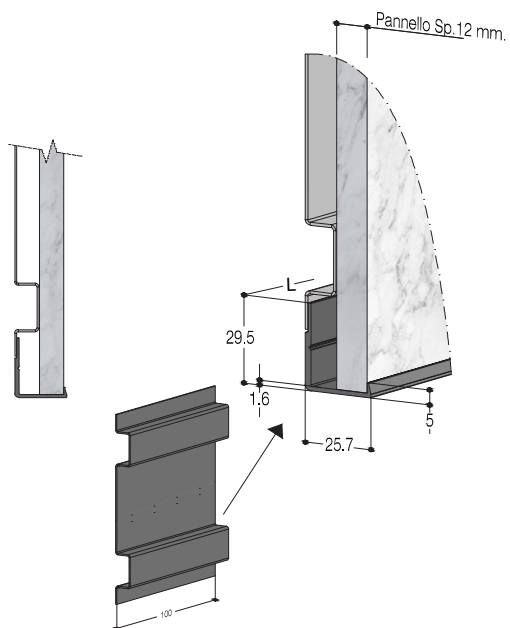

PROFILO CHIUSURA INF. PER MATERIALI COMPOSITI
BOTTOM CLOSING PROFILE FOR COMPOSITE MATERIALS

Lunghezza max di taglio 3200 mm
Max cutting length 3200 mm

FINITURA Finish	A/V*	CODICE Code
■ Nero black	A	086BHL02AL11
■ Titanio titanium	A	086BHL02AL12

- Profilo inferiore SENZA SPINA;
- Bottom profile WITHOUT PLUG

N.B.: Solo per boiserie sopratop
Note: Only for boiserie worktop

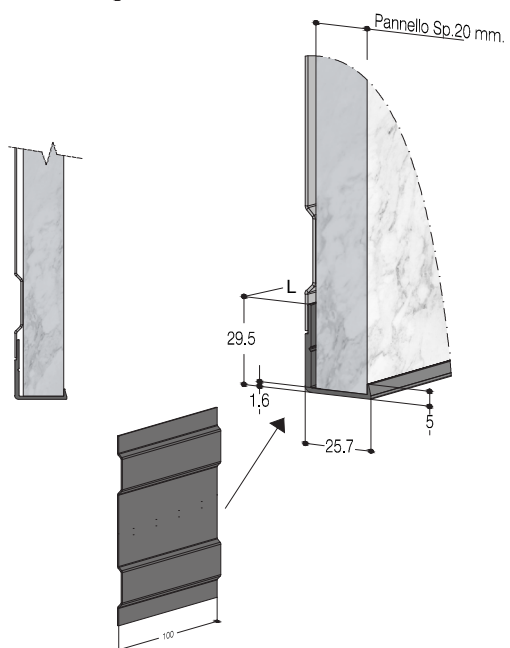

Lamiere compensazione Compensating sheets

N.B.: per pannello sp.20

Note: for panel th.20

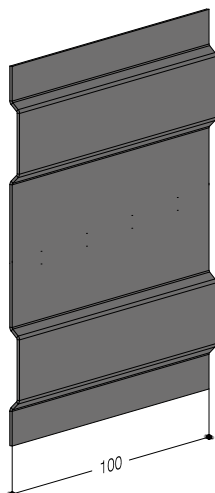

COPPIA DI COMPENSATORI PER PANNELLI SP.12-20 MM PAIR OF COMPENSATORS FOR PANELS THICKNESS 12-20 MM

FINITURA Finish	A/V*	CODICE Code
■ Grezzo raw	A	086BHL11

**N.B.: Considerare una coppia di compensatori ogni metro di
composizione**

Note: Consider a pair of compensators for every meter of composition

N.B.: per pannello sp.12

Note: for panel th.12

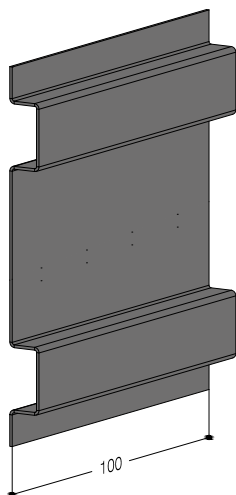

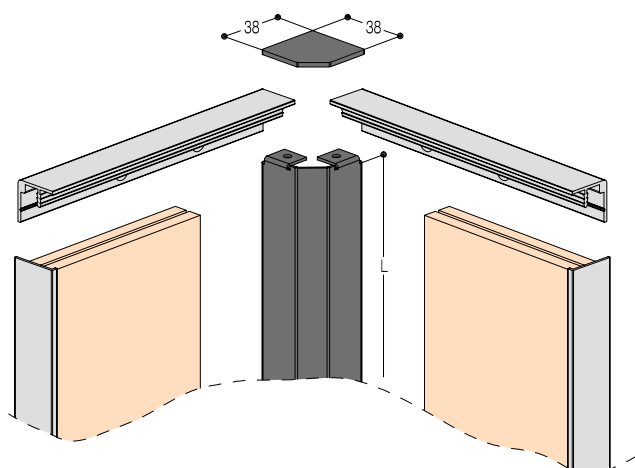

PROFILO ANGOLARE C/PIASTRINO DI CHIUSURA
ANGULAR PROFILE WITH CLOSING COVER

Dimensioni piastrino L.38xP.38 mm
Cover dimension L.38xP.38 mm.

FINITURA Finish	A/V*	CODICE Code
■ Nero black	A	086BHL08AL11
■ Titanio titanium	A	086BHL08AL12

- Profilo angolo con piastrino di chiusura;
- Corner profile with closing plate;

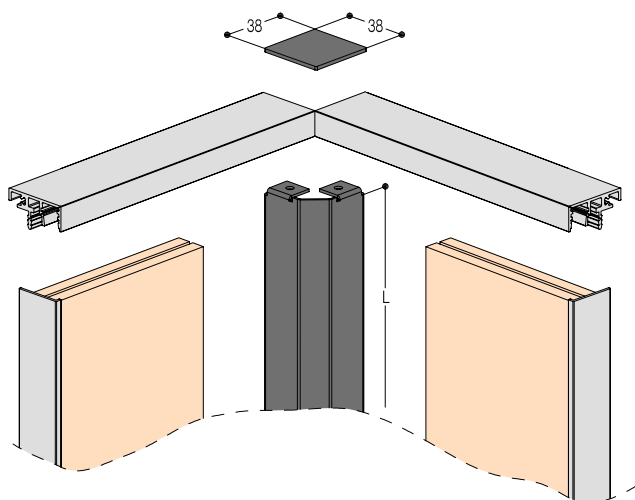

PROFILO ANGOLARE C/PIASTRINO DI CHIUSURA PER LED
ANGULAR PROFILE WITH CLOSING COVER FOR LED

Dimensioni piastrino L.38xP.38 mm
Cover dimension L.38xP.38 mm.

FINITURA Finish	A/V*	CODICE Code
■ Nero black	A	086BHL09AL11
■ Titanio titanium	A	086BHL09AL12

- Profilo angolo con piastrino di chiusura;
- Corner profile with closing plate;

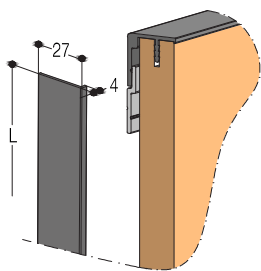

PROFILO INTERMEDIO DI CHIUSURA VERTICALE
VERTICAL INTERMEDIATE CLOSING PROFILE

FINITURA Finish	A/V'	CODICE Code
■ Nero black	A	086BHL07AL11
■ Titanio titanium	A	086BHL07AL12

N.B.: Se si supera la lunghezza massima dei pannelli e si vogliono accostare piu' moduli per allungare la composizione tra questi vanno sempre inseriti i profili intermedi in accosto.

Note: If you exceed the maximum length of the panels and you want to combine several modules to lengthen the composition between them the intermediate profiles must always be inserted side by side.

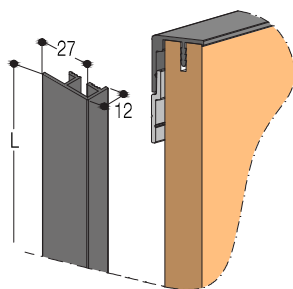

PROFILO DI CHIUSURA LATERALE L 12
LATERAL CLOSING W 12 PROFILE

FINITURA Finish	A/V'	CODICE Code
■ Nero black	A	086BHL12AL11
■ Titanio titanium	A	086BHL12AL12

N.B.: Profilo laterale obbligatorio ad inizio/fine composizione
Note: Mandatory side profile at the start/end of the composition

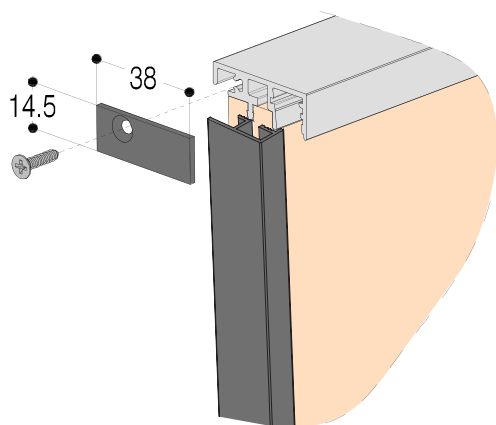

COPPIA TAPPI CHIUSURA (DX/SX) PER BARRA BOISERIE C/LED
CAPS PAIR OF CLOSURES (R/L) FOR WOODEN BAR W/LED

FINITURA Finish	A/V'	CODICE Code
■ Nero black	A	086BHL10AL11
■ Titanio titanium	A	086BHL10AL12

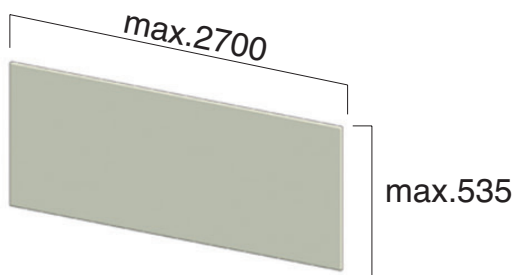

PANNELLO CON FRESATA SUPERIORE E INFERIORE
(Utilizzabile su tutte le tipologie di Boiserie)
PANEL WITH UPPER AND LOWER MILLING
(Can be used on all types of Boiserie)

TIPOLOGIA

Type

Melaminico melamine Tablet
Melaminico melamine Immagina
Melaminico melamine Unica
Laminato come top laminate same as worktop
Laccato UV UV lacquered
Fenix

CODICE

Code

086BHP01
086BHP01
086BHP01
086BHP01
086BHP01
086BHP01

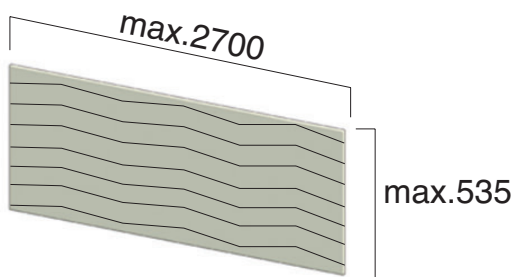

PANNELLO CON FRESATA SUP. E INF. VENATURA VERTICALE
(Utilizzabile su tutte le tipologie di Boiserie)
PANEL WITH UPPER AND LOWER MILLED VERTICAL GRAIN
(Can be used on all types of Boiserie)

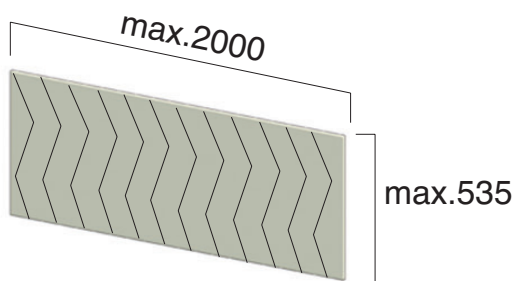

TIPOLOGIA

Type

Melaminico melamine Tablet
Melaminico melamine Immagina
Melaminico melamine Unica

CODICE

Code

086BHP03
086BHP03
086BHP03

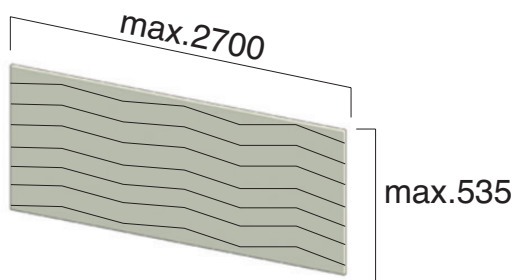

PANNELLO CON FRESATA SUP. E INF. IMPIALLACCIATO VENATURA ORIZZONTALE
(Utilizzabile su tutte le tipologie di Boiserie)
PANEL WITH MILLING UPPER AND LOWER HORIZONTAL GRAIN VENEERED
(Can be used on all types of Boiserie)

TIPOLOGIA Type	CODICE Code	FASCIA A Category A	FASCIA B Category B	FASCIA C Category C
Wood	086BHP04			
Impiallacciato veneered Clover	086BHP04			
Impiallacciato veneered Flavour	086BHP04			
Impiallacciato veneered Luna	086BHP04			
Impiallacciato veneered Oltre	086BHP04			

N.B.: Costi riferiti al MQ
Note: Cost referred per squadre meter

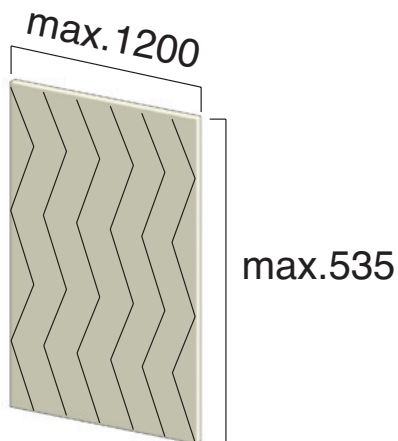

PANNELLO CON FRESATA SUP. E INF. IMPIALLACCIATO VENATURA VERTICALE
(Utilizzabile su tutte le tipologie di Boiserie)
PANEL WITH UPPER AND LOWER MILLED VEENERED VERTICAL GRAIN
(Can be used on all types of Boiserie)

TIPOLOGIA Type	CODICE Code	FASCIA A Category A	FASCIA B Category B	FASCIA C Category C
Wood	086BHP05			
Impiallacciato veneered Clover	086BHP05			
Impiallacciato veneered Flavour	086BHP05			
Impiallacciato veneered Luna	086BHP05			
Impiallacciato veneered Oltre	086BHP05			

N.B.: Costi riferiti al MQ
Note: Cost referred per squadre meter

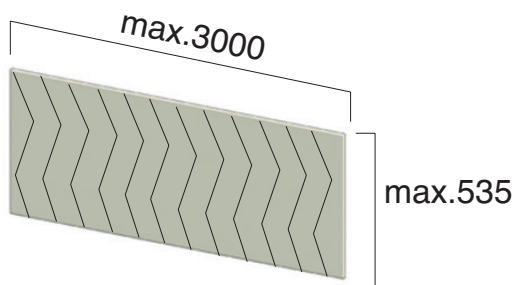

PANNELLO CON FRESATA SUPERIORE E INFERIORE
(Utilizzabile su tutte le tipologie di Boiserie)
PANEL WITH UPPER AND LOWER MILLED VERTICAL GRAIN
(Can be used on all types of Boiserie)

TIPOLOGIA
Type
Mathera

CODICE
Code
086BHP07

N.B.: solo per finiture selce
Note: only for flint finishes

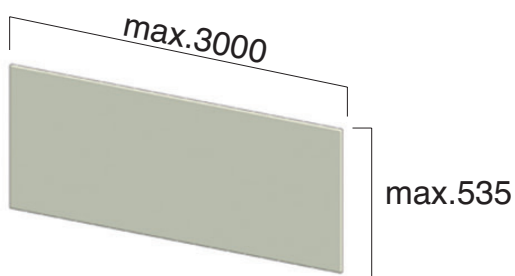

PANNELLO CON FRESATA SUP. E INF. VENATURA ORIZZONTALE
(Utilizzabile su tutte le tipologie di Boiserie)
PANEL WITH UPPER AND LOWER MILLED HORIZONTAL GRAIN
(Can be used on all types of Boiserie)

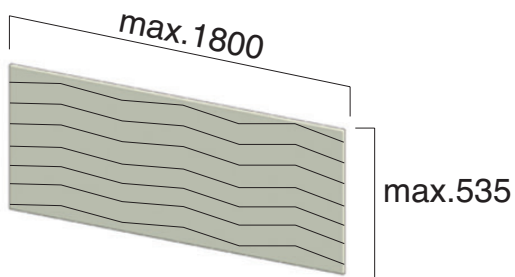

TIPOLOGIA
Type
Mathera

CODICE
Code
086BHP06

N.B.: solo per finiture selce
Note: only for flint finishes

Pannelli Panels

Durante la fase di progettazione bisogna tener presente sia del limite dimensionale del pannello (altezza e larghezza max.) che in caso di finiture materiche, dell'orientamento della venatura.

During the design phase, it is necessary to keep in mind both the panel dimensional limit (height and width max.) and in the case of finishes material, the grain orientation (vertical or horizontal).

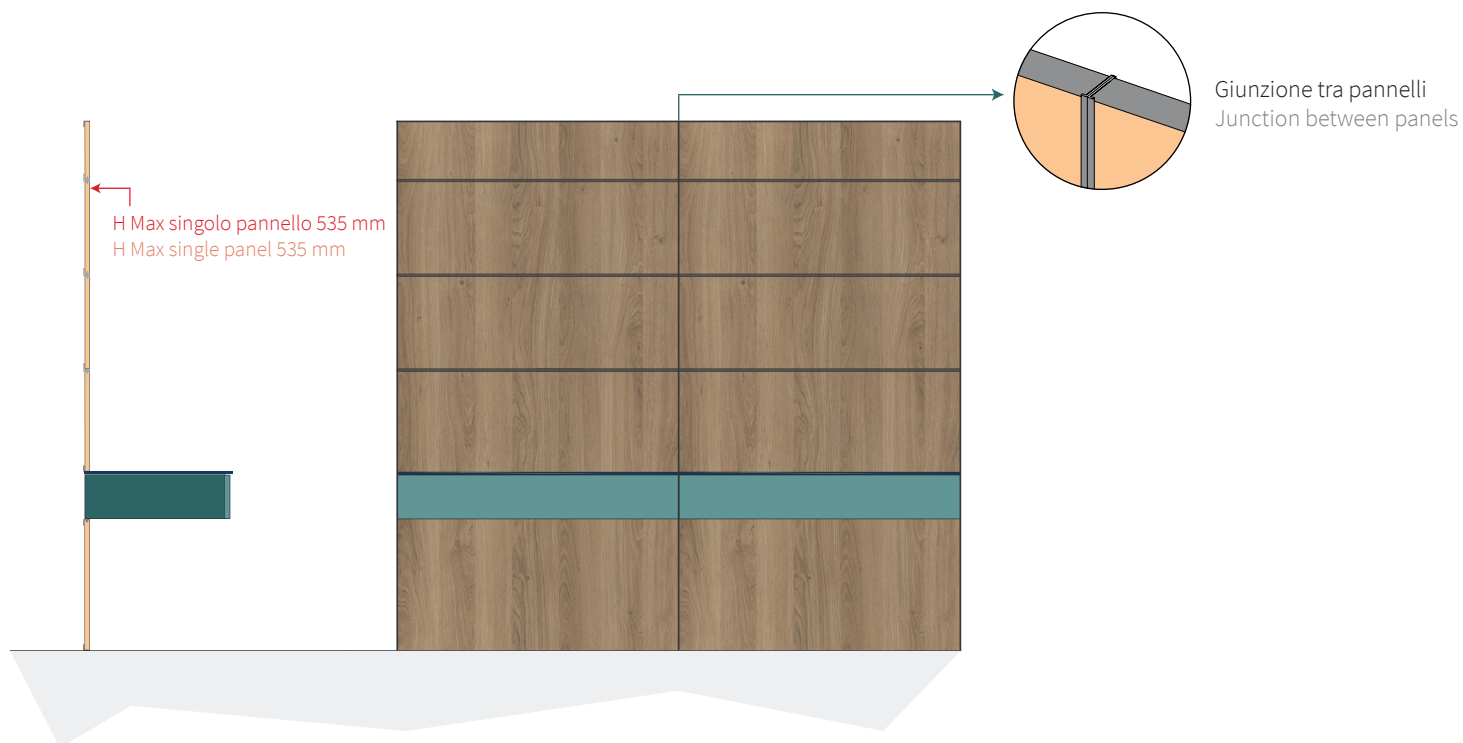

Pannelli in composito solo elemento inferiore per composizione sopratop
Composite panels only lower element for lay on worktop composition

N.B.: Solo per la tipologia di composizione tra base e top e' possibile inserire il pannello inferiore in composito nelle tipologie riportate di seguito.

Note: Only for the type of composition between base unit and worktop it is possible to insert the composite lower panel in the types listed below.

KERLITE	TKRS12
KOROS	TKSS12
GRES LAMINAM	TLNS12
INFINITY	TINS12
DEKTON	TDES20
OKITE	094022
QUARZI	TQRS20
SILESTONE	TSIS20
STRATIFICATO HPL	THPLS13

Finiture Pannelli

Panels finishes

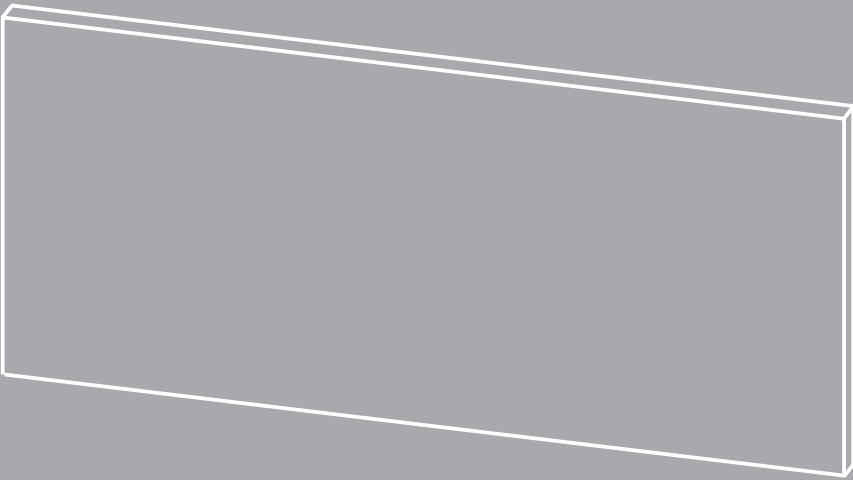

***COLORI IMPIALLACCIATI MODELLO OLTRE FASCIA A**
OLTRE MODEL VENEERED COLOURS CATEGORY A



***COLORI IMPIALLACCIATI MODELLO CLOVER FASCIA A**
CLOVER MODEL VENEERED COLOURS CATEGORY A



***COLORI IMPIALLACCIATI MODELLO CLOVER FASCIA B**
CLOVER MODEL VENEERED COLOURS CATEGORY B

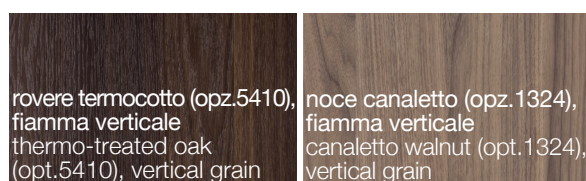

*** N.B.: Possibilita' di venatura sia verticale che orizzontale, per i codici vedi pag.17**
Note: Possibility of both vertical and horizontal grain, for codes see page 17

COLORI IMPIALLACCIATI MODELLO LUNA FASCIA A
LUNA MODEL VENEERED COLOURS CATEGORY A

 <p>rovere bianco (opz.5429), fiamma orizzontale white oak (opt.5429), horizontal grain</p>	 <p>rovere grigio reale (opz.5432), fiamma orizzontale royal grey oak (opt.5432), horizontal grain</p>	 <p>rovere grigio traffico (opz.5431), fiamma orizzontale traffic grey oak (opt.5431), horizontal grain</p>	 <p>rovere carbon (opz.5434) fiamma orizzontale carbon oak (opt.5434), horizontal grain</p>
 <p>rovere natur (opz.5440) fiamma orizzontale natur oak (opt.5440), horizontal grain</p>	 <p>rovere lino (opz.5430) fiamma orizzontale linen oak (opt.5430), horizontal grain</p>	 <p>rovere moresco (opz.5433) fiamma orizzontale moresco oak (opt.5433), horizontal grain</p>	

COLORI IMPIALLACCIATI MODELLO LUNA FASCIA B
LUNA MODEL VENEERED COLOURS CATEGORY B

 <p>noce canaletto (opz.1331) fiamma orizzontale canaletto walnut (opt.1331), horizontal grain</p>
--

***COLORI IMPIALLACCIATI MODELLO IMMAGINA WOOD FASCIA B**
IMMAGINA WOOD MODEL VENEERED COLOURS CATEGORY B

 <p>rovere naturale (opz.5442), fiamma verticale natural oak (opt.5442), vertical grain</p>	 <p>rovere grey (opz.5443), fiamma verticale grey oak (opt.5443), vertical grain</p>	 <p>rovere moscato (opz.5444), fiamma verticale muscat oak (opt.5444), vertical grain</p>	 <p>rovere fumè (opz.5445), fiamma verticale smoked oak (opt.5445), vertical grain</p>
 <p>rovere bianco (opz.5441), fiamma verticale white oak (opt.5441), vertical grain</p>	 <p>rovere nero (opz.5446), fiamma verticale black oak (opt.5446), vertical grain</p>		

*** N.B.: Possibilita' di venatura sia verticale che orizzontale, per i codici vedi pag.17**
Note: Possibility of both vertical and horizontal grain, for codes see page 17

Finiture Pannelli

Panels finishes

*COLORI IMPIALLACCIATI MODELLO FLAVOUR FASCIA A

FLAVOUR MODEL VENEERED COLOURS CATEGORY A



*COLORI IMPIALLACCIATI MODELLO FLAVOUR FASCIA B

FLAVOUR MODEL VENEERED COLOURS CATEGORY B



COLORI IMPIALLACCIATI MODELLO CLOVER FASCIA C

CLOVER MODEL VENEERED COLOURS CATEGORY C

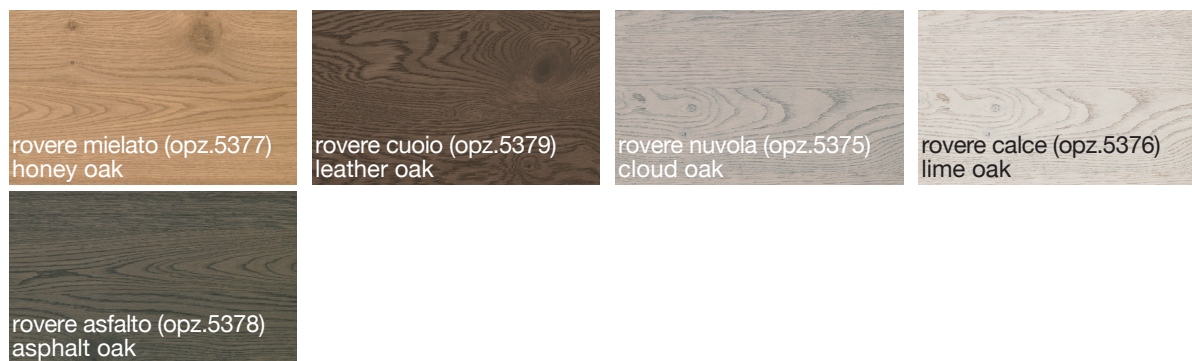

COLORI MODELLO IMMAGINA MATHERA FINTURA AREIA

IMMAGINA MATHERA MODEL COLOURS AREIA FINISH

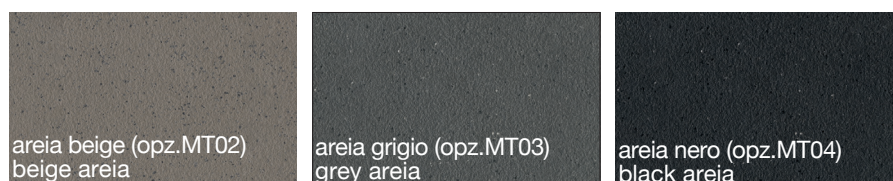

COLORI MODELLO IMMAGINA MATHERA FINTURA GIPSO

IMMAGINA MATHERA MODEL COLOURS GIPSO FINISH

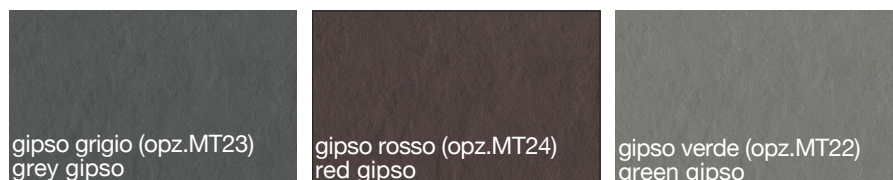

*COLORI MODELLO IMMAGINA MATHERA FINTURA SELCE VENATURE VERTICALI

IMMAGINA MATHERA MODEL COLOURS SELCE FINISH WITH VERTICAL GRAIN

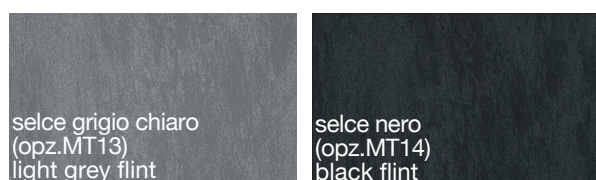

* **N.B.:** Possibilita' di venatura sia verticale che orizzontale, per i codici vedi pag.17-18

Note: Possibility of both vertical and horizontal grain, for codes see page 17-18

Finiture Pannelli

Panels finishes

COLORI LACCATI UV

UV LACQUERED COLOURS

<p>bianco opaco (opz.7405) matt white bianco lucido (opz.7406) glossy white</p>	<p>antracite opaco (opz.9558) matt anthracite antracite lucido (opz.9559) glossy anthracite</p>	<p>desert opaco (opz.8941) matt deser desert lucido (opz.8942) glossy desert</p>	<p>nero opaco (opz.7895) matt black nero lucido (opz.7896) glossy black</p>
<p>blu cobalto opaco (opz.8383) matt cobalt blue</p>	<p>bianco neve opaco (opz.7407) matt snow white</p>	<p>verde malga opaco (opz.8477) matt alpine green</p>	<p>polvere opaco (opz.9529) matt dust polvere lucido (opz.9530) glossy dust</p>
<p>rosso velvet opaco (opz.8168) matt velvet red</p>	<p>grigio minerale opaco (opz.9523) matt mineral gray grigio minerale lucido (opz.9524) glossy mineral gray</p>	<p>beige colorado opaco (opz.7777) matt colorado beige beige colorado lucido (opz.7778) glossy colorado beige</p>	<p>rosso cammeo opaco (opz.8160) matt cammeo red rosso cammeo lucido (opz.8164) glossy cammeo red</p>
<p>giallo cadmio opaco (opz.8255) matt cadmio yellow</p>	<p>verde nilo opaco (opz.8475) matt nilo green</p>		

COLORI FENIX

FENIX COLOURS

<p>bianco caldo (opz.0032) warm white</p>	<p>castoro (opz.0717) beaver</p>	<p>fumo (opz.0718) smoke</p>	<p>nero (opz.0720) black</p>
<p>grigio bromo (opz.0724) bromine grey</p>	<p>bronzo doha (opz.2629) doha bronze</p>	<p>beige arizona (opz.0748) arizona beige</p>	<p>cacao orinoco (opz.0749) orinoco cocoa</p>
<p>verde commodoro (opz.0750) commodoro green</p>	<p>rosso jaipur (opz.0751) jaipur red</p>	<p>grigio antrim (opz.0752) antrim grey</p>	<p>bianco dover (opz.0757) dover white</p>
<p>grigio efeso (opz.0725) ephesus grey</p>			

Finiture Pannelli

Panels finishes

COLORI MELAMINICI

MELAMINE COLOURS







<p>cansiglio terra bruciata (opz.1562), venatura verticale cansiglio scorched earth (opt.1562), vertical grain</p>	<p>pagos nuvola (opz.1567) phagos cloud</p>	<p>pagos bianco (opz.1566) phagos white</p>	<p>rovere perla (opz.5314) oak pearl</p>
<p>pagos kapok (opz.1560) phagos kapok</p>	<p>pagos vulcano (opz.1568) phagos volcano</p>	<p>salix brown (opz.1521) brown salix</p>	<p>abies moka (opz.4410) moka abies</p>
<p>abies bistro (opz.4411) bistro abies</p>	<p>rovere grigio chiaro (opz.5328) light oak gray</p>	<p>rovere grafite (opz.5327) graphite oak</p>	<p>rovere chiaro (opz.5325) light oak</p>
<p>rovere duna (opz.5326) dune oak</p>	<p>castagno bianco (opz.3055) white chestnut</p>	<p>rovere luna (opz.5316) moon oak</p>	<p>rovere venere (opz.5315) venus oak</p>
<p>rovere arizona (opz.5317) arizona oak</p>	<p>rovere dark (opz.5318) dark oak</p>	<p>frassino lava (opz.2408) lava ash</p>	<p>frassino sabbia (opz.2406) sand ash</p>
<p>frassino pietra (opz.2407) stone ash</p>	<p>noce brown (opz.2371) brown walnut</p>	<p>rovere tabià (opz.5309) tabià oak</p>	<p>rovere ortisei (opz.5305) ortisei oak</p>
<p>peltro (opz.9666) pewter</p>	<p>ottone chiaro (opz.7707) light brass</p>	<p>rame brunito (opz.8868) burnished copper</p>	<p>rigatino verticale arena (opz.9647V) arena vertical reed effect</p>
<p>rigatino orizzontale arena (opz.9647O) arena horizontal reed effect</p>	<p>rigatino verticale laguna (opz.9648V) lagoon vertical reed effect</p>	<p>rigatino orizzontale laguna (opz.9648O) lagoon horizontal reed effect</p>	<p>verde marino (opz.8402N) sea green</p>
<p>nichel (opz.9660) nickel</p>	<p>platino (opz.9661) platinum</p>	<p>oxide (opz.8871) oxide</p>	<p>pietra grey (opz.9642) stone grey</p>
<p>bianco assoluto (opz.7450) absolute white</p>	<p>ecru (opz.9641) ecru</p>	<p>antracite (opz.9643) anthracite</p>	<p>dove grey (opz.8971) grey dove</p>

Finiture Pannelli

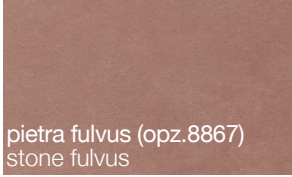
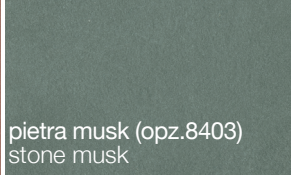
Panels finishes

COLORI MELAMINICI

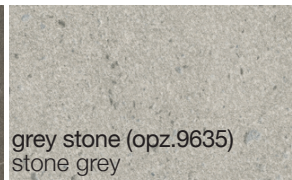
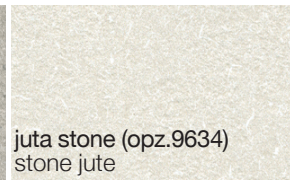
MELAMINE COLOURS

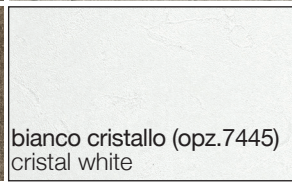
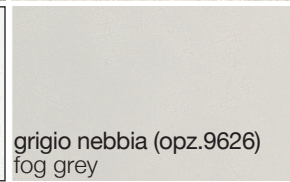
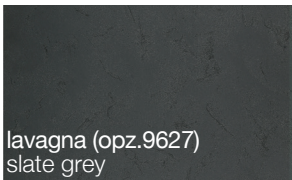
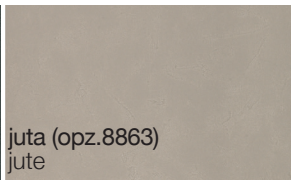
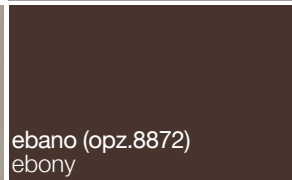
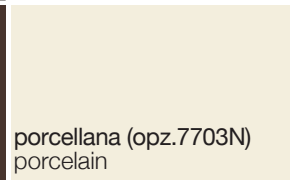
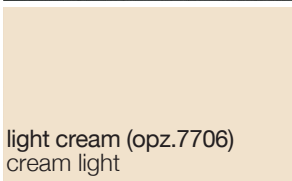
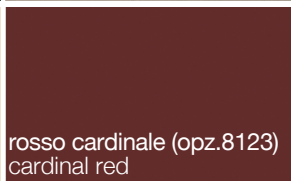
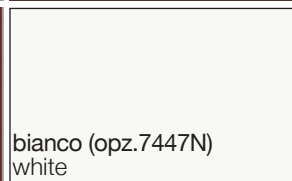
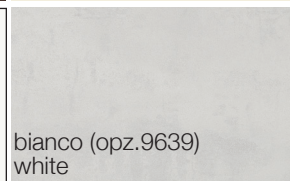
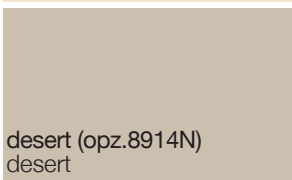
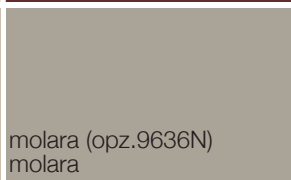
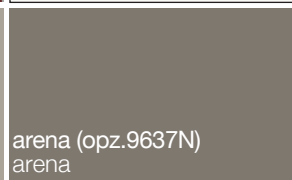
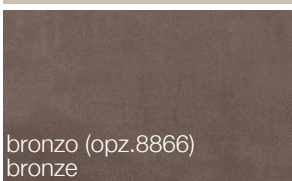
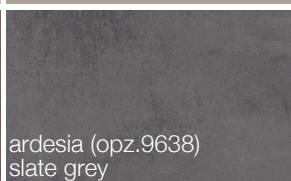
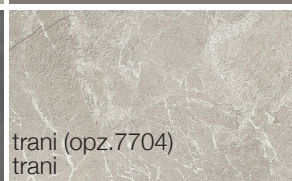
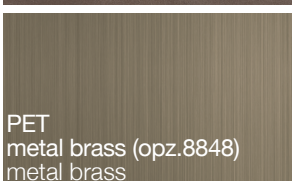
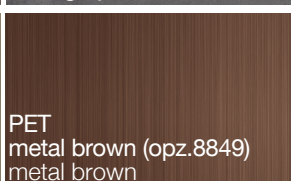
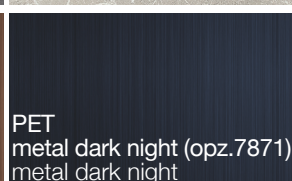
 <p>pietra fulvus (opz.8867) stone fulvus</p>	 <p>pietra musk (opz.8403) stone musk</p>	 <p>grigio chiaro (opz.9640) clear grey</p>	 <p>salix grey (opz.1522) grey salix</p>
 <p>marmo white yule (opz.9645) yule white marble</p>	 <p>marmo venato grigio (opz.8870) grey veined marble</p>	 <p>grey stone (opz.9635) stone grey</p>	 <p>juta stone (opz.9634) stone jute</p>
 <p>bronze stone (opz.8869) stone bronze</p>	 <p>kea (opz.9646) kea</p>	 <p>bianco cristallo (opz.7445) cristal white</p>	 <p>grigio nebbia (opz.9626) fog grey</p>
 <p>lavagna (opz.9627) slate grey</p>	 <p>juta (opz.8863) jute</p>	 <p>ebano (opz.8872) ebony</p>	 <p>porcellana (opz.7703N) porcelain</p>
 <p>light cream (opz.7706) cream light</p>	 <p>rosso cardinale (opz.8123) cardinal red</p>	 <p>bianco (opz.7447N) white</p>	 <p>bianco (opz.9639) white</p>
 <p>desert (opz.8914N) desert</p>	 <p>molara (opz.9636N) molara</p>	 <p>arena (opz.9637N) arena</p>	
 <p>bronzo (opz.8866) bronze</p>	 <p>ardesia (opz.9638) slate grey</p>	 <p>trani (opz.7704) trani</p>	
 <p>PET metal brass (opz.8848) metal brass</p>	 <p>PET metal brown (opz.8849) metal brown</p>	 <p>PET metal dark night (opz.7871) metal dark night</p>	

COLORI LAMINATO COME TOP
LAMINATE COLOURS AS WORKTOP

 <p>alabastro finitura mn (opz.6014) alabaster with mn finish</p>	 <p>dark finitura mn (opz.6133) dark with mn finish</p>	 <p>calacatta finitura mn (opz.6019) calacatta with mn finish</p>	 <p>bianco lasa finitura mn (opz.6152) lasa white with mn finish</p>
 <p>grigio cemento finitura touch (opz.786) cement grey touch finish</p>	 <p>bianco alpino finitura touch (opz.309C) alpine-white with touch finish</p>	 <p>peltro finitura ossidata (opz.L934) pewter with oxidized finish</p>	 <p>ferro finitura ossidata (opz.L933) iron with oxidized finish</p>
 <p>imperial black finitura ker (opz.3452) black imperial with ker finish</p>	 <p>bianco zara finitura ker (opz.3451) zara white with ker finish</p>	 <p>bianco finitura velvet (opz.800) white with velvet finish</p>	 <p>stone white finitura real (opz.SH09) white stone with real finish</p>
 <p>old grey finitura urban (opz.LM12) old grey with urban finish</p>	 <p>old dark finitura urban (opz.LM13) old dark with urban finish</p>	 <p>old black finitura urban (opz.LM14) old black with urban finish</p>	 <p>old white finitura urban (opz.LM11) old white with urban finish</p>
 <p>kaspio argento finitura flash (opz.6090) silver kaspio with flash finish</p>	 <p>kaspio oro finitura flash (opz.6089) gold kaspio with flash finish</p>	 <p>brass finitura flash (opz.5025) brass with flash finish</p>	 <p>lusema finitura luna (opz.3366) lusema with luna finish</p>
 <p>esterel finitura wraky (opz.811) esterel with wraky finish</p>	 <p>malta visone vintage finitura plamky (opz.5568) vintage mink mortar with plamky finish</p>	 <p>rovere grigio (opz.3264) grey oak</p>	 <p>rovere naturale vintage (opz.5310L) vintage natural oak</p>
 <p>noce canaletto (opz.5501) canaletto walnut</p>	 <p>noce sinfonia (opz.4625) symphony walnut</p>		

Box alimentazione Power supply box

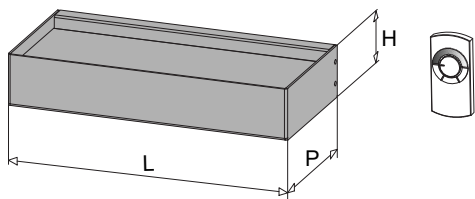

N.B.: disponibile solo per il mercato Europeo
Note: only available for the European market

BOX ALIMENTAZIONE MENSOLA SHELF POWER SUPPLY BOX

FINITURA Finish	A/V*	CODICE Code
■ Nero black	A	086BHM01AL11
■ Titanio titanium	A	086BHM01AL12

COMPONENTI INTERNI CABLATI:

3T494502: Driver 24V 100W con cavo e spina 110V
(Certificazione internazionale)

6SP704: Spina EU standard mt2 c/connettore JST femmina

6IN088: Selezionatore Dual Color 60W carico massimo

185057: Radiocomando Dimmer 12/24V CPL

WIRED INTERNAL COMPONENTS:

3T494502: Driver 24V 100W with cable and 110V plug
(International Certification)

6SP704: EU standard mt2 plug w/female JST connector

6IN088: Dual Color Selector 60W maximum load

185057: Dimmer remote control 12/24V CPL

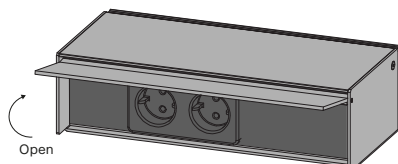
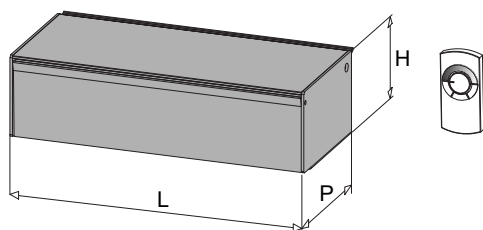

N.B.: disponibile solo per il mercato Europeo
Note: only available for the European market

BOX ALIMENTAZIONE MENSOLA CON PRESE ELETTRICHE POWER SUPPLY BOX SHELF WITH ELECTRICAL SOCKETS

FINITURA Finish	A/V*	CODICE Code
■ Nero black	A	086BHM02AL11
■ Titanio titanium	A	086BHM02AL12

COMPONENTI INTERNI CABLATI:

3T494502: Driver 24V 100W con cavo e spina 110V JST
(Certificazione internazionale)

6SP704: Spina EU standard mt2 c/connettore JST femmina

6IN088: Selezionatore Dual Color 60W carico massimo

185057: Radiocomando Dimmer 12/24V CPL

159102000110: 2 Prese Schuko

659006030500: Cavo 3 MT c/connettore GST18

WIRED INTERNAL COMPONENTS:

3T494502: Driver 24V 100W with cable and 110V plug
(International Certification)

6SP704: EU standard mt2 plug w/female JST connector

6IN088: Dual Color Selector 60W maximum load

185057: Dimmer remote control 12/24V CPL

159102000110: 2 Schuko sockets

659006030500: 3 MT cable with GST18 connector

NB: I Box vanno inseriti nella parte piu' estrema dx o sx della barra
Note: The Boxes must be inserted in the most extreme right or left part of the bar

ACCESSORI ELETTRICI (N.B.: da usare solo con punto luce comado a parete) ELECTRICAL ACCESSORIES (Note: to be used only with wall-mounted light point)

24V - 100W - CE - SELV - C - US

V IN	Hz	V OUT	W	L x P x H (mm)	EU PLUG	US PLUG
110V	50...60Hz	24V	100W	184 x 61 x 32	3T494504	24V - Cavo per connessione singola / Single connecting cable

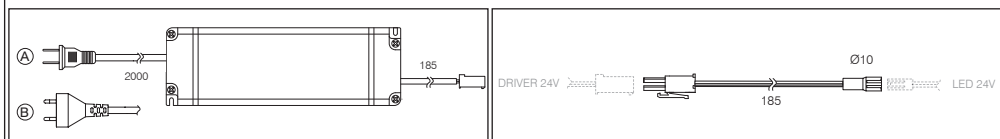
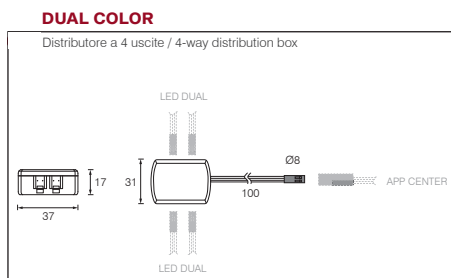

DESCRIZIONE Description

Distributore 4 uscite distributor 4 outputs
Alimentatore US/Canada power supply
Alimentatore EU power supply
Cavo alimentazione power cable

CODICE Code

086BHM66
086BHM61
086BHM60
086BHM65

*A/V: A=ANODIZZATO V=VERNICIATO
ANODIZED PAINTED

Box alimentazione Power supply box

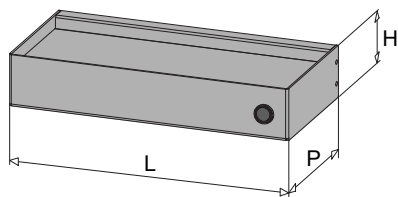

N.B.: disponibile solo per il mercato Europeo
Note: only available for the European market

BOX ALIMENTAZIONE MENSOLA C/PULSANTE POWER SUPPLY BOX SHELF WITH BUTTON

FINITURA Finish	A/V*	CODICE Code
■ Nero black	A	086BHM03AL11
■ Titanio titanium	A	086BHM03AL12

COMPONENTI INTERNI CABLATI:

3T492803: Driver 24V 60W con cavo e spina 110V JST
(Certificazione CE)

6SP704: Spina EU standard mt2 c/connettore JST femmina

6IN011: Interruttore cablato

6IN01101: Tasto per interruttore

WIRED INTERNAL COMPONENTS:

3T492803: Driver 24V 60W with cable and 110V JST plug (CE Certification)

6SP704: EU standard mt2 plug w/female JST connector

6IN011: Wired switch

6IN01101: Switch button

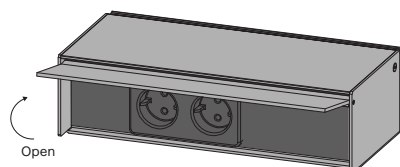
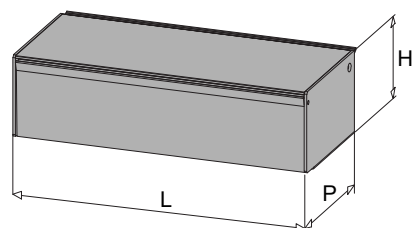

N.B.: disponibile solo per il mercato Europeo
Note: only available for the European market

BOX MENSOLA SOLO CON PRESE ELETTRICHE BOX SHELF ONLY WITH ELECTRICAL SOCKETS

FINITURA Finish	A/V*	CODICE Code
■ Nero black	A	086BHM07AL11
■ Titanio titanium	A	086BHM07AL12

COMPONENTI INTERNI CABLATI:

159102000110: D2 Prese Schuko

659006030500: Cavo 3 MT c/connettore GST18

WIRED INTERNAL COMPONENTS:

159102000110: D2 Schuko sockets

659006030500: 3 MT cable with GST18 connector

*NB: I Box vanno inseriti nella parte piu' estrema dx o sx della barra
Note: The Boxes must be inserted in the most extreme right or left part of the bar*

Accessori alluminio Aluminium accessories

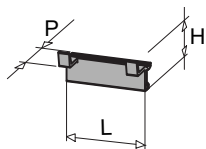

GANCIO PORTAOGGETTI DOPPIO L.80 P.38,5 H.37 DOUBLE STORAGE HOOK L.80 D.38,5 H.37

FINITURA Finish	A/V*	CODICE Code
■ Nero black	A	086BHM10AL11
■ Titanio titanium	A	086BHM10AL12

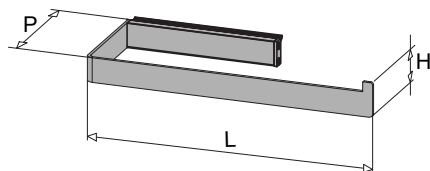

PORTAROTOLO L.294 P.115 H.25 ROLL HOLDER L.294 D.115 H.25

FINITURA Finish	A/V*	CODICE Code
■ Nero black	A	086BHM11AL11
■ Titanio titanium	A	086BHM11AL12

MENSOLA PIANA ALLUMINIO L.300 P.120 H.3 FLAT ALUMINUM SHELF L.300 D.120 H.3

FINITURA Finish	A/V*	CODICE Code
■ Nero black	A	086BHM20AL11
■ Titanio titanium	A	086BHM20AL12

MENSOLA PIANA ALLUMINIO L.450 P.120 H.3 FLAT ALUMINUM SHELF L.450 D.120 H.3

FINITURA Finish	A/V*	CODICE Code
■ Nero black	A	086BHM21AL11
■ Titanio titanium	A	086BHM21AL12

MENSOLA PIANA ALLUMINIO L.600 P.120 H.3 FLAT ALUMINUM SHELF L.600 D.120 H.3

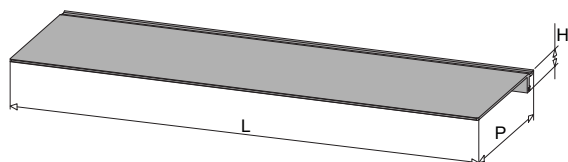

FINITURA Finish	A/V*	CODICE Code
■ Nero black	A	086BHM22AL11
■ Titanio titanium	A	086BHM22AL12

MENSOLA PIANA ALLUMINIO L.900 P.120 H.3 FLAT ALUMINUM SHELF L.900 D.120 H.3

FINITURA Finish	A/V*	CODICE Code
■ Nero black	A	086BHM23AL11
■ Titanio titanium	A	086BHM23AL12

MENSOLA PIANA ALLUMINIO L.1200 P.120 H.3 FLAT ALUMINUM SHELF L.1200 D.120 H.3

FINITURA Finish	A/V*	CODICE Code
■ Nero black	A	086BHM24AL11
■ Titanio titanium	A	086BHM24AL12

MENSOLA PIANA ALLUMINIO L.1500 P.120 H.3 FLAT ALUMINUM SHELF L.1500 D.120 H.3

FINITURA Finish	A/V*	CODICE Code
■ Nero black	A	086BHM25AL11
■ Titanio titanium	A	086BHM25AL12

*A/V: A=ANODIZZATO V=VERNICIATO
ANODIZED PAINTED

Accessori alluminio Aluminium accessories

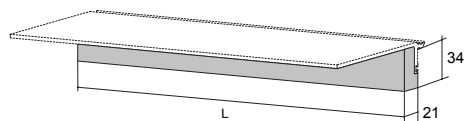

*N.B.: prima del montaggio forare il pannello per passaggio cavo.
Non inseribile con pannello in composito*
Note: before assembly, drill the panel for cable passage
Cannot be inserted with composite panel

PROFILO LUCE PER MENSOLA PROFILE LIGHT FOR SHELF

FINITURA Finish	Lunghezza Length	A/V*	CODICE Code
■ Nero black	L 30	A	086BHM70AL11
■ Titanio titanium	L 30	A	086BHM70AL12
■ Nero black	L 45	A	086BHM71AL11
■ Titanio titanium	L 45	A	086BHM71AL12
■ Nero black	L 60	A	086BHM72AL11
■ Titanio titanium	L 60	A	086BHM72AL12
■ Nero black	L 90	A	086BHM73AL11
■ Titanio titanium	L 90	A	086BHM73AL12
■ Nero black	L 120	A	086BHM74AL11
■ Titanio titanium	L 120	A	086BHM74AL12
■ Nero black	L 150	A	086BHM75AL11
■ Titanio titanium	L 150	A	086BHM75AL12

Accessori alluminio e legno Aluminium and wood accessories

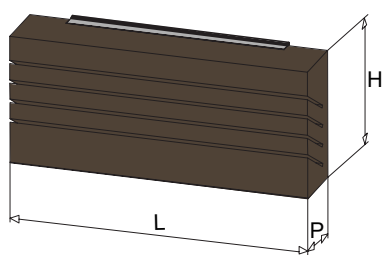

PORTACOLTELLI LEGNO SCURO + aggancio in finitura anodica L.300 P.60 H.130 KNIFE HOLDER IN DARK WOOD + anodic finish hook L.300 D.60 H.130

FINITURA Finish	A/V*	CODICE Code
■ ■ L. Scuro - Nero dark wood - black	A	086BHM12AL11
■ ■ L. Scuro - Titanio dark wood - titanium	A	086BHM12AL12

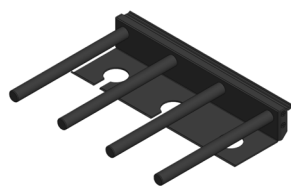

PORTABOTTIGLIE+CALICI L.267 P.193 H.43 BOTTLE+GLASS RACK L.267 D.193 H.43

FINITURA Finish	A/V*	CODICE Code
■ Nero black	A	086BHM14AL11
■ Titanio titanium	A	086BHM14AL12

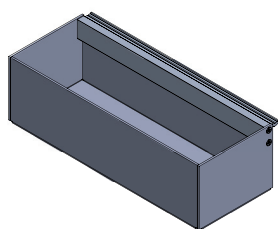

VASCHETTA PORTA PIANTINE L.285 P.110 H.85 SEEDLING TRAY L.285 D.110 H.85

FINITURA Finish	A/V*	CODICE Code
■ Nero black	A	086BHM47AL11
■ Titanio titanium	A	086BHM47AL12

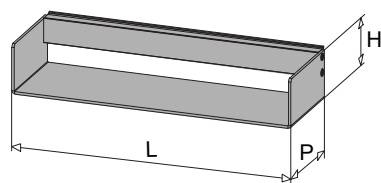

MENSOLA PORTAOGGETTI L.300 P.90 H.50 GLOVE SHELF L.300 D.90 H.50

FINITURA Finish	A/V*	CODICE Code
■ Nero black	A	086BHM40AL11
■ Titanio titanium	A	086BHM40AL12

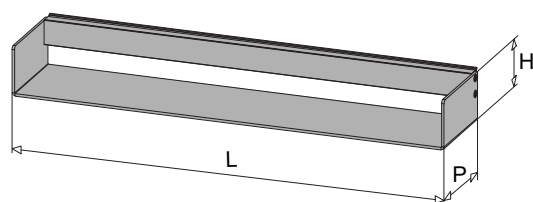

MENSOLA PORTAOGGETTI L.450 P.90 H.50 GLOVE SHELF L4500 D.90 H.50

FINITURA Finish	A/V*	CODICE Code
■ Nero black	A	086BHM41AL11
■ Titanio titanium	A	086BHM41AL12

*A/V: A=ANODIZZATO V=VERNICIATO
ANODIZED PAINTED

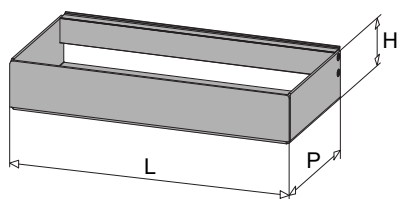

MENSOLA PORTAOGGETTI L.300 P.140 H.50
GLOVE SHELF L300 D.140 H.50

FINITURA Finish	A/V*	CODICE Code
■ Nero black	A	086BHM45AL11
■ Titanio titanium	A	086BHM45AL12

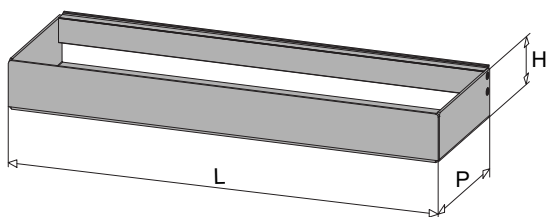

MENSOLA PORTAOGGETTI L.450 P.140 H.50
GLOVE SHELF L450 D.140 H.50

FINITURA Finish	A/V*	CODICE Code
■ Nero black	A	086BHM46AL11
■ Titanio titanium	A	086BHM46AL12

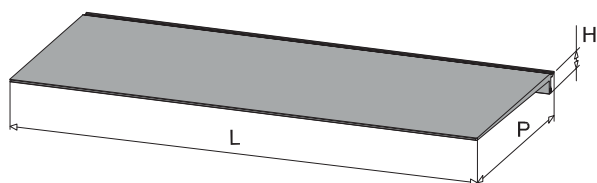

MENSOLA PIANA ALLUMINIO L.600 P.250 H.3
FLAT ALUMINUM SHELF L.600 D.250 H.3

FINITURA Finish	A/V*	CODICE Code
■ Nero black	A	086BHM32AL11
■ Titanio titanium	A	086BHM32AL12

SOLO PER COMPOSIZIONI LIVING
ONLY FOR LIVING COMPOSITIONS

NB: Nell'inserimento della mensola P 250, assicurarsi che il fissaggio dei pannelli a muro sia adeguato.

Note: When inserting the W 250 shelf, make sure the fixing of the panels to the wall is adequate.

MENSOLA PIANA ALLUMINIO L.900 P.250 H.3
FLAT ALUMINUM SHELF L.900 D.250 H.3

FINITURA Finish	A/V*	CODICE Code
■ Nero black	A	086BHM33AL11
■ Titanio titanium	A	086BHM33AL12

MENSOLA PIANA ALLUMINIO L.1200 P.250 H.3
FLAT ALUMINUM SHELF L.1200 D.250 H.3

FINITURA Finish	A/V*	CODICE Code
■ Nero black	A	086BHM34AL11
■ Titanio titanium	A	086BHM34AL12

MENSOLA PIANA ALLUMINIO L.1500 P.250 H.3
FLAT ALUMINUM SHELF L.1500 D.250 H.3

FINITURA Finish	A/V*	CODICE Code
■ Nero black	A	086BHM35AL11
■ Titanio titanium	A	086BHM35AL12

*A/V: A=ANODIZZATO V=VERNICIATO
ANODIZED PAINTED

PANNELLO SCHIENALE PER FUOCHI ALLUMINIO L.600 P.12 H.310
BACK PANEL FOR ALUMINUM FIREPLACE L.600 D.12 H.310

FINITURA Finish	A/V*	CODICE Code
■ Nero black	A	086BHM16AL11
■ Titanio titanium	A	086BHM16AL12

PANNELLO SCHIENALE PER FUOCHI ALLUMINIO L.600 P.12 H.340
BACK PANEL FOR ALUMINUM FIREPLACE L.600 D.12 H.340

FINITURA Finish	A/V*	CODICE Code
■ Nero black	A	086BHM50AL11
■ Titanio titanium	A	086BHM50AL12

PANNELLO SCHIENALE PER FUOCHI ALLUMINIO L.750 P.12 H.310
BACK PANEL FOR ALUMINUM FIREPLACE L.750 D.12 H.310

FINITURA Finish	A/V*	CODICE Code
■ Nero black	A	086BHM17AL11
■ Titanio titanium	A	086BHM17AL12

PANNELLO SCHIENALE PER FUOCHI ALLUMINIO L.750 P.12 H.340
BACK PANEL FOR ALUMINUM FIREPLACE L.750 D.12 H.340

FINITURA Finish	A/V*	CODICE Code
■ Nero black	A	086BHM51AL11
■ Titanio titanium	A	086BHM51AL12

PANNELLO SCHIENALE PER FUOCHI ALLUMINIO L.900 P.12 H.310
BACK PANEL FOR ALUMINUM FIREPLACE L.900 D.12 H.310

FINITURA Finish	A/V*	CODICE Code
■ Nero black	A	086BHM19AL11
■ Titanio titanium	A	086BHM19AL12

PANNELLO SCHIENALE PER FUOCHI ALLUMINIO L.900 P.12 H.340
BACK PANEL FOR ALUMINUM FIREPLACE L.900 D.12 H.340

FINITURA Finish	A/V*	CODICE Code
■ Nero black	A	086BHM53AL11
■ Titanio titanium	A	086BHM53AL12

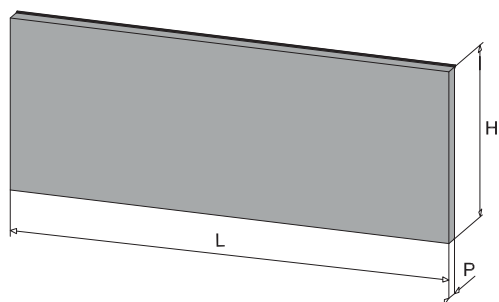

GANCIO DOPPIO
Double Hook

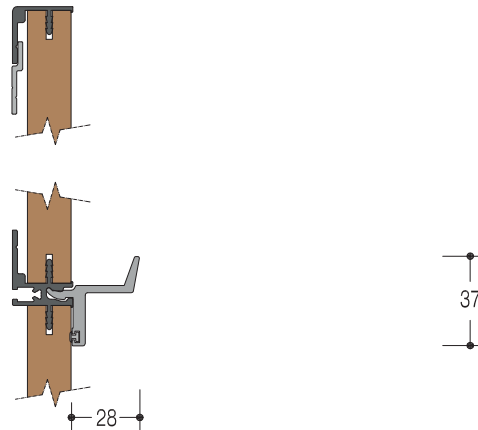

PORTAROTOLO
Roll Holder

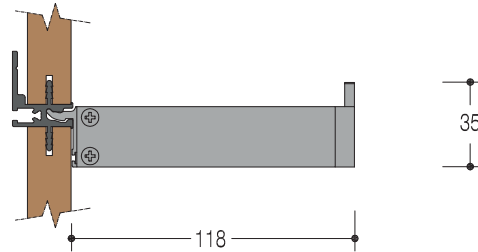

PORTAOGGETTI
Glove Holder

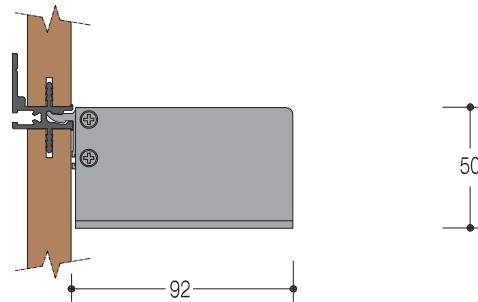

PORTACOLTELLI
Knife Holder

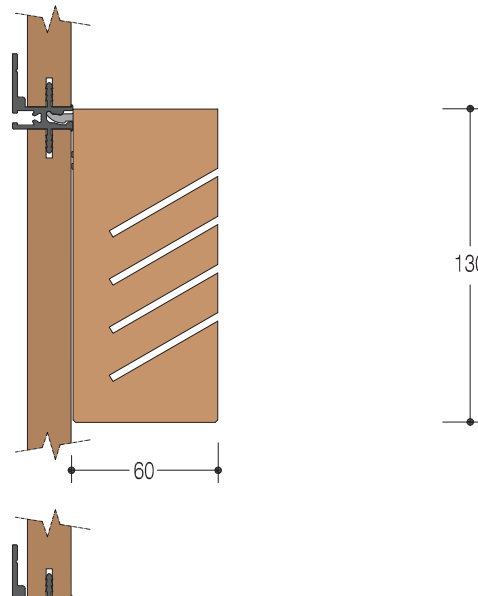

MENSOLA PROF. 130
Shelf Depth.130

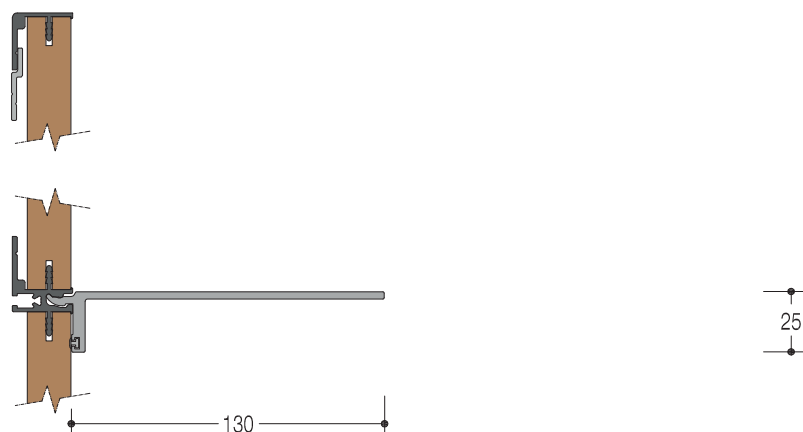

MENSOLA PROF. 250
Shelf Depth.250

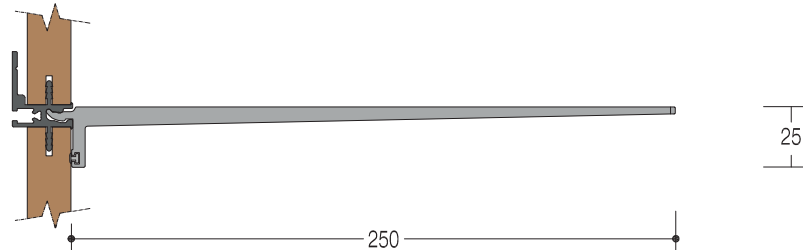

**PROFILO LED PER MENSOLA
PROF. 130/250**
Led Profile for Shelf Depth.130/250

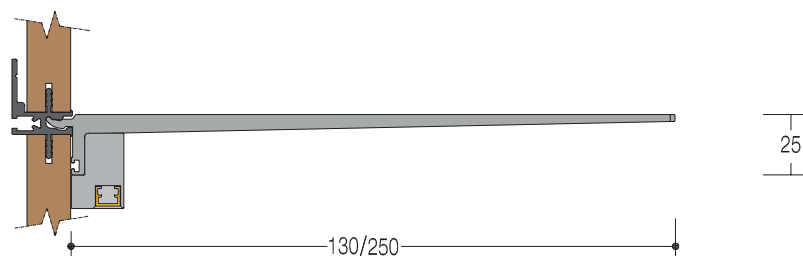

BOX ILLUMINAZIONE
Lighting Box

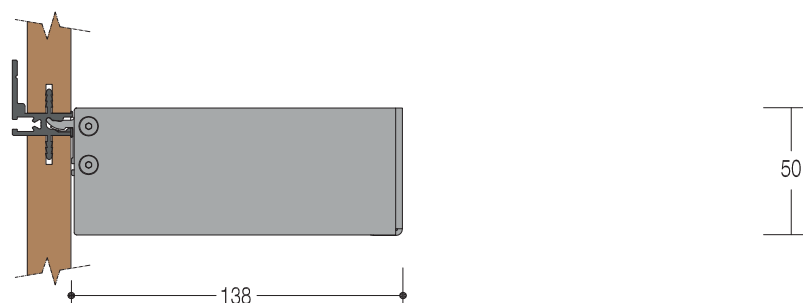

BOX PRESE
Socket Box

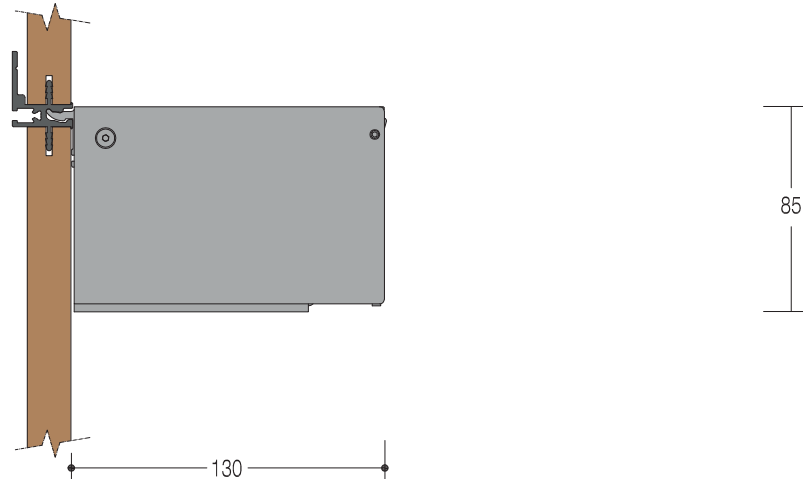

CATEGORIA PARETE WALL CATEGORY

Rappresentazione di soluzioni per rivestimento parete, in funzione degli allineamenti dei pensili della cucina di riferimento. Le quote sono puramente indicative e vanno adattate alla reale condizione reali di installazione (irregolarità della pavimentazione/regolazione dei piedi).

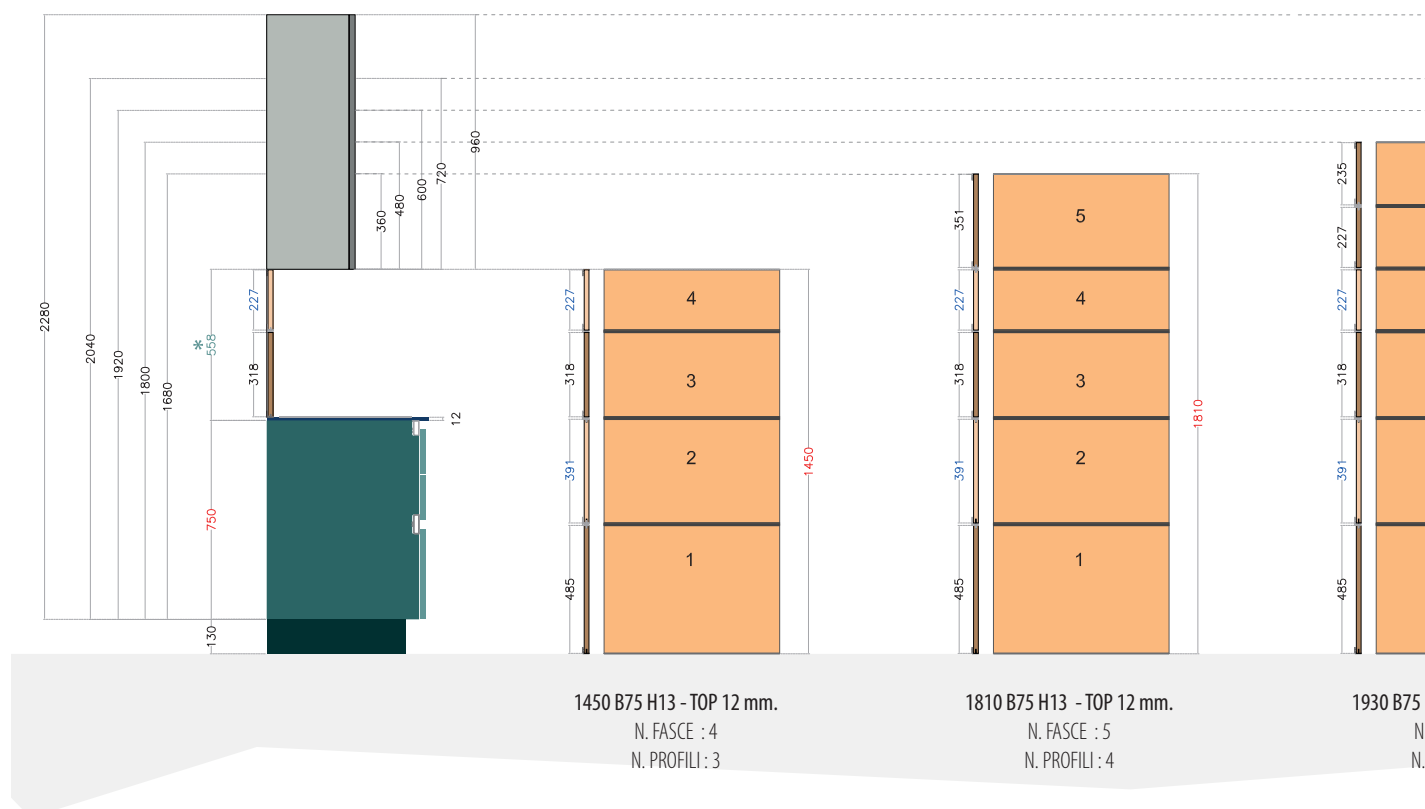

QUOTE JOLLY AD ALTEZZA VARIABILE

Le altezze indicate nelle fasce n. 2 e n.4 possono variare la loro altezza in relazione allo spessore del piano. Questo per mantenere sempre gli allineamenti per ogni tipologia di top.

Nel disegno presente nella parte superiore vengono riportati gli allineamenti considerando il top spessore 12 mm. Per le altre tipologie occorre considerare le seguenti differenze:

TOP H 20 = H + 8 mm per FASCIA 2
H - 8 mm per FASCIA 4

TOP H 22 = H + 10 mm per FASCIA 2
H - 10 mm per FASCIA 4

TOP H 30 = H + 18 mm per FASCIA 2
H - 18 mm per FASCIA 4

TOP H 40 = H + 28 mm per FASCIA 2
H - 28 mm per FASCIA 4

BASE H 75 bridge ZOCCOLO 13
BASE H 75 bridge PLINTH 13

Representation of solutions for wall covering, depending on the alignments of the reference kitchen wall units. The dimensions are purely indicative and should be adapted to the actual condition of installation (unevenness of flooring/footing adjustment).

- **QUOTE DI RIFERIMENTO**
REFERENCE QUOTE
- **QUOTE JOLLY (H VARIABILE)**
JOLLY QUOTE (H VARIABLE)
- **QUOTE FISSE**
FIXED DIMENSION
- **QUOTE H TRA BASE E PENSILE**
DIMENSIONS BETWEEN BASE AND CABINET

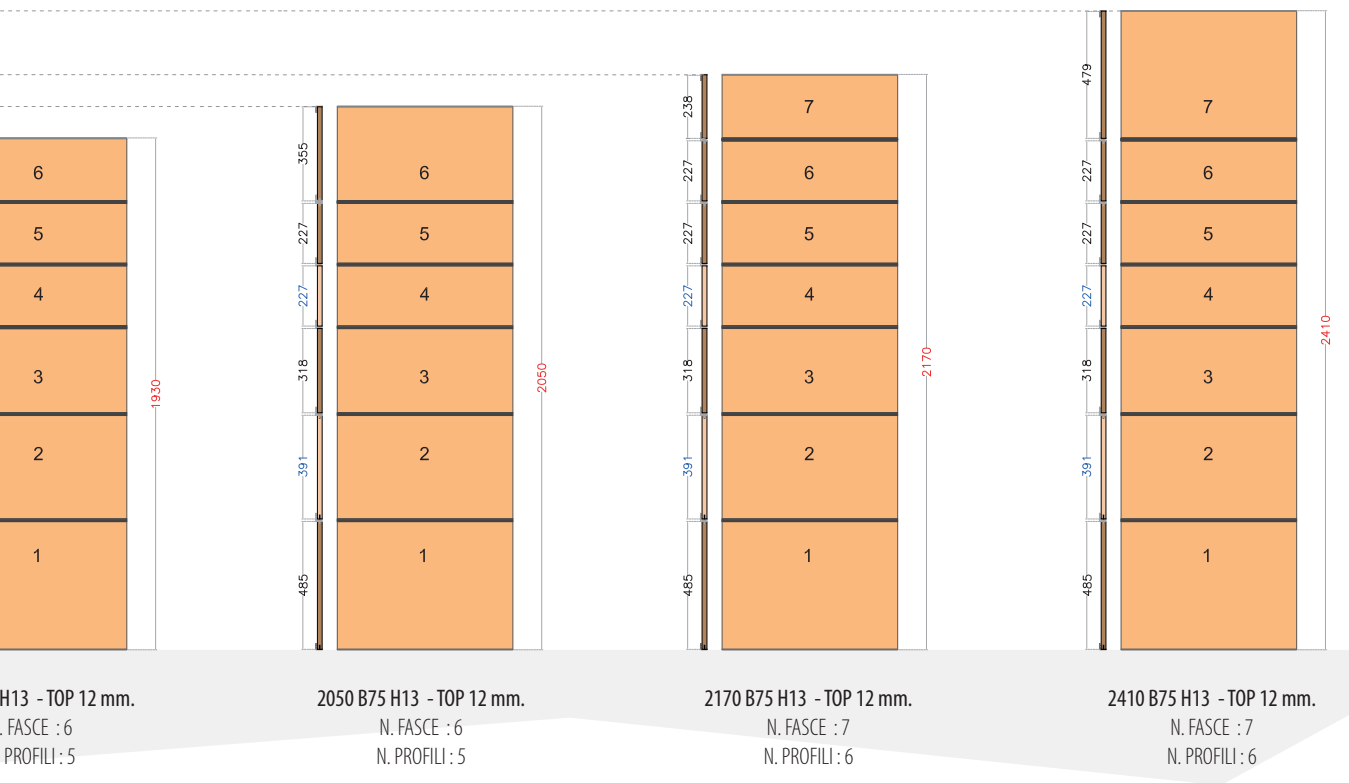

DIMENSIONS WITH VARIABLE HEIGHT

The heights indicated in the bands n. 2 and n.4 can change their height in relation to the top thickness. This solution it was designed for maintaining alignments for each type of top.

The drawings in the upper, consider the top with thick 12 mm. For the other types, must be considered the difference below:

- TOP H 20** = H + 8 mm for band 2
H - 8 mm for band 4
- TOP H 22** = H + 10 mm for band 2
H - 10 mm for band 4
- TOP H 30** = H + 18 mm for band 2
H - 18 mm for band 4
- TOP H 40** = H + 28 mm for band 2
H - 28 mm for band 4

CATEGORIA PARETE WALL CATEGORY

Rappresentazione di soluzioni per rivestimento parete, in funzione degli allineamenti dei pensili della cucina di riferimento. Le quote sono puramente indicative e vanno adattate alla reale condizione reali di installazione (irregolarità della pavimentazione/regolazione dei piedi).

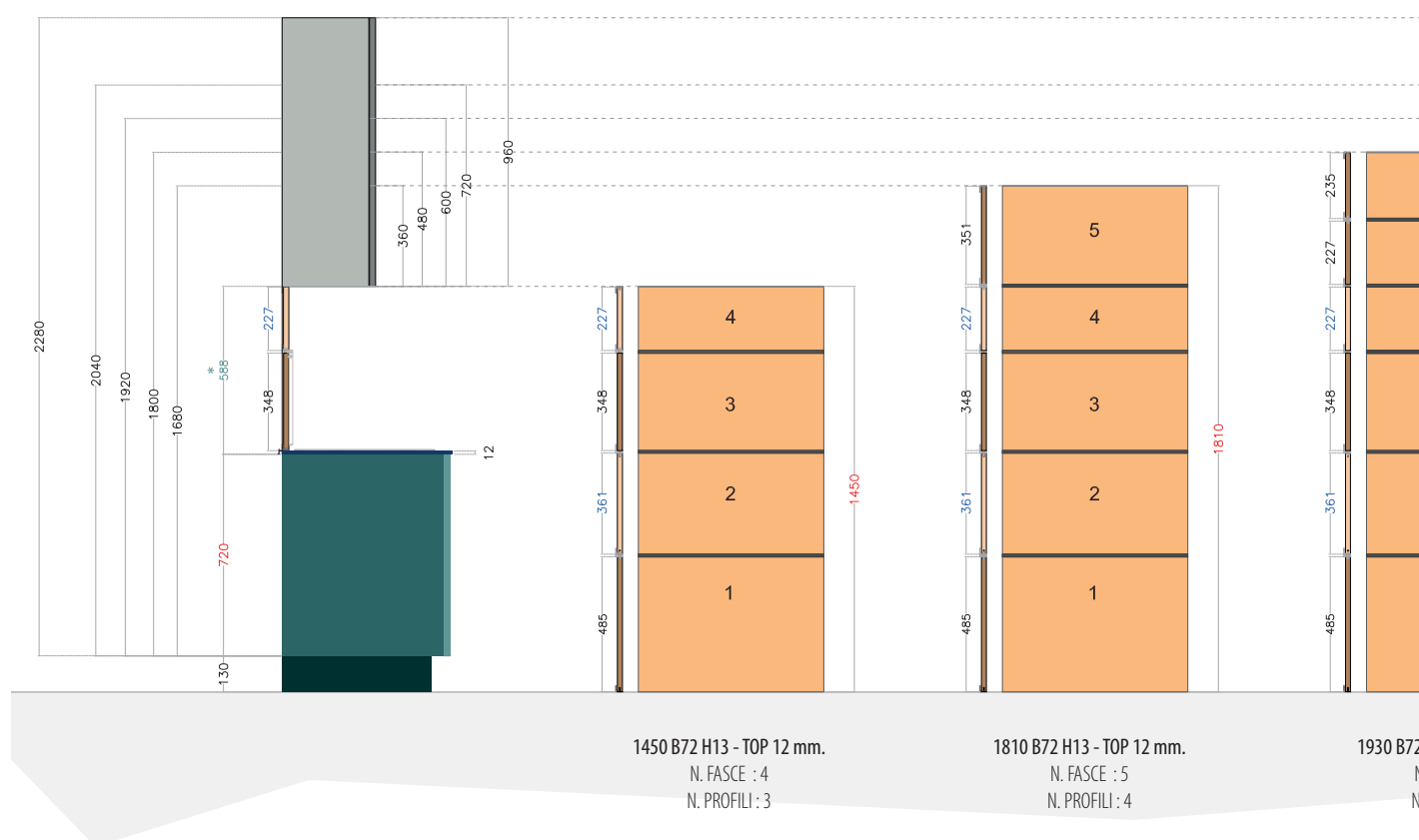

QUOTE JOLLY AD ALTEZZA VARIABILE

Le altezze indicate nelle fasce n. 2 e n.4 possono variare la loro altezza in relazione allo spessore del piano. Questo per mantenere sempre gli allineamenti per ogni tipologia di top.

Nel disegno presente nella parte superiore vengono riportati gli allineamenti considerando il top spessore 12 mm. Per le altre tipologie occorre considerare le seguenti differenze:

TOP H 20 = H + 8 mm per FASCIA 2
H - 8 mm per FASCIA 4

TOP H 22 = H + 10 mm per FASCIA 2
H - 10 mm per FASCIA 4

TOP H 30 = H + 18 mm per FASCIA 2
H - 18 mm per FASCIA 4

TOP H 40 = H + 28 mm per FASCIA 2
H - 28 mm per FASCIA 4

BASE H 72 neck ZOCCOLO 13
BASE H 72 neck PLINTH 13

Representation of solutions for wall covering, depending on the alignments of the reference kitchen wall units. The dimensions are purely indicative and should be adapted to the actual condition of installation (unevenness of flooring/footing adjustment).

- **QUOTE DI RIFERIMENTO**
REFERENCE QUOTE
- **QUOTE JOLLY (H VARIABILE)**
JOLLY QUOTE (H VARIABLE)
- **QUOTE FISSE**
FIXED DIMENSION
- **QUOTE H TRA BASE E PENSILE**
DIMENSIONS BETWEEN BASE AND CABINET

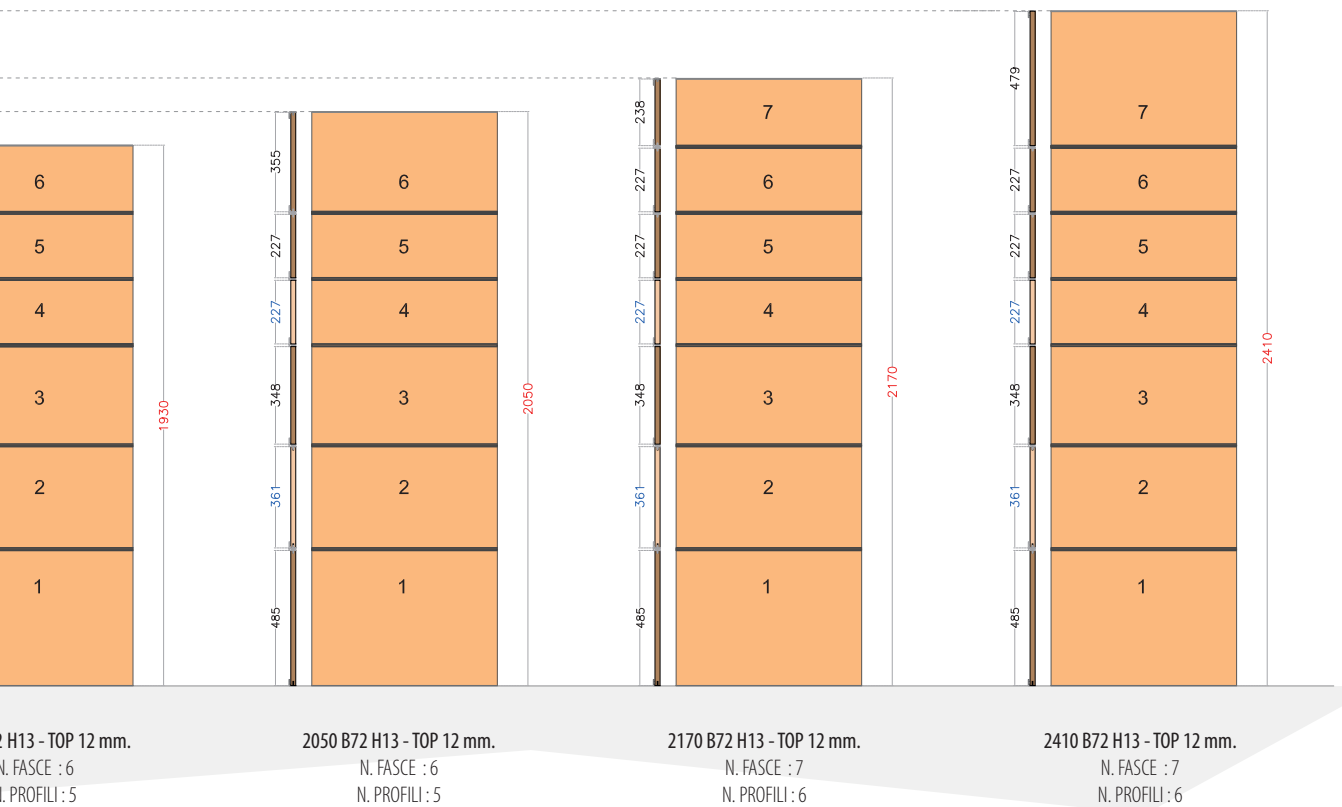

DIMENSIONS WITH VARIABLE HEIGHT

The heights indicated in the bands n. 2 and n.4 can change their height in relation to the top thickness. This solution it was designed for maintaining alignments for each type of top.

The drawings in the upper, consider the top with thick 12 mm. For the other types, must be considered the difference below:

- TOP H 20** = H + 8 mm for band 2
H - 8 mm for band 4
- TOP H 22** = H + 10 mm for band 2
H - 10 mm for band 4
- TOP H 30** = H + 18 mm for band 2
H - 18 mm for band 4
- TOP H 40** = H + 28 mm for band 2
H - 28 mm for band 4

BASE H 84 bridge ZOCCOLO 13
BASE H 84 bridge PLINTH 13

Representation of solutions for wall covering, depending on the alignments of the reference kitchen wall units. The dimensions are purely indicative and should be adapted to the actual condition of installation (unevenness of flooring/footing adjustment).

- **QUOTE DI RIFERIMENTO**
REFERENCE QUOTE
- **QUOTE JOLLY (H VARIABILE)**
JOLLY QUOTE (H VARIABLE)
- **QUOTE FISSE**
FIXED DIMENSION
- **QUOTE H TRA BASE E PENSILE**
DIMENSIONS BETWEEN BASE AND CABINET

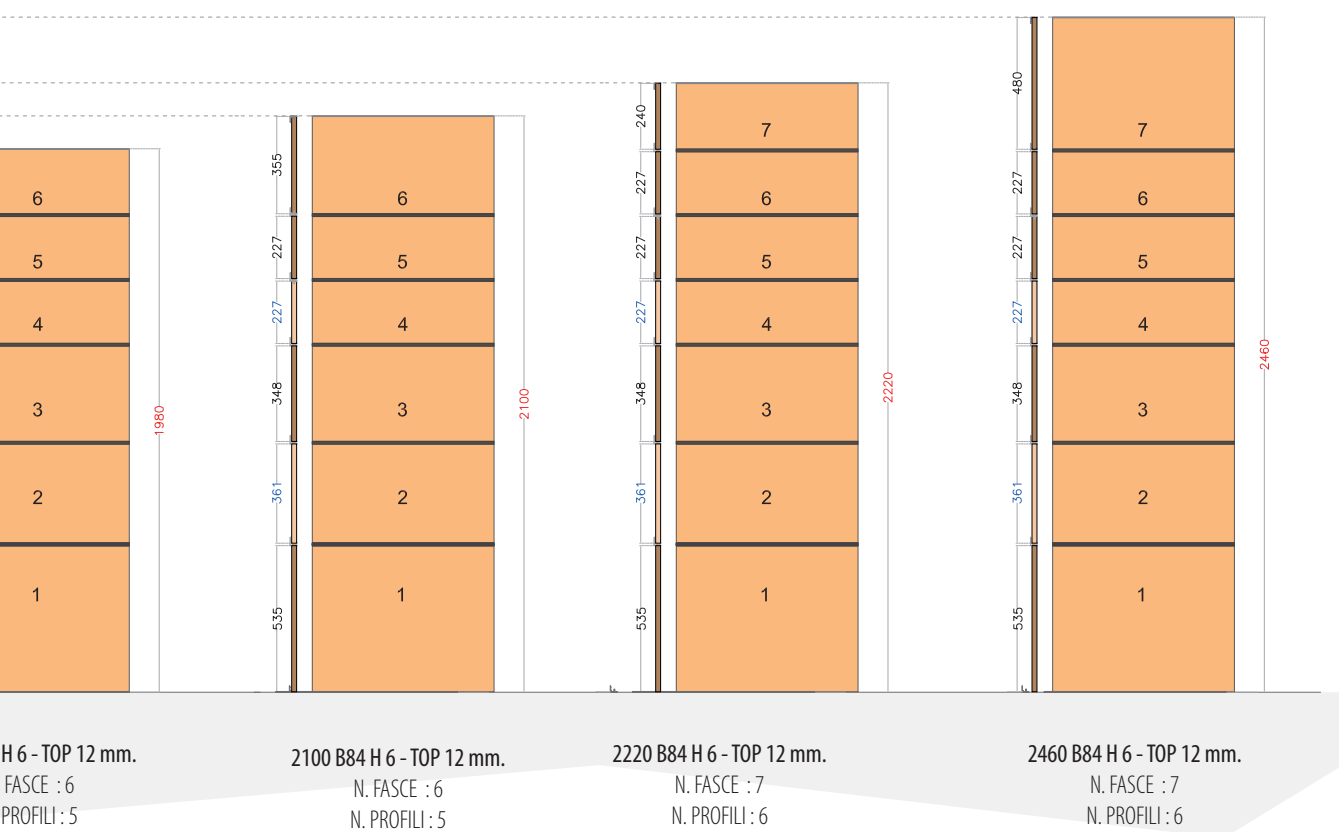

DIMENSIONS WITH VARIABLE HEIGHT

The heights indicated in the bands n. 2 and n.4 can change their height in relation to the top thickness. This solution it was designed for maintaining alignments for each type of top.

The drawings in the upper, consider the top with thick 12 mm. For the other types, must be considered the difference below:

- TOP H 20** = H + 8 mm for band 2
H - 8 mm for band 4
- TOP H 22** = H + 10 mm for band 2
H - 10 mm for band 4
- TOP H 30** = H + 18 mm for band 2
H - 18 mm for band 4
- TOP H 40** = H + 28 mm for band 2
H - 28 mm for band 4

CATEGORIA PARETE WALL CATEGORY

Rappresentazione di soluzioni per rivestimento parete, in funzione degli allineamenti dei pensili della cucina di riferimento. Le quote sono puramente indicative e vanno adattate alla reale condizione reali di installazione (irregolarità della pavimentazione/regolazione dei piedi).

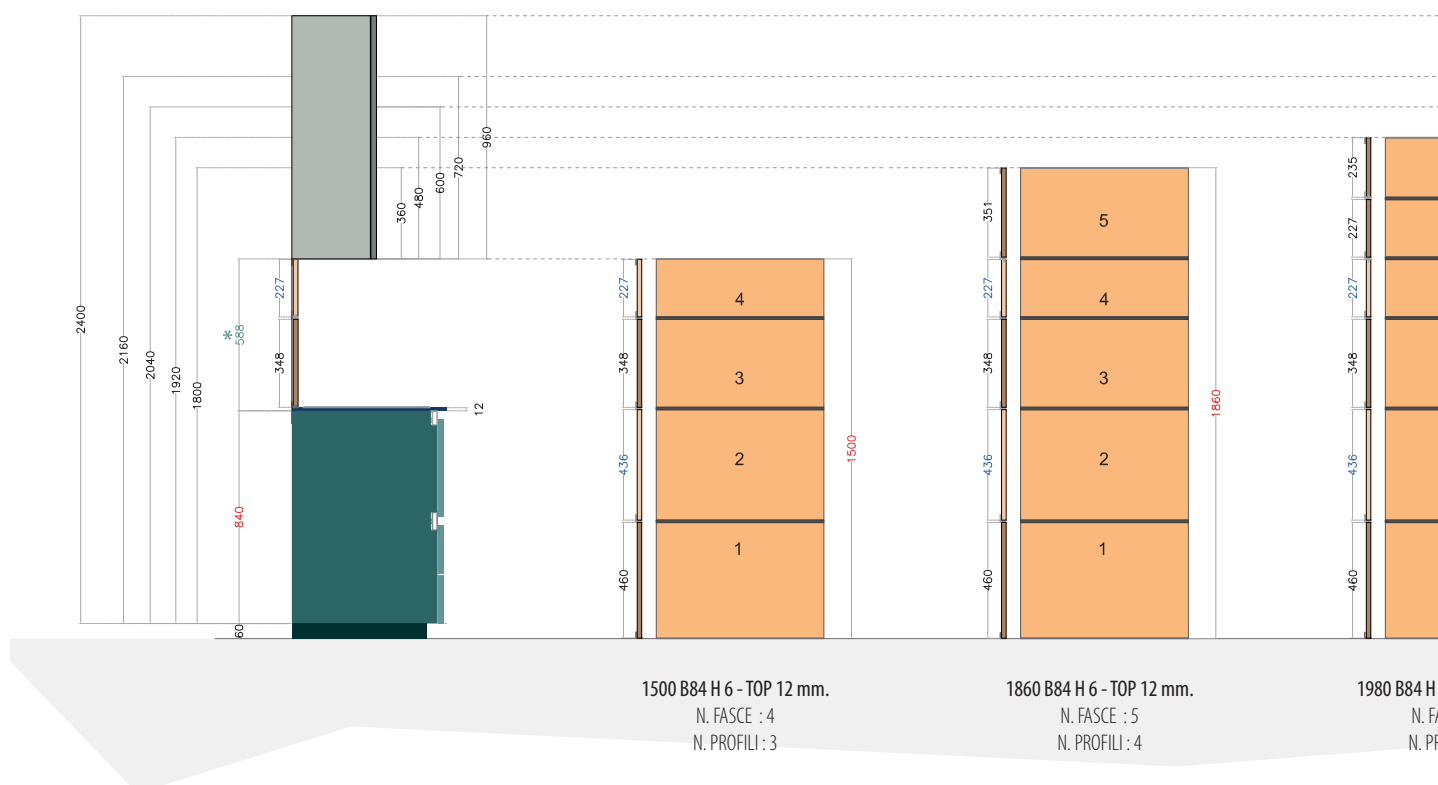

QUOTE JOLLY AD ALTEZZA VARIABILE

Le altezze indicate nelle fasce n. 2 e n.4 possono variare la loro altezza in relazione allo spessore del piano. Questo per mantenere sempre gli allineamenti per ogni tipologia di top.

Nel disegno presente nella parte superiore vengono riportati gli allineamenti considerando il top spessore 12 mm. Per le altre tipologie occorre considerare le seguenti differenze:

TOP H 20 = H + 8 mm per FASCIA 2
H - 8 mm per FASCIA 4

TOP H 22 = H + 10 mm per FASCIA 2
H - 10 mm per FASCIA 4

TOP H 30 = H + 18 mm per FASCIA 2
H - 18 mm per FASCIA 4

TOP H 40 = H + 28 mm per FASCIA 2
H - 28 mm per FASCIA 4

BASE H 84 neck ZOCCOLO 13
BASE H 84 neck PLINTH 13

Representation of solutions for wall covering, depending on the alignments of the reference kitchen wall units. The dimensions are purely indicative and should be adapted to the actual condition of installation (unevenness of flooring/footing adjustment).

- **QUOTE DI RIFERIMENTO**
REFERENCE QUOTE
- **QUOTE JOLLY (H VARIABILE)**
JOLLY QUOTE (H VARIABLE)
- **QUOTE FISSE**
FIXED DIMENSION
- **QUOTE H TRA BASE E PENSILE**
DIMENSIONS BETWEEN BASE AND CABINET

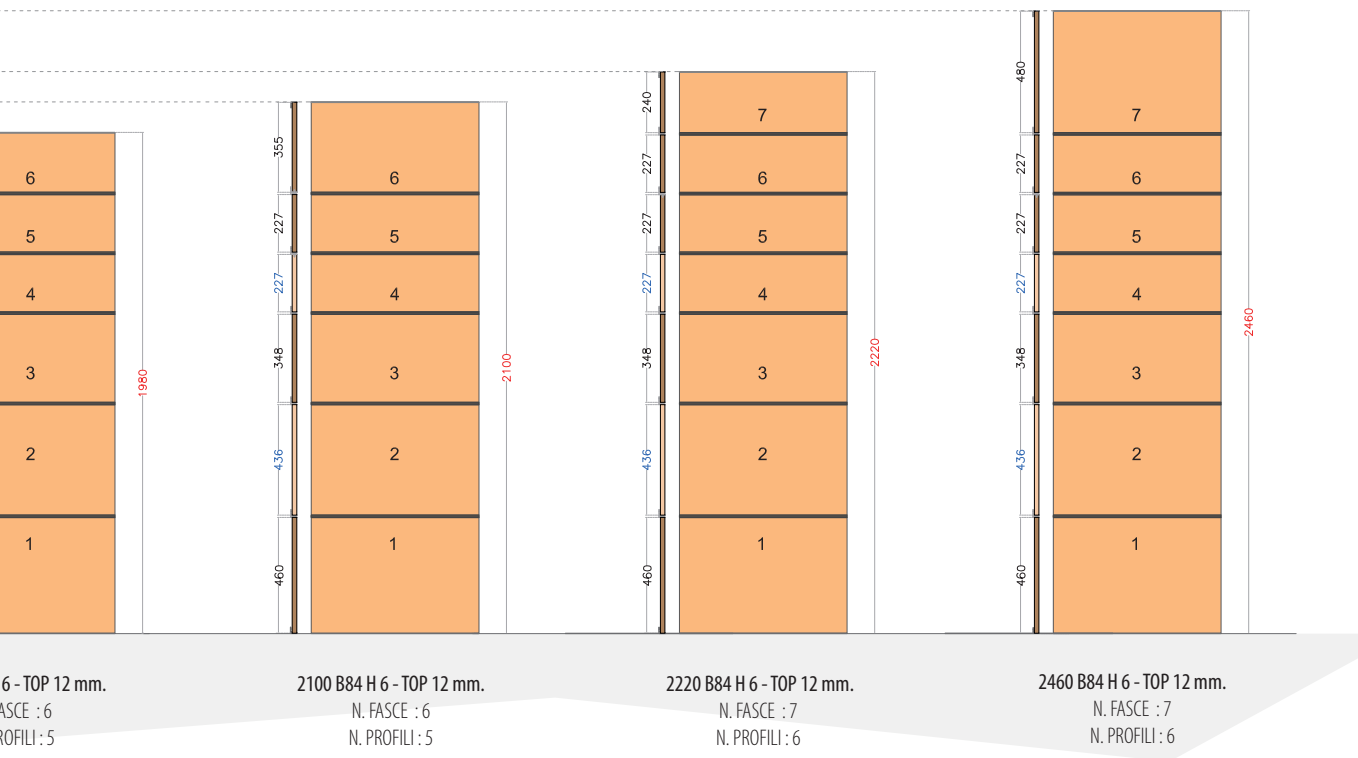

DIMENSIONS WITH VARIABLE HEIGHT

The heights indicated in the bands n. 2 and n.4 can change their height in relation to the top thickness. This solution it was designed for maintaining alignments for each type of top.

The drawings in the upper, consider the top with thick 12 mm. For the other types, must be considered the difference below:

- TOP H 20** = H + 8 mm for band 2
H - 8 mm for band 4
- TOP H 22** = H + 10 mm for band 2
H - 10 mm for band 4
- TOP H 30** = H + 18 mm for band 2
H - 18 mm for band 4
- TOP H 40** = H + 28 mm for band 2
H - 28 mm for band 4

LIVING LIVING AREA

La categoria living rappresenta la soluzione di massima personalizzazione. E' pensata per dare la possibilità di scegliere liberamente il numero di profili e di pannelli nella composizione.

The living category is the solution for the maximum customization. Its designed to give the possibility to choose the composition, freely, both the number of profiles and panels.

ESPLOSO COMPONENTI PER COMPOSIZIONE LIVING - BLOWN-UP COMPONENTS FOR LIVING COMPOSITION

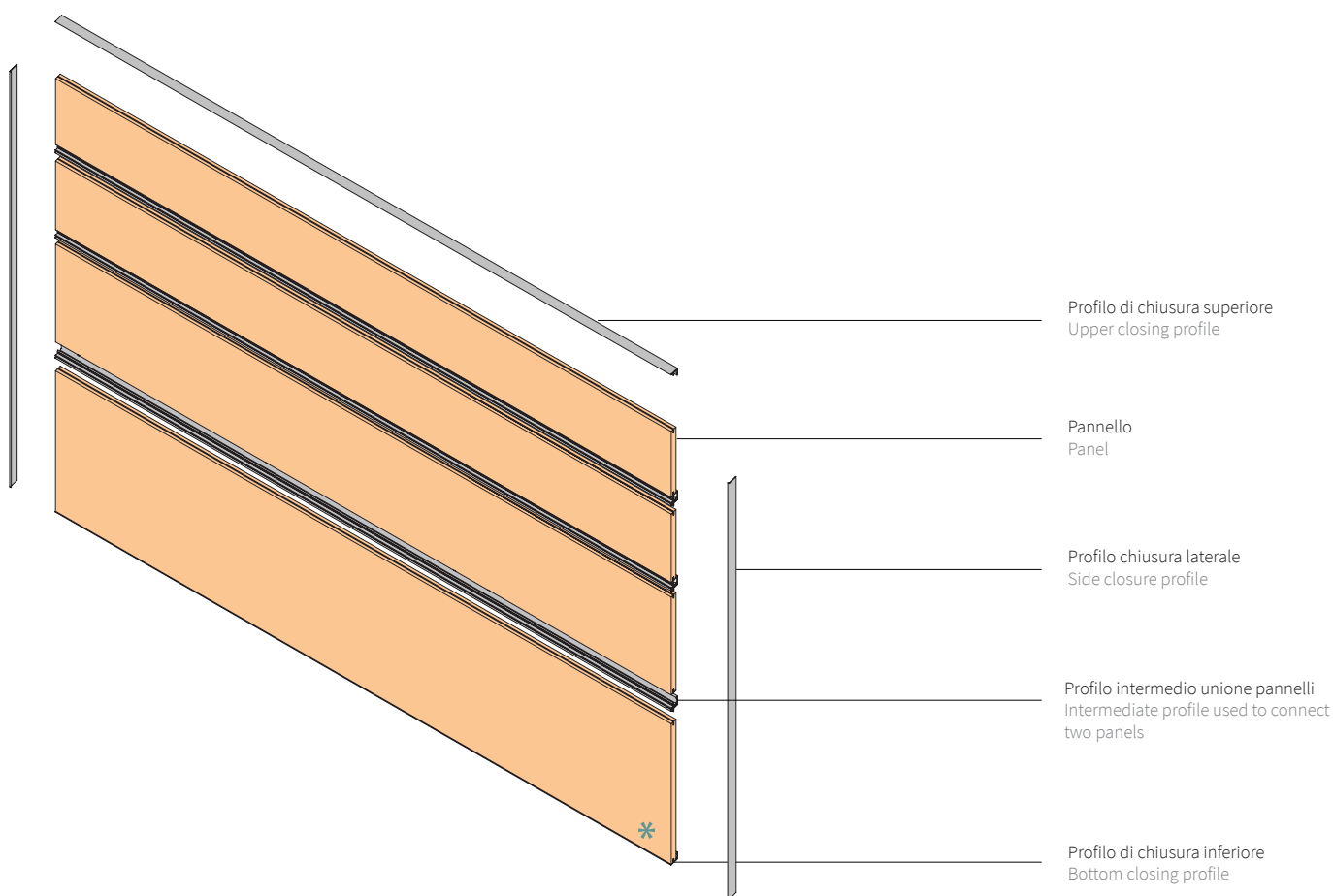

*
Opzione pannello inferiore in GRES, QUARZO o HPL solo per categoria CUCINA
Option bottom panel in STONEWARE ,QUARTZ or HPL is available only for KITCHEN category

FINITURE PANNELLI - PANEL FINISHES

Le finiture dei pannelli possono essere delle seguenti categorie:
MELAMINICO - LAMINATO - LACCATO UV - FENIX - WOOD - MATHERA - IMPIALLACCIATO

The panel finishes can be made in the categories below:
MELAMINE - LAMINATE - UV LACQUERED - FENIX - WOOD - MATHERA - VENEERED

Finiture Alluminio
Aluminum Finishes

Nero
Anodizzato
Black
anodized



Titanio
Anodizzato
Titanium
anodized



Finiture Legno
Wood Finishes

Legno
Scuro
Wood
dark

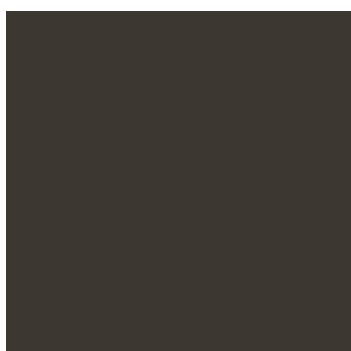

GRUPPOLUBE



PARETE BLUES

2023



PARETE "BLUES"

"BLUES" WALL



Noce canaletto con fondo nero
Noce canaletto with black bottom

BLUES è un pannello decorativo sp. 19 mm, composto da un fondo in MDF in pasta nera e listelli verticali squadrati L 15 mm in laminato finitura Noce canaletto.

Disponibile nella misura massima H 280 L 60 cm.

Possibilità di realizzare fuori misura in altezza e in larghezza con addebito dell'intero pannello

BLUES is a 19 mm thick decorative panel consisting of a black paste MDF base and 15 mm W squared vertical slats in Canaletto Walnut finish laminate.

Available in the maximum size H 280 W 60 cm.

Possibility of oversizing in height and width with charge of the entire panel

Pannello H 280 L 60 sp. 1,9 cm
Panel H 280 W 60 th. 1,9 cm

cod.086PBB01

Maggiorazione taglio/foro
Surcharge cut out/hole

cod.T9LSPB

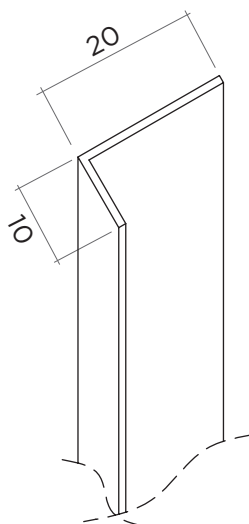
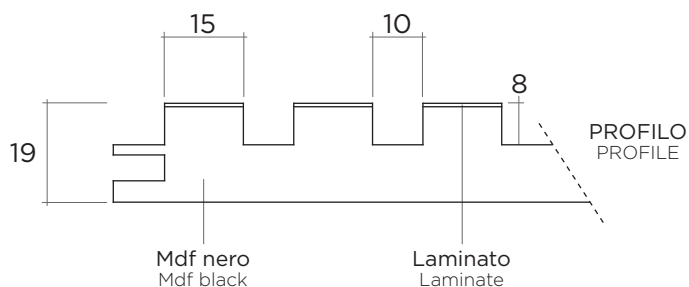

ACCESSORI ACCESSORIES

Profilo angolare di chiusura

Misure: 20x10x2800 mm

Obbligatorio nella parte inferiore del pannello. Nelle parti laterali inserire solo se il bordo del pannello è a vista.

Closing angle profile

Dimensions: 20x10x2800 mm

Mandatory in the lower part of the panel.

In the side parts, only insert if the edge of the panel is visible.

Profilo angolare cod.086PBB10
Corner profile