

Brera

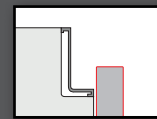

Neck

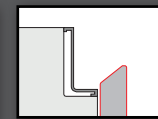

Easy



Bridge



ANTA:
DOOR:

SP: TH: **22** MM

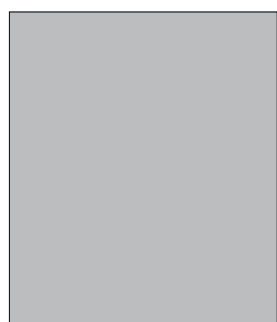

LISCIA
SMOOTH

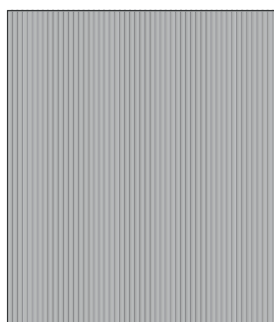

RAIN

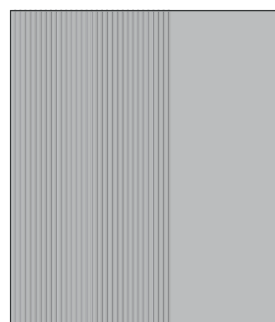

RAIN MIX

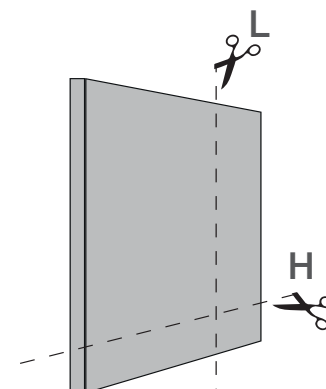

ANTA SP.22 MM
ABBINABILE CON:
TH. 22 MM DOOR
MATCHABLE WITH:

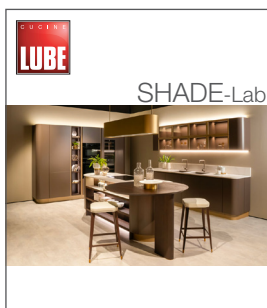

SHADE-Lab

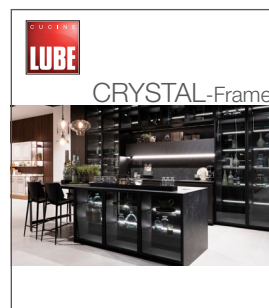

CRYSTAL-Frame

i Nella versione "RAIN" riduzione in larghezza possibile solo di 15mm su un lato o di 30mm su due lati.
In the "RAIN" version, is possible a reduction in width of only 15 mm on one side or 30 mm on both sides.

CONSULTA:
CONSULT:



MOBILI A GIORNO
SENZA ANTA
LISTINO 2024



MOBILI A GIORNO
CON ANTA
LISTINO 2024

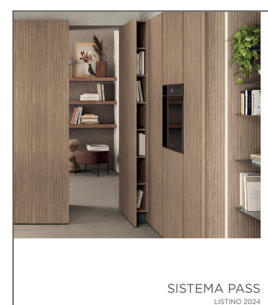

SISTEMA PASS
LISTINO 2024



PENISOLE
LISTINO 2024

ALTRO:
MORE:



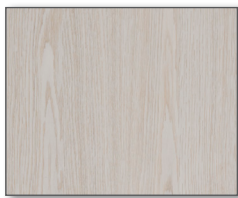

Rovere Moon
(opz.5450)



Rovere Moon Rain
(opz.5450R)



Rovere Moon Rain
Mix (opz.5450M)

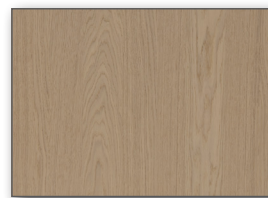

Rovere Nordico
(opz.5451)



Rovere Nordico Rain
(opz.5451R)

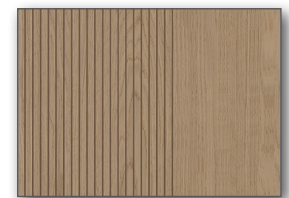

Rovere Nordico Rain
Mix (opz.5451M)



Rovere Curry
(opz.5452)



Rovere Curry Rain
(opz.5452R)



Rovere Curry Rain
Mix (opz.5452M)



Rovere Brandy
(opz.5455)



Rovere Brandy Rain
(opz.5455R)



Rovere Brandy Rain
Mix (opz.5455M)



Rovere Torba
(opz.5454)



Rovere Torba Rain
(opz.5454R)



Rovere Torba Rain
Mix (opz.5454M)

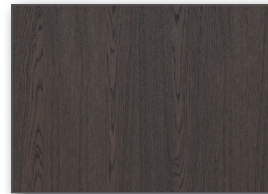

Rovere Tarmac
(opz.5453)



Rovere Tarmac Rain
(opz.5453R)



Rovere Tarmac Rain
Mix (opz.5453M)



Noce Canaletto Intenso
(opz.1332)



Noce Canaletto Natural
(opz.1333)

Impiallacciato Rovere Oak Veneered

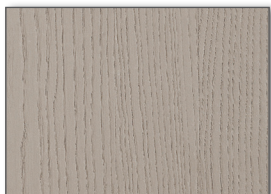

Arizona ash
(opz.2437)

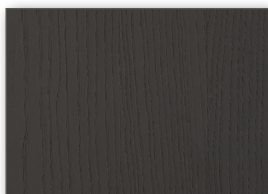

Aragona ash
(opz.2438)

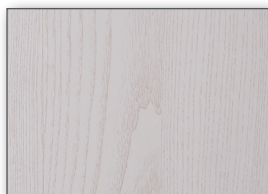

Rafia ash
(opz.2436)

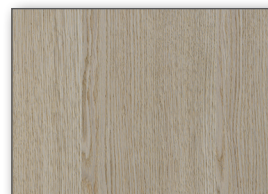

Namib oak
(opz.5447)

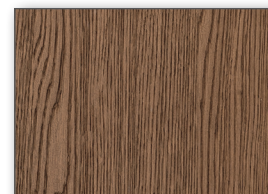

Moscato oak
(opz.5448)

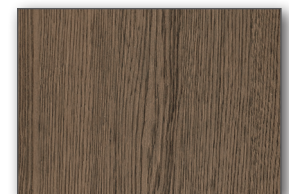

Fumè oak
(opz.5449)

Impiallacciato Frassino Ash Veneered

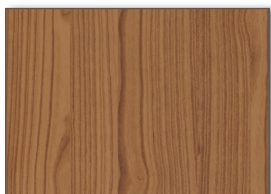

Paulownia Toffee
(opz.085)

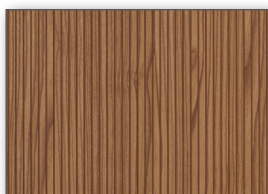

Paulownia Toffee Rain
(opz.085R)

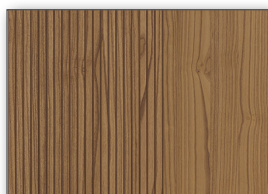

Paulownia Toffee Rain
Mix (opz.085M)

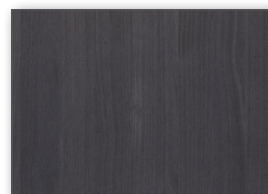

Paulownia Grigio Acai
(opz.086)



Paulownia Grigio Acai
Rain (opz.086R)

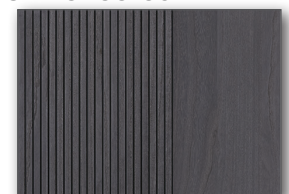

Paulownia Grigio Acai Rain
Mix (opz.086M)

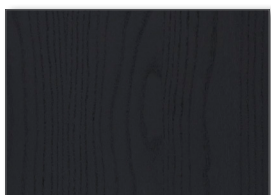

Paulownia Nero
(opz.087)

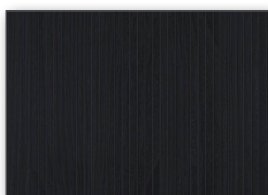

Paulownia Nero Rain
(opz.087R)

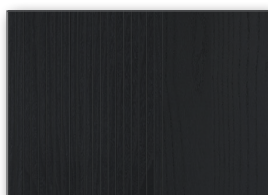

Paulownia Nero Rain
Mix (opz.087M)

Impiallacciato Paulownia Paulownia Veneered

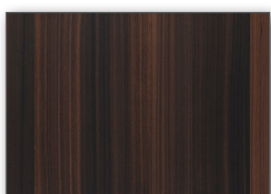

Eucalpto Affumicato
(opz.4851)

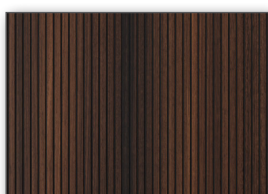

Eucalpto affumicato
Rain (opz.4851R)

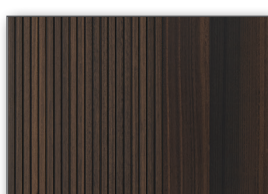

Eucalpto affumicato
Rain Mix (opz.4851M)

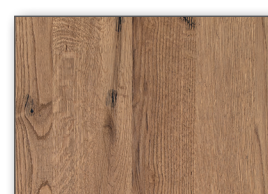

Rovere Mielato
Invecchiato (opz.5383)



Rovere Madera
Termocotto (opz.5388)

Impiallacciato Eucalpto Eucalpto Veneered

Impiallacciato Vintage Vintage Veneered



Arizona Ash
opz. 2437



Aragona Ash
opz. 2438



Rafia Ash
opz. 2436

Impiallacciato Frassino verniciato a eccimeri
Ash veneered excimer painted



Namib Oak
opz. 5447



Moscato Oak
opz. 5448



Fumè Oak
opz. 5449

Impiallacciato Rovere verniciato a eccimeri
Oak veneered excimer painted





MADE IN ITALY: NORMA UNI 11674

La norma tutela l'acquirente garantendo l'origine italiana e le prestazioni di sicurezza e durata del prodotto, entrambe verificate periodicamente da uno dei più importanti laboratori di prova e certificazione per il legno-arredo in Italia: COSMOB.

MADE IN ITALY: STANDARD UNI 11674

This standard protects purchasers by guaranteeing the Italian origin, safety performance and useful life of products, both periodically verified by one of the leading testing and certification labs for wooden furnishings in Italy: COSMOB.



GREENGUARD

Il Programma di Certificazione GREENGUARD certifica che tutte le strutture dei prodotti a marchio LUBE e CREO sono conformi agli standard più rigorosi in termini di livelli di emissione di Composti Organici Volatili (COV) emessi da mobili, superfici e vernice oltre ad altre sostanze chimiche nocive negli ambienti interni.

GREENGUARD

The GREENGUARD certification programme certifies that all structures of LUBE and CREO products comply with the strictest standards in terms of emissions of volatile organic compounds (VOCs) from furniture, surfaces and coatings, as well as other harmful chemical substances in interior environments.



PANNELLO ECOLOGICO

Le strutture dei mobili LUBE e CREO sono realizzate con pannelli composti da legni riciclati al 100%, certificati dal Consorzio Pannello Ecologico e con materiali a basso impatto ambientale, certificati per la bassa emissione di formaldeide.

ECOLOGICAL PANELS

LUBE and CREO structures are created with panels made from 100% recycled wood, certified by the Eco-Panel Consortium, and from environmentally friendly materials, certified for low formaldehyde emissions.



GRUPPO LUBE ECOLOGIC

Il Gruppo LUBE utilizza per i componenti delle cucine (tutte le strutture, alcune ante e alcuni complementi), materiale conforme al regolamento EPA TSCA TITLE VI, uno dei più severi in merito alle normative di salvaguardia ambientale.

ECOLOGICAL PANELS

The LUBE Group uses for kitchen components (all carcasses, some doors and some accessories), material that complies with the EPA TSCA TITLE VI regulation, one of the strictest regarding environmental protection regulations.



SOSTENIBILITÀ AMBIENTALE

Lube Industries srl è dotata di Sistemi di Gestione per l'Efficienza Ambientale, per la Qualità e per la Salute e la Sicurezza sul Lavoro, in conformità alle norme: UNI EN ISO 14001, UNI EN ISO 9001 e UNI EN ISO 45001.

ENVIRONMENTAL SUSTAINABILITY

Lube Industries S.r.l. implements management systems for environmental efficiency, quality, and occupational health and safety, in conformity to the following standards: UNI EN ISO 14001, UNI EN ISO 9001 and UNI EN ISO 45001.



FSC®

La certificazione FSC® rappresenta il principale meccanismo di garanzia sull'origine del legno o della carta, con questa certificazione Lube Industries ha deciso di rendere noto il suo impegno nei confronti dell'ambiente e si schiera contro il disboscamento incontrollato e il taglio illegale di foreste.

FSC®

FSC® certification is the leading mechanism guaranteeing the origin of wood and paper. With this certification, Lube Industries has decided to demonstrate its commitment to the environment and stand against uncontrolled deforestation and illegal felling.

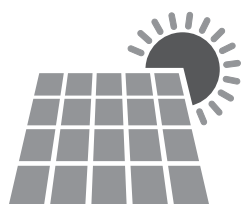

FOTOVOLTAICO

Energia pulita per prodotti di qualità. Un impianto fotovoltaico, installato nella sede aziendale, copre la superficie di 40.800 mq ed eroga una potenza di 6,2 MWp. L'energia prodotta quotidianamente dai pannelli solari, circa 6000 KWh, è in grado di soddisfare il fabbisogno dei processi produttivi aziendali.

PHOTOVOLTAICS

Clean energy for high-quality products. A photovoltaic plant, installed at the company headquarters, covers an area of 40,800 m2 and has a power output of 6.2 MWp. The energy generated daily by the solar panels, approximately 6,000 KWh, is enough to meet the company's production needs.

STRUTTURE

CARCASSES



bianco (opz.001)
schiena e ripiano bianco
(opz.001)
white (opt.001)
white back panel and shelf
(opt.001)



visone (opz.948M)
schiena e ripiano visone
(opz.948M)
mink (opt.948M)
mink back panel and shelf
(opt.948M)

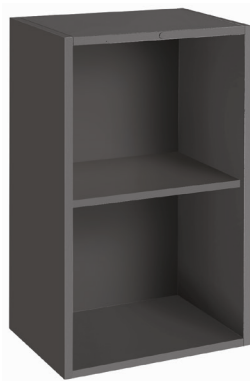

lavagna (opz.9620)
schiena e ripiano lavagna
(opz.9620)
slate grey (opt.9620)
slate grey back panel and shelf
(opt.9620)

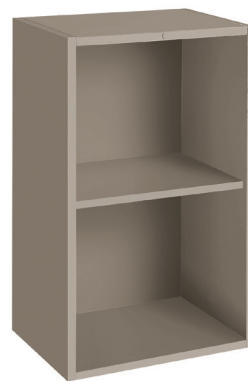

fango (opz.8860)
schiena e ripiano fango
(opz.8860)
mud (opt.8860)
mud back panel and shelf
(opt.8860)

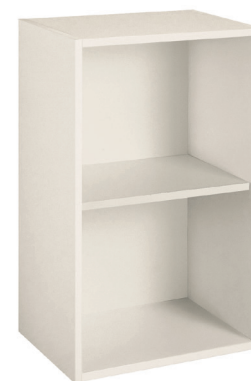

conchiglia (opz.8910)
schiena e ripiano conchiglia
(opz.8910)
shell (opt.8910)
shell back panel and shelf
(opt.8910)

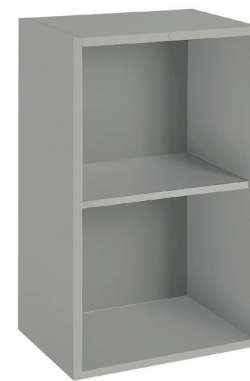

argilla (opz.9690)
schiena e ripiano argilla
(opz.9690)
clay (opt.9690)
clay back panel and shelf
(opt.9690)



MENSOLE P. 31- 61 COME STRUTTURE

D. 31-61 SHELVES AS CARCASSES

MENSOLE P. 31- 61 COME ANTE

D. 31-61 SHELVES AS DOORS



bianco (opz.001)
white (opt.001)

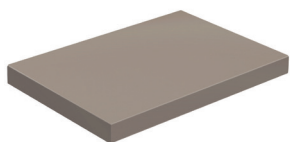

visone (opz.948M)
mink (opt.948M)



impiallacciato
veneered

Per le finiture vedi pagine 32 / 40
For finishes see pages 32 / 40

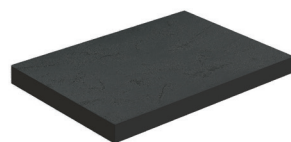

lavagna (opz.9620)
slate grey (opt.9620)

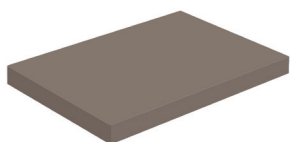

fango (opz.8860)
mud (opt.8860)

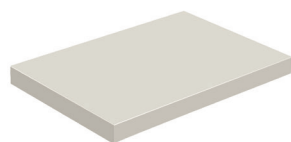

conchiglia (opz.8910)
shell (opt.8910)

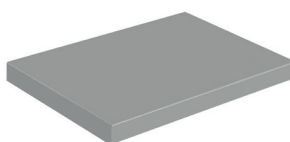

argilla (opz.9690)
clay (opt.9690)

zoccoli in alluminio verniciati a polvere finitura opaca

aluminum plinths height powder coated matt finish

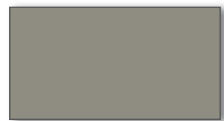

alluminio finitura titanio
verniciato (opz.414V)



di serie H.13

H.13 standard

COLORI FREDDI OPACHI SOFT SOFT MATT COLD COLOURS

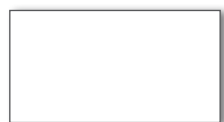

bianco assoluto (opz.740S)

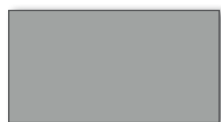

grigio traffico (opz.9511)

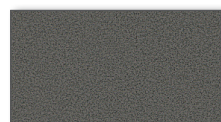

silver dark (opz.9507)

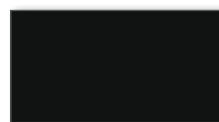

nero (opz.7892)

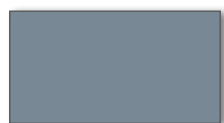

azzurro nube (opz.8379)

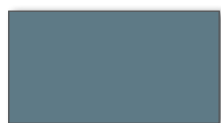

azzurro ottanio (opz.8385)



grigio bromo (opz.9533)

COLORI CALDI OPACHI SOFT SOFT MATT HOT COLOURS

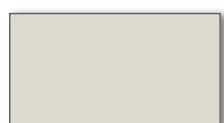

lino (opz.9513)

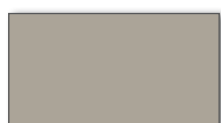

grigio kenya (opz.9501)

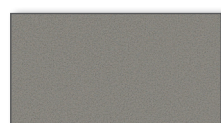

grigio selce (opz.SE)

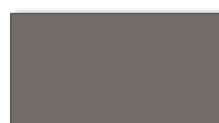

grigio piombo (opz.9537)



terra d'ombra (opz.955T)

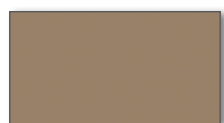

ottone (opz.7761)



umber (opz.955U)



cuoio (opz.8897)



ghisa (opz.9509)



fumo (opz.9531)



giallo digione (opz.8257)

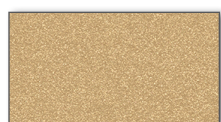

oro (opz.AU)



cotto (opz.8887)



rame (opz.8167)

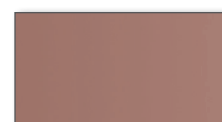

rame brunito (opz.8168)



rosso persia (opz.8165)

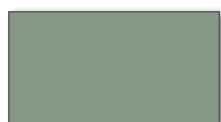

verde celadon (opz.8485)



rosso velvet (opz.8169)

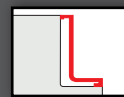

Neck

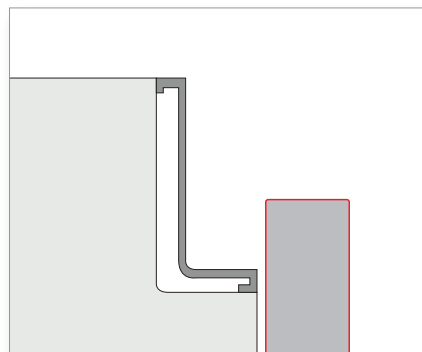

**ANTA SQUADRATA
SENZA PROFILO**
SQUARED DOOR WITHOUT
PROFILE

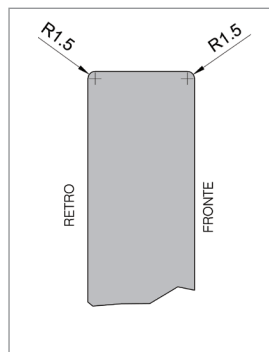

i DETTAGLIO TECNICO
TECHNICAL DETAIL

Easy

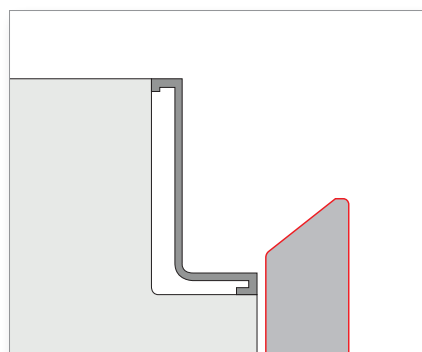

**ANTA INCLINATA
SENZA PROFILO**
INCLINED DOOR WITHOUT
PROFILE

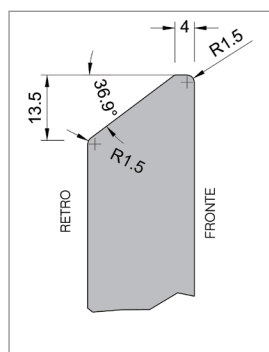

i DETTAGLIO TECNICO
TECHNICAL DETAIL

FINITURE GOLE VERNICIATI A POLVERE OPACHI
MATT FINGER RAILS POWDER COATED FINISHES

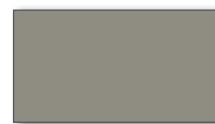

titanio verniciato
(opz.414V)

! di serie
standard

COLORI FREDDI OPACHI SOFT SOFT MATT COLD COLOURS



bianco assoluto (opz.740S)

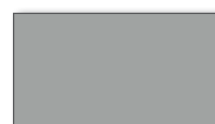

grigio traffico (opz.9511)

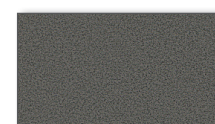

silver dark (opz.9507)



nero (opz.7892)

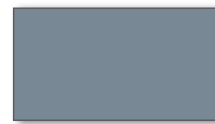

azzurro nube (opz.8379)

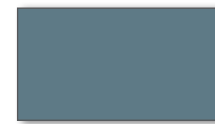

azzurro ottanio (opz.8385)

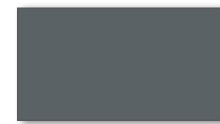

grigio bromo (opz.9533)

COLORI CALDI OPACHI SOFT SOFT MATT HOT COLOURS



lino (opz.9513)



grigio kenya (opz.9501)

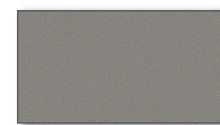

grigio selce (opz.SEL)

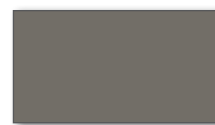

grigio piombo (opz.9537)



terra d'ombra (opz.955T)



umber (opz.955U)

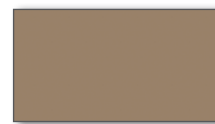

ottone (opz.7761)

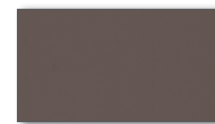

cuoio (opz.8897)

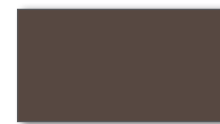

ghisia (opz.9509)



fumo (opz.9531)

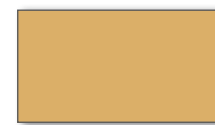

giallo digione (opz.8257)

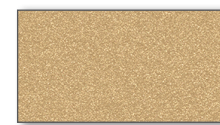

oro (opz.AU)

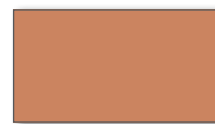

cotto (opz.8887)

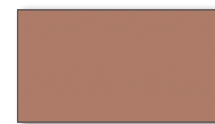

rame (opz.8167)

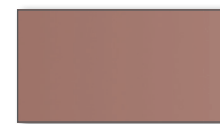

rame brunito (opz.8168)

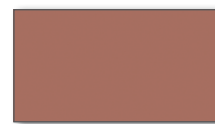

rosso persia (opz.8165)



verde celadon (opz.8485)

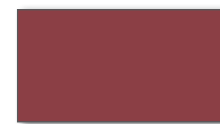

rosso velvet (opz.8169)

Bridge

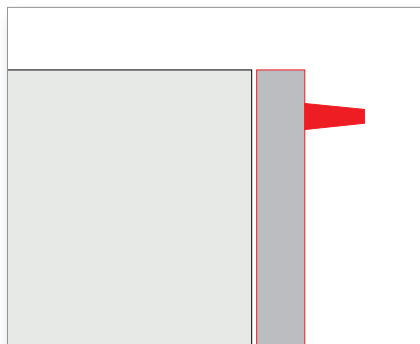

La versione "RAIN" è disponibile nel sistema maniglia "Bridge" solo con una selezione di maniglie verticali nelle colonne. Basi e pensili sempre senza maniglia (vedi pag. 22/27).



The "RAIN" version is available in the handle system "Bridge" only with a selection of vertical handles in columns. Base units and wall units always without handles.





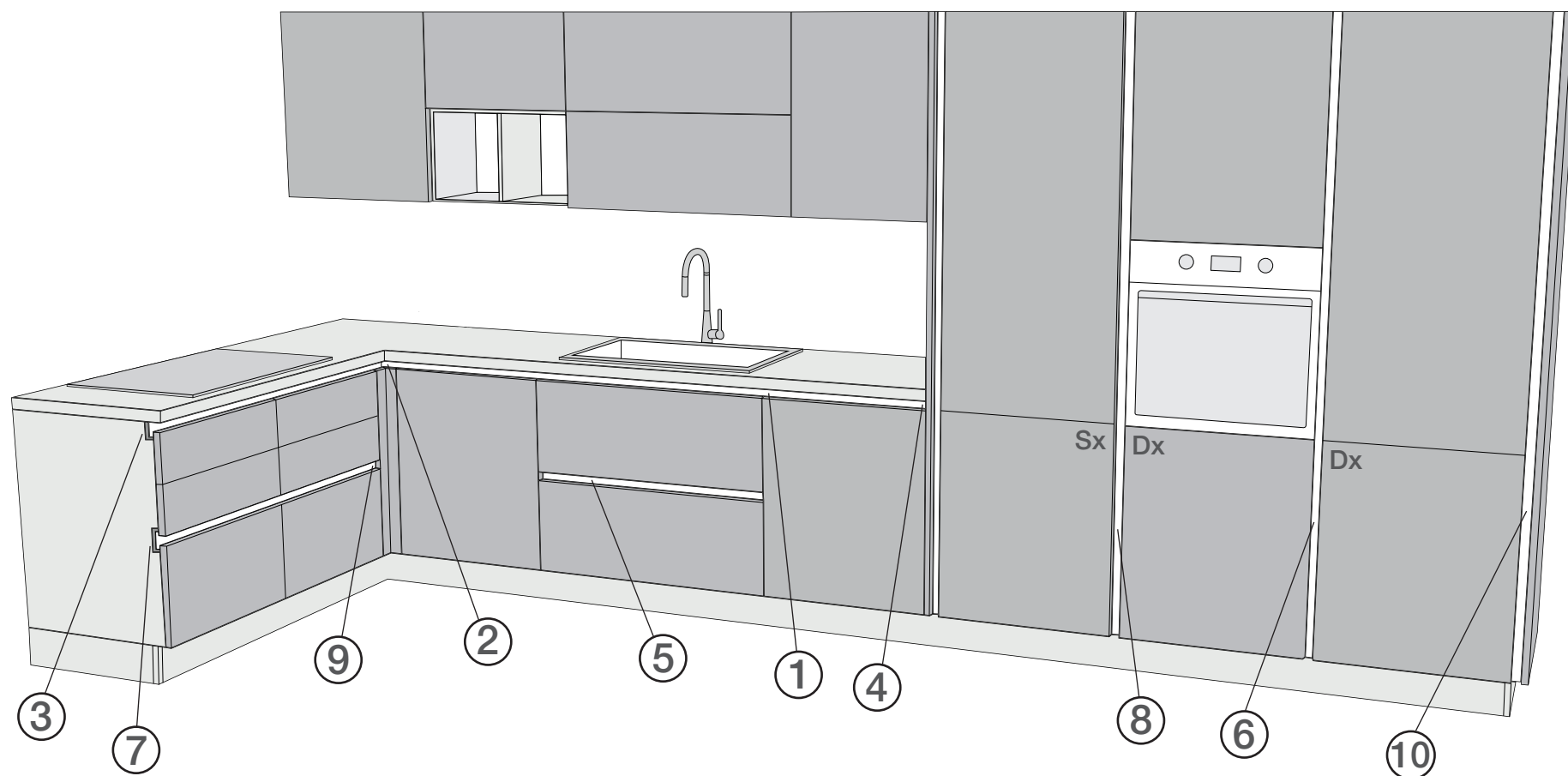
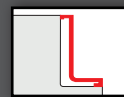

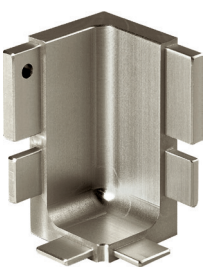
ANTA CON MANIGLIA FRONTALE

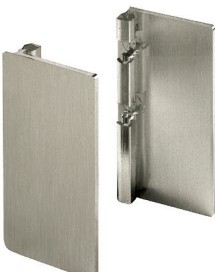
DOOR WITH FRONT HANDLE

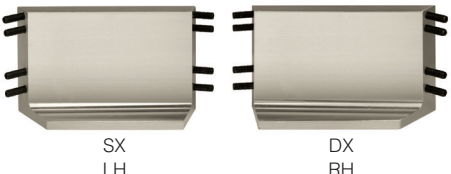
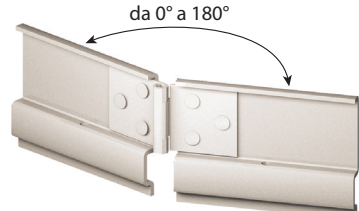



	COD.		COD.
<p>①</p> <p>Gola sottotop tipo "A" Type "A" undermount finger rail</p>  <p>al ml per lm</p>	G950010	<p>②</p> <p>Angolo interno a 90° per gola tipo "A" 90° interior corner for "A" type finger rail</p>  <p>cadauno each</p>	G950050
<p>③</p> <p>Terminale aperto dx o sx per gola tipo "A" da utilizzare a fine composizione in presenza di fianco struttura non rifinito. RH or LH open end for type "A" finger rail to be placed at the end of the composition in presence of unfinished structure side.</p>  <p>terminale DX RH end</p> <p>terminale SX LH end</p>	G950021 G950022	<p>④</p> <p>Terminale chiuso dx o sx per gola tipo "A" da utilizzare solo tra basi e colonne o a fine composizione in presenza di fianco struttura rifinito come anta senza scassi per gola. RH or LH closure for type "A" finger rail to be placed only between base units and column or at the end of the composition in presence of structure side finished as a door without recess for finger rail.</p>  <p>terminale DX RH end</p> <p>terminale SX LH end</p>	G950031 G950032

	COD.			COD.	
<p>Coppia angolari per kit raccordo base angolo 110x110 Obbligatorii Couple corner piece for fitting kit corner base unit 110x110 Obbligatori</p>  <p>SX LH DX RH</p> <p>in alluminio aluminium angolare DX RH corner piece angolare SX LH corner piece</p>				<p>2</p> <p>Angolare con snodo per unione fuori squadra per gola tipo "A" Corner piece with joint for out-of-plumb joining for type "A" finger rail</p>  <p>da 0° a 180°</p>	
	G950058				
	G950059			G950060	
<p>5</p> <p>Gola intermedia tipo "B" Type "B" intermediate finger rail</p>  <p>al ml per lm</p>				<p>6</p> <p>Mezza gola verticale tipo "C" (completa di distanziale) Type "C" half vertical finger rail (complete with spacer)</p>  <p>sezione mezza gola tipo "C" cross section of type "C" finger rail</p> <p>Piedi H 13 H 96 H 132 H 204 H 228</p> <p>Piedi H 6 H 108 H 144 H 216</p>	
	G950110			G950310	
				G950330	
				G950350	
				G950370	
				G950320	
				G950340	
				G950360	
<p>7</p> <p>Terminale aperto dx o sx per gola tipo "B" da utilizzare a fine composizione in presenza di fianco struttura non rifinito. RH or LH open end for type "B" finger rail to be placed at the end of the composition in presence of unfinished structure side.</p>  <p>terminale DX RH end terminale SX LH end</p>				<p>8</p> <p>Gola verticale intermedia tipo "D" (completa di distanziale) Type "D" intermediate vertical finger rail (complete with spacer)</p>  <p>sezione gola tipo "D" cross section of type "D" finger rail</p> <p>Piedi H 13 H 96 H 132 H 204 H 228</p> <p>Piedi H 6 H 108 H 144 H 216</p>	
	G950121			G950410	
	G950122			G950430	
				G950450	
				G950470	
				G950420	
				G950440	
				G950460	
<p>9</p> <p>Terminale chiuso dx o sx per gola tipo "B" da utilizzare solo tra cassettiere e lavastoviglie/colonne o a fine composizione in presenza di fianco struttura rifinito come anta senza scassi per gola. RH or LH closure for type "B" finger rail to be placed only between drawer units and dishwasher/columns or at the end of the composition in presence of structure side finished as a door without recess for finger rail.</p>  <p>terminale DX RH end terminale SX LH end</p>				<p>10</p> <p>Gola verticale laterale tipo "E" (completa di distanziale) Type "E" lateral vertical finger rail (complete with spacer)</p>  <p>sezione gola tipo "E" cross section of type "E" finger rail</p> <p>Piedi H 13 H 96 H 132 H 204 H 228</p> <p>Piedi H 6 H 108 H 144 H 216</p>	
	G950131			G950510	
	G950132			G950530	
				G950550	
				G950570	
				G950520	
				G950540	
				G950560	



VISTA FRONTALE E LATERALE ZOCCOLO H 13 PER BASI H 88

FRONT AND SIDE VIEW PLINTH H 13 FOR BASE UNITS H 88

PROSPETTO LATERALE

Fianco struttura come anta
senza scasso per gola

SIDE VIEW

Structural side as door without
recess for finger rail

PROSPETTO LATERALE

Fianco struttura con scassi per gola

SIDE VIEW

Structural side with recess for finger rail

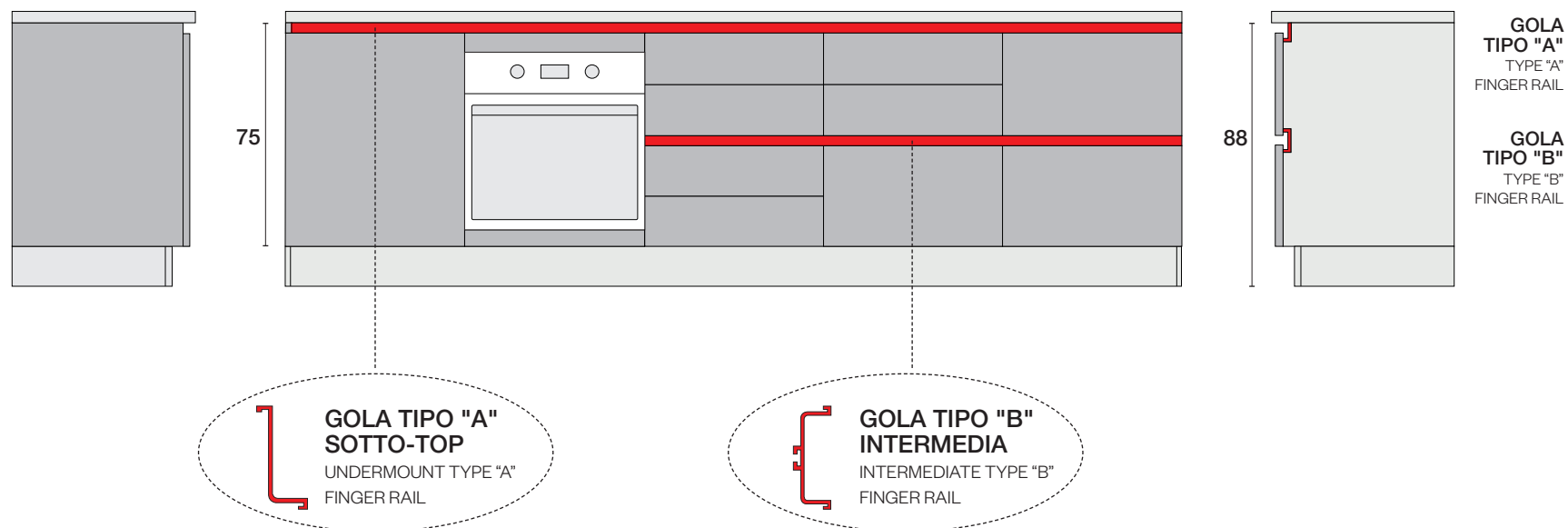

VISTA FRONTALE E LATERALE ZOCCOLO H 6 PER BASI H 90

FRONT AND SIDE VIEW PLINTH H 6 FOR BASE UNITS H 90

PROSPETTO LATERALE

Fianco struttura come anta
senza scasso per gola

SIDE VIEW

Structural side as door without
recess for finger rail

PROSPETTO LATERALE

Fianco struttura con scassi per gola

SIDE VIEW

Structural side with recess for finger rail

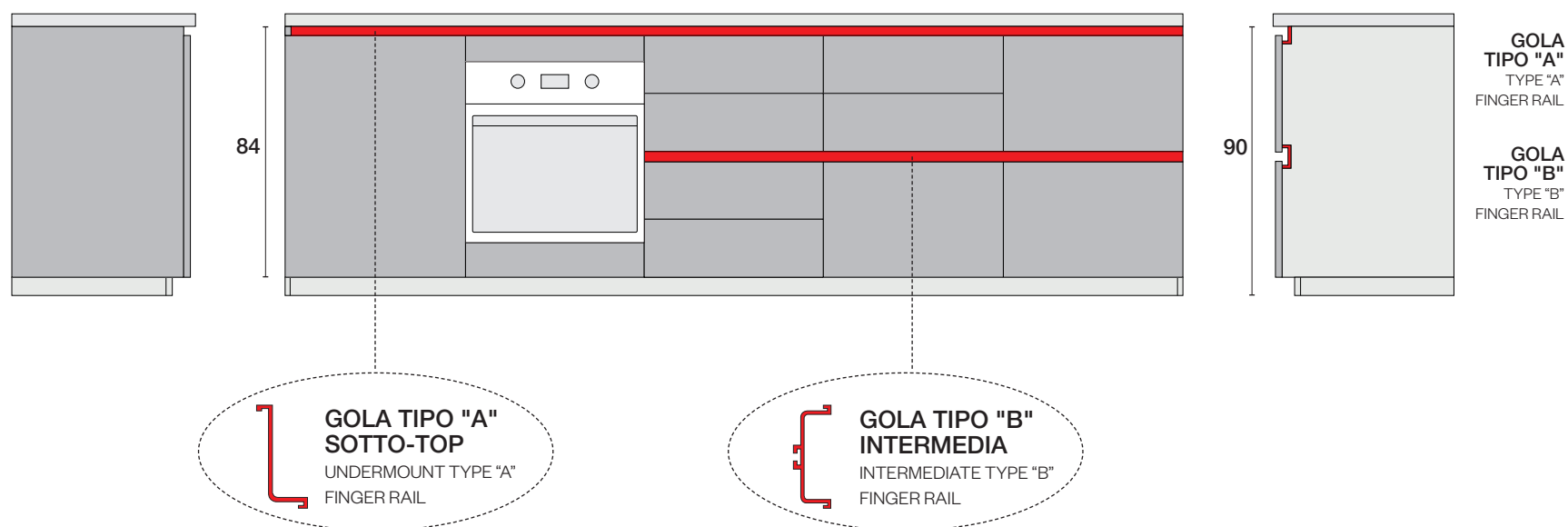



VISTA FRONTALE ZOCCOLO H 13

FRONT VIEW PLINTH H 13

VISTA FRONTALE ZOCCOLO H 6

FRONT VIEW PLINTH H 6

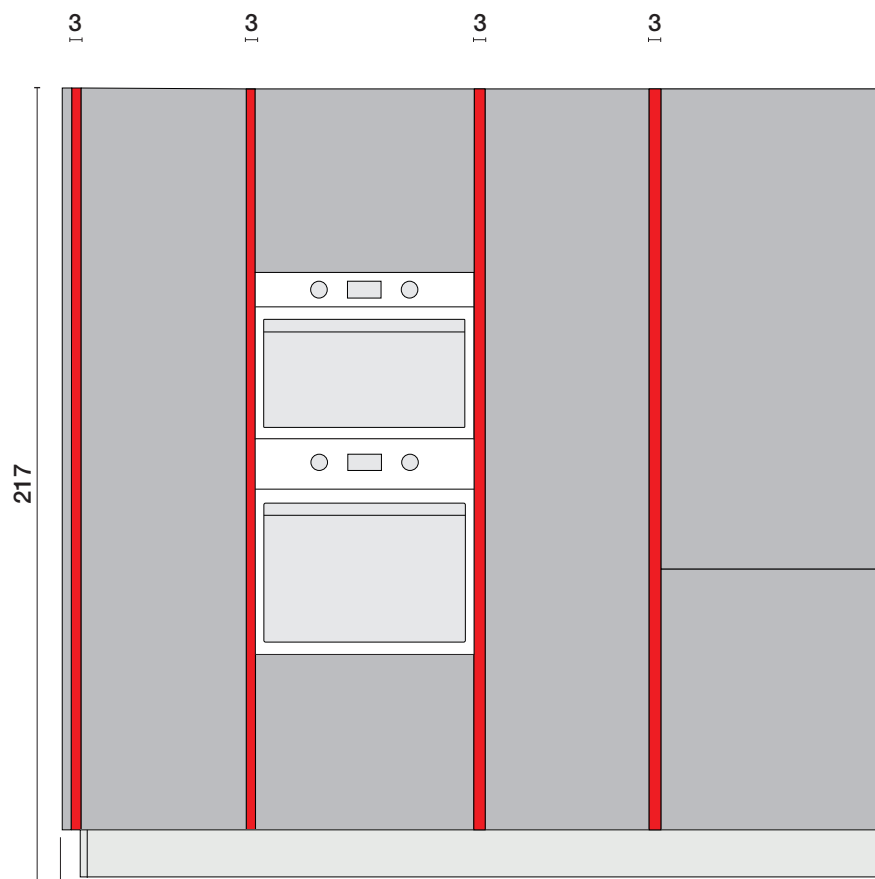

FIANCO RIPORTATO
COME ANTA SP. 23 MM
ADDITIONAL SIDE PANEL
AS DOOR TH. 23 MM

! PER LA VERSIONE EASY SULLE COLONNE
IL PROFILO ANTA È SEMPRE VERTICALE
DOOR PROFILE ON THE COLUMNS FOR
EASY VERSION IS ALWAYS VERTICAL

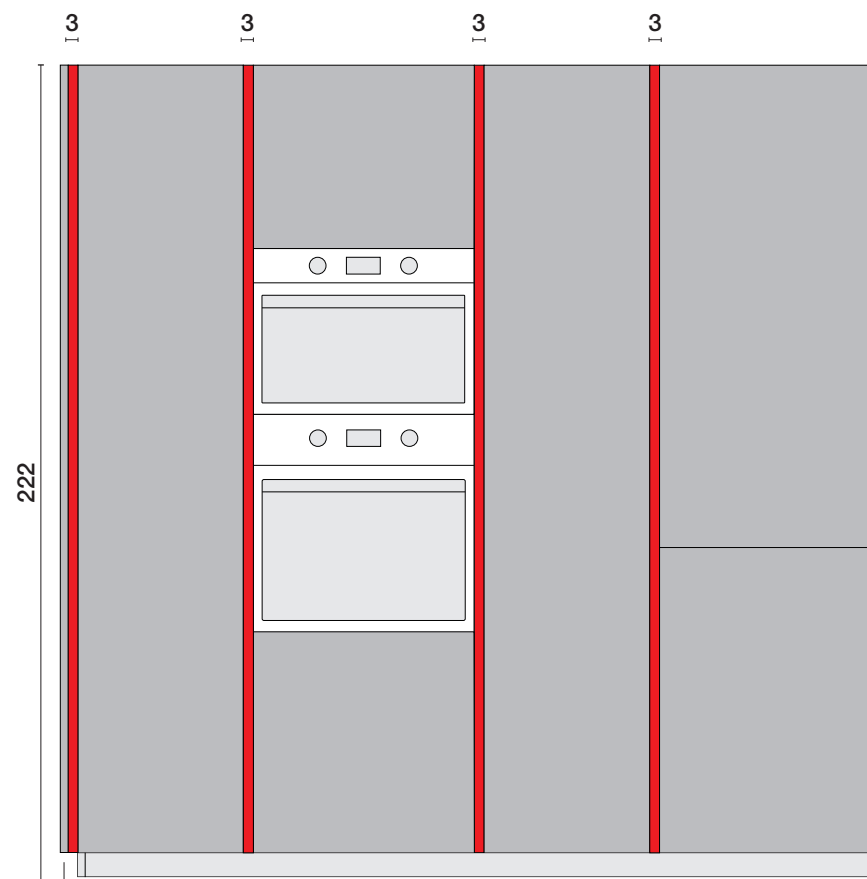

FIANCO RIPORTATO
COME ANTA SP. 23 MM
ADDITIONAL SIDE PANEL
AS DOOR TH. 23 MM

! PER LA VERSIONE EASY SULLE COLONNE
IL PROFILO ANTA È SEMPRE VERTICALE
DOOR PROFILE ON THE COLUMNS FOR
EASY VERSION IS ALWAYS VERTICAL

VISTA DALL'ALTO

TOP VIEW

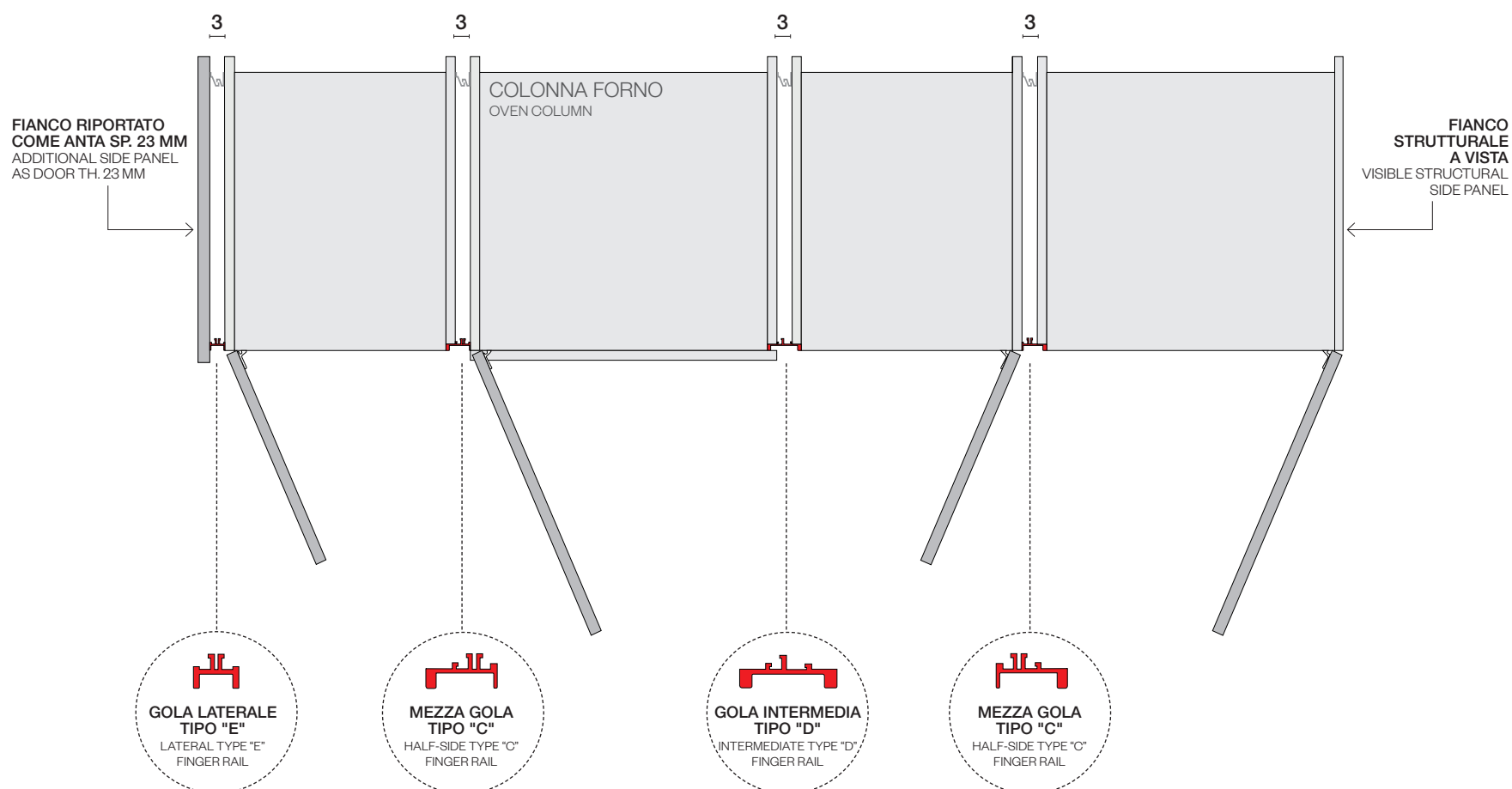



DI SERIE STANDARD



Maniglia 350
Spessore maniglia 35,5 mm
 anta L 15 → passo 160 mm in verticale
 anta da L 30 a L 45 → passo 160 mm
 anta da L 60 a L 120 → passo 320 mm

Handle 350
Handle thickness 35,5 mm
 door W 15 → centre-to-centre distance 160 mm vertical
 door from W 30 to W 45 → centre-to-centre distance 160 mm
 door from W 60 to W 120 → centre-to-centre distance 320 mm

Maniglia 350T finitura acciaio anodizzato
 Handle 350T anodized steel finish

Maniglia 350N finitura nero
 Handle 350N black finish

Maniglie non inseribili su ante "Rain" e su ante "Rain Mix"
 These handles cannot be fitted on "Rain" and "Rain Mix" doors

A RICHIESTA ON REQUEST



Maniglia 60S finitura silver dark
Spessore maniglia 32,5 mm
 anta L 15 → passo 96 mm
 anta L 30 a L 45 → passo 160 mm
 anta da L 60 a L 120 → passo 320 mm

Handle 60S dark silver finish
Handle thickness 32,5 mm
 door W 15 → centre-to-centre distance 96 mm
 door W 30 to W 45 → centre-to-centre distance 160 mm
 door from W 60 to W 120 → centre-to-centre distance 320 mm



Maniglia 60V finitura visone
Spessore maniglia 32,5 mm
 anta L 15 → passo 96 mm
 anta L 30 a L 45 → passo 160 mm
 anta da L 60 a L 120 → passo 320 mm

Handle 60V mink finish
Handle thickness 32,5 mm
 door W 15 → centre-to-centre distance 96 mm
 door W 30 to W 45 → centre-to-centre distance 160 mm
 door from W 60 to W 120 → centre-to-centre distance 320 mm



Maniglia 351B finitura dark brown
Spessore maniglia 30 mm
 anta L 15 → passo 96 mm
 anta L 30 a L 45 → passo 160 mm
 anta da L 60 a L 120 → passo 320 mm

Handle 351B brown dark finish
Handle thickness 30 mm
 door W 15 → centre-to-centre distance 96 mm
 door W 30 to W 45 → centre-to-centre distance 160 mm
 door from W 60 to W 120 → centre-to-centre distance 320 mm



Maniglia 351S finitura silver dark
Spessore maniglia 30 mm
 anta L 15 → passo 96 mm
 anta L 30 a L 45 → passo 160 mm
 anta da L 60 a L 120 → passo 320 mm

Handle 351S silver dark finish
Handle thickness 30 mm
 door W 15 → centre-to-centre distance 96 mm
 door W 30 to W 45 → centre-to-centre distance 160 mm
 door from W 60 to W 120 → centre-to-centre distance 320 mm



Maniglia 351R finitura rame brunito
Spessore maniglia 30 mm
 anta L 15 → passo 96 mm
 anta L 30 a L 45 → passo 160 mm
 anta da L 60 a L 120 → passo 320 mm

Handle 351R brushed copper finish
Handle thickness 30 mm
 door W 15 → centre-to-centre distance 96 mm
 door W 30 to W 45 → centre-to-centre distance 160 mm
 door from W 60 to W 120 → centre-to-centre distance 320 mm



Maniglia 351T finitura titanio
Spessore maniglia 30 mm
 anta L 15 → passo 96 mm
 anta L 30 a L 45 → passo 160 mm
 anta da L 60 a L 120 → passo 320 mm

Handle 351T titanium finish
Handle thickness 30 mm
 door W 15 → centre-to-centre distance 96 mm
 door W 30 to W 45 → centre-to-centre distance 160 mm
 door from W 60 to W 120 → centre-to-centre distance 320 mm



Maniglia 352G finitura oro
Spessore maniglia 32,5 mm/Spessore pomo 30 mm
 anta L 15 → pomo
 anta L 30 a L 45 → passo 160 mm
 anta da L 60 a L 90 → passo 320 mm

Handle 352G gold finish
Handle thickness 32,5 mm/ Knob thickness 30 mm
 door W 15 → knob
 door W 30 to W 45 → centre-to-centre distance 160 mm
 door from W 60 to W 90 → centre-to-centre distance 320 mm



Maniglia 352R finitura rame
Spessore maniglia 32,5 mm/Spessore pomo 30 mm
 anta L 15 → pomo
 anta L 30 a L 45 → passo 160 mm
 anta da L 60 a L 90 → passo 320 mm

Handle 352R copper finish
Handle thickness 32,5 mm/ Knob thickness 30 mm
 door W 15 → knob
 door W 30 to W 45 → centre-to-centre distance 160 mm
 door from W 60 to W 90 → centre-to-centre distance 320 mm

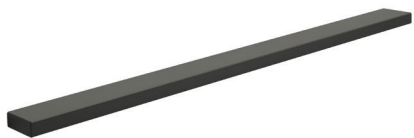

Maniglia 59S finitura anodizzato silver dark
Spessore maniglia 25 mm
 anta L 15 → passo 32 mm
 anta L 30 a L 45 → passo 160 mm
 anta da L 60 a L 120 → passo 448 mm

Handle 59S oxidized dark silver finish
Handle thickness 25 mm
 door W 15 → centre-to-centre distance 32 mm
 door W 30 to W 45 → centre-to-centre distance 160 mm
 door from W 60 to W 120 → centre-to-centre distance 448 mm

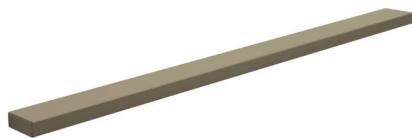

Maniglia 59BA finitura anodizzato bronzo anticato
Spessore maniglia 25 mm
 anta L 15 → passo 32 mm
 anta L 30 a L 45 → passo 160 mm
 anta da L 60 a L 120 → passo 448 mm

Handle 59BA oxidized antiqued bronze finish
Handle thickness 25 mm
 door W 15 → centre-to-centre distance 32 mm
 door W 30 to W 45 → centre-to-centre distance 160 mm
 door from W 60 to W 120 → centre-to-centre distance 448 mm

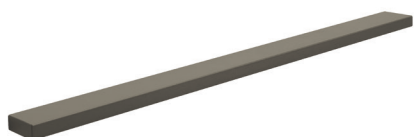

Maniglia 59BB finitura anodizzato titanio
Spessore maniglia 25 mm
 anta L 15 → passo 32 mm
 anta L 30 a L 45 → passo 160 mm
 anta da L 60 a L 120 → passo 448 mm

Handle 59BB oxidized titanium finish
Handle thickness 25 mm
 door W 15 → centre-to-centre distance 32 mm
 door W 30 to W 45 → centre-to-centre distance 160 mm
 door from W 60 to W 120 → centre-to-centre distance 448 mm



Maniglia 59N finitura anodizzato nero
Spessore maniglia 25 mm
 anta L 15 → passo 32 mm
 anta L 30 a L 45 → passo 160 mm
 anta da L 60 a L 120 → passo 448 mm

Handle 59N oxidized black finish
Handle thickness 25 mm
 door W 15 → centre-to-centre distance 32 mm
 door W 30 to W 45 → centre-to-centre distance 160 mm
 door from W 60 to W 120 → centre-to-centre distance 448 mm

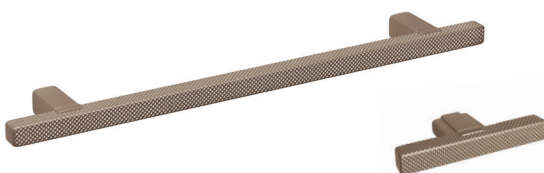

Maniglia 57BA finitura bronzo anticato
Spessore maniglia e pomo 28 mm
 anta L 15 → passo 12 mm
 anta L 30 a L 45 → passo 160 mm
 anta da L 60 a L 90 → passo 320 mm

Handle 57BA antiqued bronze finish
Handle thickness and knob 28 mm
 door W 15 → centre-to-centre distance 12 mm
 door W 30 to W 45 → centre-to-centre distance 160 mm
 door from W 60 to W 90 → centre-to-centre distance 320 mm

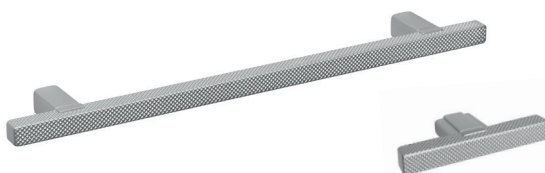

Maniglia 57K finitura acciaio
Spessore maniglia e pomo 28 mm
 anta L 15 → passo 12 mm
 anta L 30 a L 45 → passo 160 mm
 anta da L 60 a L 90 → passo 320 mm

Handle 57K steel finish
Handle thickness and knob 28 mm
 door W 15 → centre-to-centre distance 12 mm
 door W 30 to W 45 → centre-to-centre distance 160 mm
 door from W 60 to W 90 → centre-to-centre distance 320 mm

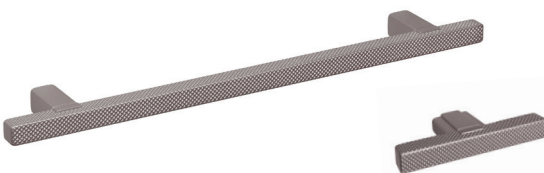

Maniglia 57BB finitura bronzo brunito
Spessore maniglia e pomo 28 mm
 anta L 15 → passo 12 mm
 anta L 30 a L 45 → passo 160 mm
 anta da L 60 a L 90 → passo 320 mm

Handle 57BB burnished bronze finish
Handle thickness and knob 28 mm
 door W 15 → centre-to-centre distance 12 mm
 door W 30 to W 45 → centre-to-centre distance 160 mm
 door from W 60 to W 90 → centre-to-centre distance 320 mm

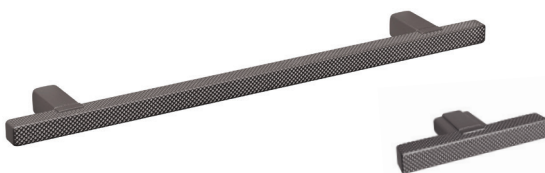

Maniglia 57F finitura grafite
Spessore maniglia e pomo 28 mm
 anta L 15 → passo 12 mm
 anta L 30 a L 45 → passo 160 mm
 anta da L 60 a L 90 → passo 320 mm

Handle 351B graphite finish
Handle thickness and knob 28 mm
 door W 15 → centre-to-centre distance 12 mm
 door W 30 to W 45 → centre-to-centre distance 160 mm
 door from W 60 to W 90 → centre-to-centre distance 320 mm



 Maniglie non inseribili su ante "Rain" e su ante "Rain Mix"
These handles cannot be fitted on "Rain" and "Rain Mix" doors



Maniglia M30N0 finitura nero opaco
Spessore maniglia 42 mm
passo in funzione dell'anta
vedi disegno tecnico

Handle M30N0 matt black finish
Handle thickness 42 mm
centre-to-centre distance varies according
to the door size, see technical drawing

DISEGNO TECNICO MANIGLIA HANDLE TECHNICAL DRAWING

Angolo pensile a libro
Book hanging corner

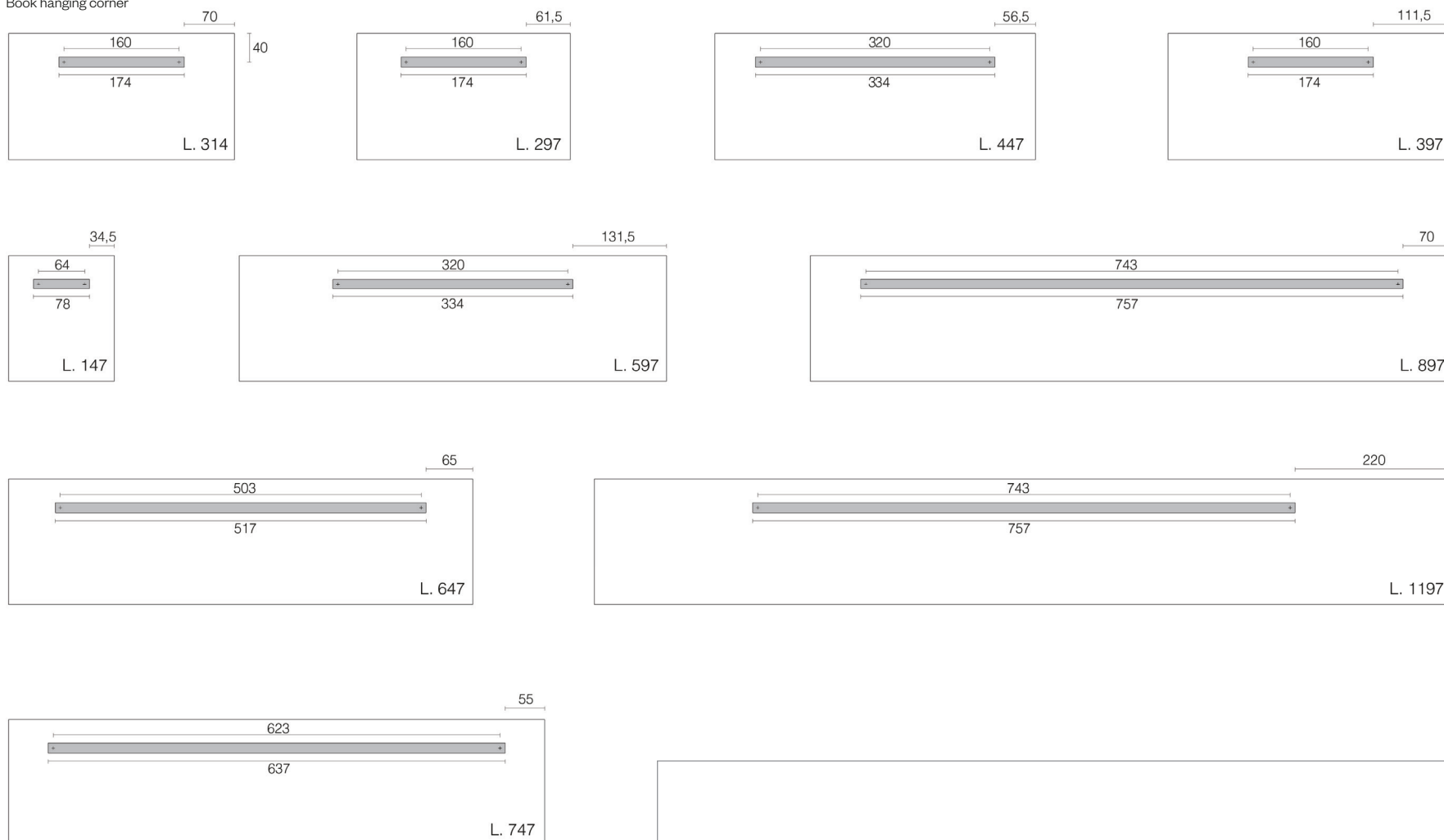

MANIGLIA HANDLE passo 64 mm
MANIGLIA HANDLE passo 160 mm
MANIGLIA HANDLE passo 320 mm
MANIGLIA HANDLE passo 503 mm
MANIGLIA HANDLE passo 623 mm
MANIGLIA HANDLE passo 743 mm



Maniglia M31KO finitura satinato spazzolato
Spessore maniglia 35,5 mm
 passo in funzione dell'anta
 vedi disegno tecnico

Handle M31KO satin brushed finish
Handle thickness 35,5 mm
 centre-to-centre distance varies according
 to the door size, see technical drawing

DISEGNO TECNICO MANIGLIA HANDLE TECHNICAL DRAWING

Angolo pensile a libro
 Book hanging corner

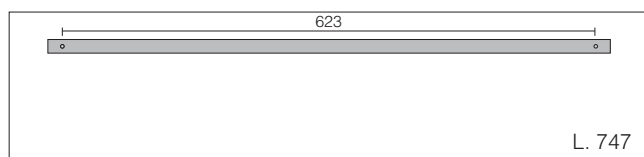
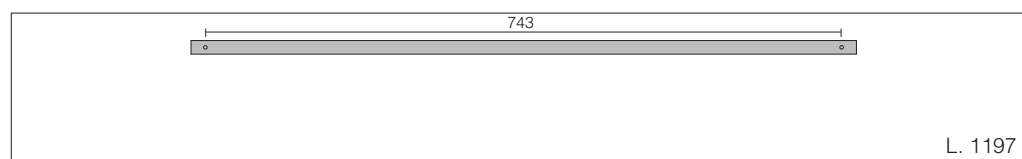
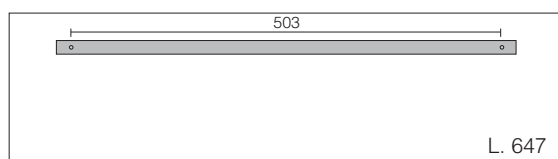
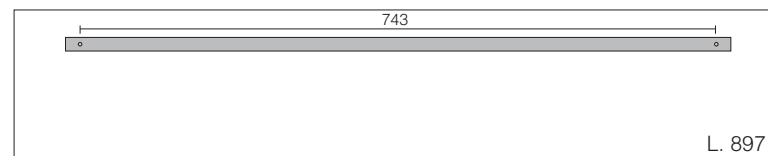
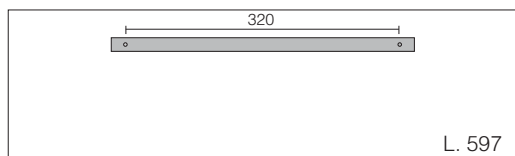
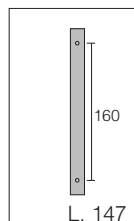
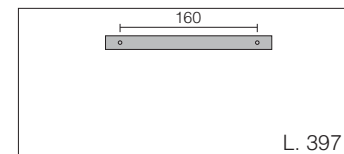
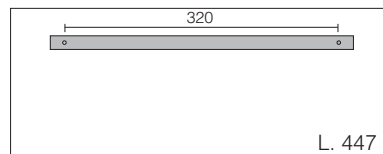
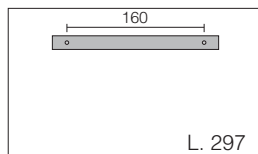
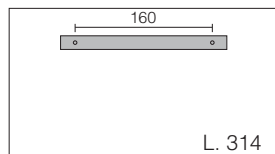

MANIGLIA HANDLE passo 160 mm
 MANIGLIA HANDLE passo 320 mm
 MANIGLIA HANDLE passo 503 mm
 MANIGLIA HANDLE passo 623 mm
 MANIGLIA HANDLE passo 743 mm

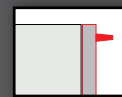

MANIGLIA VERTICALE VERTICAL HANDLE

 Maniglie non inseribili su ante "Rain" e su ante "Rain Mix"
These handles cannot be fitted on "Rain" and "Rain Mix" doors



Maniglia M30NV finitura nero opaco
Spessore maniglia 42 mm
passo in funzione dell'anta, vedi disegno tecnico
Handle M30NV matt black finish
Handle thickness 42 mm
centre-to-centre distance varies according to the door, see technical drawing

 La maniglia verticale non è disponibile per tutti gli elementi. Non inseribile su pensili, basi ed elementi fuori misura
The vertical handle is not compatible with all the elements. Is not possible to insert it on the wall units, base units and oversized elements

MANIGLIA HANDLE	L. 39,7	passo 383 mm
MANIGLIA HANDLE	L. 51,7	passo 503 mm
MANIGLIA HANDLE	L. 63,7	passo 623 mm
MANIGLIA HANDLE	L. 75,7	passo 743 mm
MANIGLIA HANDLE	L. 123,7	passo 623/600 mm
MANIGLIA HANDLE	L. 135,7	passo 743/600 mm
MANIGLIA HANDLE	L. 195,7	passo 623/697/623 mm
MANIGLIA HANDLE	L. 207,7	passo 623/697/743 mm

DISEGNO TECNICO MANIGLIA HANDLE TECHNICAL DRAWING

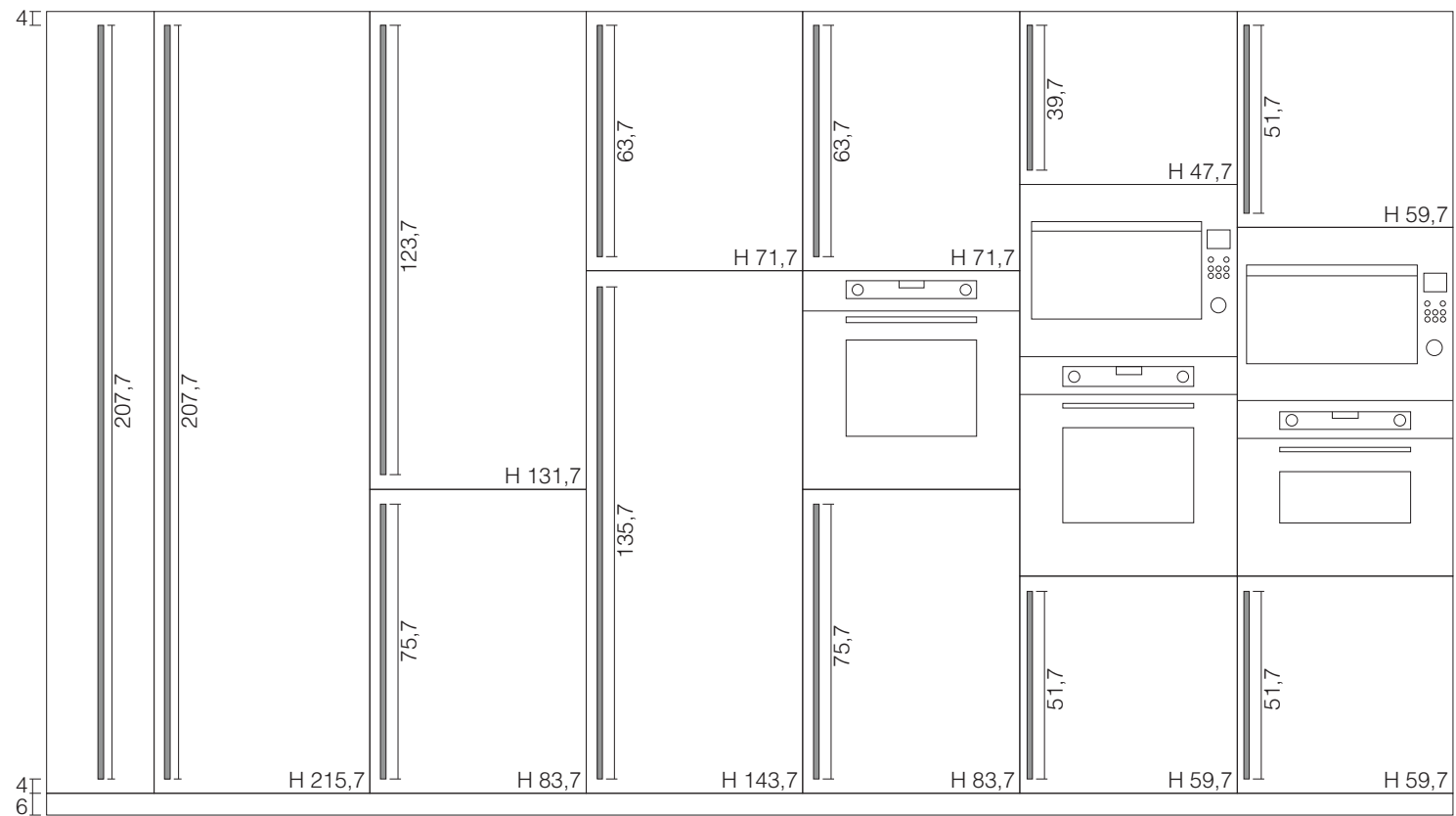

 La maniglia verticale è disponibile anche per colonne con anta fino a terra, mantenendo lo stesso allineamento dall'alto riportato nei disegni tecnici.
 The vertical handle is also available for columns with door down the ground while maintaining the same alignment from above shown in the technical drawings.



MANIGLIA VERTICALE VERTICAL HANDLE

 Maniglie non inseribili su ante "Rain" e su ante "Rain Mix"
These handles cannot be fitted on "Rain" and "Rain Mix" doors



Maniglia M31KV finitura satinato spazzolato

Spessore maniglia 35,5 mm

passo in funzione dell'anta, vedi disegno tecnico

Handle M31KV satin brushed finish

Handle thickness 35,5 mm

centre-to-centre distance varies according to the door, see technical drawing

MANIGLIA HANDLE	L. 41,7	passo 383 mm
MANIGLIA HANDLE	L. 53,7	passo 503 mm
MANIGLIA HANDLE	L. 65,7	passo 623 mm
MANIGLIA HANDLE	L. 77,7	passo 743 mm
MANIGLIA HANDLE	L. 125,7	passo 623/600 mm
MANIGLIA HANDLE	L. 137,7	passo 743/600 mm
MANIGLIA HANDLE	L. 197,7	passo 623/697/623 mm
MANIGLIA HANDLE	L. 209,7	passo 623/697/743 mm

 La maniglia verticale non è disponibile per tutti gli elementi. Non inseribile su pensili, basi ed elementi fuori misura.
The vertical handle is not compatible with all the elements. Is not possible to insert it on the wall units, base units and oversized elements

DISEGNO TECNICO MANIGLIE HANDLES TECHNICAL DRAWING

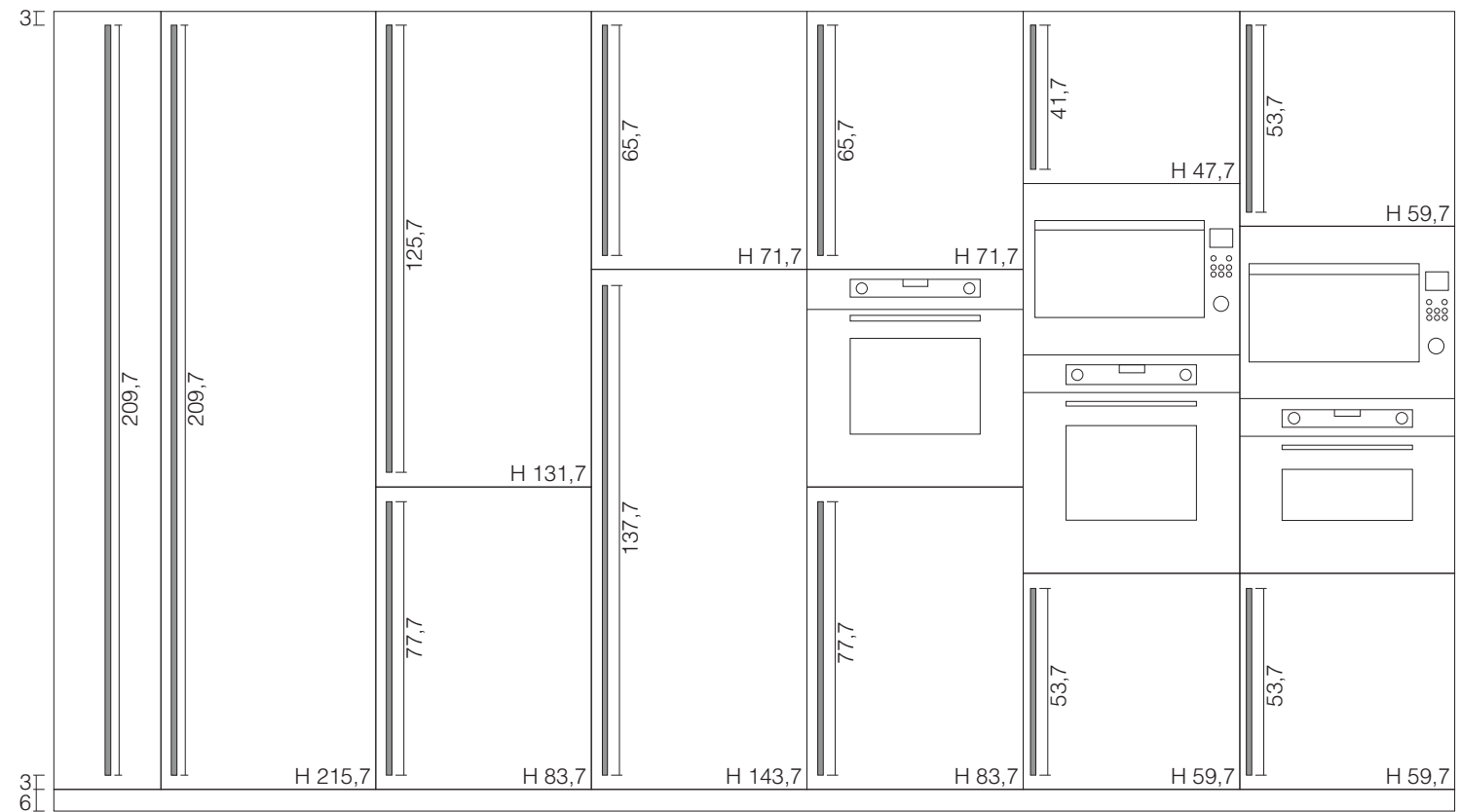
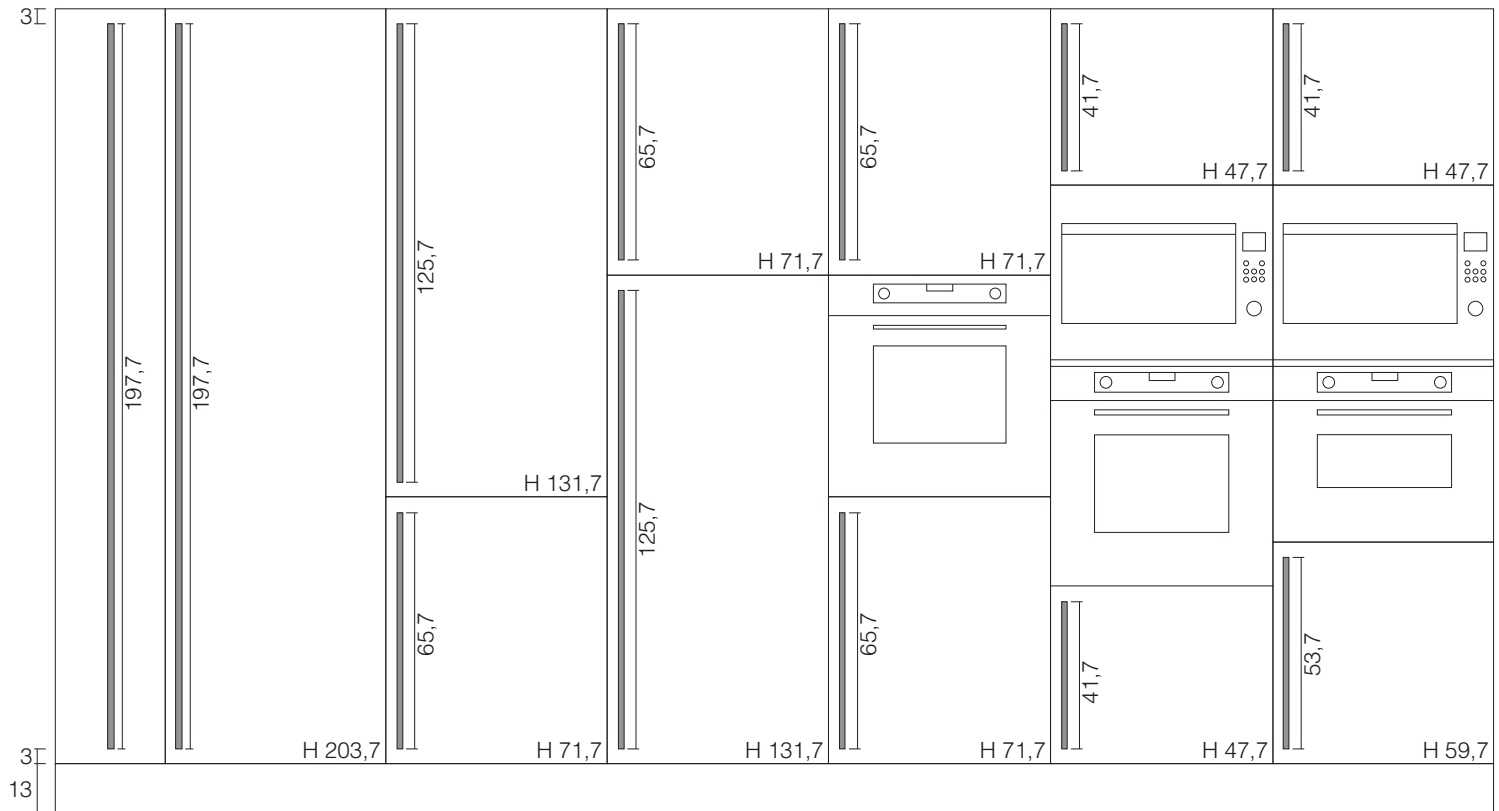

 La maniglia verticale è disponibile anche per colonne con anta fino a terra, mantenendo lo stesso allineamento dall'alto riportato nei disegni tecnici.
The vertical handle is also available for columns with door down the ground while maintaining the same alignment from above shown in the technical drawings.

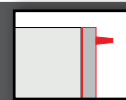

MANIGLIA ORIZZONTALE HORIZONTAL HANDLE



Maniglia M33
Spessore maniglia 40 mm
passo in funzione dell'anta
vedi disegno tecnico

Handle M33
Handle thickness 40 mm
centre-to-centre distance varies according
to the door size, see technical drawing

FINITURE DISPONIBILI AVAILABLE FINISHES



nero M33N

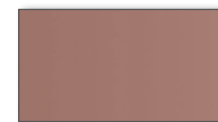

rame brunito M33R

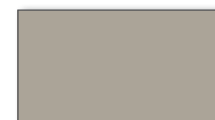

titanio M33T



umber M33U



silver dark M33S

MANIGLIA VERTICALE VERTICAL HANDLE



Maniglia M33
Spessore maniglia 40 mm
passo in funzione dell'anta
vedi disegno tecnico

Handle M33
Handle thickness 40 mm
centre-to-centre distance varies according
to the door size, see technical drawing

MANIGLIA HANDLE passo 198 mm
MANIGLIA HANDLE passo 438 mm
MANIGLIA HANDLE passo 1038 mm
MANIGLIA HANDLE passo 1549 mm

i DETTAGLIO POSIZIONAMENTO
MANIGLIA SU COLONNE CON
ANTA "RAIN"
HANDLE POSITIONING DETAIL
ON "RAIN" DOOR COLUMNS

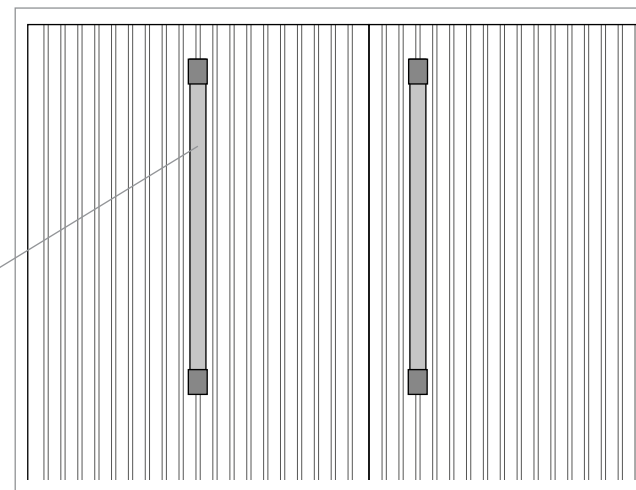
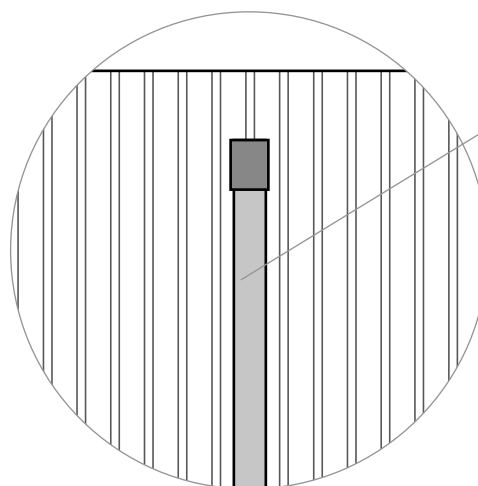

COLONNA LAVASTOVIGLIE
RIALZATA
RAISED DISHWASHERS COLUMN

COLONNE BATTENTI
LEFT AND RIGHT DOORS COLUMNS



La maniglia M33 non è inseribile nelle basi e nei pensili con anta "Rain" e "Rain Mix". In presenza di queste tipologie di anta, la maniglia è inseribile solo in verticale sulle colonne. Le basi con anta "Rain" e con anta "Rain Mix" sono disponibili nel sistema maniglia "BRIDGE" solo in versione Push-Pull e Tip-On oppure con gola nel sistema NECK.

The M33 handle cannot be inserted in base and wall units with 'Rain' and 'Rain Mix' doors. With these door types, the handle can only be inserted vertically on columns. Base units with 'Rain' and 'Rain Mix' doors are available in the 'BRIDGE' system only in Push-Pull and Tip-On versions or with finger rail in the NECK system.



La maniglia verticale non è disponibile per tutti gli elementi. Non inseribile su pensili, basi (esclusa L.15) ed elementi fuori misura
The vertical handle is not compatible with all the elements. Is not possible to insert it on the wall units, base units (excluding L.15) and oversized elements

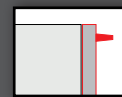

MANIGLIA ORIZZONTALE HORIZONTAL HANDLE



Maniglia M35
Spessore maniglia 40 mm
passo in funzione dell'anta
vedi disegno tecnico

Handle M35
Handle thickness 40 mm
centre-to-centre distance varies according
to the door size, see technical drawing

i Supporti maniglia in alluminio e barra in legno possono essere abbinati a piacere combinandoli in qualsiasi finitura. **Esempio: M35BR**
Aluminum handle supports and wooden handle bar can be matched as desired by combining them in any finish. **Example: M35BR**

FINITURE DISPONIBILI PER BARRA IN LEGNO AVAILABLE FINISHES FOR WOODEN HANDLE BAR



rovere moon M35M



rovere tarmac M35T



rovere nordico M35A

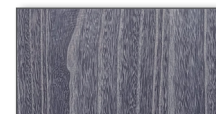

paulownia grigio acai M35G



rovere curry M35C



paulownia nero M35N



rovere brandy M35B



paulownia toffee M35F



rovere torba M35R



eucalipto affumicato M35E

FINITURE DISPONIBILI PER SUPPORTI IN ALLUMINIO AVAILABLE FINISHES FOR ALUMINUM SUPPORTS



nero N

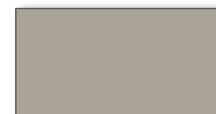

titanio T



silver dark S



rame brunito R



umber U

MANIGLIA VERTICALE VERTICAL HANDLE



Maniglia M35
Spessore maniglia 40 mm
passo in funzione dell'anta
vedi disegno tecnico

Handle M35
Handle thickness 40 mm
centre-to-centre distance varies according
to the door size, see technical drawing

MANIGLIA HANDLE passo 198 mm
MANIGLIA HANDLE passo 438 mm
MANIGLIA HANDLE passo 1038 mm
MANIGLIA HANDLE passo 1549 mm

i **DETTAGLIO POSIZIONAMENTO
MANIGLIA SU COLONNE CON
ANTA "RAIN"**
HANDLE POSITIONING DETAIL
ON "RAIN" DOOR COLUMNS

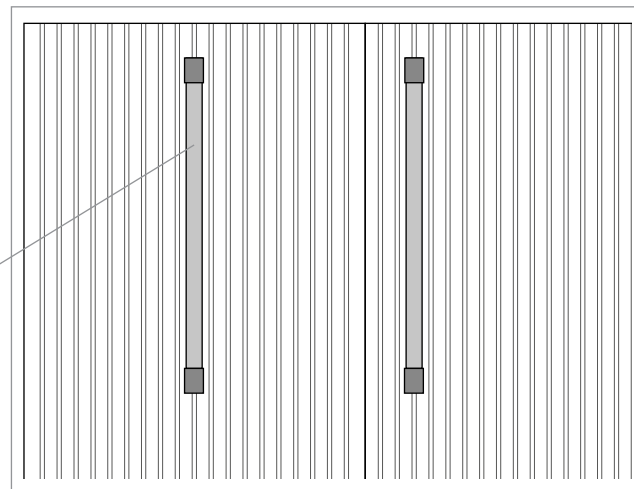
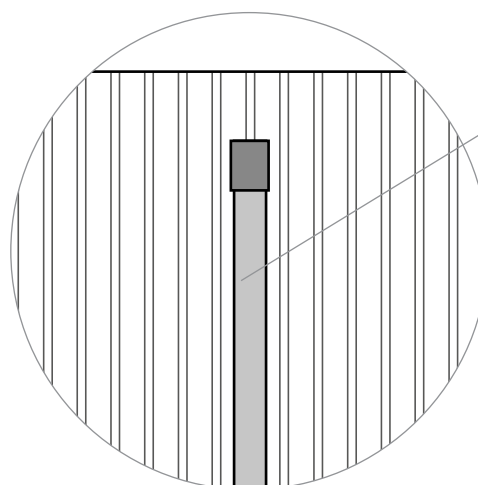

COLONNA LAVASTOVIGLIE
RIALZATA
RAISED DISHWASHERS COLUMN

COLONNE BATTENTI
LEFT AND RIGHT DOORS COLUMNS



La maniglia M35 non è inseribile nelle basi e nei pensili con anta "Rain" e "Rain Mix". In presenza di queste tipologie di anta, la maniglia è inseribile solo in verticale sulle colonne. Le basi con anta "Rain" e con anta "Rain Mix" sono disponibili nel sistema maniglia "BRIDGE" solo in versione Push-Pull e Tip-On oppure con gola nel sistema NECK.

The M35 handle cannot be inserted in base and wall units with 'Rain' and 'Rain Mix' doors. With these door types, the handle can only be inserted vertically on columns. Base units with 'Rain' and 'Rain Mix' doors are available in the 'BRIDGE' system only in Push-Pull and Tip-On versions or with finger rail in the NECK system.

DISEGNO TECNICO MANIGLIE HANDLES TECHNICAL DRAWING

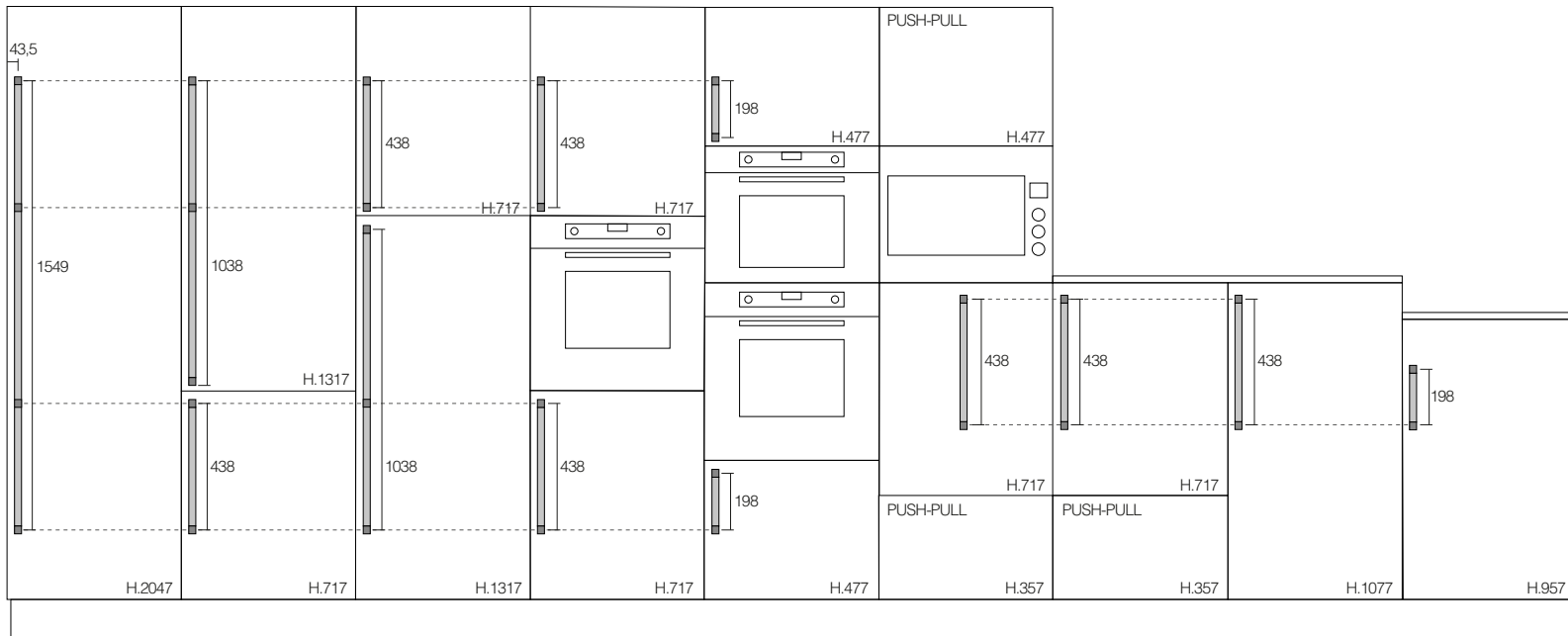

COLONNE ZOCCOLO H.13
H.13 PLINTH COLUMNS

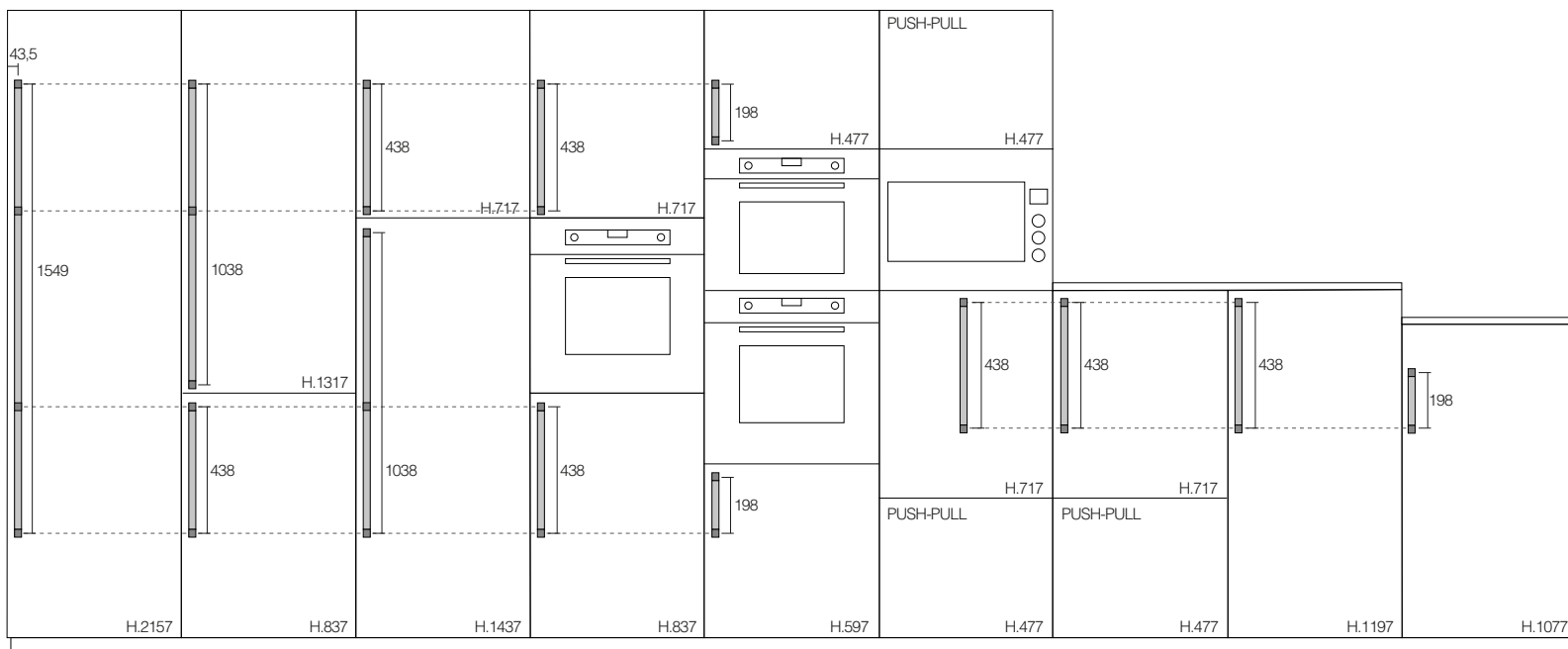

COLONNE ZOCCOLO H.6
H.6 PLINTH COLUMNS

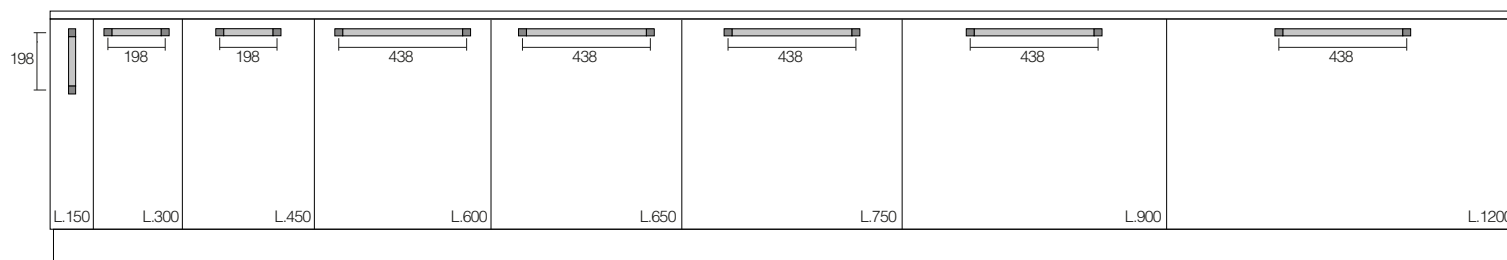

BASI ZOCCOLO H.6 e H.13
H.6 and H.13 BASE UNITS

⊘ Maniglia non inseribile su basi con anta "Rain" e con anta "Rain Mix", disponibili solo Push-Pull e Tip-On.
Handle not available for base units with 'Rain' door and with 'Rain Mix' door, only available in Push-Pull and Tip-On versions.

⚠ La maniglia verticale è disponibile anche per colonne con anta fino a terra, mantenendo lo stesso allineamento dall'alto riportato nei disegni tecnici.
The vertical handle is also available for columns with door down the ground while maintaining the same alignment from above shown in the technical drawings.

⚠ La maniglia verticale non è disponibile per tutti gli elementi. Non inseribile su pensili, basi (esclusa L.15) ed elementi fuori misura
The vertical handle is not compatible with all the elements. Is not possible to insert it on the wall units, base units (excluding L.15) and oversized elements

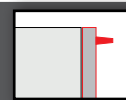

MANIGLIA ORIZZONTALE HORIZONTAL HANDLE



Maniglia M34
Spessore maniglia 36 mm
passo in funzione dell'anta
vedi disegno tecnico

Handle M34
Handle thickness 36 mm
centre-to-centre distance varies according
to the door size, see technical drawing

FINITURE DISPONIBILI AVAILABLE FINISHES



nero M34N

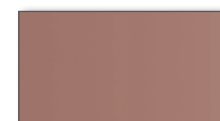

rame brunito M34R



titanio M34T



umber M34U



silver dark M34S

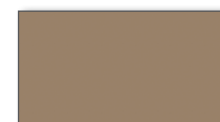

ottone M34O

MANIGLIA VERTICALE VERTICAL HANDLE



Maniglia M34
Spessore maniglia 36 mm
passo in funzione dell'anta
vedi disegno tecnico

Handle M34
Handle thickness 36 mm
centre-to-centre distance varies according
to the door size, see technical drawing

MANIGLIA HANDLE passo 196 mm
MANIGLIA HANDLE passo 436 mm
MANIGLIA HANDLE passo 1036 mm
MANIGLIA HANDLE passo 1547 mm

i DETTAGLIO POSIZIONAMENTO
MANIGLIA SU COLONNE CON
ANTA "RAIN"
HANDLE POSITIONING DETAIL
ON "RAIN" DOOR COLUMNS

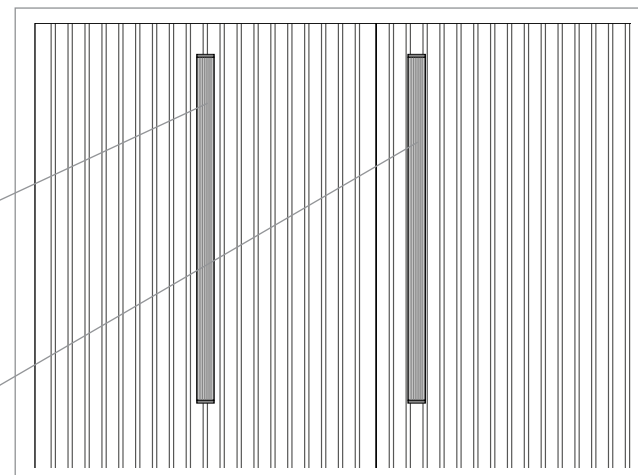
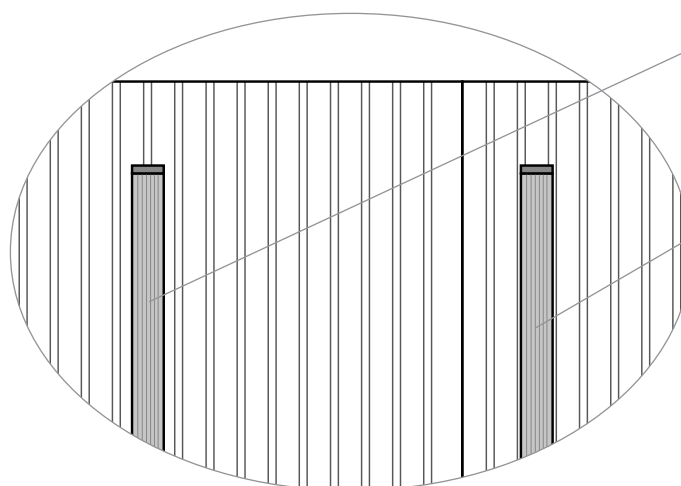

COLONNA LAVASTOVIGLIE
RIALZATA
RAISED DISHWASHERS COLUMN

COLONNE BATTENTI
LEFT AND RIGHT DOORS COLUMNS



La maniglia M34 non è inseribile nelle basi e nei pensili con anta "Rain" e "Rain Mix". In presenza di queste tipologie di anta, la maniglia è inseribile solo in verticale sulle colonne. Le basi con anta "Rain" e con anta "Rain Mix" sono disponibili nel sistema maniglia "BRIDGE" solo in versione Push-Pull e Tip-On oppure con gola nel sistema NECK.

The M34 handle cannot be inserted in base and wall units with 'Rain' and 'Rain Mix' doors. With these door types, the handle can only be inserted vertically on columns. Base units with 'Rain' and 'Rain Mix' doors are available in the 'BRIDGE' system only in Push-Pull and Tip-On versions or with finger rail in the NECK system.

! La maniglia verticale non è disponibile per tutti gli elementi. Non inseribile su pensili, basi (esclusa L.15) ed elementi fuori misura
The vertical handle is not compatible with all the elements. Is not possible to insert it on the wall units, base units (excluding L.15) and oversized elements

DISEGNO TECNICO MANIGLIE HANDLES TECHNICAL DRAWING

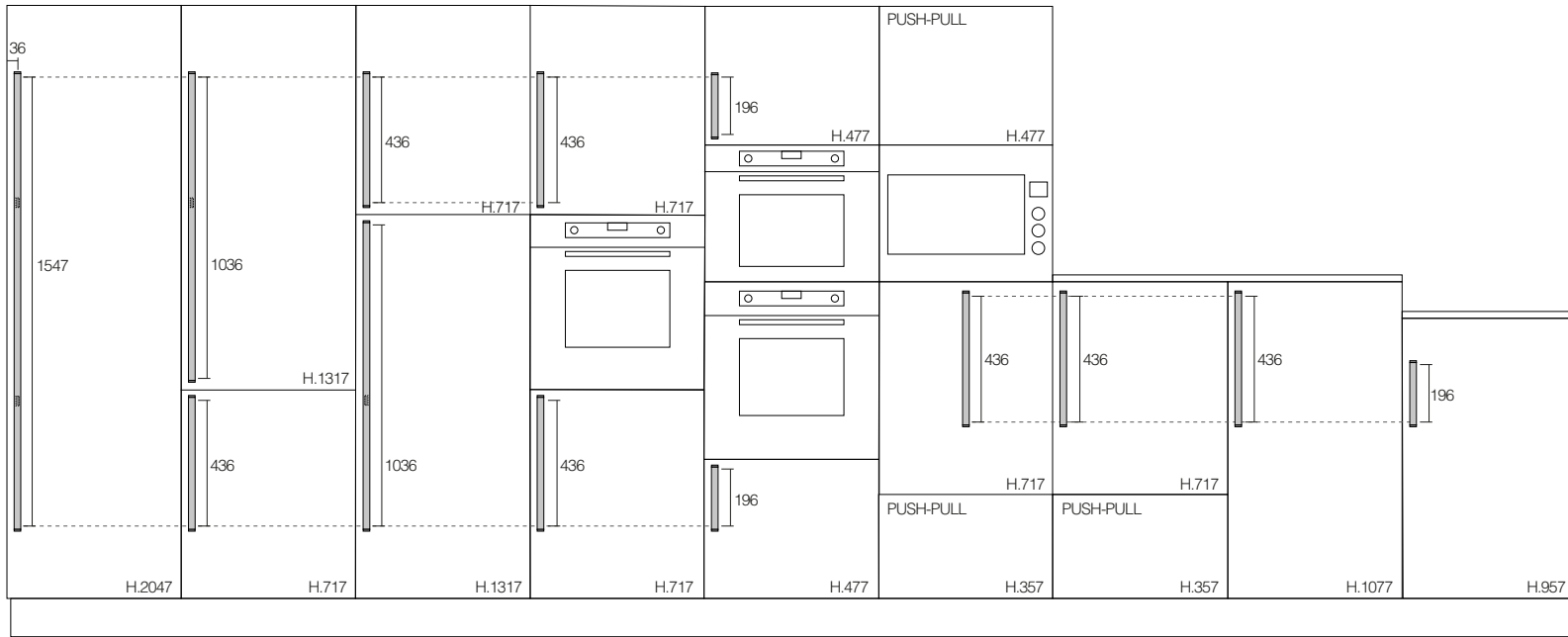

COLONNE ZOCCOLO H.13
H.13 PLINTH COLUMNS

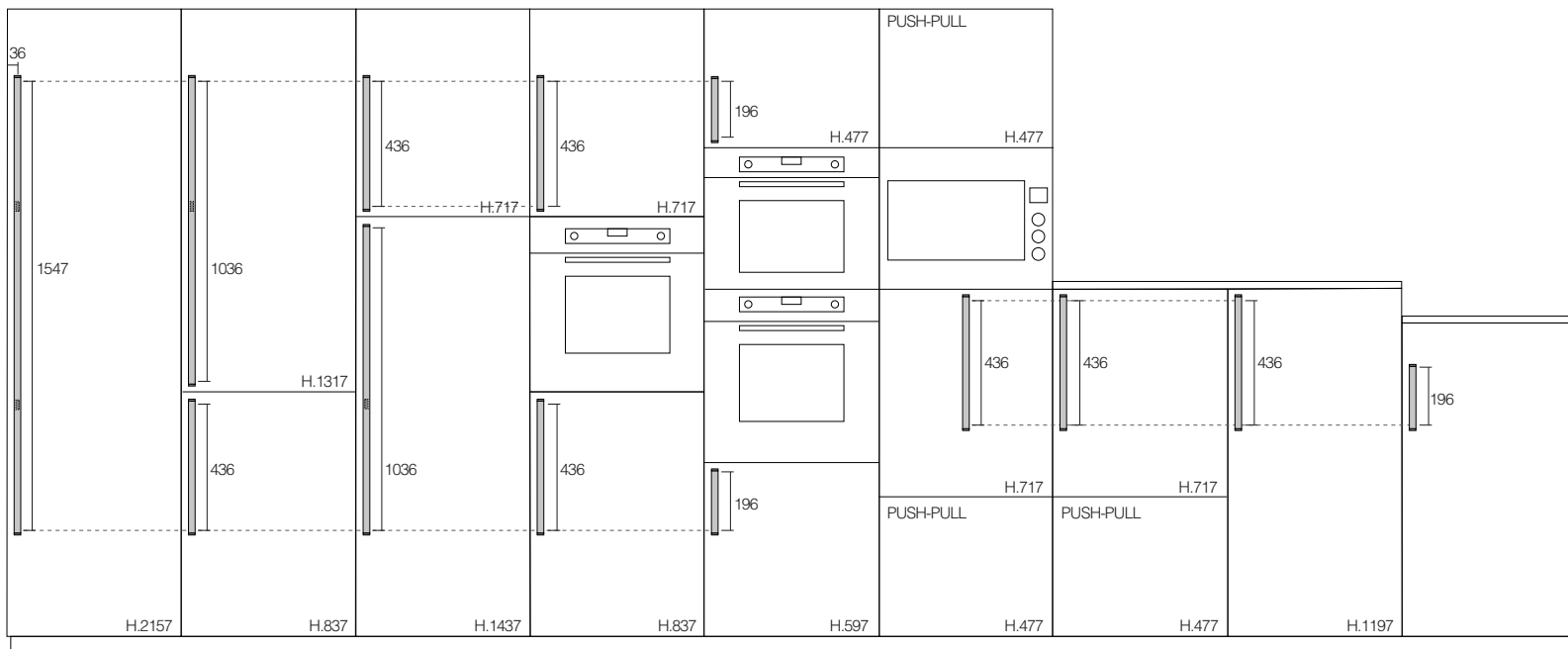

COLONNE ZOCCOLO H.6
H.6 PLINTH COLUMNS

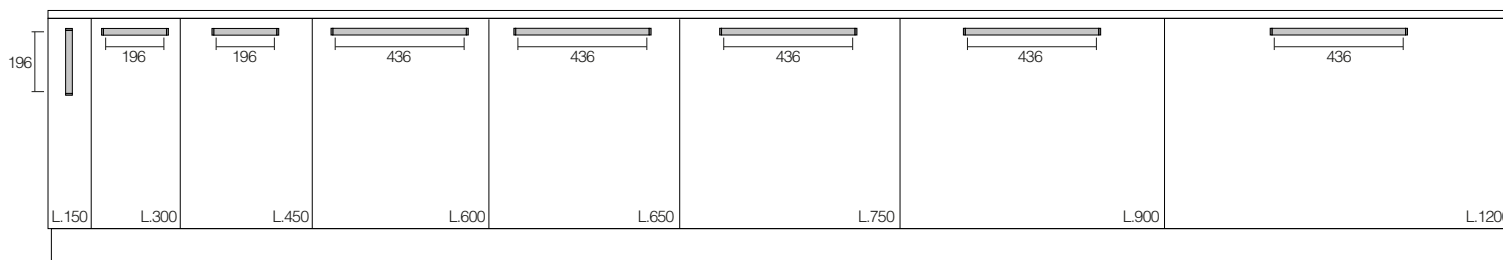

BASI ZOCCOLO H.6 e H.13
H.6 and H.13 BASE UNITS

 Maniglia non inseribile su basi con anta "Rain" e con anta "Rain Mix", disponibili solo Push-Pull e Tip-On.
Handle not available for base units with 'Rain' door and with 'Rain Mix' door, only available in Push-Pull and Tip-On versions.

 La maniglia verticale è disponibile anche per colonne con anta fino a terra, mantenendo lo stesso allineamento dall'alto riportato nei disegni tecnici.
The vertical handle is also available for columns with door down the ground while maintaining the same alignment from above shown in the technical drawings.

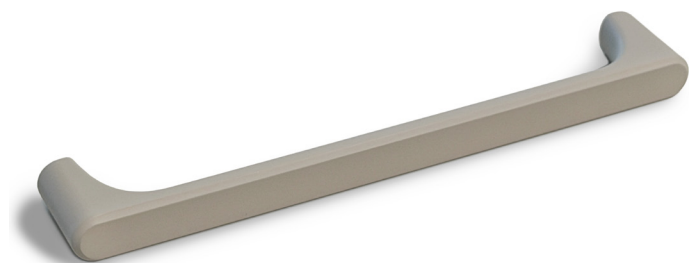

Maniglia 354
anta L 15 → passo 160 mm in verticale
anta da L 30 a L 45 → passo 160 mm
anta da L 60 a L 120 → passo 320 mm

Handle 354
door W 15 → centre-to-centre distance 160 mm vertical
door from W 30 to W 45 → centre-to-centre distance 160 mm
door from W 60 to W 120 → centre-to-centre distance 320 mm

FINITURE DISPONIBILI
AVAILABLE FINISHES

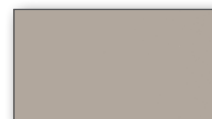

beige arizona
(opz.354BA)



in tinta con il decorativo
impiallacciato frassino
ARIZONA ASH

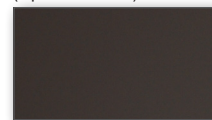

grigio aragona
(opz.354GA)



in tinta con il decorativo
impiallacciato frassino
ARAGONA ASH



verde kitami
(opz.354VK)

MANIGLIA HANDLE passo 160 mm
MANIGLIA HANDLE passo 320 mm



IMPIALLACCIATO ROVERE

OAK VENEERED

anta sp.23 mm costituita da un pannello in particelle di legno (conforme US EPA TSCA Title VI) impiallacciato.
23 mm thick door made of a veneered particle board panel (compliant with US EPA TSCA Title VI).

Neck cod. N40
Easy cod. L40
Bridge cod. B40

Rovere Moon
(opz.5450)



Rovere Nordico
(opz.5451)



Rovere Curry
(opz.5452)



Rovere Brandy
(opz.5455)



Rovere Torba
(opz.5454)



Rovere Tarmac
(opz.5453)

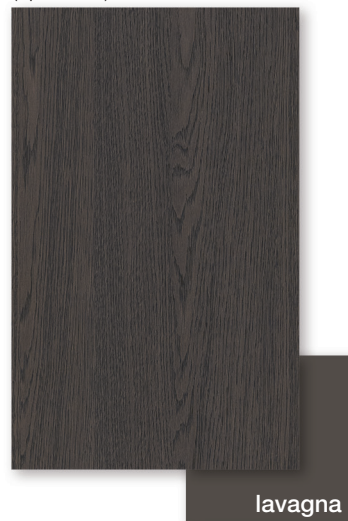

Noce Canaletto Intenso
(opz.1332)



Noce Canaletto Naturale
(opz.1333)



per i campioni colore fare riferimento al campionario IMPIALLACCIATI 1

For color samples, please refer to the VENEERED 1 sample book

IMPIALLACCIATO ROVERE "RAIN"

"RAIN" OAK VENEERED

anta sp.23 mm costituita da un pannello in MDF (conforme US EPA TSCA Title VI) impiallacciato e cannettato
23 mm thick door made of a veneered and reeded MDF panel (compliant with US EPA TSCA Title VI).

Neck cod. N40
Easy cod. L40
Bridge cod. B40

Rovere Moon Rain
(opz.5450R)



Rovere Nordico Rain
(opz.5451R)

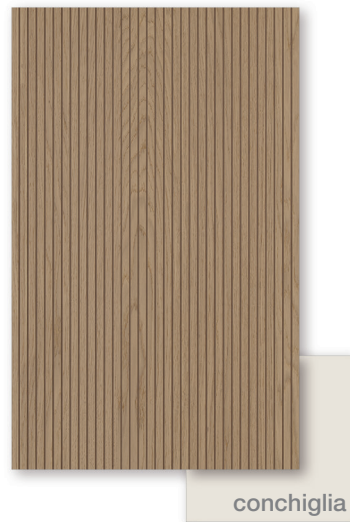

Rovere Curry Rain
(opz.5452R)



Rovere Brandy Rain
(opz.5455R)



Rovere Torba Rain
(opz.5454R)



Rovere Tarmac Rain
(opz.5453R)



per i campioni colore fare riferimento al campionario IMPIALLACCIATI 1

For color samples, please refer to the VENEERED 1 sample book

i DETTAGLIO TECNICO ANTA "RAIN" "RAIN" DOOR TECHNICAL DETAIL

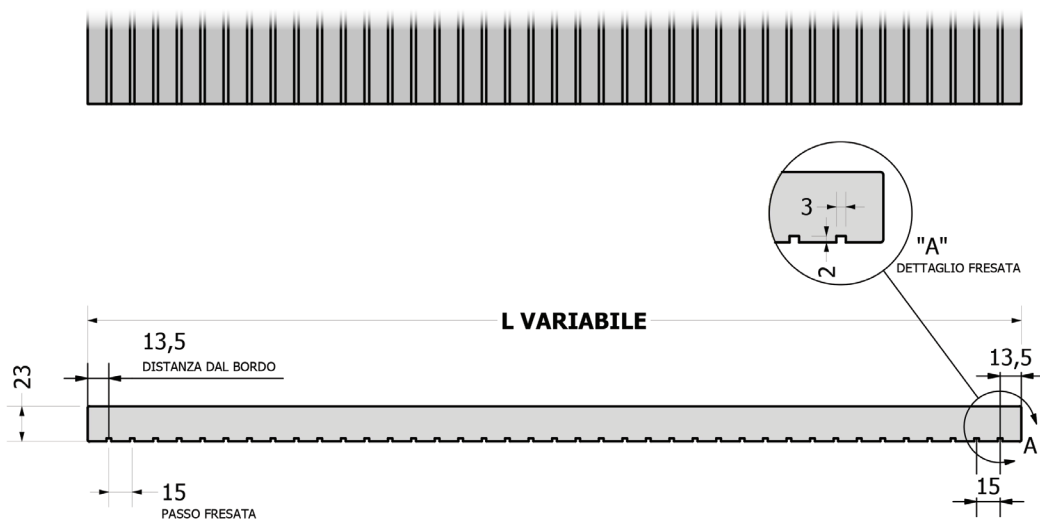

! La versione "RAIN" è disponibile NECK, EASY e in versione BRIDGE con solo una selezione di maniglie.
Anta "RAIN" non disponibile L 40 e 65
The "RAIN" version is available NECK, EASY and in BRIDGE version only with a selection of handles.
"RAIN" door not available in W 40 and 65

IMPIALLACCIATO ROVERE "RAIN MIX"

"RAIN MIX" OAK VENEERED

anta sp.23 mm costituita da un pannello in MDF (conforme US EPA TSCA Title VI) impiallacciato e cannettato
 23 mm thick door made of a veneered and reeded MDF panel (compliant with US EPA TSCA Title VI).

Neck cod. N40
 Easy cod. L40
 Bridge cod. B40

Rovere Moon Rain Mix
 (opz.5450M)



Rovere Nordico Rain Mix
 (opz.5451M)



Rovere Curry Rain Mix
 (opz.5452M)



Rovere Brandy Rain Mix
 (opz.5455M)



Rovere Torba Rain Mix
 (opz.5454M)



Rovere Tarmac Rain Mix
 (opz.5453M)



per i campioni colore fare riferimento al campionario IMPIALLACCIATI 1

For color samples, please refer to the VENEERED 1 sample book

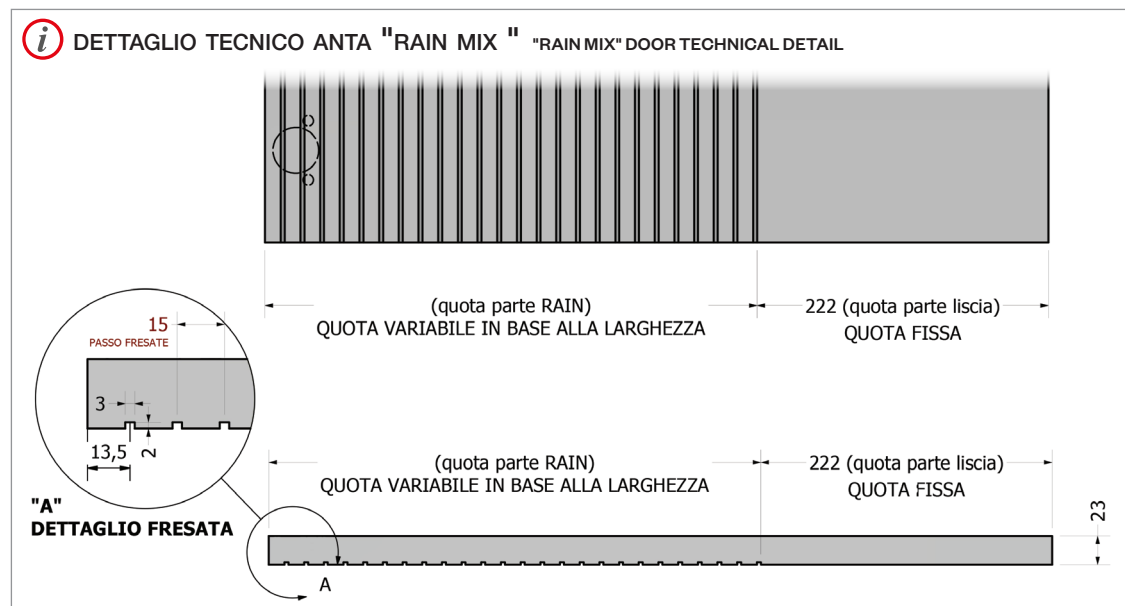

! La versione "RAIN MIX" è disponibile NECK, EASY e in versione BRIDGE con solo una selezione di maniglie.
Anta "RAIN MIX" disponibile solo per elementi con anta dx/sx L 45/60/75
 The "RAIN MIX" version is available NECK, EASY and in BRIDGE version only with a selection of handles.
"RAIN MIX" door available only for elements with right/left door W 45/60/75



IMPIALLACCIATO PAULOWNIA

PAULOWNIA VENEERED

anta sp.23 mm costituita da un pannello in particelle di legno (conforme US EPA TSCA Title VI) impiallacciato.
23 mm thick door made of a veneered particle board panel (compliant with US EPA TSCA Title VI).

Paulownia Toffee
(opz.085)



Paulownia Grigio Acai
(opz.086)



Paulownia Nero
(opz.087)

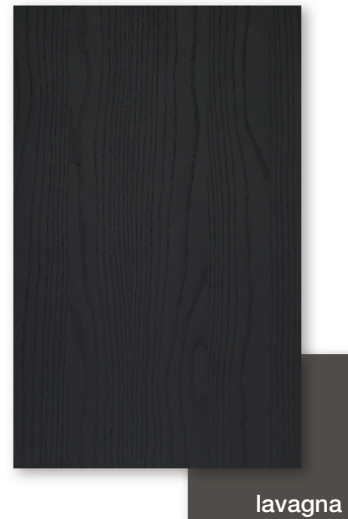

Neck cod. N40
Easy cod. L40
Bridge cod. B40



per i campioni colore fare riferimento al campionario IMPIALLACCIATI 1

For color samples, please refer to the VENEERED 1 sample book

IMPIALLACCIATO PAULOWNIA "RAIN"

"RAIN" PAULOWNIA VENEERED

anta sp.23 mm costituita da un pannello in MDF (conforme US EPA TSCA Title VI) impiallacciato e cannettato (RAIN o RAIN MIX) sul lato frontale.

23 mm thick door made of a MDF panel (compliant with US EPA TSCA Title VI) veneered and ribbed (RAIN or RAIN MIX) on the front side.

Paulownia Toffee Rain
(opz.085R)



Paulownia Grigio Acai Rain
(opz.086R)



Paulownia Nero Rain
(opz.087R)



Neck cod. N40
Easy cod. L40
Bridge cod. B40



per i campioni colore fare riferimento al campionario IMPIALLACCIATI 1

For color samples, please refer to the VENEERED 1 sample book

IMPIALLACCIATO PAULOWNIA "RAIN MIX"

"RAIN MIX" PAULOWNIA VENEERED

anta sp.23 mm costituita da un pannello in MDF (conforme US EPA TSCA Title VI) impiallacciato e cannettato (RAIN o RAIN MIX) sul lato frontale.

23 mm thick door made of a MDF panel (compliant with US EPA TSCA Title VI) veneered and ribbed (RAIN or RAIN MIX) on the front side.

Neck cod. N40
Easy cod. L40
Bridge cod. B40

Paulownia Toffee Rain Mix
(opz.085M)



visone

Paulownia Grigio Acai
Rain Mix (opz.086M)



lavagna

Paulownia Nero Rain Mix
(opz.087M)



lavagna



per i campioni colore fare riferimento al campionario IMPIALLACCIATI 1

For color samples, please refer to the VENEERED 1 sample book



La versione "RAIN MIX" è disponibile NECK, EASY e in versione BRIDGE con solo una selezione di maniglie.

Anta "RAIN MIX" disponibile solo per elementi con anta dx/sx L 45/60/75

The "RAIN MIX" version is available NECK, EASY and in BRIDGE version only with a selection of handles.

"RAIN MIX" door available only for elements with right/left door W 45/60/75

IMPIALLACCIATO EUCALIPTO

EUCALIPTO VENEERED

anta sp.23 mm costituita da un pannello in particelle di legno (conforme US EPA TSCA Title VI) impiallacciato.
23 mm thick door made of a veneered particle board panel (compliant with US EPA TSCA Title VI).

Eucalipto Affumicato
(opz.4851)



i I frontali impiallacciati nella finitura Eucalipto vengono numerati in produzione con una sequenza di montaggio per garantire continuità di fiamma nella composizione.
Veneered doors in Eucalipto finish are numbered in production with an assembly sequence to ensure wood grain continuity in the composition.

Neck cod. N40
Easy cod. L40
Bridge cod. B40



per i campioni colore fare riferimento al campionario IMPIALLACCIATI 1

For color samples, please refer to the VENEERED 1 sample book

IMPIALLACCIATO EUCALIPTO "RAIN"

"RAIN" EUCALIPTO VENEERED

anta sp.23 mm costituita da un pannello in MDF (conforme US EPA TSCA Title VI) impiallacciato e cannettato (RAIN o RAIN MIX) sul lato frontale.

23 mm thick door made of a MDF panel (compliant with US EPA TSCA Title VI) veneered and ribbed (RAIN or RAIN MIX) on the front side.

Eucalipto Affumicato Rain
(opz.4851R)



Neck cod. N40
Easy cod. L40
Bridge cod. B40



per i campioni colore fare riferimento al campionario IMPIALLACCIATI 1

For color samples, please refer to the VENEERED 1 sample book

IMPIALLACCIATO EUCALIPTO "RAIN MIX"

"RAIN MIX" EUCALIPTO VENEERED

anta sp.23 mm costituita da un pannello in MDF (conforme US EPA TSCA Title VI) impiallacciato e cannettato (RAIN o RAIN MIX) sul lato frontale.

23 mm thick door made of a MDF panel (compliant with US EPA TSCA Title VI) veneered and ribbed (RAIN or RAIN MIX) on the front side.

Eucalipto Affumicato
Rain Mix (opz.4851M)

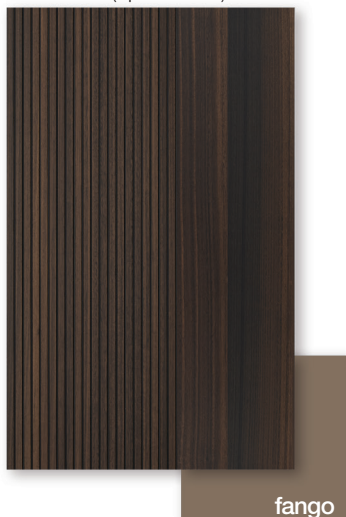

Neck cod. N40
Easy cod. L40
Bridge cod. B40



per i campioni colore fare riferimento al campionario IMPIALLACCIATI 1

For color samples, please refer to the VENEERED 1 sample book



La versione "RAIN" è disponibile NECK, EASY e in versione BRIDGE con solo una selezione di maniglie.

Anta "RAIN" non disponibile L 40 e 65

The "RAIN" version is available NECK, EASY and in BRIDGE version only with a selection of handles.

"RAIN" door not available in W 40 and 65

IMPIALLACCIATO VINTAGE

VINTAGE VENEERED

anta sp.23 mm costituita da un pannello in particelle di legno (conforme US EPA TSCA Title VI) impiallacciato.
23 mm thick door made of a veneered particle board panel (compliant with US EPA TSCA Title VI).

Rovere Mielato Invecchiato
(opz.5383)



fango

Rovere Madera Termocotto
(opz.5388)



fango

 I frontali impiallacciati vintage non sono disponibili nelle versioni RAIN, RAIN MIX.
Vintage veneered doors are not available in RAIN, RAIN MIX versions.

Neck cod. N40
Easy cod. L40
Bridge cod. B40



per i campioni colore fare riferimento al campionario IMPIALLACCIATI 1

For color samples, please refer to the VENEERED 1 sample book



IMPIALLACCIATO FRASSINO VERNICIATO A ECCIMERI

ASH VENEERED PAINTED WITH EXCIMER

anta sp.22 mm costituita da un pannello di particelle di legno (conforme US EPA TSCA Title VI) impiallacciato frassino laccato a poro aperto, verniciato UV a eccimeri lato frontale, fiamma verticale, con bordo polipropilene (PP) 1mm.

22 mm thick door made of a particle board panel (US EPA TSCA Title VI compliant) with open pore lacquered ash veneer, excimer UV varnished on the front side, vertical flame, with 1mm polypropylene (PP) edge.

Neck cod. G43

Lux cod. G48

Bridge cod. 296

Head cod. 297



per i campioni colore fare riferimento al campionario IMPIALLACCIATI 2

For color samples, please refer to the VENEERED 2 sample book

Arizona ash
(opz.2437)



visone

Aragona ash
(opz.2438)



lavagna

Rafia ash
(opz.2436)



conchiglia

IMPIALLACCIATO ROVERE VERNICIATO A ECCIMERI

OAK VENEERED PAINTED WITH EXCIMER

anta sp.22 mm costituita da un pannello di particelle di legno (conforme US EPA TSCA Title VI) impiallacciato rovere tinto, verniciato UV a eccimeri lato frontale, fiamma verticale, con bordo polipropilene (PP) 1mm.

22 mm thick door made of a particle board panel (US EPA TSCA Title VI compliant) with stained oak, excimer UV varnished on the front side, vertical flame, with 1mm polypropylene (PP) edge.

Neck cod. G43
Lux cod. G48
Bridge cod. 296
Head cod. 297



per i campioni colore fare riferimento al campionario IMPIALLACCIATI 2

For color samples, please refer to the VENEER 2 sample book

Namib oak
(opz.5447)



conchiglia

Moscato oak
(opz.5448)



fango

Fumè oak
(opz.5449)



lavagna