



2022

unica

# Unica



**Unica è una cucina moderna, pratica e funzionale. Un modello versatile in grado di interpretare stili contemporanei diversi grazie alla ampia gamma di finiture disponibili.**

UNICA is a modern, practical and functional kitchen. A versatile model, capable of interpreting different contemporaries styles thanks to the wide range of available finishes.

## Anta quadrata con maniglia a gola

Square door with finger rail opening

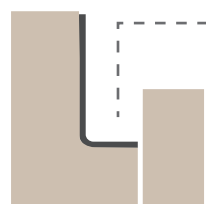

- gola tipo "elle"  
"L" type finger rail

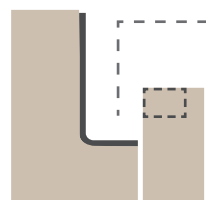

- gola tipo "elle" con maniglia incassata  
"L" type finger rail with recessed handle





## Anta con profilo per apertura con gola a “elle”

Door with profile for opening with “L” finger rail

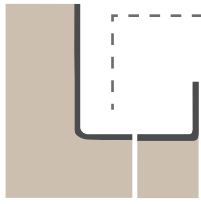

gola tipo “elle”  
“L” type finger rail





## Anta con maniglia

Door with handle

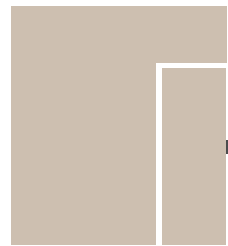

FRONTALE  
anta con  
maniglia  
frontale  
door with front  
handle

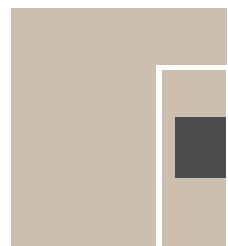

FRONTALE  
anta con  
maniglia  
incassata  
door with  
recessed handle



# Head

---

**Anta con maniglia applicata in testa**  
door with top-mounted handle





SP. 22 MM

## CARATTERISTICHE TECNICHE

### ANTE E FRONTALI CASSETTI

anta sp.22 mm costituita da un supporto di pannello di particelle di legno (conforme **US EPA TSCA Title VI**) stondate nei lati verticali raggio 7 mm e bordate polipropilene sp.10/10 in tinta nei lati orizzontali disponibili nei colori opachi:

**phagos finitura chiselled venatura verticale:** nuvola (opz.1567), kapok (opz.1560), vulcano (opz.1568), bianco (opz.1566)

**finitura rovere naturale venatura verticale:** perla (opz.5314)

**finitura materica effetto pietra:** pietra fulvus (opz.8867), pietra grey (opz.9642), pietra musk (opz.8403)

**finitura effetto ossidato:** platino (opz.9661)

**finitura seta tinta unita:** bianco assoluto (opz.7450), dove grey (opz.8971), ecru (opz.9641), grigio chiaro (opz.9640), antracite (opz.9643)

### ANTE VETRO

telaio alluminio verniciato grigio selce sp.22 mm con vetro:  
trasparente (opz.UNGT), satinato (opz.UNGS), bronzo satinato (opz.UNGB)

telaio alluminio verniciato silver dark sp.22 mm con vetro:  
trasparente (opz.UNST), satinato (opz.UNSS), fumè satinato (opz.UNSF)

telaio alluminio verniciato nero sp.22 mm con vetro:  
trasparente (opz.UNNT), satinato (opz.UNNS), fumè satinato (opz.UNNF)

### PROFILI E GOLE

**N.B.:** per le finiture profili e gole vedi pag.18-19

### MANIGLIE

vedi pag.24-28

### STRUTTURE

**ANTE: phagos bianco, bianco assoluto**

nobilitato bianco (opz.001), schiena e ripiano bianco (opz.001)

**ANTE: rovere perla, pietra grey, pietra musk, antracite, grigio chiaro**

nobilitato argilla (opz.9690) schiena e ripiano argilla (opz.9690)

**ANTE: pietra fulvus, dove grey, ecru, ossidato platino, phagos nuvola, phagos vulcano, phagos kapok**

nobilitato visone (opz.948M) schiena e ripiano visone (opz.948M)

a richiesta: nobilitato conchiglia (opz.8910) schiena e ripiano conchiglia (opz.8910)

nobilitato lavagna (opz.9620) schiena e ripiano lavagna (opz.9620)

nobilitato fango (opz.8860) schiena e ripiano fango (opz.8860)

nobilitato lino effetto tela (opz.8920) schiena e ripiano conchiglia (opz.8910)



\*per componenti si intendono tutte le strutture, alcune ante e alcuni complementi del modello.



GREENGUARD  
LE STRUTTURE DELLE CUCINE SONO CONTRADDISTINTE DALLA CERTIFICAZIONE GREENGUARD GOLD, PER SODDISFARE GLI STANDARD PIU' RIGOROSI IN TERMINI DI LIVELLI DI EMISSIONE DI COMPOSTI ORGANICI VOLATILI (COV).

### MENSOLE

**di serie:** altezza 3,8 cm in laminato, bianco (opz.001), argilla (opz.9690), visone (opz.948M), conchiglia (opz.8910), lavagna (opz.9620), fango (opz.8860)

**a richiesta:** altezza 3,8 cm finiture come ante

### ZOCCOLI

vedi pag.31





# Melamine

TH. 22 MM

---

Neck	cod.	N35
Neck with handle	cod.	N36
Lux	cod.	L35
Bridge	cod.	B35
Head	cod.	B36

## TECHNICAL FEATURES

---

### DOORS AND DRAWERS FRONT

22 mm thick door consisting of a support of wood particle board (compliant with [US EPA TSCA Title VI](#)) rounded on the vertical sides with a radius of 7 mm and edged in polypropylene thickness 10/10 in the same color on the horizontal sides available in lacquered colors:

**phagos chiselled finish vertical grain:** cloud (opt.1567), kapok (opt.1560), volcano (opt.1568), white (opt.1566)

**vertical grain natural oak finish:** pearl (opt.5314)

**material finish with stone effect:** stone fulvus (opt.8867), stone grey (opt.9642), stone musk (opt.8403)

**oxidized effect finish:** platinum (opt.9661)

**solid color silk finish:** absolute white (opt.7450), grey dove (opt.8971), ecru (opt.9641), clear grey (opt.9640), anthracite (opt.9643)

---

### GLASS DOORS

22 mm thick flint grey-coated aluminum frame with glass:  
transparent (opt.UNGT), satin (opt.UNGS), satin bronze (opt.UNGB)

22 mm thick dark silver-coated aluminum frame with glass:  
transparent (opt.UNST), satin (opt.UNSS), smoked satin (opt.UNSF)

22 mm thick black-coated aluminum frame with glass:  
transparent (opt.UNNT), satin (opt.UNNS), smoked satin (opt.UNNF)

---

### PROFILES AND FINGER RAILS

**Note: for the profiles and finger rails finishes see page 18-19**

---

### HANDLES

**see on page 24-28**

---

### STRUCTURES

**DOORS: phagos white, absolute white**

melamine-coated white (opt.001), white back panel and shelf (opt.001)

**DOORS: oak pearl, stone grey, stone musk, anthracite, clear grey**

melamine-coated clay (opt.9690), clay back panel and shelf (opt.9690)

**DOORS: stone fulvus, grey dove, ecru, oxidized platinum, phagos cloud, phagos volcano, phagos kapok**

melamine-coated mink (opt.948M), mink back panel and shelf (opt.948M)

**on request:**

melamine-coated shell (opt.8910), shell back panel and shelf (opt.8910)

melamine-coated slate grey (opt.9620), slate grey back panel and shelf (opt.9620)

melamine-coated mud (opt.8860), mud back panel and shelf (opt.8860)

linen melamine-coated canvas effect (opt.8920), shell back panel and shelf (opt.8910)

---

### SHELVES

**standard:** height 3.8 cm, made of laminate, white (opt.001), clay (opt.9690), mink (opt.948M), shell (opt.8910), slate grey (opt.9620), mud (opt.8860)

**on request:** height 3.8 cm, finishes as doors

---

### PLINTHS

**see on page 31**

---

# Melaminico fascia "A"

# Melamine band "A"

SP. 22 MM TH. 22 MM

 *colori in pronta consegna  
available colours*

<b>N</b> eck	cod.	<b>N35</b>
<b>N</b> eck con maniglia with handle	cod.	<b>N36</b>
<b>L</b> ux	cod.	<b>L35</b>
<b>B</b> ridge	cod.	<b>B35</b>
<b>H</b> ead	cod.	<b>B36</b>

ante phagos finitura chiselled  
chiselled finish phagos doors



nuvola (opz.1567)  
cloud

bianco (opz.1566)  
white

anta finitura rovere naturale  
natural oak finish door



perla (opz.5314)  
pearl

anta finitura effetto ossidato  
oxidized effect finish door



platino (opz.9661)  
platinum

anta finitura materica  
textured finish door



pietra grey (opz.9642)  
stone grey

ante finitura seta tinta unita  
solid color silk finish doors

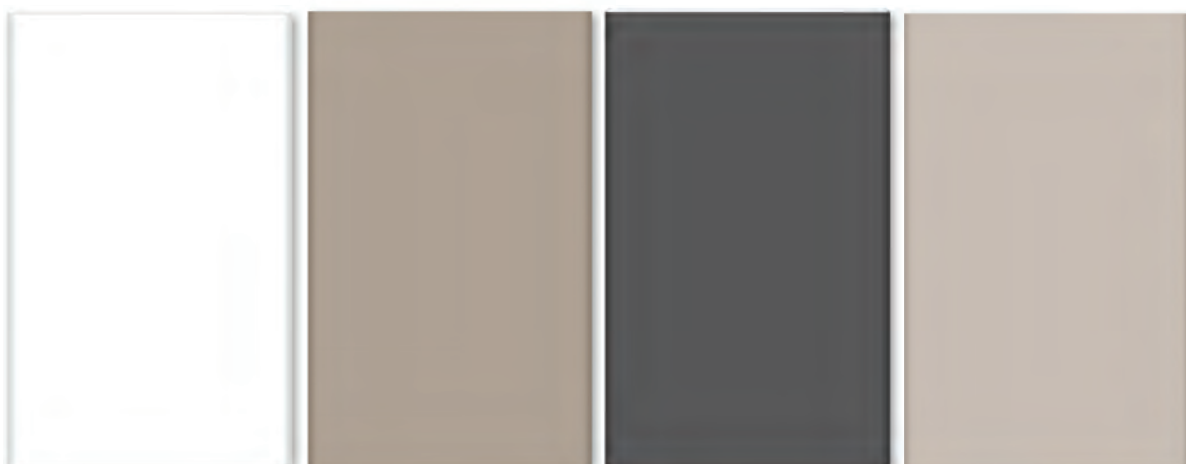

bianco assoluto (opz.7450)  
absolute white

ecru (opz.9641)  
ecru

antracite (opz.9643)  
anthracite

dove grey (opz.8971)  
grey dove

# Melaminico fascia "B"

# Melamine band "B"

SP. 22 MM TH. 22 MM

ante phagos finitura chiselled  
chiselled finish phagos doors



kapok (opz.1560)  
kapok

vulcano (opz.1568)  
volcano

anta finitura materica  
textured finish door



pietra fulvus (opz.8867)  
stone fulvus

pietra musk (opz.8403)  
stone musk

ante finitura seta tinta unita  
solid color silk finish doors



grigio chiaro (opz.9640)  
clear grey

Neck	cod.	N35
Neck con maniglia with handle	cod.	N36
Lux	cod.	L35
Bridge	cod.	B35
Head	cod.	B36

SP. 22 MM TH.22 MM

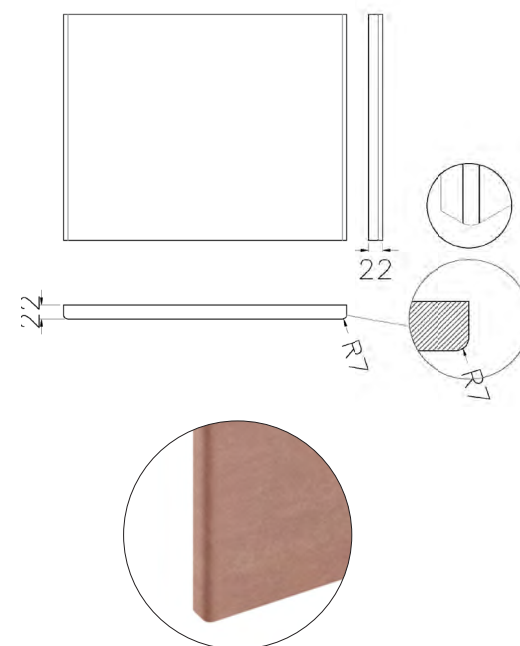

particolare anta  
detail of door



## Telaio alluminio

Aluminium frame

telaio alluminio verniciato grigio selce sp.22 mm vetro trasparente, satinato, bronzo satinato

22 mm-thick flint grey-coated aluminium frame with transparent, satin, satin bronze glass



telaio grigio selce con vetro trasparente (opz.UNGT)  
flint grey frame with transparent glass (opt.UNGT)



telaio grigio selce con vetro satinato (opz.UNGS)  
flint grey frame with satin glass (opt.UNGS)



telaio grigio selce con vetro bronzo satinato (opz.UNGB)  
flint grey frame with satin bronze glass (opt.UNGB)



particolare anta vetro  
detail glass door

telaio alluminio verniciato silver dark sp.22 mm vetro trasparente, satinato, fumè satinato

22 mm-thick dark silver-coated aluminium frame with transparent, satin, smoked satin glass



telaio silver dark con vetro trasparente (opz.UNST)  
dark silver frame with transparent glass (opt.UNST)



telaio silver dark con vetro satinato (opz.UNSS)  
dark silver frame with satin glass (opt.UNSS)



telaio silver dark con vetro fumè satinato (opz.UNSF)  
dark silver frame with smoked satin glass (opt.UNSF)



particolare anta vetro  
detail glass door

## Telaio alluminio

Aluminium frame

telaio alluminio verniciato nero sp.22 mm vetro trasparente, satinato, fumè satinato

22 mm-thick black-coated aluminium frame with transparent, satin, smoked satin glass



telaio nero con vetro  
trasparente (opz.UNNT)  
black frame with transparent  
glass (opt.UNNT)



telaio nero con vetro  
satinato (opz.UNNS)  
black frame with satin glass  
(opt.UNNS)



telaio nero con vetro  
fumè satinato (opz.UNNF)  
black frame with smoked  
satin glass (opt.UNNF)



particolare anta vetro  
detail glass door

## Telaio alluminio con maniglia

Aluminum frame with handle

telaio alluminio verniciato grigio selce sp.22 mm vetro trasparente, satinato, bronzo satinato

22 mm-thick flint grey-coated aluminium frame with transparent, satin, satin bronze glass



telaio grigio selce con vetro trasparente (opz.UNGT)  
flint grey frame with transparent glass (opt.UNGT)



telaio grigio selce con vetro satinato (opz.UNGS)  
flint grey frame with satin glass (opt.UNGS)



telaio grigio selce con vetro bronzo satinato (opz.UNGB)  
flint grey frame with satin bronze glass (opt.UNGB)



particolare anta vetro  
detail glass door

telaio alluminio verniciato silver dark sp.22 mm vetro trasparente, satinato, fumè satinato

22 mm-thick dark silver-coated aluminium frame with transparent, satin, smoked satin glass



telaio silver dark con vetro trasparente (opz.UNST)  
dark silver frame with transparent glass (opt.UNST)



telaio silver dark con vetro satinato (opz.UNSS)  
dark silver frame with satin glass (opt.UNSS)



telaio silver dark con vetro fumè satinato (opz.UNSF)  
dark silver frame with smoked satin glass (opt.UNSF)



particolare anta vetro  
detail glass door



## Telaio alluminio con maniglia

Aluminum frame with handle

telaio alluminio verniciato nero sp.22 mm vetro trasparente, satinato, fumè satinato

22 mm-thick black-coated aluminium frame with transparent, satin, smoked satin glass



telaio nero con vetro  
trasparente (opz.UNNT)  
black frame with transparent  
glass (opt.UNNT)



telaio nero con vetro  
satinato (opz.UNNS)  
black frame with satin glass  
(opt.UNNS)



telaio nero con vetro  
fumè satinato (opz.UNNF)  
black frame with smoked  
satin glass (opt.UNNF)



particolare anta vetro  
detail glass door



Esempio di anta unica a vetro per colonna con maniglia centrale  
Example of single glass door for column with central handle

# Finiture gole / Finger rails finishes

## Neck

---

**Finiture gole  
spazzolate**  
Finger rails  
brushed finishes



titanio ossidato (opz.414)  
titanium oxidized  
(opt.414)



brill (opz.412)  
brill (opt.412)

**Finiture gole  
verniciate a polvere  
opache**  
Matt finger rails  
powder coated finishes

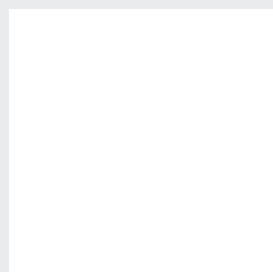

bianco assoluto  
(opz.740S)  
absolute white  
(opt.740S)

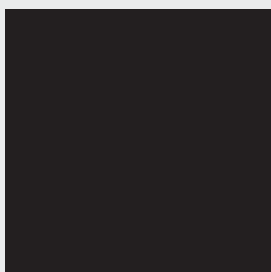

nero (opz.7892)  
black (opt.7892)

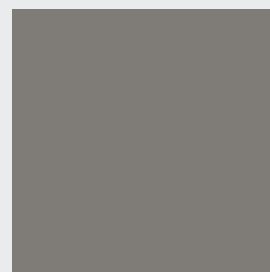

fumo (opz.9531)  
smoke (opt.9531)

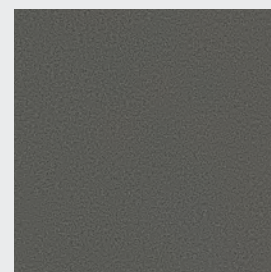

silver dark (opz.9507)  
dark silver (opt.9507)

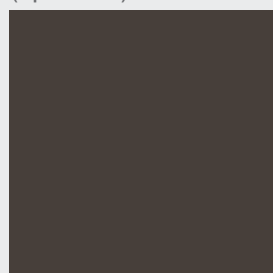

ghisa (opz.9509)  
cast iron (opt.9509)

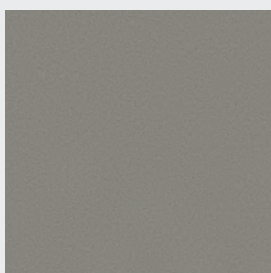

grigio selce (opz.SEL)  
flint grey (opt.SEL)

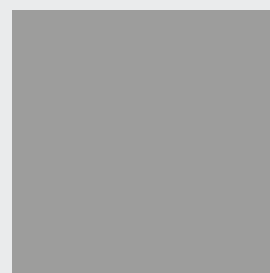

grigio traffico (opz.9511)  
traffic grey (opt.9511)

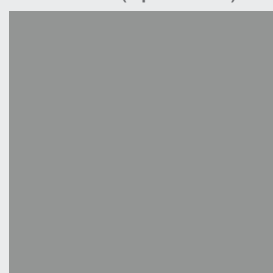

argilla (opz.9503)  
clay (opt.9503)

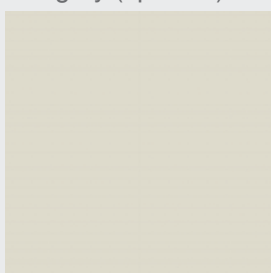

lino (opz.W770)  
linen (opt.W770)

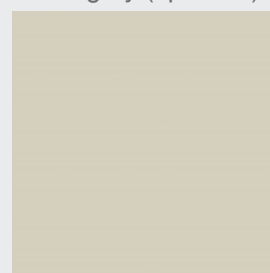

conchiglia (opz.7403)  
seashell (opt.7403)

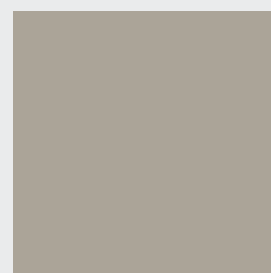

grigio kenya (opz.9501)  
kenya grey (opt.9501)

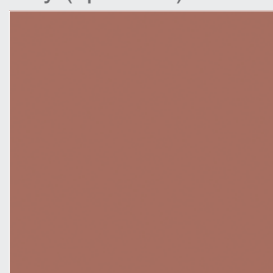

rosso persia (opz.8165)  
persia red (opt.8165)

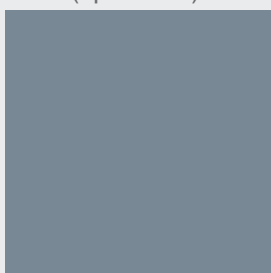

azzurro nube (opz.8379)  
cloud blue (opt.8379)

# Finiture gole / Finger rails finishes

## LUX

---

**Finiture gole  
spazzolate**  
Finger rails  
brushed finishes



titanio ossidato (opz.414)  
titanium oxidized  
(opt.414)

**Finiture gole  
verniciate a polvere  
opache**  
Matt finger rails  
powder coated finishes



rosso persia (opz.8165)  
persia red (opt.8165)

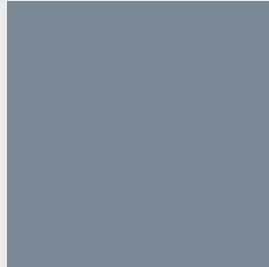

azzurro nube (opz.8379)  
cloud blue (opt.8379)



nero (opz.7892)  
black (opt.7892)

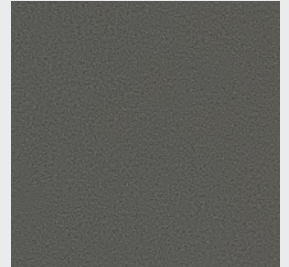







silver dark (opz.9507)  
dark silver (opt.9507)



# GOLA "ELLE" ORIZZONTALE SOTTOTOP

UNDERMOUNT HORIZONTAL "ELLE" FINGER RAIL



	COD.			COD.	
<p><b>Gola sottotop tipo "A"</b> Type "A" undermount finger rail</p> 				<p><b>Angolo interno a 90° per gola tipo "A"</b> 90° interior corner for "A" type finger rail</p> 	
	al ml per lm	G950010		cadauno each	G950050
<p><b>Terminale aperto dx o sx per gola tipo "A" da utilizzare a fine composizione</b> RH or LH open end for type "A" finger rail to be placed at the end of the composition</p> 				<p><b>Angolare con snodo per unione fuori squadra per gola tipo "A"</b> Corner piece with joint for out-of-plumb joining for type "A" finger rail</p> 	
	<b>terminale DX</b> RH end	G950021			
	<b>terminale SX</b> LH end	G950022			
<p><b>Terminale chiuso dx o sx per gola tipo "A" da utilizzare solo tra basi e colonne</b> RH or LH closure for type "A" finger rail to be placed only between base units and column</p> 					
	<b>terminale DX</b> RH end	G950031			
	<b>terminale SX</b> LH end	G950032			
					G950060
<p><b>Coppia angolari per kit raccordo base angolo 110x110</b> <b>N:B: obbligatori</b> Couple corner piece for fitting kit corner base unit 110x110 <b>Note: obligatory</b></p> 					
	SX LH				
	DX RH				
	<b>in alluminio</b> aluminium				
	<b>angolare DX</b> RH corner piece	G950058			
	<b>angolare SX</b> LH corner piece	G950059			





# GOLA "ELLE" ORIZZONTALE INTERMEDIA

INTERMEDIATE HORIZONTAL "ELLE" FINGER RAIL

# GOLE "ELLE" VERTICALI PER COLONNE

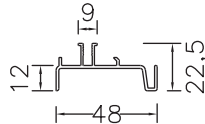
VERTICAL "ELLE" FINGER RAILS FOR COLUMNS

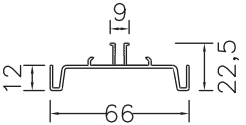
	COD.	
<p><b>Gola intermedia tipo "B"</b> Type "B" intermediate finger rail</p>  <p style="text-align: right;"><b>al ml</b> per lm</p>	G950110	
<p><b>Terminale aperto dx o sx per gola tipo "B" da utilizzare a fine composizione</b> RH or LH open end for type "B" finger rail to be placed at the end of the composition</p>  <p style="text-align: right;"><b>terminale DX</b> RH end</p> <p style="text-align: right;"><b>terminale SX</b> LH end</p>	G950121 G950122	
<p><b>Terminale chiuso dx o sx per gola tipo "B" da utilizzare solo tra cassettiere e lavastoviglie/colonne</b> RH or LH closure for type "B" finger rail to be placed only between drawer units and dishwasher/columns</p>  <p style="text-align: right;"><b>terminale DX</b> RH end</p> <p style="text-align: right;"><b>terminale SX</b> LH end</p>	G950131 G950132	

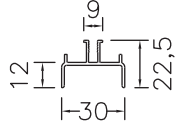
	COD.	
<p><b>Mezza gola verticale tipo "C" (completa di distanziale)</b> Type "C" half vertical finger rail (complete with spacer)</p>   <p style="text-align: center;"><b>sezione mezza gola tipo "C"</b> cross section of type "C" finger rail</p> <p><b>Piedi H 13</b> H 96 H 132 H 204 H 228</p> <p><b>Piedi H 6</b> H 108 H 144 H 216</p>	G950310 G950330 G950350 G950370 G950320 G950340 G950360	
<p><b>Gola verticale intermedia tipo "D" (completa di distanziale)</b> Type "D" intermediate vertical finger rail (complete with spacer)</p>   <p style="text-align: center;"><b>sezione gola tipo "D"</b> cross section of type "D" finger rail</p> <p><b>Piedi H 13</b> H 96 H 132 H 204 H 228</p> <p><b>Piedi H 6</b> H 108 H 144 H 216</p>	G950410 G950430 G950450 G950470 G950420 G950440 G950460	
<p><b>Gola verticale laterale tipo "E" (completa di distanziale)</b> Type "E" lateral vertical finger rail (complete with spacer)</p>   <p style="text-align: center;"><b>sezione gola tipo "E"</b> cross section of type "E" finger rail</p> <p><b>Piedi H 13</b> H 96 H 132 H 204 H 228</p> <p><b>Piedi H 6</b> H 108 H 144 H 216</p>	G950510 G950530 G950550 G950570 G950520 G950540 G950560	

# NOZIONI UTILI - gole "elle" orizzontali per basi

USEFUL INFORMATION - HORIZONTAL "ELLE" FINGER RAILS FOR BASE UNITS

## VISTA FRONTALE ZOCCOLO H 13 PER BASI H 88

FRONT VIEW PLINTH H 13 FOR BASE UNITS H 88

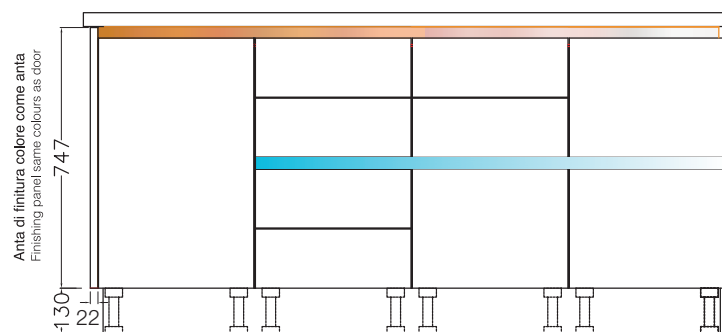
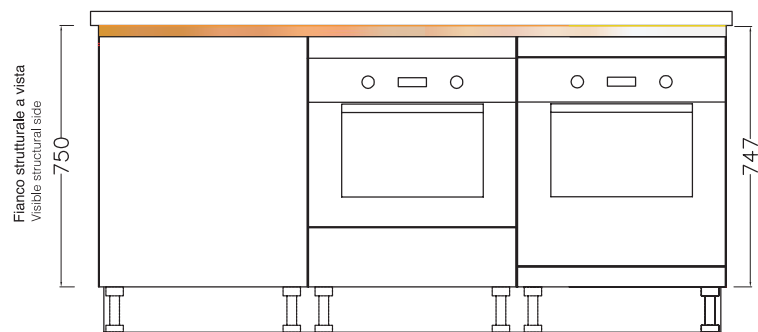

## VISTA LATERALE (sezione) ZOCCOLO H 13 PER BASI H 88

SIDE VIEW (CROSS SECTION) PLINTH H 13 FOR BASE UNITS H 88

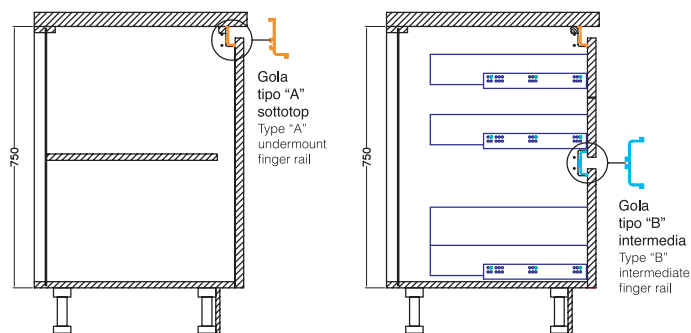

## VISTA DALL'ALTO

TOP VIEW

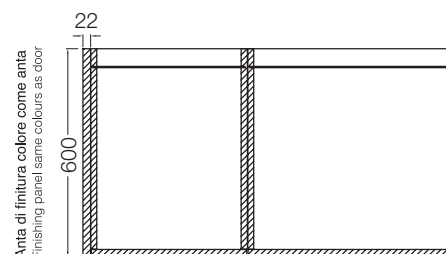
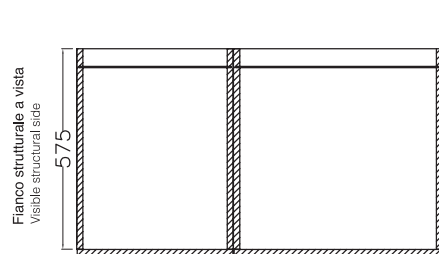

Composizione con ante di finitura laterali: alla dimensione finale della cucina, sommare sempre lo spessore delle ante di finitura (ogni anta 2,2 cm)

Composition with side finishing panels: to the final size of the kitchen, always add the thickness of the finishing panels (each panel 22 mm)

# NOZIONI UTILI - gole "elle" verticali per colonne

USEFUL INFORMATION - VERTICAL "ELLE" FINGER RAILS FOR COLUMNS

## VISTA FRONTALE ZOCCOLO H 13

FRONT VIEW PLINTH H 13

N.B.: PER LA VERSIONE LUX SULLE COLONNE IL PROFILO ANTA E' SEMPRE VERTICALE  
NOTE: DOOR PROFILE ON THE COLUMNS FOR LUX VERSION IS ALWAYS VERTICAL

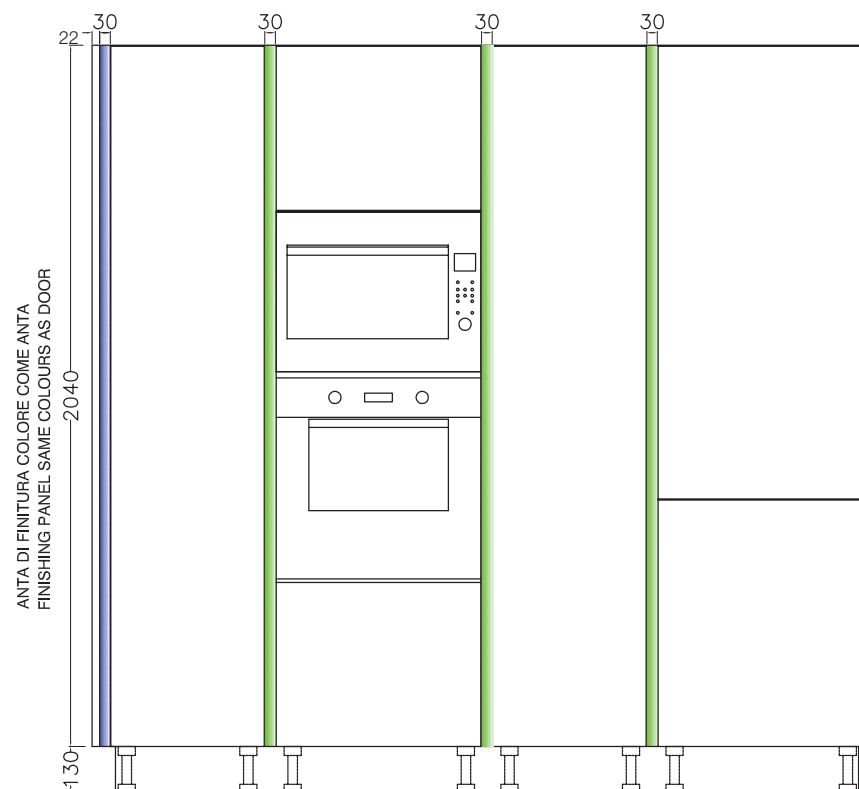

## VISTA DALL'ALTO

TOP VIEW

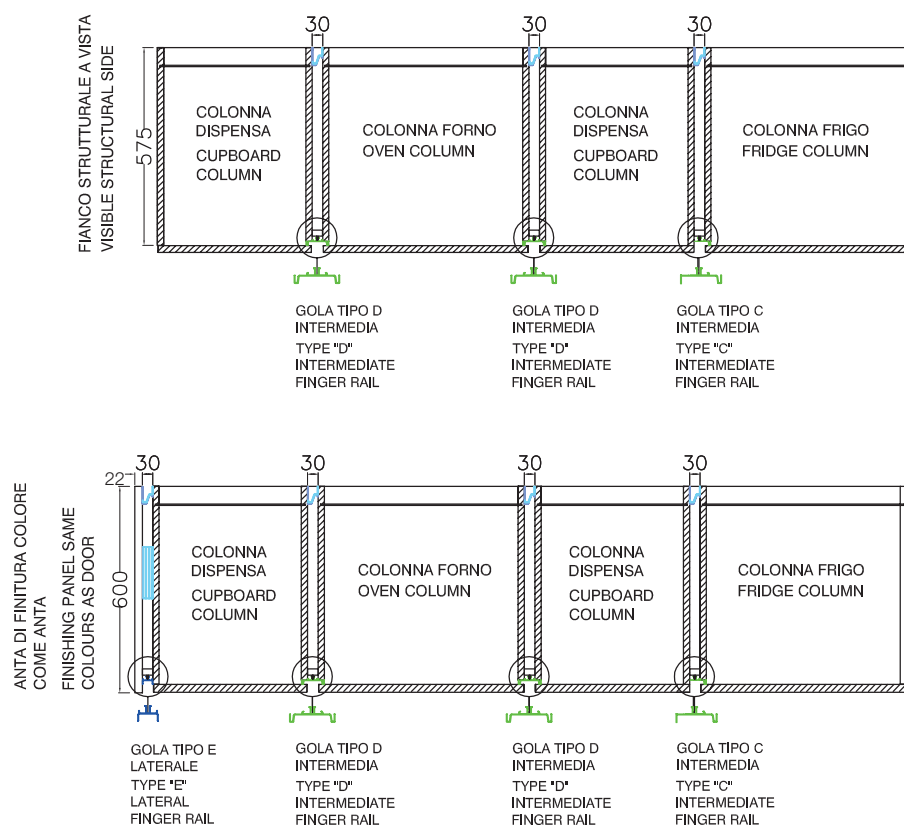

Composizione fianco strutturale  
a vista come anta:  
alla dimensione finale della cucina,  
sommare sempre lo spessore dei  
distanziali tra le colonne  
(ogni distanziale 3 cm)

Composition with visible side panel to match door:  
to the final size of the kitchen, always add the thickness  
of the spacers between the two columns (each spacer 3 cm)

Composizione con ante di finitura  
laterali, alla dimensione finale della  
cucina, sommare sempre lo spessore  
dei distanziali tra le colonne  
(ogni distanziale 3 cm) e lo spessore  
delle ante di finitura (ogni anta 2,2 cm)

Composition with side finishing panels to the final size of the  
kitchen, always add the thickness of the spacer between the  
two columns (each spacer 3 cm) and the thickness of the  
finishing panels (each panel 22 mm)



## DI SERIE STANDARD



Maniglia U1  
 anta L 15 → passo 96 mm  
 anta L 30 a L 45 → passo 160 mm  
 anta da L 60 a L 120 → passo 320 mm

Handle U1  
 door W 15 → centre-to-centre distance 96 mm  
 door W 30 to W 45 → centre-to-centre distance 160 mm  
 door from W 60 to W 120 → centre-to-centre distance 320 mm

Maniglia U1S finitura silver dark  
 Handle U1S dark silver finish

Maniglia U1N finitura nero  
 Handle U1N black finish

Maniglia U1K finitura nichel satinato  
 Handle U1K satin nickel finish

**N.B.:** per la colonna Nook è consigliato l'abbinamento con la maniglia 940 finitura titanio  
**Note:** the combination is recommended for the Nook column with the 940 titanium finish handle

## A RICHIESTA ON REQUEST



Maniglia U3  
 anta L 15 → passo 96 mm  
 anta L 30 a L 45 → passo 160 mm  
 anta da L 60 a L 120 → passo 320 mm

Handle U3  
 door W 15 → centre-to-centre distance 96 mm  
 door W 30 to W 45 → centre-to-centre distance 160 mm  
 door from W 60 to W 120 → centre-to-centre distance 320 mm

Maniglia U3T finitura titanio  
 Handle U3T titanium finish

## A RICHIESTA ON REQUEST



Maniglia U2  
 anta L 15 → passo 64 mm  
 anta L 30 a L 45 → passo 160 mm  
 anta da L 60 a L 120 → passo 320 mm

Handle U2  
 door W 15 → centre-to-centre distance 64 mm  
 door W 30 to W 45 → centre-to-centre distance 160 mm  
 door from W 60 to W 120 → centre-to-centre distance 320 mm

Maniglia U2S finitura silver dark  
 Handle U2S dark silver finish

Maniglia U2G finitura grigio selce  
 Handle U2G flint grey finish

**N.B.:** per la colonna Nook è consigliato l'abbinamento con la maniglia 940 finitura silver dark  
**Note:** the combination is recommended for the Nook column with the 940 dark silver finish handle

## A RICHIESTA ON REQUEST



Maniglia U4  
 anta L 15 → passo 160 mm in verticale  
 anta L 30 a L 45 → passo 160 mm  
 anta da L 60 a L 120 → passo 320 mm

Handle U4  
 door W 15 → centre-to-centre distance 160 mm vertical  
 door W 30 to W 45 → centre-to-centre distance 160 mm  
 door from W 60 to W 120 → centre-to-centre distance 320 mm

Maniglia U4T finitura titanio  
 Handle U4T titanium finish

## A RICHIESTA ON REQUEST



Maniglia U5  
 anta L 15 → passo 160 mm in verticale  
 anta L 30 a L 45 → passo 160 mm  
 anta da L 60 a L 120 → passo 320 mm

Handle U5  
 door W 15 → centre-to-centre distance 160 mm vertical  
 door W 30 to W 45 → centre-to-centre distance 160 mm  
 door from W 60 to W 120 → centre-to-centre distance 320 mm

Maniglia U5F finitura grafite spazzolato  
 Handle U5F brushed graphite finish

**N.B.:** per la colonna Nook è consigliato l'abbinamento con la maniglia 940 finitura silver dark  
**Note:** the combination is recommended for the Nook column with the 940 dark silver finish handle

## A RICHIESTA ON REQUEST



Maniglia U6  
 anta L 15 → passo 96 mm  
 anta L 30 a L 45 → passo 160 mm  
 anta da L 60 a L 120 → passo 320 mm

Handle U6  
 door W 15 → centre-to-centre distance 96 mm  
 door W 30 to W 45 → centre-to-centre distance 160 mm  
 door from W 60 to W 120 → centre-to-centre distance 320 mm

Maniglia U6R finitura tortora  
 Handle U6R dove grey finish

Maniglia U6N finitura nero  
 Handle U6N black finish

Maniglia U6K finitura nichel satinato  
 Handle U6K satin nickel finish

**N.B.:** per la colonna Nook è consigliato l'abbinamento con la maniglia 940 finitura titanio  
**Note:** the combination is recommended for the Nook column with the 940 titanium finish handle

## A RICHIESTA ON REQUEST



Maniglia U7 ad incasso  
 anta L 15 → passo 64 mm  
 anta L 30 a L 45 → passo 160 mm  
 anta da L 60 a L 120 → passo 288 mm

Built-in handle U7  
 door W 15 → centre-to-centre distance 64 mm  
 door W 30 to W 45 → centre-to-centre distance 160 mm  
 door from W 60 to W 120 → centre-to-centre distance 288 mm

Maniglia U7R finitura tortora  
 Handle U7R dove grey finish

**N.B.:** per la colonna Nook è consigliato l'abbinamento con la maniglia 940 finitura titanio  
 Note: the combination is recommended for the Nook column with the 940 titanium finish handle

## A RICHIESTA ON REQUEST

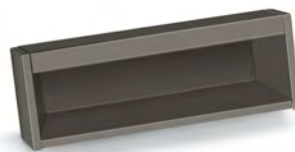

Maniglia 947 ad incasso  
 anta L 15 → dimensioni L 85  
 anta da L 30 a L 45 → dimensioni L 190  
 anta da L 60 a L 120 → dimensioni L 340

Built-in handle 947  
 door W 15 → dimensions W 85  
 door from W 30 to W 45 → dimensions W 190  
 door from W 60 to W 120 → dimensions W 340

Maniglia 947S finitura silver dark  
 Handle 947S dark silver finish

Maniglia 947T finitura titanio  
 Handle 947T titanium finish

## A RICHIESTA ON REQUEST



Maniglia U9  
 anta L 15 → passo 64 mm  
 anta L 30 a L 45 → passo 160 mm  
 anta da L 60 a L 120 → passo 320 mm

Handle U9  
 door W 15 → centre-to-centre distance 64 mm  
 door W 30 to W 45 → centre-to-centre distance 160 mm  
 door from W 60 to W 120 → centre-to-centre distance 320 mm

Maniglia U9K finitura nichel satinato  
 Handle U9K satin nickel finish

**N.B.:** per la colonna Nook è consigliato l'abbinamento con la maniglia 940 finitura titanio  
 Note: the combination is recommended for the Nook column with the 940 titanium finish handle

## A RICHIESTA ON REQUEST

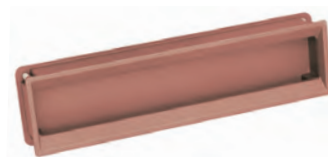

Maniglia 940 ad incasso  
 dimensioni mm L 182 H 47  
**N.B.:** utilizzata anche per colonne nook

Built-in handle 940  
 dimensions W 182 H 47 mm  
 Note: also used for nook columns

Maniglia 940T finitura titanio  
 Handle 940T titanium finish

Maniglia 940P finitura rosso persia  
 Handle 940P persia red finish

Maniglia 940Z finitura azzurro nube  
 Handle 940Z cloud blue finish

Maniglia 940S finitura silver dark  
 Handle 940S dark silver finish

Maniglia 940N finitura nero  
 Handle 940N black finish

## A RICHIESTA ON REQUEST



Maniglia U8  
 anta L 15 → passo 32 mm  
 anta L 30 a L 40 → passo 96 mm  
 anta da L 45 a L 60 → passo 224 mm  
 anta da L 65 a L 120 → passo 384 mm

Handle U8  
 door W 15 → centre-to-centre distance 32 mm  
 door W 30 to W 40 → centre-to-centre distance 96 mm  
 door W 45 to W 60 → centre-to-centre distance 224 mm  
 door from W 65 to W 120 → centre-to-centre distance 384 mm

Maniglia U8S finitura silver dark  
 Handle U8S dark silver finish

Maniglia U8T finitura titanio  
 Handle U8T titanium finish

# MANIGLIE HANDLES

Neck con maniglia  
with handle

## DI SERIE STANDARD

Maniglia finitura titanio ossidato (opz.962T)  
anta L 15 dimensioni mm L 100 H 18  
anta da L 30 a L 120 dimensioni mm L 200 H 18  
Handle titanium (opt.962T) finish  
door W 15 dimensions W 100 H 18 mm  
door from W 30 to W 120 dimensions W 200 H 18 mm



## A RICHIESTA ON REQUEST

Maniglia finitura silver dark (opz.962S)  
anta L 15 dimensioni mm L 100 H 18  
anta da L 30 a L 120 dimensioni mm L 200 H 18  
Handle dark silver (opt.962S) finish  
door W 15 dimensions W 100 H 18 mm  
door from W 30 to W 120 dimensions W 200 H 18 mm



Maniglia finitura rosso persia (opz.962P)  
anta L 15 dimensioni mm L 100 H 18  
anta da L 30 a L 120 dimensioni mm L 200 H 18  
Handle persia red (opt.962P) finish  
door W 15 dimensions W 100 H 18 mm  
door from W 30 to W 120 dimensions W 200 H 18 mm

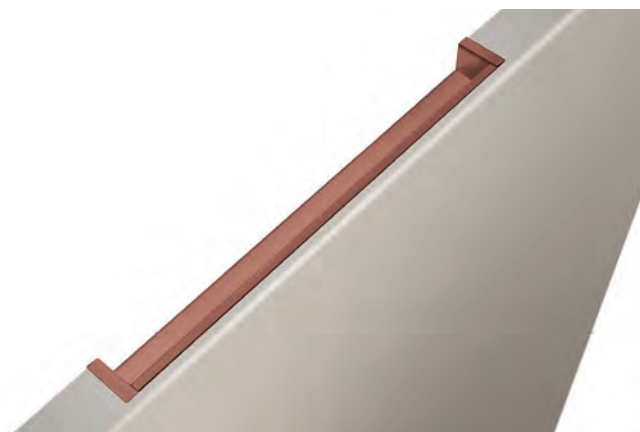

Maniglia finitura nero (opz.962N)  
anta L 15 dimensioni mm L 100 H 18  
anta da L 30 a L 120 dimensioni mm L 200 H 18  
Handle black (opt.962N) finish  
door W 15 dimensions W 100 H 18 mm  
door from W 30 to W 120 dimensions W 200 H 18 mm



Maniglia finitura azzurro nube (opz.962Z)  
anta L 15 dimensioni mm L 100 H 18  
anta da L 30 a L 120 dimensioni mm L 200 H 18  
Handle cloud blue (opt.962Z) finish  
door W 15 dimensions W 100 H 18 mm  
door from W 30 to W 120 dimensions W 200 H 18 mm

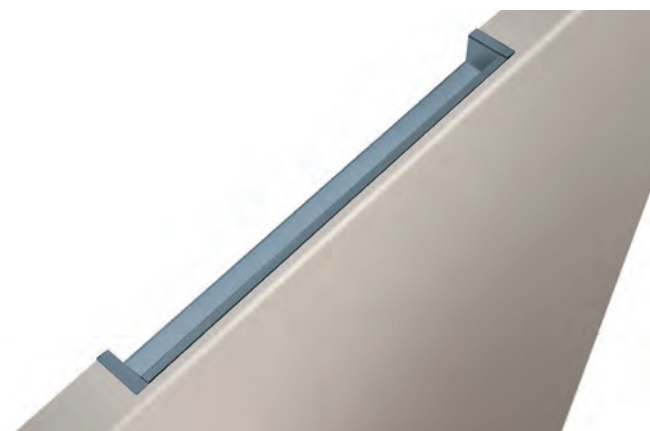

# MANIGLIE HANDLES

Maniglia pensile  
Handle wall unit

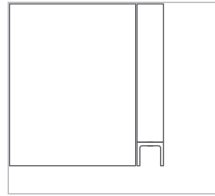

Maniglia base  
Handle base unit

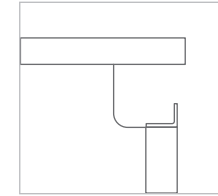

Finitura disponibile di serie:  
Available finish standard



titanio ossidato (opt.PLUT)  
titanium oxidized (opt.PLUT)

Finiture disponibili a richiesta  
Available finishes on request



rosso persia (opt.PLUP)  
persia red (opt.PLUP)



azzurro nube (opt.PLUZ)  
cloud blue (opt.PLUZ)



nero (opt.PLUN)  
black (opt.PLUN)



silver dark (opt.PLUS)  
dark silver (opt.PLUS)

maniglia pensile  
handle wall unit

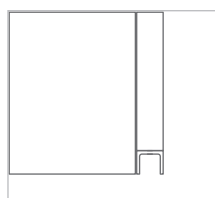

per anta L 15  
per anta L 30  
per angolo a libro  
per anta L 40  
per anta L 45  
per anta L 60  
per anta L 65  
per anta L 75  
per anta L 76  
per anta L 90  
per anta L 91  
per anta L 120  
per angolare

maniglia base  
handle base unit

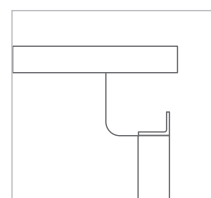

per anta L 15  
per anta L 30  
per anta L 40  
per anta L 45  
per anta L 60  
per anta L 65  
per anta L 75  
per anta L 90  
per anta L 120  
per angolare

## MANIGLIE HANDLES

Maniglia pensile  
Handle wall unit

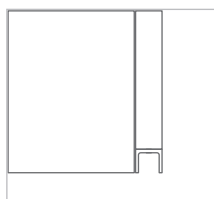

Maniglia base  
Handle base unit

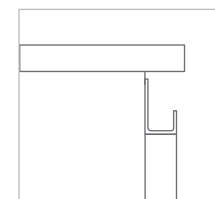

Maniglie colonna 2 ante  
Column handles 2 doors

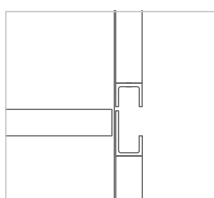

Maniglia colonna anta unica  
Column handle with single door

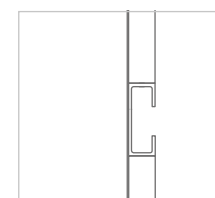

Finitura disponibile di serie:  
Available finish standard



titanio ossidato (opz.UHT)  
titanium oxidized (opt.UHT)

Finiture disponibili a richiesta  
Available finishes on request



rosso persia (opz.UHP)  
persia red (opt.UHP)



azzurro nube (opz.UHZ)  
cloud blue (opt.UHZ)



nero (opz.UHN)  
black (opt.UHN)



silver dark (opz.UHS)  
dark silver (opt.UHS)

maniglia pensile  
handle wall unit

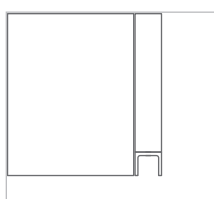

per anta L 15  
per anta L 30  
per angolo a libro  
per anta L 40  
per anta L 45  
per anta L 60  
per anta L 65  
per anta L 75  
per anta L 76  
per anta L 90  
per anta L 91  
per anta L 120  
per angolare

maniglia base  
handle base unit

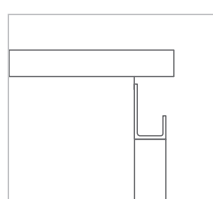

per anta L 15  
per anta L 30  
per anta L 40  
per anta L 45  
per anta L 60  
per anta L 65  
per anta L 75  
per anta L 76  
per anta L 90  
per anta L 120  
per angolare

maniglia colonna anta unica  
column handle with single door

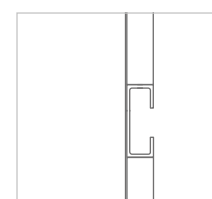

per anta L 30  
per anta L 45  
per anta L 60  
per anta L 75



# SCHIENA EFFETTO MARMO BACK PANEL MARBLE EFFECT

## PENSILI

WALL UNITS

H 36-48 L 45

L 60

L 90

H 60 L 60

H 72 L 45

L 60

L 90

H 96 L 45

L 60

L 90

H 108 L 45

L 60

L 90

H 120 L 45

## BASI

BASE UNITS

H 72 L 45

L 60

L 90

H 75 L 45

L 60

L 90

## COLONNE

COLUMNS

H 132 L 45

L 60

L 90

H 204 L 45

L 60

L 90

## COLORI SCHIENA

BACK PANEL COLOUR

**N.B.:** solo per elementi a vetro Note: only for glass elements

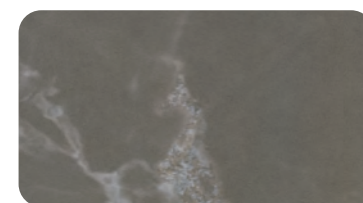

**perlato finitura ker (opz.3443)**  
pearly with ker finish



**alabastro finitura mn (opz.6014)**  
alabaster with mn finish

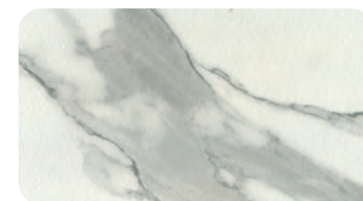

**calacatta finitura mn (opz.6019)**  
calacatta with mn finish

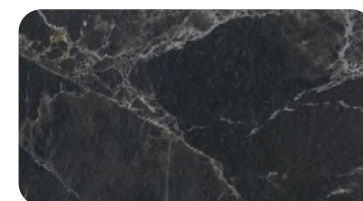

**dark finitura mn (opz.6133)**  
dark with mn finish

## strutture carcasses



bianco (opz.001)  
schiena e ripiano bianco  
(opz.001)  
white (opt.001)  
white back panel and shelf  
(opt.001)



visone (opz.948M)  
schiena e ripiano visone  
(opz.948M)  
mink (opt.948M)  
mink back panel and shelf  
(opt.948M)



lavagna (opz.9620)  
schiena e ripiano lavagna  
(opz.9620)  
slate grey (opt.9620)  
slate grey back panel  
and shelf (opt.9620)



fango (opz.8860)  
schiena e ripiano fango  
(opz.8860)  
mud (opt.8860)  
mud back panel and shelf  
(opt.8860)



conchiglia (opz.8910)  
schiena e ripiano conchiglia  
(opz.8910)  
shell (opt.8910)  
shell back panel and shelf  
(opt.8910)

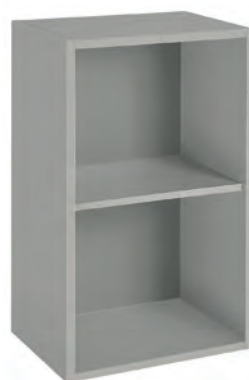

argilla (opz.9690)  
schiena e ripiano argilla  
(opz.9690)  
clay (opt.9690)  
clay back panel and shelf  
(opt.9690)



lino effetto tela (opz.8920)  
schiena e ripiano conchiglia  
(opz.8910)  
linen melamine-coated canvas  
effect (opt.8920)  
shell back panel and shelf (opt.8910)

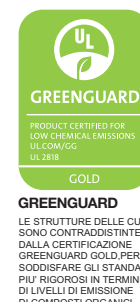

## mensole in laminato P 31-61 come strutture same colours as carcasses laminate shelves D 31-61



bianco (opz.001)  
white (opt.001)

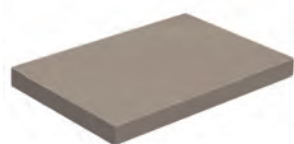

visone (opz.948M)  
mink (opt.948M)

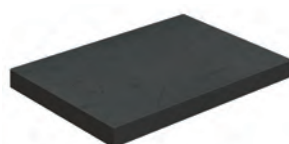

lavagna (opz.9620)  
slate grey (opt.9620)



conchiglia (opz.8910)  
shell (opt.8910)

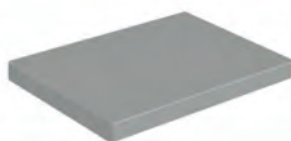

argilla (opz.9690)  
clay (opt.9690)

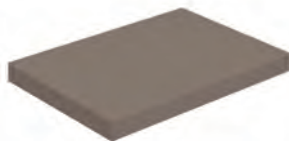

fango (opz.8860)  
mud (opt.8860)



melaminico come ante  
N.B.: per le finiture vedi pagine 12-13  
melamine same finish as doors  
Note: for the finishes see pages 12-13

---

## zoccoli in pvc H 13 pvc plinths H 13

di serie  
standard



acciaio (opz.407)  
steel (opt.407)



alluminio satinato  
(opz.405)  
satin aluminium  
(opt.405)



bianco (opz.001)  
white (opt.001)

---

## zoccoli in alluminio H 13 aluminium plinths H 13



alluminio  
finitura brill (opz.412)  
aluminium  
brill finish (opt.412)



alluminio finitura titanio  
ossidato (opz.414)  
aluminium titanium  
oxidized finish (opt.414)

## zoccoli in alluminio H 13 verniciati a polvere finitura opaca aluminium plinths H 13 powder coated matt finish



alluminio finitura  
ghisa (opz.9509)  
aluminium cast iron  
finish (opt.9509)



alluminio finitura  
fumo (opz.9531)  
aluminium  
smoke finish (opt.9531)



alluminio finitura  
silver dark (opz.9507)  
aluminium dark silver  
finish (opt.9507)



alluminio finitura  
bianco assoluto (opz.740S)  
aluminium absolute  
white finish (opt.740S)



alluminio grigio  
traffico (opz.9511)  
aluminium traffic grey  
finish (opt.9511)



alluminio finitura  
conchiglia (opz.7403)  
aluminium shell  
finish (opt.7403)



alluminio finitura  
argilla (opz.9503)  
aluminium clay  
finish (opt.9503)



alluminio finitura rosso  
persia (opz.8165)  
aluminium persia red  
finish (opt.8165)



alluminio lino  
(opz.W770)  
aluminium linen  
(opt.W770)



alluminio finitura  
grigio selce (opz.SE)  
aluminium flint grey  
finish (opt.SE)



alluminio finitura  
azzurro nube  
(opz.8379)  
aluminium cloud blue  
finish (opt.8379)



alluminio finitura grigio  
kenia (opz.9501)  
aluminium kenia grey  
finish (opt.9501)



# MODULARITÀ E COMPONIBILITÀ MODULARITY AND FITTING SOLUTIONS

COLONNE FRIGO  
FRIDGE COLUMNS

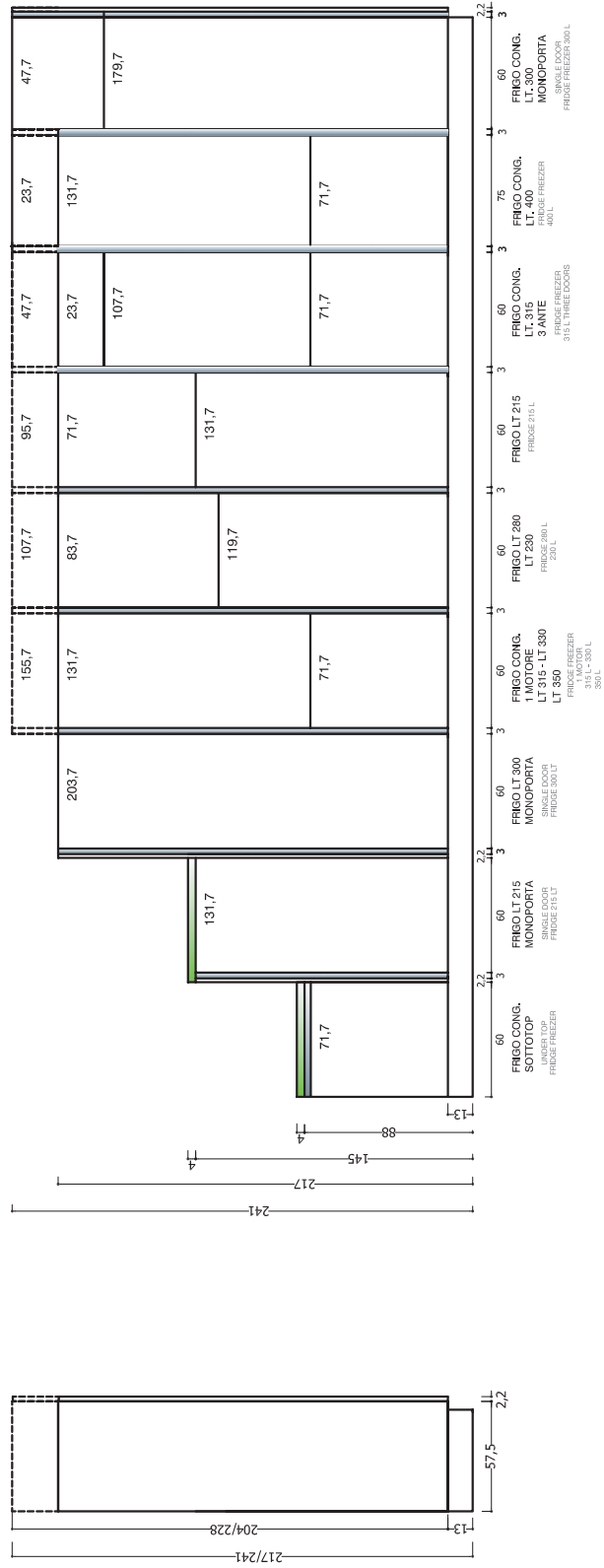

COLONNE FORNO  
OVEN COLUMNS

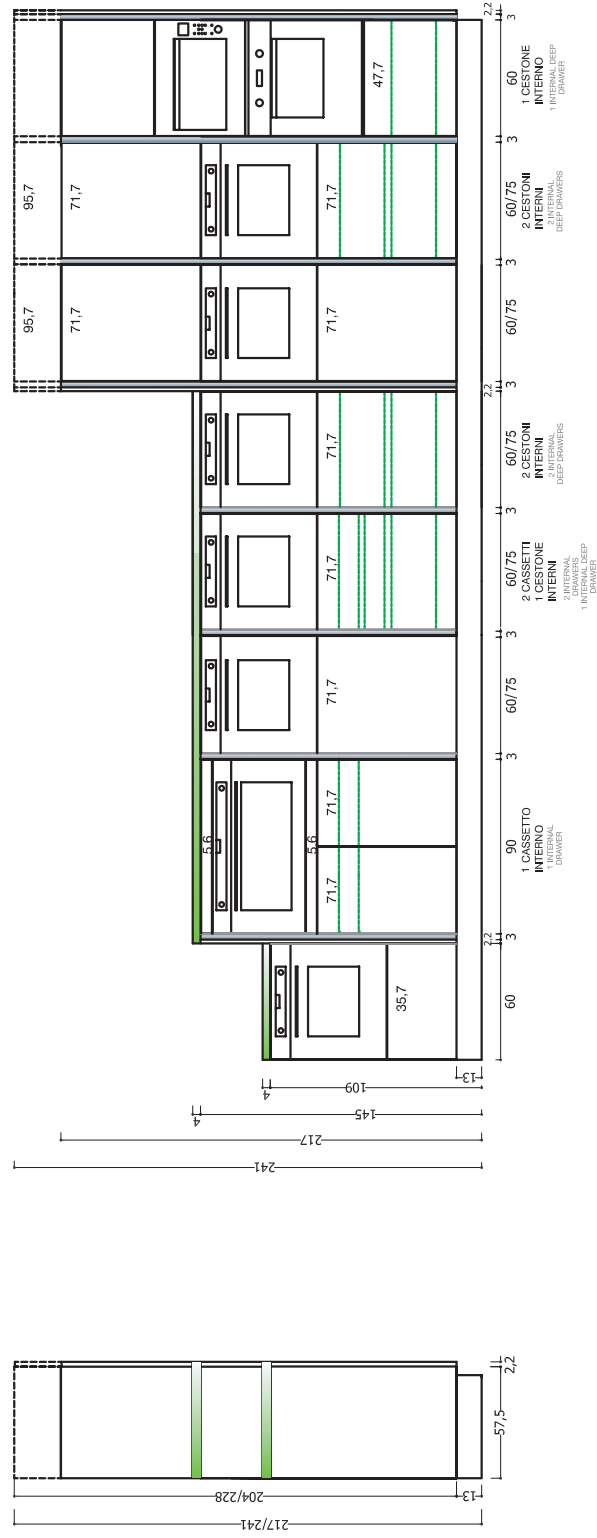



## MODULARITÀ E COMPONIBILITÀ MODULARITY AND FITTING SOLUTIONS

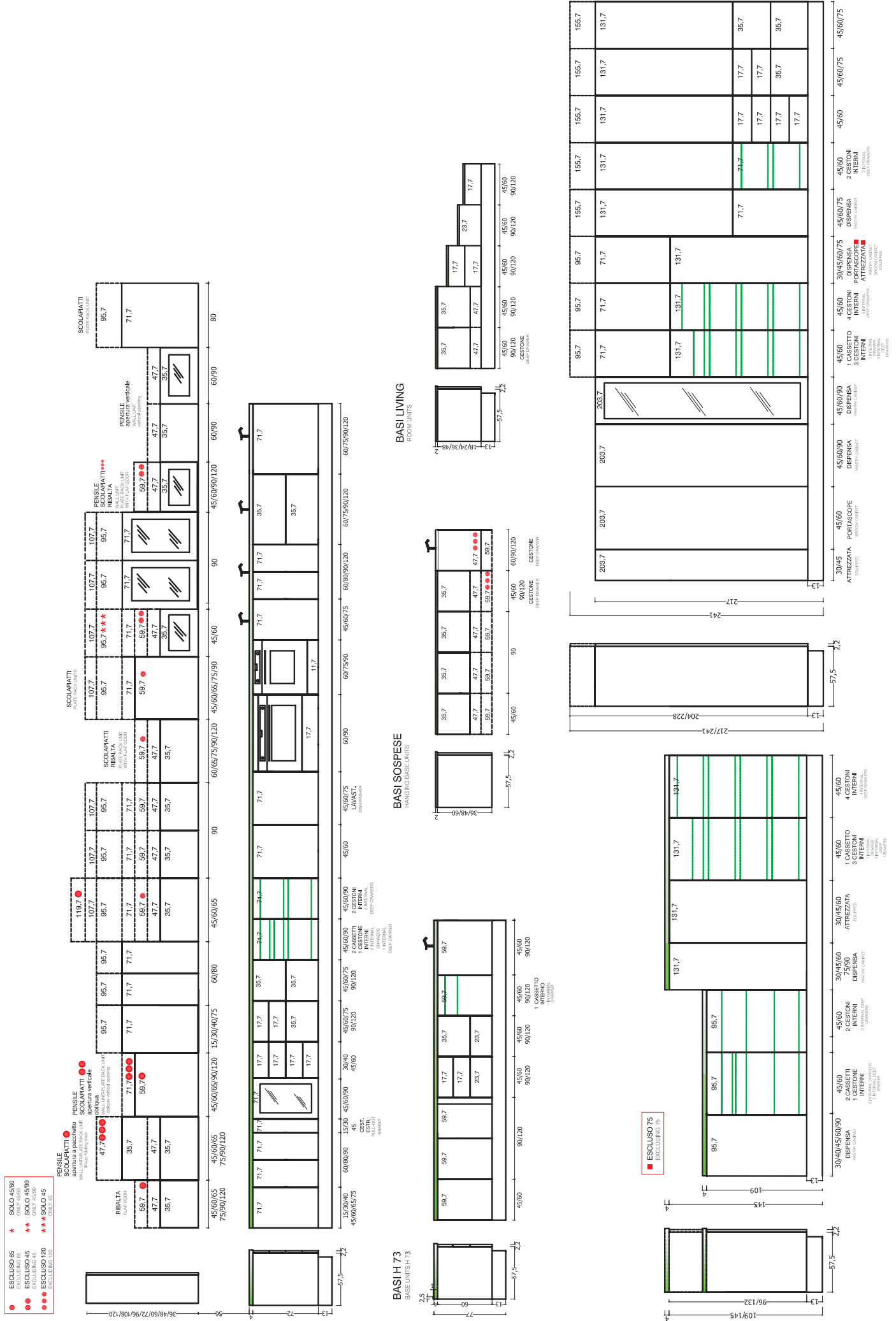



**APERTURA A RIBALTA**

Le ante aprendosi verso l'alto consentono di avere un' ampia visione d'insieme all'interno del mobile.

La regolazione della forza di apertura può essere impostata in modo esatto in base al peso del frontale. Grazie all'arresto progressivo le ante si fermano in qualsiasi posizione; in questo modo la maniglia è sempre facilmente raggiungibile. La chiusura è ammortizzata e un'unica manovra è sufficiente per regolare il frontale tridimensionalmente grazie all'assenza di cerniere e al sistema di aggancio clip.

WALL UNIT WITH FLAP DOOR

The doors that open upwards guarantee ample overall visibility inside the cabinet.

The opening force can be adjusted precisely according to the weight of the front. The doors stop in any position thanks to the gradual stopping movement; in this way, the handle is always easily accessible. The closing movement is cushioned and a single manoeuvre is required to three-dimensionally adjust the front, thanks to the clip-on system and the absence of hinges.



**DI SERIE  
STANDARD**



**MOTORIZZATO  
SERVO-DRIVE  
SERVO-DRIVE  
MOTORISED  
(Opz.007)**

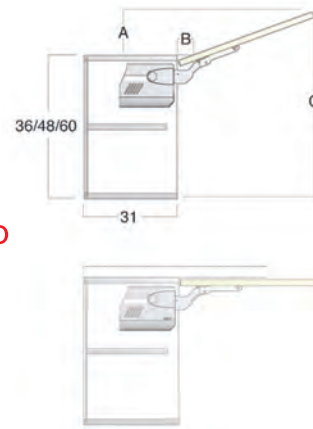

	A	B	C
H 36	11,5	3,5	37
H 48	15	3,5	49
H 60	18,5	3,5	61

Per evitare l'interferenza dell'anta in fase di apertura con cornici o mensole, si può richiedere il limitatore dell'angolo di apertura cod. 5620010

In order to avoid that the door interferes with cornices or shelves during the opening movement, it is possible to request an opening angle limiter: code 5620010

**SCHEMA MONTAGGIO LIMITATORE  
PER RIBALTA H 36  
FLAP DOOR LIMITER INSTALLATION  
DIAGRAM H 36**

**SCHEMA MONTAGGIO LIMITATORE  
PER RIBALTA H 48  
FLAP DOOR LIMITER INSTALLATION  
DIAGRAM H 48**

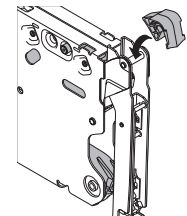
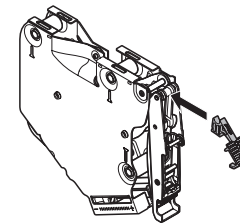

**APERTURA VERTICALE OBLIQUA**

I pensili con questo tipo di meccanismo necessitano per l'apertura di poco spazio libero sopra il mobile grazie al movimento basculante dell'anta che si apre senza difficoltà applicando poca forza anche in presenza di frontali pesanti. Con l'arresto progressivo le ante si fermano in qualsiasi posizione; in questo modo la maniglia è sempre facilmente raggiungibile. La chiusura è ammortizzata ed è possibile regolare la forza di tenuta in base al peso del frontale.

VERTICAL OPENING OBLIQUE

Wall units that mount this type of mechanism require little clearance above the cabinet thanks to the swivelling movement of the door that can be easily opened by applying slight pressure, even with heavy fronts. The doors stop in any position thanks to the gradual stopping movement; in this way, the handle is always easily accessible. The closing movement is cushioned and the closing force can be adjusted according to the weight of the front door.



**DI SERIE  
STANDARD**



**MOTORIZZATO  
SERVO-DRIVE  
SERVO-DRIVE  
MOTORISED  
(Opz.007)**

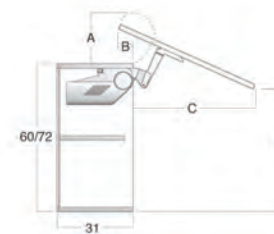

	A	B	C	D
H 60	18	9,6	46,5	53,5
H 72	18	9,6	57	61

**APERTURA VERTICALE**

L'anta ad apertura verticale, potendo essere sollevata completamente verso l'alto, consente un accesso totale all'interno del pensile. Ideale per l'impiego in mobili a colonna per nascondere ad esempio apparecchi elettrici, o pensili con corpi mobili sovrastanti, ha la chiusura ammortizzata e la possibilità di regolare la forza di tenuta in base al peso del frontale.

VERTICAL OPENING

Doors with vertical opening movement can be fully raised to fully access the inside of the wall unit.

Ideal for use on column units to conceal electrical appliances for examples, or on wall units surmounted by mobile units.

The closing movement is cushioned and the closing force can be adjusted according to the weight of the front door.



**DI SERIE STANDARD**



**MOTORIZZATO SERVO-DRIVE**  
SERVO-DRIVE  
MOTORISED  
(Opz.007)

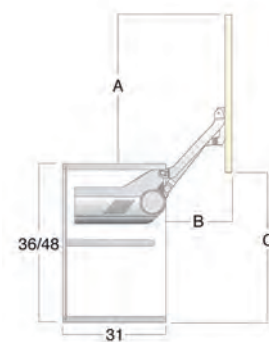

	A	B	C
H 36	34	23,5	34,5
H 48	43	28,5	43,5

**APERTURA ANTE A PACCHETTO**

Il meccanismo d'apertura ante a pacchetto è idoneo sul pensile H 72; la regolazione della forza di apertura può essere impostata in modo esatto in base ai pesi dei frontali, la chiusura è ammortizzata e la cerniera centrale clip si contraddistingue per l'innovativa tecnologia che garantisce la sicurezza per le dita.

LIFT-UP FOLDING DOORS

The lift-up folding door opening mechanism is suitable for wall units with H 72; the opening force can be adjusted precisely according to the weight of the fronts, while the closing movement is cushioned and the central clip-on hinge features innovative technology for safeguarding the fingers.



**DI SERIE STANDARD**



**MOTORIZZATO SERVO-DRIVE**  
SERVO-DRIVE  
MOTORISED  
(Opz.007)

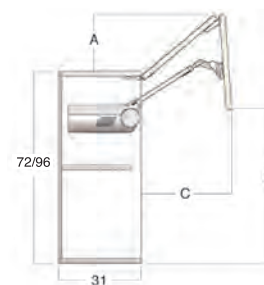

	A	B	C
H 72	16,5	54	41
H 96	20	69	53

**SCHEMA MONTAGGIO LIMITATORE**  
LIMITER INSTALLATION  
DIAGRAM

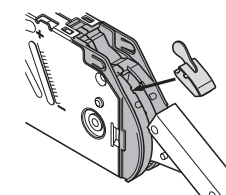

**Per evitare l'interferenza dell'anta in fase di apertura con cornici o mensole, si può richiedere il limitatore dell'angolo di apertura cod. 5620005**

In order to avoid that the door interferes with cornices or shelves during the opening movement, it is possible to request an opening angle limiter: code 5620005



## COLONNE ARMADIO “NOOK” H 217 P 70,4 CON ANTE A SCOMPARSA

“NOOK” CLOSET COLUMNS H 217 D 70,4 WITH DOORS INWARDS

Le colonne armadio “Nook” con ante a scomparsa, consentono di inserire all’interno forno, frigo, tavolo e cassetti

“Nook” closet columns with pull-out doors allow to insert oven, fridge, table and drawer on the inside



## COLONNE ARMADIO “NOOK” H 217 P 70,4 CON ANTE A SCOMPARSA

“NOOK” CLOSET COLUMNS H 217 D 70,4 WITH DOORS INWARDS

Il tavolo estraibile è disponibile nella versione inox o in laminato, nella finitura oak cognac











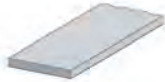
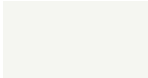





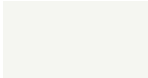

The pull-out table it's available in stainless steel version or laminate oak cognac finish



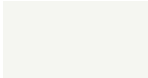

# MENSOLE

SHELVES

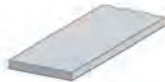
	COD.			COD.							
<p><b>mensola sp. 3,8 in nobilitato colori strutture</b>  <b>L max cm 400</b>                      melamine shelf Th. 3.8, colours carcasses                      max. length 400 cm</p>  <p>Colori strutture                      Structure colours</p> <table border="0"> <tr> <td> bianco (opz.001) white</td> <td> visone (opz.948M) mink</td> <td> argilla (opz.9690) clay</td> </tr> <tr> <td> lavagna (opz.9620) slate grey</td> <td> fango (opz.8860) mud</td> <td> conchiglia (opz.8910) shell</td> </tr> </table>	 bianco (opz.001) white	 visone (opz.948M) mink	 argilla (opz.9690) clay	 lavagna (opz.9620) slate grey	 fango (opz.8860) mud	 conchiglia (opz.8910) shell			<p><b>reggimensola a scomparsa</b>                      fully integrated shelf bracket</p> 		
	 bianco (opz.001) white	 visone (opz.948M) mink	 argilla (opz.9690) clay								
	 lavagna (opz.9620) slate grey	 fango (opz.8860) mud	 conchiglia (opz.8910) shell								
			08610400								
	091523										
	091560										
<p><b>mensola sp. 3,8 in melaminico, L max cm 275</b>  <b>finiture come ante vedi pag.12-13</b>                      melamine shelf Th. 3.8, max. length 275 cm                      same finishes as doors see page.12-13</p> 											
		091523									
	091560										

# CABINA RIPOSTIGLIO

CLOSET COLUMN



## COLORI ANTE CHIUSE E PANNELLI FISSI FRONTALE E LATERALE COLOURS FOR DOORS AND FIXED FRONT LATERAL PANELS



**MELAMINICO** per colori vedi pag.12-13  
MELAMINE for colours see page 12-13

## ANTE VETRO GLASS DOORS

**N.B.:** per colori vedi pag. 14-15  
**NOTE:** for colours see pages 14-15



telaio grigio selce  
con vetro trasparente  
(opz.UNGT)  
flint grey frame with  
transparent glass  
(opt.UNGT)



telaio grigio selce  
con vetro satinato  
(opz.UNGS)  
flint grey frame with  
satin glass (opt.UNGS)

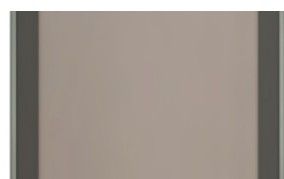

telaio grigio selce  
con vetro bronzo satinato  
(opz.UNGB)  
flint grey frame with  
satin bronze glass  
(opt.UNGB)



telaio silver dark  
con vetro trasparente  
(opz.UNST)  
dark silver frame with  
transparent glass  
(opt.UNST)



telaio silver dark  
con vetro satinato  
(opz.UNSS)  
dark silver frame with  
satin glass  
(opt.UNSS)



telaio silver dark  
con vetro fumè satinato  
(opz.UNSF)  
dark silver frame with  
smoked satin glass  
(opt.UNSF)



telaio nero  
con vetro trasparente  
(opz.UNNT)  
black frame with  
transparent glass  
(opt.UNNT)



telaio nero  
con vetro satinato  
(opz.UNNS)  
black frame with  
satin glass  
(opt.UNNS)



telaio nero  
con vetro fumè satinato  
(opz.UNNF)  
black frame with  
smoked satin glass  
(opt.UNNF)

## COLORI STRUTTURA INTERNA IN NOBILITATO COLOURS FOR INTERNAL MELAMINE-COATED STRUCTURE

bianco (opz.001) white	visone (opz.948M) mink	lavagna (opz.9620) slate grey	fango (opz.8860) mud	conchiglia (opz.8910) shell	argilla (opz.9690) clay
lino effetto tela (opz.8920) linen melamin-coated canvas					



# MOBILI "BREAK" CON VASCHETTA IN METALLO

"BREAK" FURNITURE WITH METAL TRAY



## COLORI VASCHETTA TRAY COLOURS

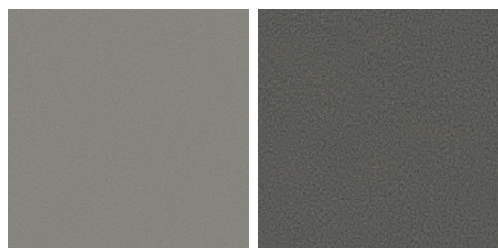

grigio selce (opz.95SE) silver dark (opz.9507)  
flint grey dark silver

## COLORI STRUTTURE E ANTE IN MELAMINICO CARCASS AND DOORS MELAMINE COLOURS

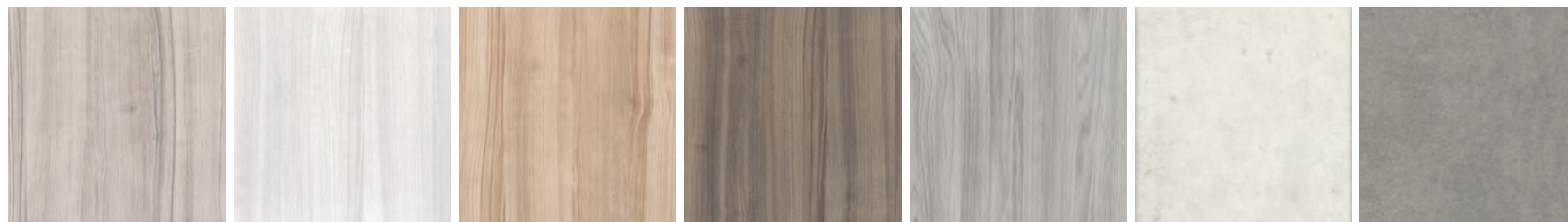

phagos nuvola finitura chiselled (opz.1567) chiselled finish cloud phagos  
phagos bianco finitura chiselled (opz.1566) chiselled finish white phagos  
phagos kapok finitura chiselled (opz.1560) chiselled finish kapok phagos  
phagos vulcano finitura chiselled (opz.1568) chiselled finish vulcano phagos  
perla finitura rovere naturale (opz.5314) pearl natural oak finish  
platino finitura effetto ossidato (opz.9661) platinum oxidized effect finish  
pietra grey finitura materica (opz.9642) grey stone textured finish

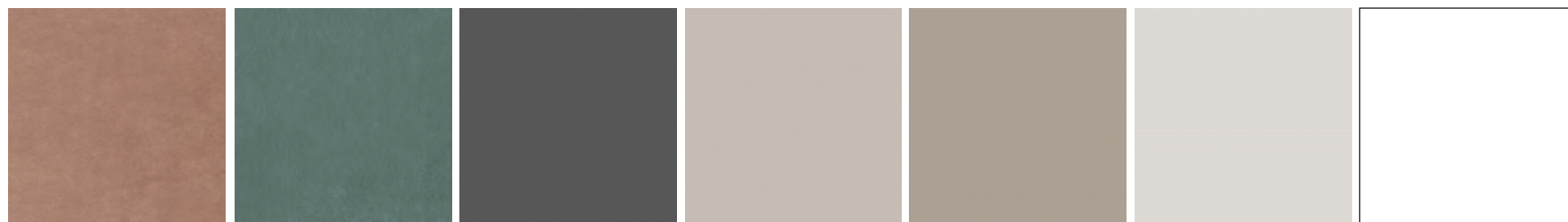

pietra fulvus finitura materica (opz.8867) fulvus stone textured finish  
pietra musk finitura materica (opz.8403) musk stone textured finish  
antracite finitura seta tinta unita (opz.9643) anthracite solid color silk finish  
dove grey finitura seta tinta unita (opz.8971) grey dove solid color silk finish  
ecru finitura seta tinta unita (opz.9641) ecru solid color silk finish  
grigio chiaro finitura seta tinta unita (opz.9640) clear grey solid color silk finish  
bianco assoluto finitura seta tinta unita (opz.7450) absolute white solid color silk finish

# MOBILI A GIORNO SP. 18 MM

OPEN FORNITURE TH.18 MM



## COLORI MELAMINICI MELAMINE COLOURS

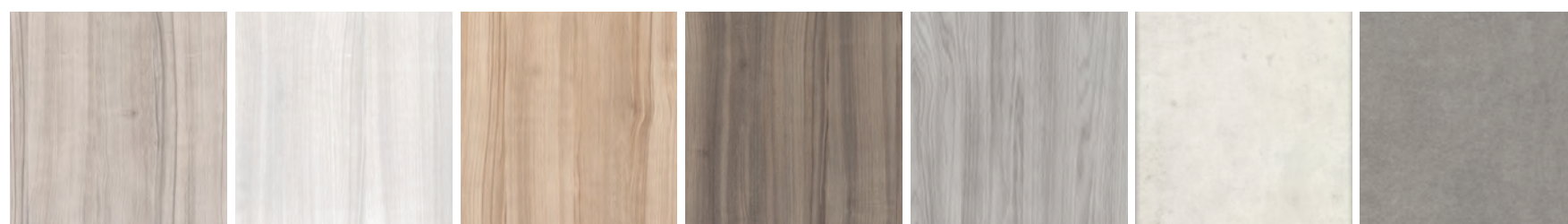

phagos nuvola finitura  
chiselled (opz.1567)  
chiselled finish cloud  
phagos

phagos bianco finitura  
chiselled (opz.1566)  
chiselled finish white  
phagos

phagos kapok finitura  
chiselled (opz.1560)  
chiselled finish kapok  
phagos

phagos vulcano finitura  
chiselled (opz.1568)  
chiselled finish  
volcano phagos

perla finitura rovere  
naturale (opz.5314)  
pearl natural oak  
finish

platino finitura effetto  
ossidato (opz.9661)  
platinum oxidized  
effect finish

pietra grey finitura  
materica (opz.9642)  
grey stone textured  
finish



pietra fulvus finitura  
materica (opz.8867)  
fulvus stone textured  
finish



pietra musk finitura  
materica (opz.8403)  
musk stone textured  
finish

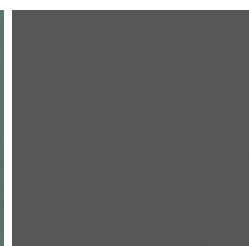

antracite finitura seta  
tinta unita (opz.9643)  
anthracite solid color  
silk finish



dove grey finitura seta  
tinta unita (opz.8971)  
grey dove solid color  
silk finish

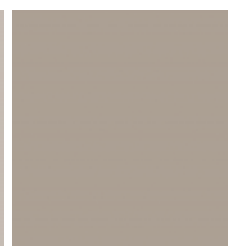

ecru finitura seta  
tinta unita (opz.9641)  
ecru solid color  
silk finish

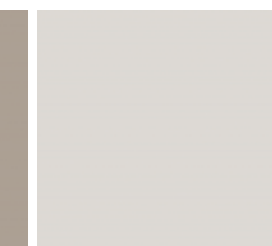

grigio chiaro finitura  
seta tinta unita  
(opz.9640)  
clear grey solid color  
silk finish



bianco assoluto finitura  
seta tinta unita (opz.7450)  
absolute white solid color  
silk finish







# ELEMENTI A GIORNO “UNI-CODE”

“UNI-CODE” OPEN UNITS



## COLORI MONTANTI IN METALLO COLOURS METAL ELEMENTS



grigio selce (opz.95SE) nero (opz.7892) silver dark (opz.9507)  
flint grey black dark silver

## COLORI MENSOLE MELAMINICO SHELVES MELAMINE COLOURS

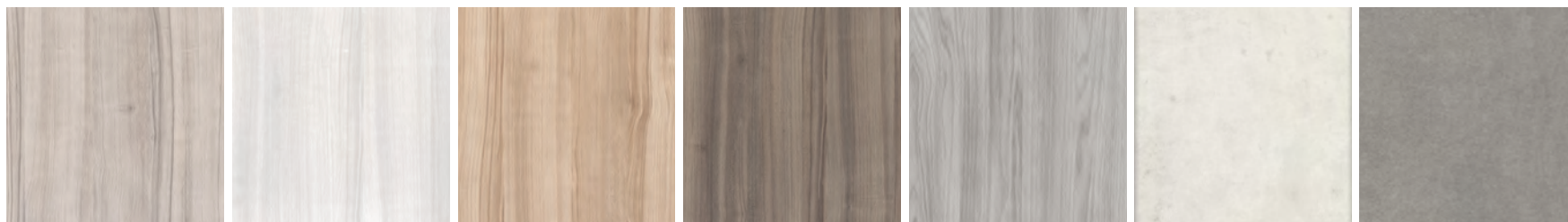

phagos nuvola finitura chiselled (opz.1567) chiselled finish cloud phagos  
phagos bianco finitura chiselled (opz.1566) chiselled finish white phagos  
phagos kapok finitura chiselled (opz.1560) chiselled finish kapok phagos  
phagos vulcano finitura chiselled (opz.1568) chiselled finish vulcano phagos  
perla finitura rovere naturale (opz.5314) pearl natural oak finish  
platino finitura effetto ossidato (opz.9661) platinum oxidized effect finish  
pietra grey finitura materica (opz.9642) grey stone textured finish

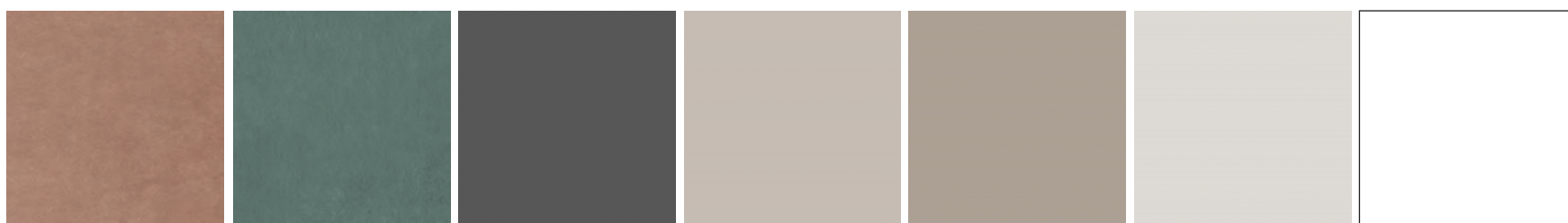

pietra fulvus finitura materica (opz.8867) fulvus stone textured finish  
pietra musk finitura materica (opz.8403) musk stone textured finish  
antracite finitura seta tinta unita (opz.9643) anthracite solid color silk finish  
dove grey finitura seta tinta unita (opz.8971) grey dove solid color silk finish  
ecru finitura seta tinta unita (opz.9641) ecru solid color silk finish  
grigio chiaro finitura seta tinta unita (opz.9640) clear grey solid color silk finish  
bianco assoluto finitura seta tinta unita (opz.7450) absolute white solid color silk finish







# VIVI IL LIVING

LIVE THE LIVING

Con i nuovi pensili più profondi  
è facilissimo creare composizioni living  
adatte ad ogni spazio.

With new more deep wall units,  
it's easy to create lively  
furnishing compositions.





# LIVING UN01



ANTE  
doors

BIANCO ASSOLUTO  
absolute white

PIETRA FULVUS  
fulvus stone

ELEMENTI A GIORNO  
open units

ANTA VETRO  
TELAIO GRIGIO SELCE  
VETRO SATINATO  
glass doors  
flint grey frame  
satin glass

GRIGIO SELCE  
flint grey

STRUTTURE  
carcasses

BIANCO  
white

VISONE  
mink

# LIVING UN01

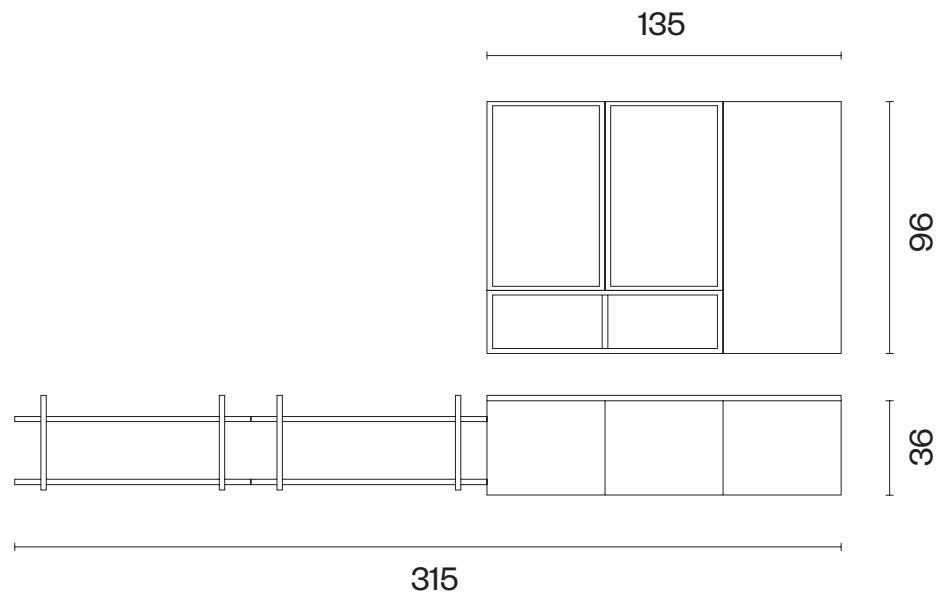

NR. ELEMENTI	DESCRIZIONE	CODICE
2	Pensile L 45 H 72 P 33,4 anta vetro apertura push pull, ripiano vetro	G1012451/2
2	Luce "VIVARA 8" L&S L 45 per ripiano vetro	08618353
1	Cavo alimentazione MC DRIVER L&S	08618020
1	Trasformatore MC DRIVER L&S	08618000
1	Distributore L&S	08618025
1	Pensile L 45 H 96 P 33,4 apertura push pull	E2020451/2
1	Elemento a giorno L 90 H 24 2 vani in melaminico come anta	E77U0004
2	Base living sospesa L 45 H 36 P 50,4 cestone apertura tip-on, fianco come anta	EBL75450
1	Base living sospesa L 45 H 36 P 50,4 cestone apertura tip-on	EBL75450
2	Elemento "UNICODE" L 90 H 36	ECODEU03609 328
1	Top living L 135 H 2,2 P 50,4 in melaminico come anta	al ml TLE225
1	Asta appendipensili ml 2	08610501

No. of ELEMENTS	DESCRIPTION	CODE
2	Wall unit W 45 H 72 D 33,4 glass door, push-pull opening with glass shelf	G1012451/2
2	Light "VIVARA 8" L&S W 45 for glass shelf	08618353
1	Power cable MC DRIVER L&S	08618020
1	Power supply module MC DRIVER L&S	08618000
1	Distributor module L&S	08618025
1	Wall unit W 45 H 96 D 33,4 push-pull opening	E2020451/2
1	Melamine open unit W 90 H 24 same colours as door 2 compartments	E77U0004
2	Hanging living base unit W 45 H 36 D 50,4 deep drawer tip-on opening, side same as door	EBL75450
1	Hanging living base unit W 45 H 36 D 50,4 deep drawer tip-on opening	EBL75450
2	"UNICODE" unit L 90 H 36	ECODEU03609 328
1	Melamine living worktop W 135 H 2,2 D 50,4 same as door	per lm TLE225
1	Wall unit fixing strip lm 2	08610501



# LIVING UN02



ANTA  
door



ELEMENTI A GIORNO  
open units



STRUTTURA  
carcass



ANTA VETRO  
TELAIO SILVER DARK  
VETRO TRASPARENTE  
glass doors  
dark silver frame  
trasparent glass

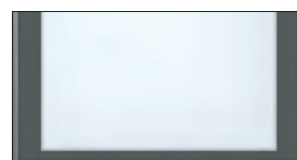



# LIVING UN02

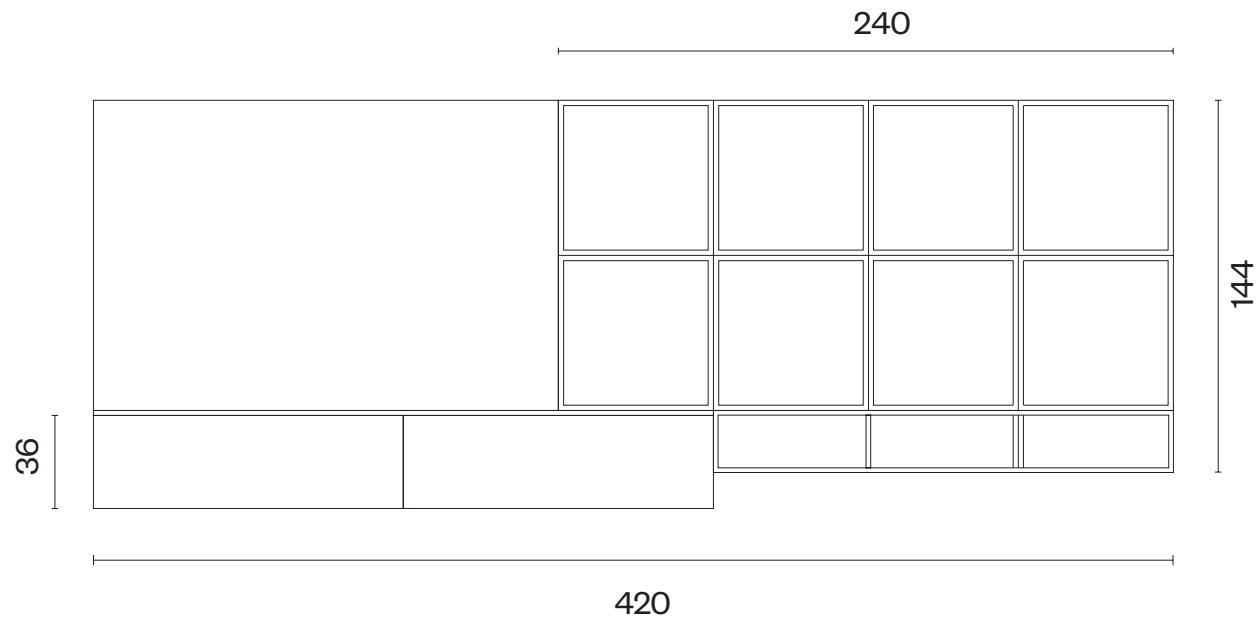

NR. ELEMENTI	DESCRIZIONE	CODICE
8	Pensile vetro L 60 H 60 P 33,4 telaio alluminio, apertura push-pull e ripiano vetro	G1062601/2
8	Luce "VIVARA 8" L&S L 60 per ripiano vetro	08618354
1	Cavo alimentazione MC DRIVER L&S	08618020
1	Trasformatore MC DRIVER L&S	08618003
1	Distributore L&S	08618025
1	Elemento a giorno L 120 H 24 2 vani in melaminico come anta	E77U0004
1	Elemento a giorno L 60 H 24 in melaminico come anta	E77U0002
2	Base living sospesa L 120 H 36 P 50,4 cestone apertura tip-on, fianco come anta	EBL76200
1	Top living L 240 H 2,2 P 50,4 in melaminico come anta	al ml TLE225
1	Schienale L 180 H 96 SP. 2,2 in melaminico come anta	al mq 094511
4	Asta appendipensili ml 2	08610501

No. of ELEMENTS	DESCRIPTION	CODE
8	Glass wall unit W 60 H 60 D 33,4 aluminum frame push-pull opening with glass shelf	G1062601/2
8	Light "VIVARA 8" L&S W 60 for glass shelf	08618354
1	Power cable MC DRIVER L&S	08618020
1	Power supply module MC DRIVER L&S	08618003
1	Distributor module L&S	08618025
1	Melamine open unit W 120 H 24 same colors as door 2 compartments	E77U0004
1	Melamine open unit W 60 H 24 same colors as door	E77U0002
2	Hanging living base unit W 120 H 36 D 50,4 deep drawer tip-on opening, side same as door	EBL76200
1	Melamine living worktop W 240 H 2,2 D 50,4 same as door	per lm TLE225
1	Melamine back panel W 180 H 96 TH. 2,2 same as door	per m <sup>2</sup> 094511
4	Wall unit fixing strip lm 2	08610501

# LIVING UN03



ANTA  
door



MENSOLA KOMPO  
KOMPO SHELF



STRUTTURA  
carcass

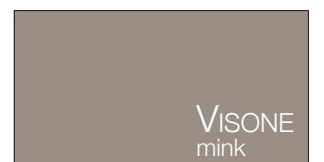

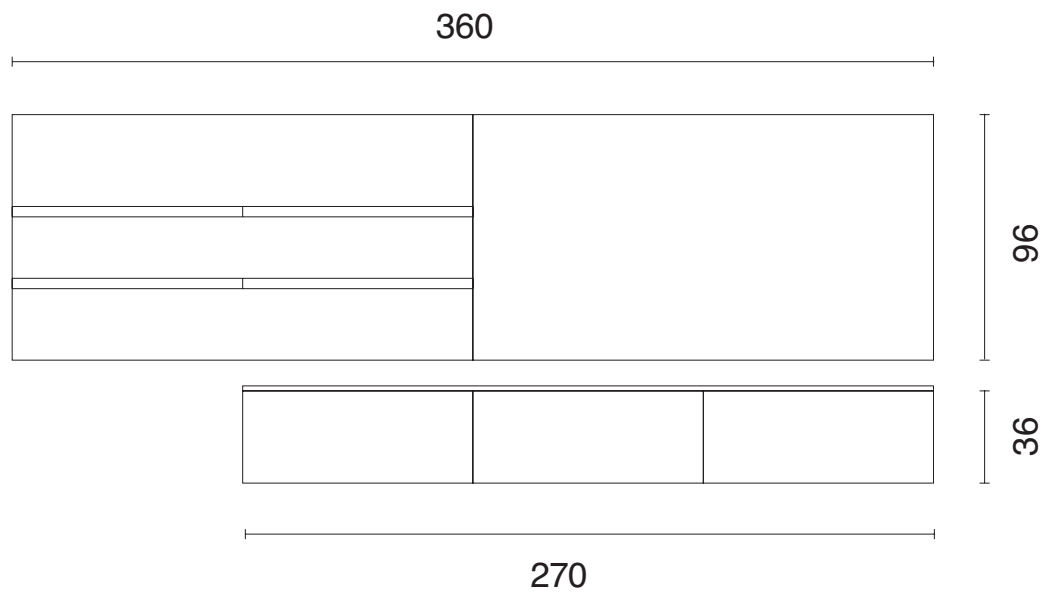

NR. ELEMENTI	DESCRIZIONE	CODICE
2	Base living sospesa L 90 H 36 P 50,4 cestone apertura tip-on, fianco come anta	EBL75900
1	Base living sospesa L 90 H 36 P 50,4 cestone apertura tip-on	EBL75900
1	Top living L 270 H 2,2 P 50,4 in melaminico come anta	al ml TLE225
4	Mensola Kompo in lamiera verniciata L 90 H 63 P 33,6 con luce	03993722
2	Schienale L 180 H 96 SP. 2,2 in melaminico come anta	al mq 094511
<b>TOTALE</b>		

No. of ELEMENTS	DESCRIPTION	CODE
2	Hanging living base unit W 90 H 36 D 50,4 deep drawer tip-on opening, side same as door	EBL75900
1	Hanging living base unit W 90 H 36 D 50,4 deep drawer tip-on opening	EBL75900
1	Melamine living worktop W 270 H 2,2 D 50,4 same as door	per lm TLE225
4	Painted sheet shelf Kompo W 90 H 63 D 33,6 with light	03993722
2	Melamine back panel W 180 H 96 TH. 2,2 same as door	per m <sup>2</sup> 094511
<b>TOTAL</b>		



# LIVING UN04



ANTE  
doors



ELEMENTI A GIORNO  
open units

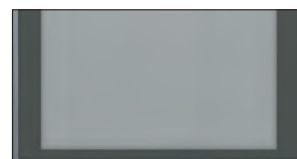
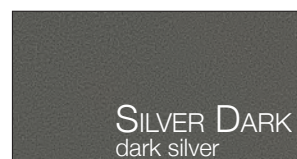

ANTA VETRO  
TELAIO SILVER DARK  
VETRO FUMÈ SATINATO  
glass doors  
dark silver frame  
smoked satin glass

STRUTTURA  
carcass



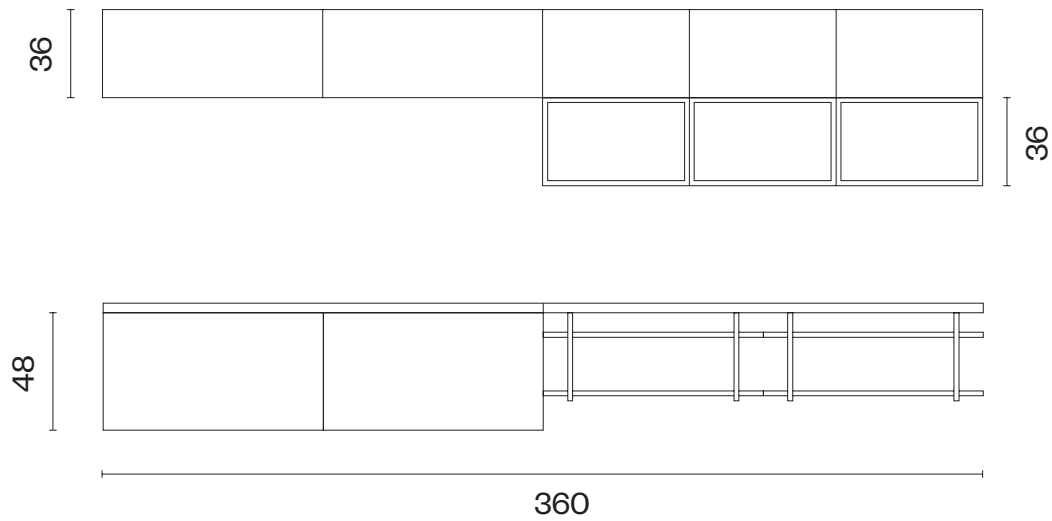

NR. ELEMENTI	DESCRIZIONE	CODICE
1	Pensile L 90 H 36 P 33,4 apertura tip-on, fianco come anta	E210090T
1	Pensile L 90 H 36 P 33,4 apertura tip-on	E210090T
2	Pensile L 60 H 36 P 33,4 apertura tip-on	E210060T
1	Pensile L 60 H 36 P 33,4 apertura tip-on, fianco come anta	E210060T
3	Pensile vetro L 60 H 36 P 33,4 telaio alluminio, apertura tip-on	G110260T
2	Pensile L 90 H 48 P 33,4 apertura winch, fianco come anta	E2123900
2	Elemento "UNICODE" L 90 H 36 P 31	ECODEU03609
2	Mensola L 180 H 4 P 33,4 in melaminico come anta	al ml 091527
4	Asta appendipensili ml 2	08610501

No. of ELEMENTS	DESCRIPTION	CODE
1	Wall unit W 90 H 36 D 33,4 tip-on opening side same as door	E210090T
1	Wall unit W 90 H 36 D 33,4 tip-on opening	E210090T
2	Wall unit W 60 H 36 D 33,4 tip-on opening	E210060T
1	Wall unit W 60 H 36 D 33,4 tip-on opening side same as door	E210060T
3	Glass wall unit W 60 H 36 D 33,4 aluminum frame tip-on opening	G110260T
2	Wall unit W 90 H 48 D 33,4 winch opening side same as door	E2123900
2	"UNICODE" unit L 90 H 36 D 31	ECODEU03609
2	Melamine shelf W 180 H 4 D 33,4 same as door	per lm 091527
4	Wall unit fixing strip lm 2	08610501



# LIVING UN05



ANTE  
doors



ECRU  
ecru



PIETRA MUSK  
musk stone

ELEMENTI A GIORNO  
open units



ECRU  
ecru

MENSOLA KOMPO  
KOMPO SHELF



ECRU  
ecru

STRUTTURE  
carcasses



VISONE  
mink

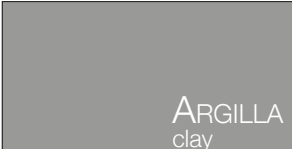

ARGILLA  
clay

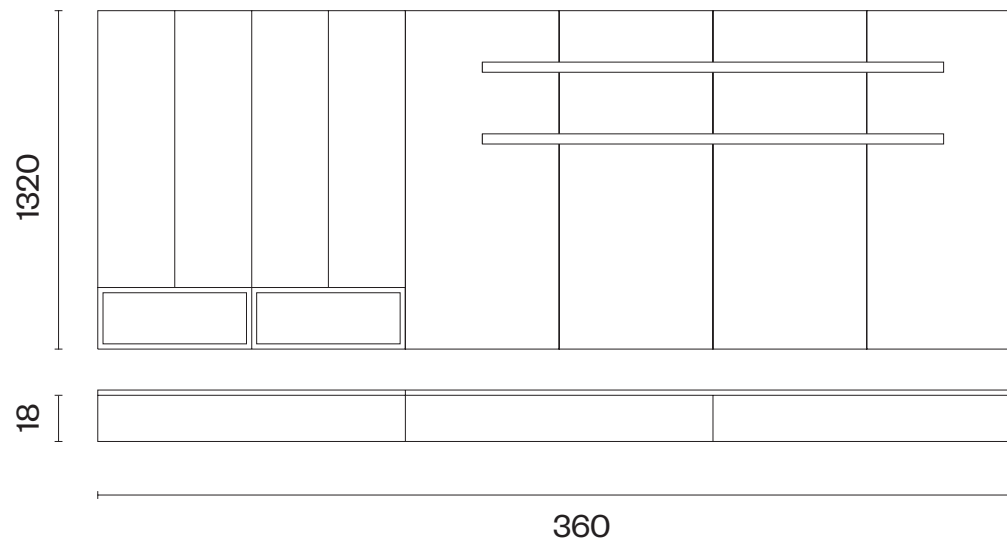

NR. ELEMENTI	DESCRIZIONE	CODICE
2	Pensile L 30 H 120 P 33,4 apertura push pull, fianco come anta	E2145301/2
2	Pensile L 30 H 120 P 33,4 apertura push pull	E2145301/2
1	Elemento a giorno L 120 H 24 P 31 in melaminico come anta	E77U0004
2	Base living L 120 H 18 P 50,4 cassetto apertura tip-on, fianco come anta	EBL04200
1	Base living L 120 H 18 P 50,4 cassetto apertura tip-on	EBL04200
4	Schienale L 60 H 132 SP. 2,2 in melaminico come anta	al mq 094511
4	Mensola Kompo in lamiera verniciata L 90 H 63 P 33,6 con luce	03993722
1	Top living L 120 P 50,4 SP. 2,2 in melaminico come anta	al ml TLE225
1	Top living L 240 P 50,4 SP. 2,2 in melaminico come anta	al ml TLE225
1	Asta appendipensili ml 2	08610501

No. of ELEMENTS	DESCRIPTION	CODE
2	Wall unit W 30 H 120 D 33,4 push pull opening, side same as door	E2145301/2
2	Wall unit W 30 H 120 D 33,4 push pull opening	E2145301/2
1	Melamine open unit W 120 H 24 D 31 same as door	E77U0004
2	Living base unit W 120 H 18 D 50,4 drawer tip-on opening, side same as door	EBL04200
1	Living base unit W 120 H 18 D 50,4 drawer tip-on opening	EBL04200
4	Melamine back panel W 60 H 132 TH. 2,2 same as door	per m <sup>2</sup> 094511
4	Painted sheet shelf Kompo W 90 H 63 D 33,6 with light	03993722
1	Melamine living worktop W 120 D 50,4 TH. 2,2 same as door	per lm TLE225
1	Melamine living worktop W 240 D 50,4 TH. 2,2 same as door	per lm TLM225
1	Wall unit fixing strip lm 2	08610501



# LIVING UN06



ANTA  
door

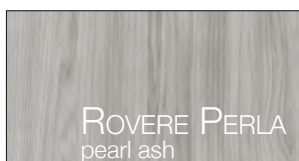

ELEMENTI A GIORNO  
open units



STRUTTURA  
carcass

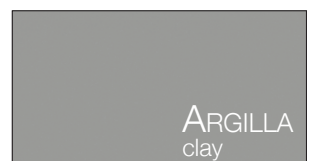

ANTA VETRO  
TELAIO GRIGIO SELCE  
VETRO BRONZO SATINATO  
glass doors  
flint grey frame  
bronze satin glass

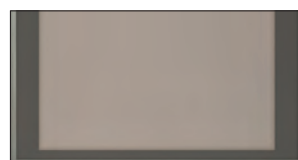

# LIVING UN06

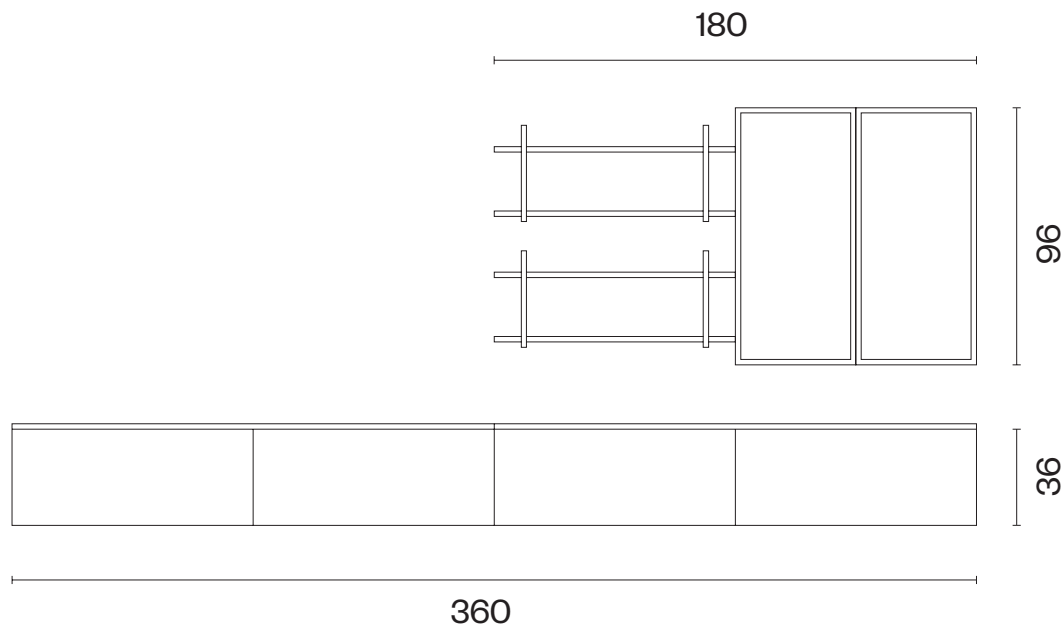

NR. ELEMENTI	DESCRIZIONE	CODICE
2	Pensile vetro L 45 H 96 P 33,4 telaio alluminio, apertura push-pull e ripiano vetro	G1022451/2
4	Luce "VIVARA 8" L&S L 45 per ripiano vetro	08618353
1	Cavo alimentazione MC DRIVER L&S	08618020
1	Trasformatore MC DRIVER L&S	08618001
1	Distributore L&S	08618025
2	Base living sospesa L 90 H 36 P 50,4 cestone apertura tip-on, fianco come anta	EBL75900
2	Base living sospesa L 90 H 36 P 50,4 cestone apertura tip-on	EBL75900
2	Top living L 180 H 2,2 P 50,4 in melaminico come anta	al ml TLE225
2	Elemento "UNICODE" L 90 H 36 P 31	ECODEU03609 328
1	Asta appendipensili ml 2	08610501
<b>TOTALE</b>		

No. of ELEMENTS	DESCRIPTION	CODE
2	Glass wall unit W 45 H 96 D 33,4 aluminum frame push-pull opening with glass shelves	G1022451/2
4	Light "VIVARA 8" L&S W 45 for glass shelf	08618353
1	Power cable MC DRIVER L&S	08618020
1	Power supply module MC DRIVER L&S	08618001
1	Distributor module L&S	08618025
2	Hanging living base unit W 90 H 36 D 50,4 deep drawer tip-on opening, side same as door	EBL75900
2	Hanging living base unit W 90 H 36 D 50,4 deep drawer tip-on opening	EBL75900
2	Melamine living worktop W 180 TH. 2,2 D 50,4 same as door	per lm TLE225
2	"UNICODE" unit L 90 H 36 D 31	ECODEU03609
1	Wall unit fixing strip lm 2	08610501



## COMPOSIZIONE L 305

COMPOSITION W 305



## COMPOSIZIONE L 423

COMPOSITION W 423



## COMPOSIZIONE L 305

COMPOSITION W 305

### COMPONENTI COMPONENTS

**Colonna 60 H 217 frigo-freezer 230 classe A+ con gola verticale e fianco come anta**

60 cm column H 217 fridge-freezer 230 class "A+" with vertical groove as doors and side

**Base 60**

60 cm base unit

**Base 60 forno multifunzione inox**

60 cm base unit for stainless steel multifunctional oven

**Piano cottura 60 4 gas inox con valvola**

60 cm stainless steel hob with 4 burners with safety valve

**Base 60 2 cassetti e cestone**

60 cm base unit with 2 drawers and deep drawer

**Sottolavello 60**

60 cm sink unit

**Lavello ad incasso 86 x 50 1 vasca inox**

86x50 cm built-in sink with 1 stainless steel bowl

**Top 240 P 61 in laminato H 4**

240 cm laminate worktop D 61 H 4

**Pensile 60 H 72**

60 cm wall unit H 72

**Cappa 60 "Mod. 29" H 72**

60 cm hood "Mod.29" H 72

**Pensile 60 H 72**

60 cm wall unit H 72

**Scolapiatti 60 H 72**

60 cm plate rack H 72

**Asta appendipensili ml 4**

4 lm wall unit fixing strip

**(Elettrodomestici Hotpoint )**  
(Hotpoint appliances)

### VERSIONI VERSIONS

#### LUX

**fascia "A"**

band "A"

**fascia "B"**

band "B"

#### NECK

**fascia "A"**

band "A"

**fascia "B"**

band "B"

**con maniglia fascia "A"**

with handle band "A"

**con maniglia fascia "B"**

with handle band "B"

## COMPOSIZIONE L 423

COMPOSITION W 423

### COMPONENTI COMPONENTS

**Colonna 60 H 217 frigo-freezer 315 classe A+**

60 cm column H 217 fridge-freezer 315 class "A+"

**Colonna 60 H 217 forno multifunzione inox**

60 cm column H 217 for stainless steel multifunctional oven

**Base 60**

60 cm base unit

**Piano cottura 75 5 gas inox con valvola**

75 cm stainless steel hob with 5 burners with safety valve

**Base 90 2 cassetti e cestone predisposta piano cottura**

90 cm base unit with 2 drawers and deep drawers configured for hob

**Base 60**

60 cm base unit

**Sottolavello 90**

90 cm sink unit

**Lavello ad incasso 86 x 50 1 vasca inox**

86x50 cm built-in sink with 1 stainless steel bowl

**Top 300 P 61 in laminato H 4**

300 cm laminate worktop D 61 H 4

**Pensile 60 H 72**

60 cm wall unit H 72

**Cappa 90 "STILO SMART" inox**

90 cm "STILO SMART" stainless steel hood

**Pensile 60 H 72**

60 cm wall unit H 72

**Scolapiatti 90 H 72**

90 cm plate rack H 72

**Asta appendipensili ml 4**

4 lm wall unit fixing strip

**(Elettrodomestici Hotpoint)**  
(Hotpoint appliances)

### VERSIONI VERSIONS

#### LUX

**fascia "A"**

band "A"

**fascia "B"**

band "B"

#### NECK

**fascia "A"**

band "A"

**fascia "B"**

band "B"

**con maniglia fascia "A"**

with handle band "A"

**con maniglia fascia "B"**

with handle band "B"



## COMPOSIZIONE L 300

COMPOSITION W 300



## COMPOSIZIONE L 420

COMPOSITION W 420



## COMPOSIZIONE L 300

COMPOSITION W 300

### COMPONENTI COMPONENTS

#### Colonna 60 H 217 frigo-freezer 230 classe A+

60 cm column H 217 fridge-freezer 230 class "A+"

#### Base 60

60 cm base unit

#### Base 60 forno multifunzione inox

60 cm base unit for stainless steel multifunctional oven

#### Piano cottura 60 4 gas inox con valvola

60 cm stainless steel hob with 4 burners with safety valve

#### Base 60 2 cassetti e cestone

60 cm base unit with 2 drawers and deep drawer

#### Sottolavello 60

60 cm sink unit

#### Lavello ad incasso 86 x 50 1 vasca inox

86x50 cm built-in sink with 1 stainless steel bowl

#### Top 240 P 61 in laminato H 4

240 cm laminate worktop D 61 H 4

#### Pensile 60 H 72

60 cm wall unit H 72

#### Cappa 60 aspirante estraibile H 63

60 cm hood slide-out ducting H 63

#### Pensile 60 H 72

60 cm wall unit H 72

#### Scolapiatti 60 H 72

60 cm plate rack H 72

#### Asta appendipensili ml 4

4 lm wall unit fixing strip

**(Elettrodomestici Hotpoint )**  
(Hotpoint appliances)

### VERSIONI VERSIONS

#### BRIDGE

#### fascia "A"

band "A"

#### fascia "B"

band "B"

#### HEAD

#### fascia "A"

band "A"

#### fascia "B"

band "B"

## COMPOSIZIONE L 420

COMPOSITION W 420

### COMPONENTI COMPONENTS

#### Colonna 60 H 217 frigo-freezer 315 classe A+

60 cm column H 217 fridge-freezer 315 class "A+"

#### Colonna 60 H 217 forno multifunzione inox

60 cm column H 217 for stainless steel multifunctional oven

#### Base 60

60 cm base unit

#### Piano cottura 75 5 gas inox con valvola

75 cm stainless steel hob with 5 burners with safety valve

#### Base 90 2 cassetti e cestone predisposta piano cottura

90 cm base unit with 2 drawers and deep drawers configured for hob

#### Base 60

60 cm base unit

#### Sottolavello 90

90 cm sink unit

#### Lavello ad incasso 86 x 50 1 vasca inox

86x50 cm built-in sink with 1 stainless steel bowl

#### Top 300 P 61 in laminato H 4

300 cm laminate worktop D 61 H 4

#### Pensile 60 H 72

60 cm wall unit H 72

#### Cappa 90 "STILO SMART" inox

90 cm "STILO SMART" stainless steel hood

#### Pensile 60 H 72

60 cm wall unit H 72

#### Scolapiatti 90 H 72

90 cm plate rack H 72

#### Asta appendipensili ml 4

4 lm wall unit fixing strip

**(Elettrodomestici Hotpoint)**  
(Hotpoint appliances)

### VERSIONI VERSIONS

#### BRIDGE

#### fascia "A"

band "A"

#### fascia "B"

band "B"

#### HEAD

#### fascia "A"

band "A"

#### fascia "B"

band "B"